



International Isotopes Fluorine Products

International Isotopes Fluorine Products, Inc.
(IIFP)

A Wholly Owned Subsidiary of
International Isotopes, Inc.

Fluorine Extraction Process &
Depleted Uranium De-conversion
Plant (FEP/DUP)

Environmental Report

Revision A

December 27, 2009

ABSTRACT

This Environmental Report (ER) constitutes one portion of an application being submitted by International Isotopes Fluorine Products (IIFP) to construct and operate a facility that will utilize depleted DUF_6 to produce high purity inorganic fluorides, uranium oxides, and anhydrous hydrofluoric acid. The proposed IIFP facility will be located near Hobbs, New Mexico. IIFP has prepared the ER to meet the requirements specified in 10 CFR 51, Subpart A, particularly those requirements set forth in 10 CFR 51.45(b)-(e). The organization of this ER is generally consistent with NUREG-1748, "Environmental Review Guidance for Licensing Actions Associated with NMSS Programs, Final Report."

The Environmental Report for this proposed facility provides information that is specifically required by the NRC to assist it in meeting its obligations under the *National Environmental Policy Act (NEPA) of 1969* and the agency's NEPA-implementing regulations. This ER demonstrates that the environmental protection measures proposed by IIFP are adequate to protect both the environment and the health and safety of the public.

This Environmental Report evaluates the potential environmental impacts of the Proposed Action and its reasonable alternatives. This ER also describes the environment potentially affected by IIFP's proposal, presents and compares the potential environmental impacts resulting from the Proposed Action and its alternatives, and describes IIFP's environmental monitoring program and proposed mitigation measures.

TABLE OF CONTENTS

ABSTRACT	ii
TABLE OF CONTENTS.....	iii
LIST OF APPENDICES	xvi
LIST OF FIGURES	xvii
LIST OF TABLES	xx
EXECUTIVE SUMMARY	xxiv
Proposed Action.....	xxiv
Need for Proposed Action.....	xxv
Comparison of Alternatives	xxv
Conclusion	xxvi
ACRONYMS and ABBREVIATIONS	xxvii
1. INTRODUCTION.....	1-1
1.1 General Description of the IIFP Facility and Proposed Action	1-2
1.2 Purpose and Need for Proposed Action	1-5
1.2.1 Need for Proposed Action.....	1-6
1.2.2 Applicant for the Proposed Action	1-6
1.2.3 Projected Construction and Operational Startup Schedules	1-7
1.3 Basis of the IIFP Facility Design and Technology	1-7
1.3.1 Background.....	1-7
1.3.2 Facility Environmental Design Philosophy	1-8
1.3.2.1 Design Basis and Philosophy for Minimum Environmental Impact....	1-9
1.3.2.2 Design Basis Standards and Codes	1-10
1.3.3 The Proposed Site	1-11
1.4 Applicable Regulatory Requirements and Status.....	1-13
1.4.1 Federal Agencies.....	1-14
1.4.1.1 <i>National Environmental Policy Act</i>	1-14
1.4.1.2 <i>Atomic Energy Act</i>	1-14
1.4.1.3 <i>Clean Air Act</i>	1-15
1.4.1.4 <i>Clean Water Act</i>	1-15
1.4.1.5 <i>Resource Conservation and Recovery Act</i>	1-15
1.4.1.6 <i>Low-Level Radioactive Waste Policy Act</i>	1-16
1.4.1.7 <i>Emergency Planning and Community Right-to-Know Act</i>	1-16
1.4.1.8 <i>Safe Drinking Water Act</i>	1-16
1.4.1.9 <i>Noise Control Act</i>	1-17
1.4.1.10 <i>National Historic Preservation Act</i>	1-17
1.4.1.11 <i>Endangered Species Act</i>	1-17
1.4.1.12 <i>Occupational Safety and Health Act</i>	1-17
1.4.1.13 <i>Hazardous Materials Transportation Act</i>	1-17
1.4.1.14 Environmental Standards for Uranium Fuel Cycle	1-18
1.4.1.15 National Emission Standards for Hazardous Air Pollutants	1-18
1.4.2 Applicable Executive Orders	1-18
1.4.2.1 <i>Executive Order 11514</i>	1-18
1.4.2.2 <i>Executive Order 11988</i>	1-18
1.4.2.3 <i>Executive Order 12898</i>	1-18
1.4.2.4 <i>Executive Order 13007</i>	1-19
1.4.2.5 <i>Executive Order 13175</i>	1-19

1.4.3	Involved Federal Agencies	1-19
1.4.3.1	Nuclear Regulatory Commission	1-19
1.4.3.2	U.S. Environmental Protection Agency	1-19
1.4.3.3	U.S. Department of Transportation	1-20
1.4.3.4	U.S. Army Corps of Engineers	1-21
1.4.3.5	Occupational Safety and Health Administration.....	1-21
1.4.3.6	U.S. Department of Interior	1-21
1.4.4.	State Agencies	1-21
1.4.4.1	<i>New Mexico Air Quality Control Act</i>	1-21
1.4.4.2	<i>New Mexico Radiation Protection Act</i>	1-21
1.4.4.3	<i>New Mexico Water Quality Act</i>	1-21
1.4.4.4	<i>New Mexico Groundwater Protection Act</i>	1-22
1.4.4.5	<i>New Mexico Hazardous Waste Act</i>	1-22
1.4.4.6	<i>New Mexico Hazardous Chemicals Information Act</i>	1-22
1.4.4.7	<i>New Mexico Wildlife Conservation Act</i>	1-22
1.4.4.8	<i>New Mexico Raptor Protection Act</i>	1-22
1.4.4.9	<i>New Mexico Endangered Plant Species Act</i>	1-23
1.4.4.10	<i>Threatened and Endangered Species of New Mexico</i>	1-23
1.4.4.11	Endangered Plant Species	1-23
1.4.4.12	Transportation and Highway	1-23
1.4.4.13	State Trust Lands Land Exchanges	1-23
1.4.4.14	<i>New Mexico Cultural Properties Act</i>	1-23
1.4.4.15	Registration of Tanks	1-23
1.4.4.16	<i>New Mexico Night Sky Protection Act</i>	1-23
1.4.4.17	New Mexico Occupational Safety and Health	1-24
1.4.4.18	<i>Environmental Improvement Act - Drinking Water Regulations</i>	1-24
1.4.5	Involved State Agencies	1-24
1.4.5.1	New Mexico Air Quality Bureau	1-24
1.4.5.2	New Mexico Water Quality Bureau.....	1-25
1.4.5.3	New Mexico Hazardous Waste Bureau	1-26
1.4.5.4	New Mexico State Land Office.....	1-26
1.4.5.5	New Mexico Department of Game and Fish.....	1-26
1.4.5.6	New Mexico Energy, Minerals and Natural Resources	1-27
	Department	1-27
1.4.5.7	New Mexico Radiological Control Bureau.....	1-27
1.4.5.8	New Mexico State Historic Preservation Office	1-27
1.4.5.9	New Mexico Office of the State Engineer	1-27
1.4.6	Support from Local Agencies	1-27
1.4.7	Surveys Conducted	1-28
1.5	Building Permits and Licenses.....	1-31
2	ALTERNATIVES	2-1
2.1	Proposed Action.....	2-1
2.1.1	Proposed Site and Location	2-2
2.1.2	Site Construction.....	2-4
2.1.3	Process Description of the Proposed Action.....	2-5
2.1.3.1	Process Chemistry	2-5
2.1.3.2	De-conversion of DUF ₆ to DUF ₄	2-6
2.1.3.3	SiF ₄ Production	2-7
2.1.3.4	BF ₃ Production	2-8
2.1.3.5	De-conversion of DUF ₆ Directly to Oxide.....	2-10

2.1.3.6	Process Off-gas Emissions Treatment (Plant KOH Scrubbing System).....	2-11
2.1.3.7	Environmental Protection Process (EPP).....	2-13
2.1.3.8	AHF Staging Containment Building and Fluoride Products Trailer Loading Building	2-14
2.1.3.9	Process Vent Stacks	2-16
2.1.4	Overview of the Facility and Description of Infrastructure.....	2-19
2.1.4.1	Process Buildings and Process Areas.....	2-23
2.1.4.2	Utilities Requirements	2-24
2.1.4.3	Equipment Support Pads and Spill Containment.....	2-28
2.1.4.4	Water Treatment.....	2-28
2.1.4.5	Sewer Systems and Collection Basins	2-29
2.1.4.6	Fire Protection.....	2-30
2.1.4.7	Other Major Buildings	2-30
2.1.4.8	Monitoring Stations.....	2-32
2.1.5	Decommissioning	2-32
2.2	Alternatives for Site Selection	2-33
2.2.1	Methodology.....	2-33
2.2.1.1	Solicitation of Interest and First-Phase Screening	2-33
2.2.1.2	Second-Phase Screening	2-33
2.2.1.3	Cost-Evaluation Results	2-35
2.2.2	Final Site Selection	2-36
2.3	No Action Alternative.....	2-38
2.4	Reasonable Alternative Actions.....	2-41
2.4.1	Reasonable Alternative for De-conversion of DUF ₆	2-41
2.5	Alternative Technology	2-42
2.6	Cumulative Effects	2-42
2.7	Comparison of Predicted Environmental Impacts	2-43
2.7.1	Comparison of the Impacts of the No-Action Alternative and the Proposed Action	2-43
2.7.1.1	Summary of Expected Impacts from Operation of the Paducah	2-44
2.7.1.2	Environmental Impacts from Transportation of Radioactive Material	2-44
2.7.2	Comparison of the Impacts of the Reasonable Alternatives and the Proposed Action	2-47
2.7.2.1	Shipping Material Overseas for De-Conversion	2-47
2.7.2.2	Constructing Their Own De-conversion Facilities.....	2-48
2.7.2.3	Utilizing the DOE Facilities with Installation of Additional Capacity.....	2-48
3.	DESCRIPTION OF THE ENVIRONMENT AFFECTED.....	3-1
3.1	Land Use.....	3-1
3.1.1	Land Use Status	3-2
3.1.2	Description of Off-site Areas.....	3-4
3.1.3	Mineral Resources	3-7
3.1.4	Unusual Animals.....	3-8
3.2	Transportation.....	3-9
3.2.1	Access Transportation.....	3-9
3.2.2	Transportation Modes and Routes	3-11
3.2.2.1	Pre-Licensing Construction and Facility Construction Phases	3-11
3.2.2.2	Facility Operation Phase	3-11

3.2.3	Land Use Transportation Restrictions	3-13
3.3	Geology and Soils	3-13
3.3.1	Seismology	3-17
	3.3.1.1 Seismic History of the Region and Vicinity.....	3-18
	3.3.1.2 Correlation of Seismicity with Tectonic Features.....	3-23
3.3.2	Site Soils	3-23
3.4	Water Resources	3-27
3.4.1	Surface Hydrology	3-27
	3.4.1.1 Major Surface and Subsurface Hydrological Systems	3-28
	3.4.1.2 Facility Withdrawals and/or Discharges to Hydrologic Systems.....	3-30
3.4.2	Water Quality Characteristics	3-30
3.4.3	Pre-Existing Environmental Conditions	3-30
3.4.4	Historical and Current Hydrological Data	3-30
3.4.5	Water Rights and Resources	3-31
3.4.6	Quantitative Description of Water Use.....	3-31
3.4.7	Non-Consumptive Water Use	3-32
3.4.8	Contaminant Sources	3-32
3.4.9	Description of Wetlands	3-32
3.4.10	Federal and State Regulations.....	3-33
3.4.11	Surface Water Characteristics for Relevant Water Bodies	3-33
	3.4.11.1 Freshwater Streams, Lakes, Impoundments.....	3-33
	3.4.11.2 Flood Frequency Distributions.....	3-33
	3.4.11.3 Floodplain Description/Flood Control Measures	3-34
	3.4.11.4 Design-Basis Flood Elevation.....	3-34
	3.4.11.5 Location, Size and Elevation of Outfall.....	3-34
	3.4.11.6 Velocity Distribution and Water-body Cross Section within	3-34
	Influence of Outfall	3-34
	3.4.11.7 Bathymetry Near any Outfall	3-34
	3.4.11.8 Erosion Characteristics and Sediment Transport	3-34
3.4.12	Freshwater Streams for the Watershed Containing the Site	3-34
	3.4.12.1 Major Streams	3-34
	3.4.12.2 Drainage Areas.....	3-35
	3.4.12.3 Historical Maximum and Minimum River Flows	3-35
	3.4.12.4 Historical Drought River Flows	3-35
	3.4.12.5 Important Short-Duration Flows	3-35
3.4.13	Lakes and Impoundments	3-36
	3.4.13.1 Elevation-Area-Capacity Curves.....	3-36
	3.4.13.2 Reservoir Operating Rules	3-36
	3.4.13.3 Annual Yield and Dependability.....	3-36
	3.4.13.4 Inflow/Outflow/Storage Variations.....	3-36
	3.4.13.5 Net Loss, Including Evaporation and Seepage.....	3-36
	3.4.13.6 Current Patterns.....	3-36
	3.4.13.7 Temperature Distribution	3-37
3.4.14	Estuaries and Oceans	3-37
3.4.15	Groundwater Characteristics.....	3-37
	3.4.15.1 Groundwater Elevation Trends	3-37
	3.4.15.2 Water Table Contours	3-39
	3.4.15.3 Depth of Water for Unconfined Aquifer Systems.....	3-41
	3.4.15.4 Soil Hydrologic Properties.....	3-41
	3.4.15.5 Flow Travel Time: Groundwater Velocity.....	3-41
	3.4.15.6 Interactions Among Different Aquifers	3-43

	3.4.15.7 Historical and Current Data from Site Wells	3-43
3.5	Ecological Resources	3-43
	3.5.1 Maps	3-44
	3.5.2 General Ecological Conditions of the Site.....	3-44
	3.5.3 Major Vegetation Characteristics	3-46
	3.5.4 Habitat Importance	3-50
	3.5.5 Listing of Rare, Threatened or Endangered (RTE) Species Known or	
	Potentially Occurring in the Project Area.....	3-51
	3.5.6 Inter-specific Relationships Resulting in Decline of These RTE Species	3-51
	3.5.7 Description of RTE Species Known or Potentially Occurring in the Project	
	Area.....	3-53
	3.5.7.1 Lesser Prairie Chicken	3-53
	3.5.7.2 Sand Dune Lizard.....	3-55
	3.5.7.3 Northern Aplomado Falcon.....	3-58
	3.5.7.4 Black-Footed Ferret	3-59
	3.5.7.5 American Peregrine Falcon.....	3-61
	3.5.7.6 Arctic Peregrine Falcon.....	3-62
	3.5.7.7 Baird's Sparrow	3-63
	3.5.7.8 Bell's Vireo.....	3-64
	3.5.7.9 Western Burrowing Owl	3-66
	3.5.7.10 Yellow-Billed Cuckoo	3-67
	3.5.7.11 Black-Tailed Prairie Dog	3-68
	3.5.7.12 Swift Fox.....	3-70
	3.5.8 Location of Important Travel Corridors	3-71
	3.5.9 Important Ecological Systems	3-72
	3.5.10 Characterization/Significance of the Aquatic Environment	3-72
	3.5.11 Location and Value of Commercial and Sport Fisheries	3-72
	3.5.12 Key Aquatic Organism Indicators	3-72
	3.5.13 Importance/Significance of Ecological Systems	3-72
	3.5.14 Description of Conditions Indicative of Stress	3-73
	3.5.15 Description of Ecological Succession.....	3-73
	3.5.16 Description of Ecological Studies/Habitat Modeling	3-74
	3.5.17 Information of RTE Sightings	3-77
	3.5.18 Agency Consultation.....	3-77
3.6	Meteorology, Climatology and Air Quality.....	3-77
	3.6.1 On-site Meteorological Conditions.....	3-77
	3.6.1.1 Regional Climate.....	3-77
	3.6.1.2 Temperature	3-77
	3.6.1.3 Precipitation	3-80
	3.6.1.4 Wind.....	3-83
	3.6.1.5 Atmospheric Stability.....	3-86
	3.6.1.6 Storms	3-87
	3.6.1.7 Mixing Heights	3-89
	3.6.1.8 Sandstorms	3-90
	3.6.2 Existing Levels of Air Pollution and Effects on Plant Operations	3-90
	3.6.3 Impact of the Local Terrain and Bodies of Water on Meteorological	
	Conditions.....	3-92
3.7	Noise	3-94
	3.7.1 Extent of Noise Analysis	3-94
	3.7.2 Community Distribution	3-94
	3.7.3 Background Noise Levels	3-95

	3.7.4	Topography and Land Use.....	3-95
	3.7.5	Meteorological Conditions	3-96
	3.7.6	Sound Level Standards	3-97
3.8		Historic and Cultural Resources	3-98
	3.8.1	Known Cultural Resources in the Area	3-98
	3.8.2	Archaeological or Historical Surveys	3-98
		3.8.2.1 Physical Extent of the Survey	3-98
		3.8.2.2 Description of Survey Techniques	3-100
		3.8.2.3 Cultural Resource Specialist Qualifications.....	3-100
		3.8.2.4 Survey Findings	3-100
	3.8.3	List of Historical and Cultural Properties	3-102
	3.8.4	Agency Consultation.....	3-102
	3.8.5	Statement of Site Significance	3-102
3.9		Visual/Scenic Resources	3-102
	3.9.1	Viewshed Boundaries	3-102
	3.9.2	Site Photographs	3-102
	3.9.3	Affected Residents/Visitors	3-102
	3.9.4	Important Landscape Characteristics.....	3-102
	3.9.5	Location of Construction Features.....	3-104
	3.9.6	Access Road Visibility.....	3-104
	3.9.7	High Quality View Areas	3-106
	3.9.8	Viewshed Information	3-106
	3.9.9	Regulatory Information.....	3-106
	3.9.10	Aesthetic and Scenic Quality Rating	3-106
	3.9.11	Coordination with Local Planners	3-106
3.10		Socioeconomic.....	3-106
	3.10.1	Population Characteristics	3-109
		3.10.1.1 Population Levels in the Region of Influence.....	3-109
		3.10.1.2 Population Trends in the Region of Influence	3-110
		3.10.1.3 Lea County Population Levels	3-113
		3.10.1.4 Lea County Projected Population Growth	3-115
		3.10.1.5 Minority Population	3-116
	3.10.2	Economic Characteristics	3-117
		3.10.2.1 Historical Employment Trends for Lea County.....	3-117
		3.10.2.2 Employment, Jobs, and Occupational Patterns for the Region of Influence.....	3-119
		3.10.2.3 Employment, Jobs, and Occupational Patterns for Lea County.....	3-121
		3.10.2.4 Income.....	3-125
		3.10.2.5 Tax Structure.....	3-126
	3.10.3	Community Characteristics.....	3-127
		3.10.3.1 Housing	3-127
		3.10.3.2 Education in the Region of Influence.....	3-129
		3.10.3.3 Education in the Lea County	3-130
		3.10.3.4 Health Care, Public Safety, and Transportation Services	3-132
3.11		Public and Occupational Health.....	3-133
	3.11.1	Major Sources and Levels of Background Radiation	3-134
		3.11.1.1 Current Radiation Sources	3-136
		3.11.1.2 Historical Exposure to Radioactive Materials.....	3-136
		3.11.1.3 Summary of Health Effects	3-136
	3.11.2	Major Sources and Levels of Chemical Exposure	3-137
		3.11.2.1 Occupational Injury Rates.....	3-138

	3.11.2.2 Public and Occupational Exposure Limits	3-138
3.12	Waste Management.....	3-139
	3.12.1 Gaseous Waste Streams	3-140
	3.12.2 Solid Waste Management	3-140
	3.12.2.1 Construction Wastes.....	3-141
	3.12.2.2 Scrap Metal	3-141
	3.12.3 Process and Non-Process Waste Waters.....	3-142
4.	ENVIRONMENTAL IMPACTS	4-1
4.1	Land Use Impacts	4-1
4.1.1	Proposed Action.....	4-1
4.1.1.1	Construction Impacts	4-1
4.1.1.2	Utilities.....	4-4
4.1.1.3	Operations	4-4
4.1.1.4	Decommissioning.....	4-4
4.1.2	Cumulative Impacts	4-4
4.1.3	Control of Impacts	4-5
4.1.4	Comparative Land Use Impacts of Alternative Actions	4-5
4.1.4.1	No-Action Alternative.....	4-5
4.1.4.2	Reasonable Alternative Actions	4-6
4.2	Transportation Impacts	4-6
4.2.1	Transportation Mode.....	4-7
4.2.2	Transportation Route	4-7
4.2.3	Traffic Pattern	4-9
4.2.4	Proposed Action.....	4-9
4.2.4.1	Construction of Access Road	4-9
4.2.4.2	Construction	4-9
4.2.4.3	Operations	4-10
4.2.4.4	Decommissioning.....	4-11
4.2.5	Other Construction Transportation Impacts.....	4-11
4.2.6	Radioactive Material Transportation	4-12
4.2.6.1	Transportation Modes, Routes, and Distances	4-13
4.2.6.2	Radioactive Treatment and Packaging Procedure.....	4-14
4.2.6.3	Incident-Free Scenario Radiological Dose	4-14
4.2.6.4	Environmental Impacts from Severe Transportation Accidents of Radioactive Material	4-16
4.2.7	Cumulative Impacts	4-19
4.2.8	Impact Controls.....	4-20
4.2.9	Comparative Transportation Impacts of Alternative Actions	4-20
4.2.9.1	No-Action Alternative.....	4-20
4.2.9.2	Reasonable Alternate Actions	4-20
4.3	Geology and Soil Impacts.....	4-21
4.3.1	Geology Impacts	4-21
4.3.2	Soils Impacts.....	4-21
4.3.3	Site Preparation and Construction	4-22
4.3.4	Road Construction at the Proposed Site.....	4-22
4.3.5	Grading within the IIFP Site	4-22
4.3.6	Operations.....	4-22
4.3.7	Decommissioning	4-22
4.3.8	Cumulative Impacts to Site Soils.....	4-23
4.3.9	Impact Controls.....	4-23
4.3.10	Comparative Geology and Soil Impacts of Alternative Actions.....	4-23

	4.3.10.1 No-Action Alternative.....	4-23
	4.3.10.2 Reasonable Alternative Actions	4-24
4.4	Water Resources Impacts.....	4-24
	4.4.1 Receiving Waters.....	4-26
	4.4.2 Impacts on Surface Water and Groundwater Quality	4-26
	4.4.3 Hydrological System Alterations	4-26
	4.4.4 Hydrological System Impacts	4-27
	4.4.5 Ground and Surface Water Use	4-27
	4.4.6 Identification of Impacted Ground and Surface Water Users.....	4-27
	4.4.7 Control of Impacts to Water Quality	4-29
	4.4.8 Identification of Predicted Cumulative Effects on Water Resources	4-30
	4.4.9 Decommissioning	4-30
	4.4.10 Comparative Water Resources Impacts of Alternative Actions	4-31
	4.4.10.1 No-Action Alternative.....	4-31
	4.4.10.2 Reasonable Alternative Actions	4-31
4.5	Ecological Resources Impacts	4-32
	4.5.1 Maps	4-32
	4.5.2 Proposed Schedule of Activities	4-32
	4.5.3 Area of Disturbance/Site Preparation and Construction	4-32
	4.5.4 Construction Practices	4-32
	4.5.5 Operation	4-33
	4.5.6 Area of Disturbance by Habitat Type	4-33
	4.5.7 Maintenance Practices	4-33
	4.5.8 Short-Term Use Areas and Plans for Restoration.....	4-34
	4.5.9 Activities Expected to Impact Sensitive Communities or Habitats	4-34
	4.5.10 Impacts of Elevated Construction Equipment or Structures.....	4-36
	4.5.11 Tolerances and Susceptibilities of Important Biota to Pollutants	4-36
	4.5.12 Special Maintenance Practices.....	4-36
	4.5.13 Wildlife Management Practices.....	4-36
	4.5.14 Practices and Procedures to Minimize Adverse Impacts	4-36
	4.5.15 Decommissioning	4-37
	4.5.16 Cumulative Impacts	4-37
	4.5.17 Comparative Ecological Resource Impacts of Alternative Actions.....	4-37
	4.5.17.1 No-Action Alternative.....	4-37
	4.5.17.2 Reasonable Alternatives.....	4-38
4.6	Air Quality Impacts	4-38
	4.6.1 Air Quality Impacts from Construction	4-38
	4.6.2 Air Quality Impacts from Operations	4-41
	4.6.2.1 Description of Gaseous Effluents.....	4-42
	4.6.2.2 Process Off-gas Emission Treatment (Plant KOH Scrubbing	
	System).....	4-43
	4.6.2.3 Calculation of Atmospheric Dispersion and Deposition Factors	4-44
	4.6.3 Decommissioning	4-46
	4.6.4 Visibility Impacts.....	4-46
	4.6.5 Control of Impacts	4-46
	4.6.6 Cumulative Impacts	4-47
	4.6.7 Comparative Air Quality Impacts of No-Action Alternative Scenarios	4-47
	4.6.7.1 No-Action Alternative.....	4-47
	4.6.7.2 Reasonable Alternatives.....	4-47
4.7	Noise Impacts	4-48
	4.7.1 Predicted Noise Levels	4-48

	4.7.1.1	Construction Impacts	4-48
	4.7.1.2	Operational Impacts	4-50
	4.7.1.3	Facility Decommissioning	4-50
	4.7.2	Noise Sources	4-50
	4.7.3	Sound Level Standards	4-50
	4.7.4	Potential Impacts to Sensitive Receptors	4-51
	4.7.4.1	Impacts to the Community	4-51
	4.7.4.2	Impacts to Wildlife.....	4-52
	4.7.5	Cumulative Effects	4-52
	4.7.6	Control of Noise Impacts to Community.....	4-52
	4.7.6.1	Construction Noise Control.....	4-52
	4.7.6.2	Operation Noise Control	4-52
	4.7.7	Comparative Noise Impacts of Alternative Actions	4-53
	4.7.7.1	No-Action Alternative.....	4-53
	4.7.7.2	Reasonable Alternatives.....	4-53
4.8		Historic and Cultural Resource Impacts	4-53
	4.8.1	Proposed Action.....	4-54
	4.8.1.1	Site Preparation and Construction.....	4-54
	4.8.1.2	Operation.....	4-54
	4.8.1.3	Decommissioning.....	4-54
	4.8.2	Agency Consultation.....	4-54
	4.8.3	Historic Preservation.....	4-54
	4.8.4	Potential for Human Remains.....	4-55
	4.8.5	Minimizing Adverse Impacts.....	4-55
	4.8.6	Cumulative Impacts	4-55
	4.8.7	Comparative Historical and Cultural Resource Impacts of Alternative Scenarios.....	4-55
	4.8.7.1	No-Action Alternative.....	4-55
	4.8.7.2	Reasonable Alternatives.....	4-56
4.9		Visual/Scenic Resources Impacts	4-56
	4.9.1	Photos	4-56
	4.9.2	Proposed Action.....	4-56
	4.9.2.1	Site Preparation and Construction.....	4-57
	4.9.2.2	Operation.....	4-57
	4.9.2.3	Decommissioning.....	4-57
	4.9.3	Aesthetic and Scenic Quality Rating	4-57
	4.9.4	Significant Visual Impacts.....	4-58
	4.9.4.1	Physical Facilities Out of Character with Existing Features.....	4-61
	4.9.4.2	Structure Obstructing Existing Views.....	4-61
	4.9.4.3	Structures Creating Visual Intrusions	4-61
	4.9.4.4	Structures Requiring the Removal of Barriers, Screens or Buffers ...	4-62
	4.9.4.5	Altered Historical, Archaeological or Cultural Properties	4-62
	4.9.4.6	Structures that Create Visual, Audible or Atmospheric Elements Out of Character	4-62
	4.9.5	Visual Compatibility and Compliance.....	4-62
	4.9.6	Cumulative Impacts to Visual/Scenic Quality	4-63
	4.9.7	Comparative Visual/Scenic Resources Impacts of No-Action Alternative	4-63
	4.9.7.1	No-Action Alternative.....	4-63
	4.9.7.2	Reasonable Alternatives.....	4-64
4.10		Socioeconomic Impacts	4-64
	4.10.1	Facility Construction.....	4-64

	4.10.1.1 Worker Population	4-64
	4.10.1.2 Impacts of Human Activities	4-65
4.10.2	Facility Operation	4-67
	4.10.2.1 Jobs, Income, and Population.....	4-67
	4.10.2.2 Community Characteristic Impacts.....	4-69
4.10.3	Decommissioning	4-70
	4.10.3.1 Impact of Decommissioning on Population.....	4-70
	4.10.3.2 Economic Impact of Decommissioning	4-70
	4.10.3.3 Impact on Social Services	4-71
4.10.4	Cumulative Socioeconomic Impacts.....	4-71
4.10.5	Comparative Socioeconomic Impacts of No-Action Alternative Scenarios.....	4-71
	4.10.5.1 No-Action Alternative.....	4-72
	4.10.5.2 Reasonable Alternatives.....	4-72
4.11	Environmental Justice.....	4-72
	4.11.1 Procedure and Evaluation Criteria	4-73
	4.11.2 Results of Census Block Group Data.....	4-73
	4.11.3 NRC Review of NEF Environmental Justice.....	4-74
	4.11.4 Proposed Action.....	4-75
	4.11.4.1 Site Preparation and Construction.....	4-75
	4.11.4.2 Operation.....	4-77
	4.11.4.3 Decommissioning.....	4-78
	4.11.4.4 Cumulative Impacts	4-78
4.11.5	Comparative Environmental Justice Impact of Alternative Actions	4-79
	4.11.5.1 No-Action Alternative.....	4-79
	4.11.5.2 Reasonable Alternatives.....	4-79
4.12	Public and Occupational Health Impacts	4-80
	4.12.1 Nonradiological Impacts.....	4-80
	4.12.1.1 Routine Gaseous Effluent	4-80
	4.12.1.2 Routine Liquid Effluent	4-81
4.12.2	Radiological Impacts	4-82
	4.12.2.1 Pathway Assessment	4-83
	4.12.2.2 Public and Occupational Exposure Impacts.....	4-84
4.12.3	Environmental Effects of Accidents	4-89
	4.12.3.1 Description of Postulated Accidents	4-92
	4.12.3.2 Natural Phenomena	4-93
	4.12.3.3 Fires.....	4-93
	4.12.3.4 Process Upsets.....	4-94
4.12.4	Comparative Public and Occupational Exposure Impacts of No-Action Alternative Scenarios	4-94
	4.12.4.1 No-Action Alternative.....	4-94
	4.12.4.2 Reasonable Alternatives.....	4-94
4.13	Waste Management Impacts	4-95
	4.13.1 Waste Descriptions	4-95
	4.13.2 Waste Management System Description	4-95
	4.13.3 Waste Disposal Plans.....	4-96
	4.13.3.1 Radioactive and Mixed Waste Disposal Plans.....	4-96
	4.13.3.2 Liquid Wastes	4-96
4.13.4	Waste Minimization.....	4-96
	4.13.4.1 Control and Conservation	4-97
	4.13.4.2 Reprocessing and Recovery Systems.....	4-98

4.13.5	Comparative Waste Management Impacts of No-Action Alternative	
Scenarios.....		4-99
4.13.5.1	No-Action Alternative.....	4-99
4.13.5.2	Reasonable Alternatives.....	4-99
5.	MITIGATION MEASURES.....	5-1
5.1	Impact Summary.....	5-1
5.1.1	Land Use.....	5-1
5.1.2	Transportation.....	5-2
5.1.3	Geology and Soils.....	5-2
5.1.4	Water Resources	5-3
5.1.5	Ecological Resources.....	5-3
5.1.6	Air Quality.....	5-4
5.1.7	Noise.....	5-4
5.1.8	Historical and Cultural Resources	5-4
5.1.9	Visual/Scenic Resources.....	5-5
5.1.10	Socioeconomic.....	5-5
5.1.11	Environmental Justice.....	5-5
5.1.12	Public and Occupational Health.....	5-5
5.1.12.1	Nonradiological–Normal Operations	5-6
5.1.12.2	Radiological–Normal Operations.....	5-6
5.1.12.3	Environmental Effects of Accidents	5-7
5.1.13	Waste Management.....	5-7
5.2	Mitigations.....	5-7
5.2.1	Land Use.....	5-7
5.2.2	Transportation.....	5-8
5.2.3	Geology and Soils.....	5-9
5.2.4	Water Resources	5-9
5.2.5	Ecological Resources.....	5-11
5.2.6	Air Quality.....	5-11
5.2.7	Noise.....	5-12
5.2.8	Historical and Cultural Resources	5-12
5.2.9	Visual/Scenic Resources.....	5-13
5.2.10	Socioeconomic.....	5-13
5.2.11	Environmental Justice.....	5-13
5.2.12	Public and Occupational Health.....	5-13
5.2.12.1	Nonradiological-Normal Operation	5-14
5.2.12.2	Radiological-Normal Operations	5-14
5.2.12.3	Environmental Effects on Accidents.....	5-16
5.2.13	Waste Management.....	5-16
6	ENVIRONMENTAL MEASUREMENTS AND MONITORING PROGRAMS.....	6-1
6.1	Radiological Monitoring.....	6-1
6.1.1	Effluent Monitoring Program	6-1
6.1.1.1	Gaseous Effluent Monitoring.....	6-4
6.1.1.2	Liquid Effluent Monitoring.....	6-5
6.1.2	Radiological Environmental Monitoring Program	6-5
6.1.2.1	Sampling Program.....	6-5
6.1.2.2	Procedures.....	6-8
6.1.2.3	Reporting.....	6-8
6.2	Physiochemical Monitoring.....	6-9
6.2.1	Introduction.....	6-9
6.2.2	Evaluation and Analysis of Samples.....	6-9

6.2.3	Effluent Monitoring	6-9
6.2.4	Stormwater Monitoring Program	6-10
6.2.5	Environmental Monitoring	6-12
6.2.6	Meteorological Monitoring	6-12
6.2.7	Biota.....	6-13
6.2.8	Quality Assurance.....	6-13
6.2.9	Lower Limits of Detection.....	6-13
6.3	Ecological Monitoring	6-14
6.3.1	Maps	6-14
6.3.1	General Ecological Conditions of the Site.....	6-14
6.3.3	Affected Important Ecological Resources	6-15
6.3.4	Monitoring Program Elements.....	6-16
6.3.5	Observations and Sampling Design	6-17
6.3.5.1	Vegetation	6-18
6.3.5.2	Birds	6-18
6.3.5.3	Mammals.....	6-19
6.3.5.4	Reptilian and Amphibians.....	6-19
6.3.6	Statistical Validity of Sampling Program	6-20
6.3.7	Sampling Equipment.....	6-20
6.3.8	Method of Chemical Analysis	6-20
6.3.9	Data Analysis and Reporting Procedures	6-20
6.3.10	Agency Consultation.....	6-20
6.3.11	Organization Responsible for Reviewing the Monitoring Program on an Ongoing Basis	6-20
6.3.12	Established Criteria.....	6-20
7.	COST-BENEFIT ANALYSIS	7-1
7.1	Proposed Action Economic Cost-Benefits, Facility Construction and Operation	7-1
7.1.1	Introduction.....	7-1
7.1.2	Basis of Construction and Operating Costs-Benefit Estimates for the Proposed Action	7-2
7.1.3	Assumptions in the Cost-Benefit Analysis	7-4
7.1.4	Construction and Pre-Startup Costs	7-5
7.1.4.1	Capital Cost Estimating Methods.....	7-5
7.1.4.2	Capital Cost Estimates for the IIFP Commercial Facility	7-5
7.1.5	Operation Costs	7-8
7.1.5.1	Raw Materials	7-8
7.1.5.2	Utilities.....	7-8
7.1.5.3	Selling and Distribution	7-9
7.1.5.4	Operational and Maintenance Materials	7-10
7.1.5.5	Labor	7-10
7.1.5.6	Waste Disposal.....	7-11
7.1.5.7	Insurance and Taxes.....	7-12
7.1.5.8	Decommissioning Fund	7-13
7.2	Regional Economics	7-14
7.2.1.	Recent Trends in Economic Growth and Employment	7-14
7.2.2	Trends in Income	7-16
7.2.2.1	New Mexico Income/Poverty	7-16
7.2.2.2	Texas Income/Poverty.....	7-18
7.2.2.3	Local Nine-County Income.....	7-18
7.3	No-Action Alternative and Reasonable Alternative Actions.....	7-19
7.4	Summary of Cost-Benefits of the Proposed IIFP Facility	7-20

8	SUMMARY OF ENVIRONMENTAL CONSEQUENCES	8-1
8.1	Unavoidable Adverse Environmental Impacts	8-1
8.2	Irreversible and Irretrievable Commitments of Resources Used In Project Construction and Operation.....	8-1
8.2.1	Irreversible Resource Commitments.....	8-1
8.2.2	Irretrievable Resource Commitments	8-2
8.3	Short-Term and Long-Term Impacts	8-3
8.3.1	Land Use Impacts	8-3
8.3.2	Transportation Impacts	8-4
8.3.3	Geology and Soils Impacts	8-5
8.3.4	Water Resources Impacts.....	8-6
8.3.5	Ecological Resources Impacts	8-7
8.3.6	Air Quality Impacts	8-8
8.3.7	Noise Impacts	8-9
8.3.8	Historic and Cultural Resource Impacts	8-10
8.3.9	Visual/Scenic Resources Impacts	8-11
8.3.10	Socioeconomic Impacts	8-12
8.3.11	Environmental Justice.....	8-13
8.3.12	Public and Occupational Health Impacts	8-13
8.3.13	Waste Management Impacts	8-15
8.4	Relationship Between Short-Term Use of The Environment and The Maintenance and Enhancement of Long-Term Productivity	8-17
8.5	No-Action Alternative	8-19
8.6	Reasonable Alternative Actions.....	8-19
8.7	Conclusion	8-20
9.	LIST OF REFERENCES	9-1
10.	LIST OF PREPARERS	10-1

LIST OF APPENDICES

Appendix A	Glossary	A-1
Appendix B	Consultation Letters	B-1
Appendix C	Environmental Justice	C-1

LIST OF FIGURES

	Page
Figure 1- 1 General Location of the Proposed IIFP 640-Acre Section.....	1-1
Figure 1- 2 Projected IIFP Facility Estimated Annual Capacity.....	1-4
Figure 1- 3 UF ₆ Cylinders Stored at the Paducah Gaseous Diffusion Plant	1-6
Figure 1- 4 IIFP Location in Southeastern New Mexico	1-12
Figure 1- 5 Location of the Proposed IIFP Site	1-13
Figure 1- 6 Easements on IIFP Site	1-30
Figure 2- 1 Location of Proposed IIFP Site	2-2
Figure 2- 2 IIFP Site Map with Surrounding Industrial Properties.....	2-3
Figure 2- 3 Location of the IIFP Facility within Section 27 of the Proposed Site.....	2-3
Figure 2- 4 DUF ₆ to DUF ₄ Plant Major Flows	2-7
Figure 2- 5 SiF ₄ Plant Major Flows	2-8
Figure 2- 6 BF ₃ Plant Major Flows.....	2-10
Figure 2- 7 DUF ₆ to Oxide Plant Major Flows.....	2-11
Figure 2- 8 Plant KOH Process Scrubber System Major Flows	2-12
Figure 2- 9 Environmental Protection Process Major Flows	2-13
Figure 2- 10 IIFP Facility Site Plan	2-20
Figure 2- 11 Solar Ground-mount Grid System.....	2-27
Figure 2- 12 Roof-Solar Units	2-27
Figure 2- 13 Paducah GDP with Thousands of UF ₆ Cylinders Stored in Foreground.....	2-39
Figure 2- 14 UF ₆ Cylinders Stored at the Portsmouth GDP	2-40
Figure 2- 15 Estimated DUF ₆ Generated from New Enrichment Plants in the U.S.....	2-41
Figure 3- 1 Lea County New Mexico	3-1
Figure 3- 2 Land Status for the Area around the Proposed IIFP Site.....	3-2
Figure 3- 3 Topographic Map of the Proposed IIFP Site.....	3-3
Figure 3- 4 Industries Located Around the International Isotopes Site	3-4
Figure 3- 5 Power Plant Located Across Highway NM 483 from IIFP Facility	3-5
Figure 3- 6 Xcel Energy Maddox Station East of the IIFP Facility	3-5
Figure 3- 7 Colorado Energy Station Northeast of the IIFP Facility	3-6
Figure 3- 8 DCP Midstream Linam Ranch Plant Southeast of the IIFP Facility	3-6
Figure 3- 9 New Mexico Active Mines, 2007	3-7
Figure 3- 10 New Mexico Mineral Production Value and Revenue Generated, 1989-2007	3-8
Figure 3- 11 Percentage of Production Value, Employment, Payroll and Revenue by Commodity, 2007	3-9
Figure 3- 12 Transportation Infrastructure for Southeastern New Mexico.....	3-10
Figure 3- 13 Regional Physiography	3-14
Figure 3- 14 Llano Estacado and Vicinity	3-14
Figure 3- 15 Physiography of Southeast New Mexico	3-15
Figure 3- 16 The Mescalero Ridge As It Crosses Lea County at Proposed IIFP Site	3-16
Figure 3- 17 Major Physiographic Features of the Permian Basin Region (With Cross-Section Line to Figure 3-18)	3-17
Figure 3- 18 Major Physiographic Features of the Permian Basin Region (Below Sea Level View)	3-17
Figure 3- 19 Detailed Map Showing Lea County Earthquakes from 1962 to 1998.....	3-19
Figure 3- 20 Seismicity of New Mexico and Bordering Areas.....	3-21
Figure 3- 21 New Mexico Seismic Hazard for a Moment Magnitude (Md) 6 Earthquake	3-22

Figure 3- 22 Detailed Map Showing Lea County Seismic Hazard for a Moment Magnitude (Md) 6 Earthquake	3-22
Figure 3- 23 General Soil Map, Lea County, New Mexico	3-24
Figure 3- 24 Custom Soil Resource Report Soil Map of the IIFP Site	3-26
Figure 3- 25 Typical New Mexico Water Cycle.....	3-28
Figure 3- 26 Ogallala Aquifer.....	3-29
Figure 3- 27 Watercourses, Floodplains, and Playas Map.....	3-29
Figure 3- 28 Water-Level Changes in the Ogallala Aquifer, Predevelopment to 2005	3-40
Figure 3- 29 Present-day Delaware Basin Fluid Flow and Water Chemistry	3-42
Figure 3- 30 Water Wells Located on the Proposed IIFP Site.....	3-43
Figure 3- 31 Topographical Map of Area around IIFP Site at Arkansas Junction.....	3-44
Figure 3- 32 Grasslands of National Forest Systems New Mexico, Oklahoma and Texas	3-45
Figure 3- 33 Hairy Grama Vegetation	3-49
Figure 3- 34 Ring Muhly Grass in Semi Desert Grasslands	3-50
Figure 3- 35 Site Photograph of Ground Cover on IIFP Site.....	3-50
Figure 3- 36 The Lesser Prairie Chicken	3-53
Figure 3- 37 Lesser Prairie Chicken Historic and Current Distribution	3-55
Figure 3- 38 Female Sand Dune Lizard Under Shinnery Oak	3-56
Figure 3- 39 Sand Blowout Surrounded by Shinnery Oak, Exemplifying Optimal Sand Dune Lizard Habitat	3-56
Figure 3- 40 Expected Range of the Sand Dune Lizard.....	3-57
Figure 3- 41 Photograph of the Northern Aplomado Falcon	3-58
Figure 3- 42 Black-Footed Ferret in a Snow Environment.....	3-60
Figure 3- 43 American Peregrine Falcon.....	3-61
Figure 3- 44 Arctic Peregrine Falcon.....	3-62
Figure 3- 45 Baird's Sparrow	3-63
Figure 3- 46 Bell's Vireo	3-65
Figure 3- 47 Burrowing Owl.....	3-66
Figure 3- 48 Yellow-Billed Cuckoo.....	3-67
Figure 3- 49 Black-Tailed Prairie Dogs.....	3-69
Figure 3- 50 Swift Fox.....	3-70
Figure 3- 51 Final Land Cover Map Showing a Subset of Land Cover Classes in the Legend.....	3-74
Figure 3- 52 Extreme and Average Daily Temperatures for the Hobbs Station	3-80
Figure 3- 53 Average Total Monthly Precipitation for the Hobbs Weather Station	3-80
Figure 3- 54 Average Daily Precipitation for the Hobbs, New Mexico Weather Station.....	3-82
Figure 3- 55 Extreme and Average Precipitation Recorded at the Hobbs Weather Station	3-83
Figure 3- 56 Wind Roses for Midland-Odessa, Roswell, Hobbs, and Eunice for 1993	3-85
Figure 3- 57 Wind Rose for Midland-Odessa, 1987-1991.....	3-86
Figure 3- 58 Wind Distribution for Midland-Odessa, 1987-1991 (NCDC, 1998).....	3-87
Figure 3- 59 Distribution of Stability Classes for Midland-Odessa, 1987-1991	3-88
Figure 3- 60 Tornado Probability Map of the United States (all Intensities).....	3-89
Figure 3- 61 Counties Designated Nonattainment for Criteria Air Pollutants.....	3-93
Figure 3- 62 Topographic Map Around the Proposed IIFP Site.....	3-96
Figure 3- 63 Survey Area Conducted at the IIFP Site	3-99
Figure 3- 64 Archeological Sites/Surveys Around the IIFP Site	3-101
Figure 3- 65 San Jose Projectile Point (IO 1)	3-101
Figure 3- 66 Underground Gas Pipeline Going Southeast to Northwest.....	3-103
Figure 3- 67 Mark West Pinnacle 2 Lines Going East and West.....	3-103
Figure 3- 68 Duke Energy Field Services in Approximate Center of Section.....	3-104
Figure 3- 69 Power Tex and PNM Gas Services Facility in Approximate Center of Section	3-104
Figure 3- 70 Buildings within the IIFP Facility.....	3-105

Figure 3- 71 Region of Influence within a 80-km (50-mi) Radius of the IIFP Facility	3-107
Figure 3- 72 Nine-County Area of Influence around the IIFP Site.....	3-108
Figure 3- 73 Percent Change in Lea County Between 1990 and 2000, by Census Tract	3-113
Figure 3- 74 Population Projections by Areas in Lea County Through 2030.....	3-115
Figure 3- 75 Natural Increase in Lea County, by Race/Ethnicity: 1990 to 2005	3-117
Figure 3- 76 Comparison of Annual Growth in Total Employment for Lea County, New Mexico, and the United States.....	3-119
Figure 3- 77 Lea County Total Employment versus Employment in the Mining and Extraction Industries, 1969 to 2004	3-121
Figure 3- 78 Vacant Housing Units in Lea County by Type and Area in Census Year 2000.....	3-129
Figure 3- 79 Population 18 Years and Older with a High School Diploma or Higher	3-131
Figure 3- 80 Ionizing Radiation Exposure of the Population of the United States	3-137
Figure 4- 1 Integrated Facility	4-2
Figure 4- 2 Aerial Photograph of Southeastern New Mexico and West Texas in the Hobbs Area	4-3
Figure 4- 3 Cities and Major Roads around Hobbs New Mexico.....	4-7
Figure 4- 4 Water Wells Located on the Proposed IIFP Site.....	4-28
Figure 4- 5 Sand Dune Lizard Habitat Areas.....	4-35
Figure 4- 6 Percentage of People Highly Annoyed From Environmental Noise.....	4-51
Figure 4- 7 DCP Midstream Pipeline Junction	4-58
Figure 4- 8 Xcel Lines Going Northeast.....	4-58
Figure 4- 9 PMN Gas Services Line Going Northwest and Southwest Looking Southwest	4-59
Figure 4- 10 Caliche Road Looking West Through Approximate Center	4-59
Figure 4- 11 Caliche Pit in Southeast Corner of Section Looking North	4-60
Figure 4- 12 Midstream Fluid Tank at Center of West Side of Section.....	4-60
Figure 4- 13 Pipeline PNM Gas Services Facility in Approximate Center of Section	4-61
Figure 4- 14 Pumpjack in Southeastern New Mexico	4-62
Figure 4- 15 Hobbs NM Population Projections.....	4-65
Figure 4- 16 Job Growth Projections for Hobbs, New Mexico by 2014	4-67
Figure 4- 17 New Mexico Junior College Fall Credit and Workforce Training Enrollment.....	4-68
Figure 4- 18 Ethnic Breakdown for Hobbs, New Mexico	4-74
Figure 4- 19 Lea County Population, Census 2000 by Census Tract	4-77
Figure 4- 20 Sector Compass Rose Diagram around the IIFP Site.....	4-88
Figure 6- 1 Modified Site Features with Sampling Stations and Monitoring Locations.	6-2
Figure 6- 2 Topographical Map of Area around IIFP Site at Arkansas Junction.....	6-14
Figure 6- 3 Grasslands around the IIFP Site	6-15
Figure 6- 4 Lesser Prairie-Chicken Habitat around the IIFP Facility	6-16
Figure 6- 5 Location of Sand Dune Lizard Habitat around IIFP Site	6-17
Figure 7- 1 Nine-County Economic Impact Area around the IIFP Facility	7-2
Figure 7- 2 Change in Ethnicity/Race for Texas.....	7-15
Figure 7- 3 Median Household Income by Race/Ethnicity in Metropolitan and Nonmetropolitan Counties in New Mexico, 2000	7-16
Figure 7- 4 Percent of Households in Poverty by Race/Ethnicity in Metropolitan and Nonmetropolitan Counties in New Mexico, 2000.....	7-17
Figure 7- 5 Percent of Households in Poverty by Household Structure in Metropolitan and Nonmetropolitan Counties in New Mexico, 2000	7-17

LIST OF TABLES

	Page
Table 1- 1 Phase 1 and Phase 2 Facility Inventories.....	1-5
Table 1- 2 Project Major Milestones.....	1-7
Table 1- 3 Abbreviations for Codes and Standards	1-11
Table 1- 4 Required Federal and State Permits.....	1-31
Table 2- 1 Design Efficiencies for Process Vent Off-gas Treatment Equipment	2-17
Table 2- 2 IIFP Plant Major Process Vent Stacks	2-18
Table 2- 3 Major Buildings and Estimated Sizes.....	2-25
Table 2- 4 Evaluation Criteria for Site Selection	2-37
Table 2- 5 DOE Inventory of Depleted UF ₆	2-40
Table 2- 6 Summary of Expected Impacts from Operation of the Paducah and.....	2-44
Table 3- 1 Characteristics of Uranium Cylinders	3-12
Table 3- 2 Seismic Criteria for New Mexico Site.....	3-18
Table 3- 3 Strongest Earthquakes in New Mexico – 1980 through May 1998.....	3-20
Table 3- 4 Summary of Characteristics of the Primary Soils in Southern High Plains Area in Lea County, New Mexico.....	3-25
Table 3- 5 Characterization of Soils in Proposed Site	3-27
Table 3- 6 Ogallala Aquifer – Stored Water in Lea County	3-31
Table 3- 7 Ogallala Aquifer Annual Water Quality Averages for Hobbs and Eunice, New Mexico	3-38
Table 3- 8 Lea County Historical Water Use.....	3-39
Table 3- 9 Flow across the New Mexico-Texas Border	3-42
Table 3- 10 Mammals, Birds, and Amphibians/Reptiles Potentially Inhabiting the Proposed IIFP Site and Vicinity, and Their Habitat or Seasonal Preferences	3-47
Table 3- 11 Listed and Sensitive Species With Species of Concern in Lea County.....	3-52
Table 3- 12 RTE Specie or Specie of Concern in Lea County, New Mexico Land Covers	3-76
Table 3- 13 Weather Stations at Hobbs, New Mexico.....	3-77
Table 3- 14 Summary of Monthly Temperature at Hobbs, New Mexico, from 1914 to 2006	3-78
Table 3- 15 Annual Temperature Summaries for all Hobbs, NM Weather Stations	3-78
Table 3- 16 Monthly Average Number of Days Maximum Temperature Less Than or Equal to 32°F or Greater Than or Equal to 90°F.....	3-79
Table 3- 17 Temperature Extremes at Hobbs, New Mexico.....	3-79
Table 3- 18 Summary of Monthly Precipitation at Hobbs, New Mexico, from 1914 to 2006	3-81
Table 3- 19 Number of Days of Measurable Rainfall in Hobbs, NM.....	3-83
Table 3- 20 Monthly Average Number of Day Rainfall Greater Than or Equal to 0.10 Inches.....	3-84
Table 3- 21 Estimates of the 24-Hour 100-Year Rain Event in Hobbs, New Mexico.....	3-84
Table 3- 22 Weather Stations Located Near the Proposed IIFP Site	3-85
Table 3- 23 Wind Dynamics for Hobbs and Roswell from 1996 to 2006	3-88
Table 3- 24 Average Morning and Afternoon Mixing Heights (Midland-Odessa, Texas).....	3-90
Table 3- 25 Criteria Pollutants.....	3-91
Table 3- 26 EPA National Ambient Air Quality Standards and State of New Mexico Air Quality Standards	3-92
Table 3- 27 Total Annual Emissions of Air Pollutants at Lea County, New Mexico, and Andrews and Gaines Counties, Texas In Comparison with Larger New Mexico/Texas Counties	3-93

Table 3- 28 Density of Annual Emissions at Lea County, New Mexico, and Andrews and Gaines Counties, Texas In Comparison with Larger New Mexico/Texas Counties	3-94
Table 3- 29 Noise Levels of Common Sources	3-95
Table 3- 30 Site Acceptability Noise Standards as Established by U.S. Department of Housing and Urban Development	3-97
Table 3- 31 Federal Highway Administration Noise Abatement Criteria	3-98
Table 3- 32 Isolated Occurrences (UTM NAD 27, Zone 13)	3-100
Table 3- 33 State Population Level Estimates for the Region of Influence	3-111
Table 3- 34 State Annual Population Growth Estimates for the Region of Influence	3-112
Table 3- 35 Population Growth Projections in the Region of Influence	3-112
Table 3- 36 Distribution of Lea County Population Estimates July 1, 2001 to July 1, 2006.....	3-114
Table 3- 37 Lea County's Annual Growth Rate by Area: July 1, 2000 to July 1, 2006	3-115
Table 3- 38 Percentage of Minority and Low-Income Census Block Groups Within 80 Kilometers (50 Miles) of the Proposed IIFP Site	3-118
Table 3- 39 Employment in the Region of Influence for Census Year 2000.....	3-120
Table 3- 40 Unemployment Rate for the Region of Influence (2001-2006).....	3-120
Table 3- 41 Employment in the Various Industries in New Mexico in Year 2000.....	3-122
Table 3- 42 Employment in the Various Industries in Texas in Year 2000.....	3-123
Table 3- 43 Lea County Wage and Salary Employment by Sector, 2001-2006	3-124
Table 3- 44 Income Levels for the Nine-County Region in Census Year 2000	3-125
Table 3- 45 Gross Receipts Tax Distributions for Lea County	3-126
Table 3- 46 Housing in the Region of Influence around the IIFP Site for Census Year 2000.....	3-127
Table 3- 47 Lea County Housing Units by Type Geographical Area for Census Year 2000	3-128
Table 3- 48 Vacant Housing Units in Lea County, by Area in Census Year 2000.....	3-129
Table 3- 49 Education Characteristics in the Region of Influence for Census Year 2000.....	3-130
Table 3- 50 Education Attainment in the Region of Influence for Census Year 2000	3-130
Table 3- 51 Highest Educational Attainment of Population 18 Years and Older in Lea County	3-131
Table 3- 52 Public School Districts in Lea County.....	3-132
Table 3- 53 Typical Average Concentration Ranges of Terrestrial Radionuclides	3-135
Table 3- 54 Nonfatal Occupational Injuries Projected for Construction and Operations of the IIFP Facility.....	3-138
Table 3- 55 Estimated Annual Quantities of Waste Generated at the IIFP Facility	3-140
Table 4- 1 East-West Traffic Volume on U.S. Highways 62/180	4-8
Table 4- 2 North-South Traffic Volumes on Other Highways in the Area of Influence	4-8
Table 4- 3 Workers 16 Years and Over Commuting to Work in Lea County	4-9
Table 4- 4 Annual Incident-Free Transportation Radiological Dose to the Public and Worker.....	4-15
Table 4- 5 Radionuclide Inventory of Uranium Cylinders	4-16
Table 4- 6 Radiological Consequences for the Population from Severe Transportation Accidents Involving Depleted Uranium Hexafluoride ^a	4-16
Table 4- 7 Radiological Consequences for the Maximally Exposed Individual from Severe Transportation Accidents Involving Depleted Uranium Hexafluoride.....	4-17
Table 4- 8 Chemical Consequences for the Population from Severe Transportation Accidents Involving Depleted Uranium Hexafluoride ^a	4-18
Table 4- 9 Chemical Consequences for the Maximally Exposed Individual from Severe Transportation Accidents Involving Depleted Uranium Hexafluoride.....	4-18
Table 4- 10 Lea County Historical Water Use: 1977-1998	4-27
Table 4- 11 Emission Rates during Construction ¹	4-39

Table 4- 12 Predicted Property-Boundary Air Concentrations and Applicable National Ambient Air Quality Standards	4-40
Table 4- 13 Air Emissions during Operation of On-Site Boilers.....	4-41
Table 4- 14 Estimated Air Emissions during Operation of On-Site Generators.....	4-41
Table 4- 15 Annual Emissions at Lea County, New Mexico, and Andrews and Gaines Counties, Texas In Comparison with Larger New Mexico/Texas Counties	4-42
Table 4- 16 Dispersion Coefficients for Gaussian Plume Models	4-44
Table 4- 17 Annual Average Atmospheric Dispersion Coefficients.....	4-45
Table 4- 18 Attenuated Noise Levels (Decibels A-Weighted ^a) Expected for Operation of Construction Equipment	4-48
Table 4- 19 Summary of Capital Cost Estimate for Phase 1 and Phase 2 FEP/DUP Facility	4-66
Table 4- 20 Plant Estimated Labor for Plant Personnel.....	4-68
Table 4- 21 Estimated Economic Benefits to Region (Local and State) Surrounding the IIFP.....	4-71
Table 4- 22 Potential Impacts of the Proposed Action on Minority and Low-Income Populations	4-75
Table 4- 23 Estimated Annual Non-Radiological Gaseous Effluent.	4-81
Table 4- 24 Estimated and Bounding Radiological Releases from the Stacks	4-81
Table 4- 25 Annual and Committed Dose Equivalents for Exposures to the MEI from Gaseous Effluents ..	4-86
Table 4- 26 Annual and Committed Dose Equivalents for Exposures to the Nearest Resident from Gaseous Effluents.....	4-86
Table 4- 27 Estimated Dose Rates for Site Boundary Locations, MEI, and Nearest Resident.....	4-87
Table 4- 28 Collective Dose Equivalents to All Ages Population (Person-Sv) (gas release pathways).....	4-90
Table 4- 29 Collective Dose Equivalents to All Ages Population (Person-rem) (gas release pathways).....	4-91
Table 6- 1 Gaseous Effluent Sampling Program.....	6-4
Table 6- 2 Radiological Sampling and Analysis Program	6-6
Table 6- 3 Physiochemical Sampling.....	6-11
Table 6- 4 Stormwater Monitoring Program.....	6-11
Table 6- 5 Required Minimum Detectable Concentrations for Environmental Sample Analyses.....	6-13
Table 7- 1 Summary of Capital Cost Estimate for Phase 1 IIFP Facility	7-6
Table 7- 2 Summary of Incremental Capital Cost Estimate for Expansion to Phase 2.....	7-6
Table 7- 3 Summary of Capital Cost Estimate for Total IIFP Facility (Phase 1 and 2).....	7-7
Table 7- 4 Estimated Construction Labor Costs	7-7
Table 7- 5 Estimated Replacement Capital.....	7-7
Table 7- 6 Major Raw Materials and Treating Agents	7-8
Table 7- 7 Utility Estimated Rates	7-9
Table 7- 8 Estimated Labor for Phase 1 Facility	7-11
Table 7- 9 Estimated Labor for Total IIFP Facility (Phase 1 and 2).....	7-11
Table 7- 10 Estimated Range of Annual Waste Disposal Costs	7-12
Table 7- 11 Estimated Tax Revenues to State and Local Communities for Total 40-Year Period Expressed in Thousands of Dollars in Year 2009\$)	7-13
Table 7- 12 Nine-County Region Population	7-15
Table 7- 13 Income Levels for the Nine-County Region.....	7-19
Table 7- 14 Socioeconomic Impacts of the No-Action and Reasonable Alternative Scenarios	7-20
Table 7- 15 Estimated Expenditures and Expected Created Jobs	7-21
Table 7- 16 Estimated Economic Benefits to Region (Local and State) Surrounding the IIFP.....	7-21

Table 7- 17 Qualitative Environmental Costs/Benefits During Construction and Operation of the IIFP Facility7-22

Table 8- 1 Estimated Annual Quantities of Waste Generated at the IIFP Facility8-15

EXECUTIVE SUMMARY

International Isotopes Fluorine Products (IIFP), Inc., a wholly owned subsidiary of International Isotopes, Inc. (INIS), is applying for a license from the U.S. Nuclear Regulatory Commission (NRC) to construct and operate a uranium-processing facility (henceforth referred to as the Proposed IIFP Plant (or the Facility)). IIFP is currently requesting an NRC license for a possession limit of 750,000 kilograms of depleted uranium (kg U) during Phase 1. Prior to the Phase 2 expansion, IIFP will prepare and submit an amended license application for the Phase 2 facility, including possession of up to 2,200,000 kilograms of depleted uranium. IIFP also has a written agreement with the State of New Mexico for maximum limits for uranium and chemicals to be stored, handled or processed on the proposed site at any given time. This Environmental Report is being submitted to the NRC by IIFP to comply with the 10 CFR 51, “Environmental Protection Regulations for Domestic Licensing and Related Regulatory Functions,” requirements in support of the licensing of the Proposed IIFP Facility.

Proposed Action

The Proposed Action is the issuance of an NRC license under Title 10 CFR Part 40, “Domestic Licensing of Source Material” for the IIFP plant. The license application and supporting documentation addresses construction and operation of a facility to utilize depleted uranium hexafluoride (DUF_6) to produce high-purity inorganic fluorides, uranium oxides, and anhydrous hydrofluoric acid. There is no known existing or planned private commercial de-conversion facility in the U.S. or in this hemisphere.

International Isotopes Fluorine Products (IIFP), Inc. proposes to build and operate a new uranium processing plant near Hobbs in Lea County, New Mexico (referred to as the Hobbs site) and to provide services to the uranium enrichment industry for de-conversion of depleted uranium hexafluoride (DUF_6) into uranium oxide for long-term stable disposal. The company will also include a commercial plant to produce specialty fluoride gas products for sale. High-purity silicon tetrafluoride (SiF_4) and boron trifluoride (BF_3) will be manufactured in the IIFP facility by utilizing the fluorine derived from the de-conversion of DUF_6 . The fluoride gas products are highly valuable for applications in the electronic, solar panel, and semi-conductor markets. In addition, anhydrous hydrogen fluoride (AHF) is a by-product of the de-conversion process and is sold as an important chemical for various industrial applications.

The plant facility will be constructed in phases based on the projected amounts of DUF_6 generated by U.S. commercial enrichment plants and the available amounts for de-conversion services. It is anticipated that certain early construction activities will be accomplished prior to issuance of a license by NRC. Early construction activities will be preparatory in nature and will not involve any process or safety-related equipment or systems.

The IIFP facility will be constructed in two phases, with Phase 1 completing the DUF_6 to depleted uranium tetrafluoride (DUF_4) process and the DUF_4 to fluorine products processes and the supporting infrastructure of the plant. The Phase 1 plant is scheduled for startup by the end of 2012. IIFP plans to expand the facility de-conversion capacity by completing construction of a Phase 2 plant with a scheduled start by mid-2016. The Phase 2 plant will consist of additional de-conversion capacity using a process for direct conversion of DUF_6 to uranium oxides.

The initial plant (Phase 1) will be built and operated during the early timeframe when new privately owned uranium enrichment facilities and expansions will be coming on-line; with increasingly large amounts of DUF_6 accumulation projected. In performing the de-conversion services, the DUF_6 is converted to DUF_4 . The DUF_4 is then reacted with oxides of silicon or boron to produce high-purity

silicon tetrafluoride (SiF₄) or boron trifluoride (BF₃) gas products, respectively. In both Phase 1 and 2 plants, the DUF₆ ultimately has its fluoride content extracted as a value-added product or by-product, and the depleted stable uranium oxide is sent to licensed disposal facility.

Need for Proposed Action

IIFP proposes to use its patented Fluorine Extraction Process for recovering the fluorine value in the depleted uranium hexafluoride tails. The planned integrated facility utilizes fluorine extracted from the de-converted DUF₆ to produce the high-purity fluoride gas products, while serving the uranium enrichment suppliers/customers in resolving disposition of their depleted uranium tails.

Gaseous uranium hexafluoride (DUF₆) is produced commercially as the feed material for isotopic enrichment of uranium in existing and planned commercial plants. The enriched DUF₆ is processed further into uranium oxide pellets for preparation of fuel rods that are utilized in nuclear reactors for generating electrical power. Uranium hexafluoride is the normal assay feed for all of the existing uranium enrichment commercial plants; gaseous diffusion and centrifuge processes. It will also be the feed material used in the planned laser-based enrichment plant utilizing the SILEX process.

Four new commercial enrichment plants in the U.S. are either in planning or construction phases, and the accumulated amounts of DUF₆ are projected to increasingly grow. IIFP is designing, engineering and licensing the nation's first privately-owned commercial facility for de-conversion of DUF₆ to meet this increasing need.

Comparison of Alternatives

The No-Action Alternative would have no local impact on current land use; transportation; geology and soils; air, water, and ecological resources; historical and cultural resources; visual/scenic resources; noise; environmental justice and waste management. The No-Action Alternative would result in the loss of socioeconomic opportunities for local communities.

If the Department of Energy (DOE) were to process commercial tails materials at their Paducah, KY or Piketon, OH facilities (currently under construction), an expansion would be required for one or both of these facilities for additional throughput with SMALL to MODERATE impacts. If the commercial enrichment companies were to store tails on-site indefinitely, there would be some impacts from having to construct large storage facilities. Eventually, additional SMALL to MODERATE impacts would be incurred when the uranium would need to be de-converted to a more stable form for disposal.

The Proposed Action, in comparison to the No-Action Alternative, would also have SMALL impacts on land use, historical and cultural resources, visual/scenic resources, air and water resources, geology and soils, noise, and environmental justice. Transportation impacts are expected to be MODERATE during the construction period due to increased traffic on New Mexico Highway 483. Otherwise, transportation impacts are expected to be SMALL. Wildlife populations on the proposed site will be altered during construction but will not be destabilized; therefore, direct and indirect impacts during construction to wildlife will be MODERATE. Overall impacts to wildlife and biotic communities from the construction, operations, and decommissioning of the proposed IIFP facility will be SMALL.

Reasonable Alternatives were considered in comparison to the Proposed Action. One Reasonable Alternative considered includes other commercial enrichment plants constructing their own de-conversion facilities using their own technologies with impacts expected to be SMALL to MODERATE, depending upon the site-specific conditions. If those companies build new facilities to de-convert "tails" material, it

is expected that the land use impacts for this Reasonable Alternative are greater than the Proposed Action, if aqueous HF generated by the Reasonable Alternative is not marketable or sold. This potentially greater impact is due to the difference in the Reasonable Alternative technology that produces aqueous HF and in the treatment and generation of CaF₂ waste if it cannot be sold.

Another Reasonable Alternative is that two of the enrichment companies have de-conversion facilities overseas, and they could choose to ship their DUF₆ from the U.S. to their facilities for de-conversion. This alternative would require the other two enrichment companies in the U.S. to rely upon the No-Action Alternative or the Reasonable Alternatives stated in previous paragraphs.

Those companies that have existing overseas facilities and technologies would be required to ship DUF₆ overseas long-distances and may have to return the waste oxides to the United States for licensed disposal or may have to arrange with other countries for disposal. It is expected that transportation impacts for this option of shipping the DUF₆ overseas may be greater than the Proposed Action. If those companies were to use their own technologies, it is expected that the aqueous HF, if not sold, would result in larger impacts than the Proposed Action.

Conclusion

The Proposed Action is to construct and operate a facility at Hobbs, New Mexico. Short-term impacts of the proposed IIFP facility on the public and the environment would be controlled and minimized to the extent practical with the implementation of mitigation measures and good resource management practices as described in Chapter 5. Considering both private and public benefits and costs, the proposed IIFP facility would result in socioeconomic net benefits in the affected communities. The construction, operation, and decommissioning of the proposed IIFP facility at the Hobbs, New Mexico site would require short-term uses of environmental resources that would have an overall SMALL adverse impact on the environment and the quality of life for the public.

ACRONYMS and ABBREVIATIONS

AC	alternating current
ACI	American Concrete Institute
AEA	<i>Atomic Energy Act</i>
AEP	American Electric Power
AEGL	Acute Exposure Guideline Level
AISC	American Institute of Steel Construction
ALARA	as low as reasonably achievable
ALI	Annual Limit on Intake
amsl	above mean sea level
ANPR	Advance Notice of Proposed Rulemaking
ANS	American Nuclear Society
ANSI	American National Standards Institute
AP	air particulate
APE	area of potential effects
AQB	Air Quality Bureau
ASCE	American Society of Civil Engineers
ASLB	Atomic Safety and Licensing Board
ASME	American Society of Mechanical Engineers
ASNT	American Society of Nondestructive Testing
ASTM	American Society for Testing Materials
ATSDR	Agency for Toxic Substances and Disease Registry
BDC	baseline design criteria
BEA	Bureau of Economic Analysis
bgs	below ground surface
BLM	Bureau of Land Management
BLS	Bureau of Labor Statistics
BMP	Best Management Practices
BOD	biochemical oxygen demand
BS	Bachelor of Science
CA	Controlled Area
CAA	<i>Clean Air Act</i>
CAAS	Criticality Accident Alarm System
CAM	Continuous Air Monitor
CAP	Corrective Action Program
CBG	Census Block Group
CCZ	Contamination Control Zone
CEDE	Committed Effective Dose Equivalent
CEQ	Council on Environmental Quality
CERCLA	<i>Comprehensive Environmental Response, Compensation, and Liability Act</i>
CFO	Chief Financial Officer
CFR	Code of Federal Regulations
CHP	certified health physicist
CM	configuration management
COD	chemical oxygen demand
COO	Chief Operating Officer
CWA	<i>Clean Water Act</i>

D&D	decontamination and decommissioning
DAC	derived air concentration
DBA	design basis accident
DBE	design basis earthquake
DCF	dose conversion factor
DE	Dose Equivalent
DEIS	Draft Environmental Impact Statement
DOA	U.S. Department of Agriculture
DOC	United States Department of Commerce
DOE	United States Department of Energy
DOI	United States Department of Interior
DOT	United States Department of Transportation
E	east
EDE	Effective Dose Equivalent
EIA	Energy Information Administration
EIS	Environmental Impact Statement
EJ	Environmental Justice
EMS	Emergency Medical Services
EOC	Emergency Operations Center
EPA	United States Environmental Protection Agency
EPCRA	<i>Emergency Planning and Community Right-to-Know Act</i>
eqs.	equations
ER	Environmental Report
ERPG	Emergency Response Planning Guideline
ENE	east north east
ESE	east south east
FEIS	Final Environmental Impact Statement
FEMA	Federal Emergency Management Agency
FHA	fire hazards analysis
FR	Federal Register
FTE	full-time equivalents
FWPCA	<i>Federal Water Pollution Control Act</i>
GDP	Gaseous Diffusion Plant
GET	General Employee Training
GPS	Global Positioning System
HEPA	high efficiency particulate air
HMTA	<i>Hazardous Materials Transportation Act</i>
HS&E	Health, Safety, and Environment
HUD	United States Department of Housing and Urban Development
HVAC	heating, ventilating, and air conditioning
HWA	<i>Hazardous Waste Act</i>
HWB	Hazardous Waste Bureau
IAEA	International Atomic Energy Agency
ICRP	International Commission on Radiological Protection
I/O or I-O	input/output
IROFS	items relied on for safety

ISA	Integrated Safety Analysis
ISO	International Organization for Standardization
LAN	local area network
Ldn	Day-Night Average Sound Level
Leq	Equivalent Sound Level
LES	Louisiana Energy Services
LEU	low enriched uranium
LLC	Limited Liability Company
LLD	lower limits of detection
LLW	low-level waste
LTA	lost time accident
M&TE	measuring and test equipment
MAPEP	Mixed Analyte Performance Evaluation Program
max.	maximum
MC&A	material control and accountability
MCL	maximum contaminant level
MCNP	Monte Carlo N-Particle
MDA	minimum detectable activity
MDC	minimum detectable concentration
MEI	maximally exposed individual
ME&I	mechanical, electrical and instrumentation
min.	minimum
MM	modified mercalli
MMI	modified mercalli intensity
MOU	Memorandum of Understanding
N	north
NAAQS	National Ambient Air Quality Standards
NASA	National Aeronautic Space Administration
NCA	<i>Noise Control Act</i>
NCRP	National Council on Radiological Protection and Measurements
NCS	nuclear criticality safety
NCSE	nuclear criticality safety evaluation
NDA	Non-destructive assessment
NE	northeast
NEF	National Enrichment Facility
NEI	Nuclear Energy Institute
NEPA	<i>National Environmental Policy Act</i>
NESHAPS	National Emission Standards for Hazardous Air Pollutants
NFPA	National Fire Protection Association
NHPA	<i>National Historic Preservation Act</i>
NELAC	National Environmental Laboratory Accreditation Conference
NFPA	National Fire Protection Association
NIOSH	National Institute of Occupational Safety and Health
NIST	National Institute of Standards and Technology
NM	New Mexico
NMAC	New Mexico Administrative Code
NMDGF	New Mexico Department of Game and Fish
NMED	New Mexico Environmental Department

NMHWB	New Mexico Hazardous Waste Bureau
NMRPR	New Mexico Radiation Protection Regulations
NMSE	New Mexico State Engineer
NMSHPO	New Mexico State Historic Preservation Office
NMSLO	New Mexico State Land Office
NMWQB	New Mexico Water Quality Bureau
NMWQCC	New Mexico Quality Control Commission
NNE	north-northeast
NNW	north-northwest
No.	number
NOAA	National Oceanic and Atmospheric Administration
NOI	Notice of Intent
NPDES	National Pollutant Discharge Elimination System
NPDWS	National Primary Drinking Water Standard
NRC	United States Nuclear Regulatory Commission
NRHP	National Register of Historic Places
NSDWS	National Secondary Drinking Water Standard
NTS	Nevada Test Site
NWS	National Weather Service
NW	northwest
ORNL	Oak Ridge National Laboratory
OSHA	Occupational Safety and Health Administration
P&IDs	pipng and instrumentation diagrams
p.	page
PEL	Permissible Exposure Level
PGA	peak ground acceleration
PGDP	Paducah Gaseous Diffusion Plant
pH	measure of the acidity or alkalinity
PHA	Process Hazard Analysis
PIA	Potentially Impacted Area
PLC	Programmable Logic Controllers
PM	preventive maintenance
PM _{2.5}	particulates < 2.5 μ m
PM ₁₀	particulates < 10 μ m
PORTS	Portsmouth Gaseous Diffusion Plant
POTW	Publicly Owned Treatment Works
pp.	pages
PSAR	Preliminary Safety Analysis Report
QA	quality assurance
QAPD	Quality Assurance Program Description
QC	quality control
RCB	Radiation Control Bureau
RCRA	<i>Resource Conservation and Recovery Act</i>
RCZ	radiation control zone
REIS	Regional Economic Information System
REMP	Radiological Environmental Monitoring Program
RIMS	Regional Input-Output Modeling System

ROI	Region of Interest or Radius of Influence
RTE	Rare Threatened and Endangered
RWP	radiation work permit
S	
SAR	Safety Analysis Report
SDWA	<i>Safe Drinking Water Act</i>
SE	southeast
SER	Safety Evaluation Report
SHPO	State Historic Preservation Officer
SPCC	spill prevention, control, and countermeasures
SPL	Sound Level Pressure
SSC	structure, system, and component
SSE	south-southeast
SSW	south-southwest
STEL	short term exposure limits
STP	standard temperature and pressure
SVOC	semivolatile organic compounds
SW	southwest
SWPPP	Storm Water Pollution Prevention Plan
TDS	
TEDE	total effective dose equivalent
TLD	thermoluminescent dosimeter
TSCA	<i>Toxic Substances Control Act</i> of 1976
TSP	total suspended particulates
TWA	time weighted average
TWDB	Texas Water Development Board
TX	Texas
UDS	
UNSCEAR	United Nations Scientific Committee on the Effects of Atomic Radiation
UPS	uninterruptible power supply
U.S.	United States
USACE	United States Army Corps of Engineers
USEC	United States Enrichment Corporation, Inc.
USDA	United States Department of Agriculture
USFWS	United States Fish and Wildlife Service
USGS	United States Geological Survey
UST	underground storage tank
UV	ultraviolet
VOC	
VOC	volatile organic compound
W	
WAC	waste acceptance criteria
WCS	Waste Control Specialists
WIPP	Waste Isolation Pilot Plant
WMA	wildlife management area
WNW	west-northwest
WSW	west-southwest

1. INTRODUCTION

This Environmental Report (ER) constitutes one portion of an application being submitted by International Isotopes Fluorine Products (IIFP) to construct and operate a facility that will utilize depleted uranium hexafluoride (DUF_6) to produce high purity inorganic fluorides, uranium oxides, and anhydrous hydrofluoric acid (AHF). The proposed IIFP facility will be located near Hobbs, New Mexico (Figure 1-1). The ER for this proposed facility serves two primary purposes. First, it provides information that is specifically required by the NRC to assist it in meeting its obligations under the *National Environmental Policy Act (NEPA) of 1969* (USC, 2009a) and the agency’s NEPA-implementing regulations. Second, it demonstrates that the environmental protection measures proposed by IIFP are adequate to protect both the environment and the health and safety of the public.

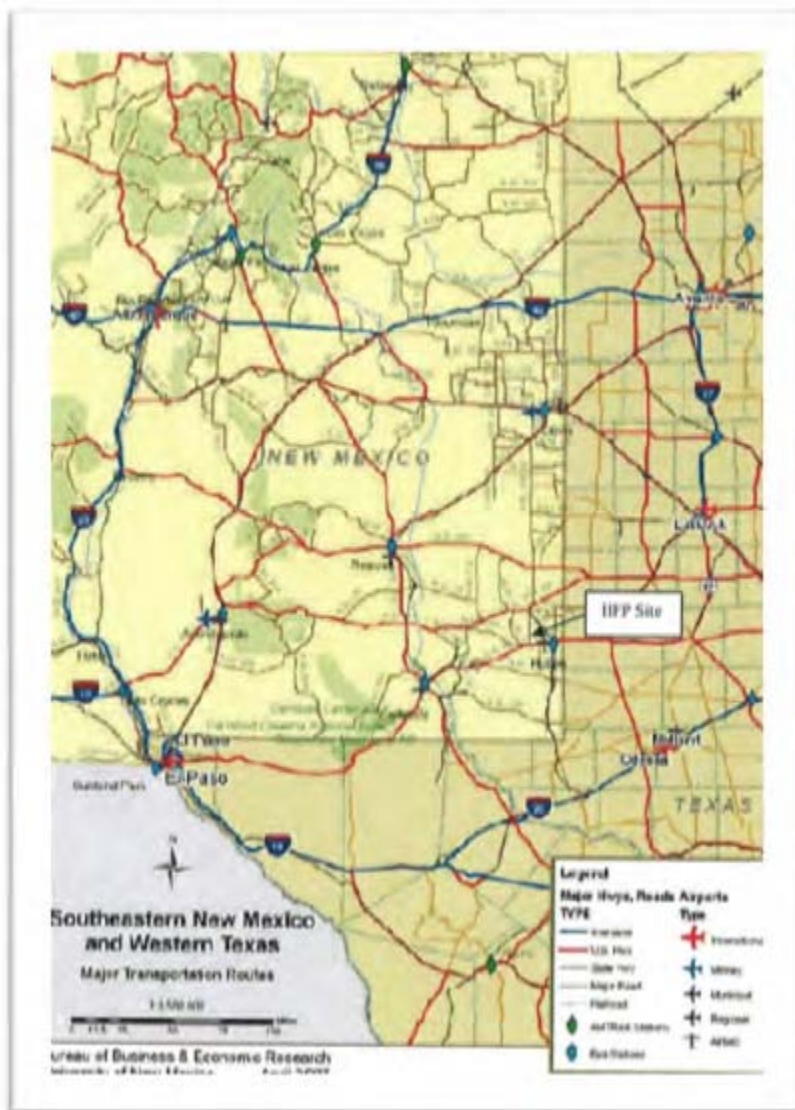

Figure 1- 1 General Location of the Proposed IIFP 640-Acre Section

IIFP has prepared this ER to meet the requirements specified in 10 CFR 51, Subpart A, particularly those requirements set forth in 10 CFR 51.45(b)-(e). The organization of this ER is generally consistent with

NUREG-1748, “Environmental Review Guidance for Licensing Actions Associated with NMSS Programs, Final Report” (NRC, 2003a).

This ER evaluates the environmental impacts of the proposed IIFP facility. Accordingly, this document discusses the Proposed Action, the need for and purposes of the Proposed Action, applicable regulatory requirements, impacts, consequences, etc. as included in the following chapters:

- Chapter 1, “Introduction of the Environmental Report,” identifies briefly the general Proposed Action, the affected region and site area, the Proposed Action schedule for implementation and the applicable regulations with the current status.
- Chapter 2, “Alternatives,” describes in more detail the Proposed Action, process descriptions and considers the Reasonable Alternatives, if any, to the Proposed Action.
- Chapter 3, “Description of the Affected Environment,” describes the proposed IIFP facility and the environment potentially affected by the Proposed Action.
- Chapter 4, “Environmental Impacts,” presents and compares the potential impacts resulting from the Proposed Action and its alternatives.
- Chapter 5, “Mitigation Measures,” identifies mitigation measures that could eliminate or lessen the potential environmental impacts of the Proposed Action.
- Chapter 6, “Environmental Measurements and Monitoring Programs,” describes environmental measurements and monitoring programs.
- Chapter 7, “Cost-Benefit Analysis,” provides a cost benefit analysis.
- Chapter 8, “Summary of Environmental Consequences,” summarizes those environmental consequences of the Proposed Action.
- Chapter 9 provides a list of references.
- Chapter 10 provides a list of preparers.

1.1 General Description of the IIFP Facility and Proposed Action

International Isotopes Fluorine Products (IIFP), Inc., a wholly owned subsidiary of International Isotopes, Inc. (INIS), will build and operate a new uranium processing facility (plant) near Hobbs in Lea County, New Mexico. The IIFP Fluorine Extraction Process and Depleted Uranium De-conversion Plant (FEP/DUP) will provide services to the uranium enrichment industry for converting (de-conversion) depleted uranium hexafluoride (DUF_6) into uranium oxide for long-term stable disposal.

The IIFP facility will also include a commercial plant to produce specialty fluoride gas products for sale. High-purity silicon tetrafluoride (SiF_4) and boron trifluoride (BF_3) will be manufactured at the IIFP facility by utilizing the fluorine derived from the de-conversion of DUF_6 . The fluoride gas products are highly valuable for applications in the electronic, solar panel, and semi-conductor markets. In addition, anhydrous hydrogen fluoride (AHF) is a product of the de-conversion and is sold as a chemical in demand for various important industrial applications.

Depleted uranium hexafluoride referred to as “tails” is the by-product of uranium enrichment. Enrichment is required as a vital step in the nuclear fuel cycle to produce fuel for nuclear reactors. All of the existing and planned commercial uranium enrichment processes use uranium hexafluoride (UF_6) as the process feed gas to produce isotopic enriched UF_6 . Upon further processing, the enriched uranium material results in the desired nuclear fuel product. The depleted tails may have some residual value but will ultimately require disposal. A commercial service is needed in the U.S. to convert the DUF_6 into the more stable uranium oxide for long term disposal. This process is generally referred to as “de-conversion”. IIFP is

proposing to design, engineer and license the nation's first privately-owned commercial facility for de-conversion of DUF_6 .

DUF_6 continually will be generated at existing and planned commercial uranium enrichment plants. Additional commercial uranium enrichment plants currently being built or planned in the U.S. will result in generation of increasingly large volumes of DUF_6 . One new commercial uranium enrichment plant is built and scheduled to start up within the next year. One other is licensed and under construction, and two others are in the engineering and licensing review stages. Large amounts of DUF_6 tails material from those facilities will ultimately need de-conversion for stable disposal. The IIFP proposed action will serve much of that need by providing the commercial de-conversion capability at the IIFP facility near Hobbs, NM

The IIFP initial Phase 1 plant, scheduled for operation by end of 2012 consists of two main chemical processes that, when integrated, will comprise the Fluorine Extraction Process and Depleted Uranium De-conversion Plant (FEP/DUP). In performing the de-conversion services, IIFP utilizes the fluoride extracted from the DUF_6 de-conversion to manufacture high-purity silicon tetrafluoride (SiF_4) and boron trifluoride (BF_3). These fluoride gas products are valuable materials for applications in the solar, semiconductor, and electronics industries. In addition, anhydrous hydrogen fluoride (AHF) is a by-product of the de-conversion process and is sold as a high demand chemical for various industrial applications.

In the Phase 1 processes, the DUF_6 is received from the toll service de-conversion customer, vaporized in containment-type autoclaves and fed to a reaction vessel where the DUF_6 reacts with gaseous hydrogen to produce DUF_4 and anhydrous hydrofluoric acid (AHF). The DUF_4 is withdrawn from the reaction vessel as a powdered solid and transferred to the FEP building. The AHF is condensed, packaged into approved tank trailers; the product sold and shipped to customers for use in industrial chemical applications. In the FEP process, the DUF_4 derived from the de-conversion process is mixed with either silicon dioxide (SiO_2) or boron oxide (B_2O_3) and the mix is heated in a rotary calciner to effect the reaction for producing the SiF_4 and BF_3 , respectively. The product off-gas (either SiF_4 or BF_3) passes through pre-condensers to remove trace impurities mainly hydrogen fluoride. The purified product is collected in a cold trap system operating at cryogenic temperature, then evaporated and compressed into storage containers where it is later packaged into customer or transporter-owned containers for shipment to the customer. Final off-gases, consisting primarily of nitrogen, air, hydrofluoric acid (HF) and trace quantities of fluoride are treated in a 3-stage scrubbing system, before being venting to the atmosphere. Process liquors from the scrubber system are treated to regenerate and recycle the scrubber treating agent for reuse in the 3-stage scrubbing system. Uranium oxide from the second-stage reaction vessel is packaged and shipped to an off-site licensed disposal facility.

The future Phase 2 facility will be an expansion of the Phase 1 facility, which provides additional de-conversion capability using a chemical process for direct de-conversion of DUF_6 to uranium oxide. The Phase 2 plant is scheduled to be built and operational by mid- 2016. In the Phase 2 process, DUF_6 is received from the toll-service de-conversion customer, vaporized in containment-type autoclaves and fed to a first-stage reaction vessel where the DUF_6 reacts with a steam-HF vapor mix to produce depleted uranyl oxyfluoride (DUO_2F_2) and concentrated HF vapor. The DUO_2F_2 is withdrawn as a powder and fed to a second-stage reaction vessel and heated with steam to form uranium oxide powder and HF vapor. The HF vapors from both of the reaction vessel stages are condensed and fed to a fractional distillation column where AHF is withdrawn from the top of the column and aqueous HF is taken from the bottom and recycled as feed reactant to the first-stage reaction vessel. The AHF is packaged into approved tank trailers; the product is sold and shipped to customers for use in industrial chemical applications. Uranium

oxide from the second-stage reaction vessel is packaged and shipped to an off-site licensed disposal facility.

Construction of the Phase 1 plant is expected to begin in late 2011 and start up in the late 2012. The expansion construction for a Phase 2 plant is expected to begin in 2015 and operations start up in late 2016. At the end of its useful life, the plant would be decommissioned consistent with the decommissioning plan that is developed and submitted in the IIFP License Application, Chapter 10, “Decommissioning”.

IIFP is designing the company’s Phase 1 plant annual capacity for de-converting approximately 300 DUF₆ cylinders per year; equivalent to about 7.3 million pounds of DUF₆ per year (lb/yr) or 3.3 million kilograms per year (kg/yr). The Phase 1 plant also has a designed production capacity of approximately 2 million lb/yr (0.9 million kg/yr) of specialty fluoride products, and 1 million lb/yr (0.45 million kg/yr) AHF.

Upon completion of Phase 2, the integrated facility will have an overall total de-conversion capacity of nearly 800 DUF₆ cylinders; about 21.7 million lb/yr (9.8 million kg/yr) DUF₆. Nearly 5.7 million lb/yr (2.6 million kg/yr) of AHF product is projected to be produced and sold. A schematic of the process flows and designed operational capacity for the plant is presented as Figure 1-2. A more detailed description of the IIFP Facility processes and the Facility site plan illustrating buildings and layout are provided in Chapter 2 of the ER.

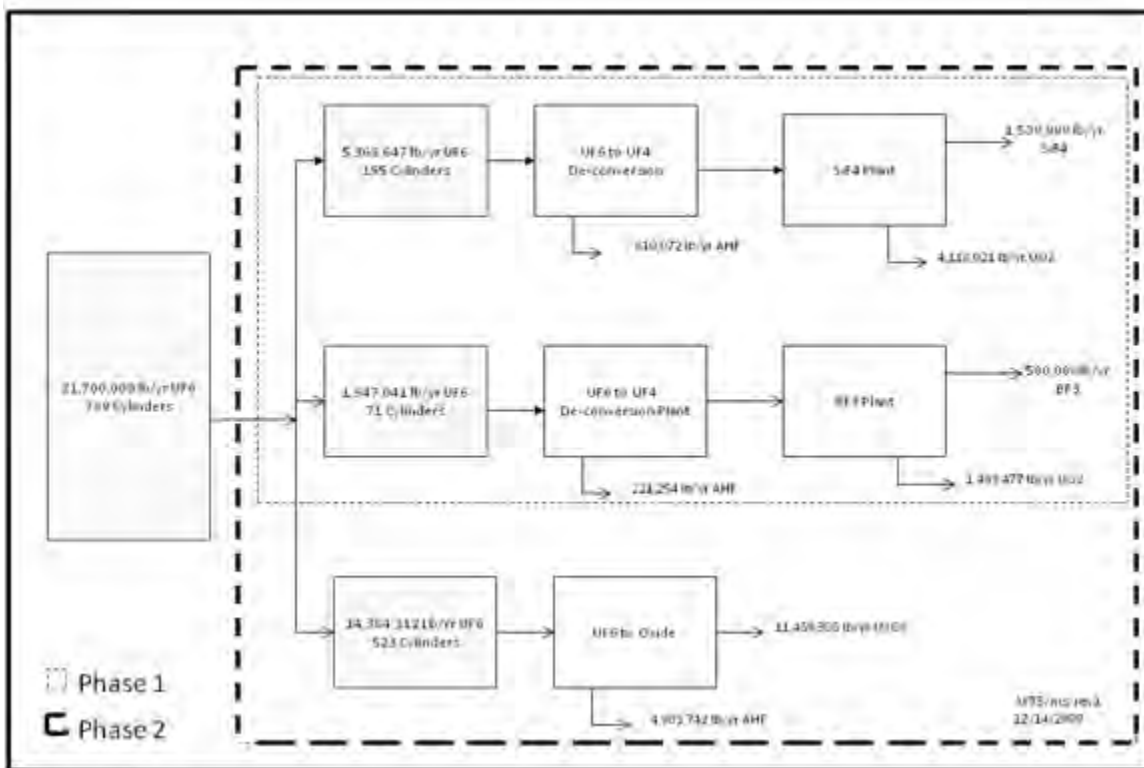

All uranium in the above flowchart is “depleted”.

Figure 1- 2 Projected IIFP Facility Estimated Annual Capacity

1.2 Purpose and Need for Proposed Action

The Proposed Action is the issuance of an NRC license under Title 10 Code of Federal Regulations Part 40, “Domestic Licensing of Source Material” for the IIFP plant. The license application and supporting documentation addresses pre-license construction, construction after license approval and operation of a facility to utilize depleted uranium hexafluoride (DUF₆) to produce high-purity inorganic fluorides, uranium oxides, and anhydrous hydrofluoric acid. There is no known existing or planned private commercial de-conversion capacity in the U.S. or in this hemisphere. This ER is prepared and submitted for both the Phase 1 and Phase 2 facilities.

IIFP is currently requesting an NRC license for a possession limit of 750,000 kilograms of depleted uranium (kg U) during Phase 1. Prior to the Phase 2 expansion, IIFP will prepare and submit an amended license application for the Phase 2 facility, including a possession of up to 2,200,000 kilograms of depleted uranium. The environmental impact evaluation conducted by this ER has been prepared for the Phase 1 and Phase 2 integrated facility. The average projected on-site inventories of uranium materials and major chemicals for both phases of the facility are presented in Table 1-1. IIFP has a written

Table 1- 1 Phase 1 and Phase 2 Facility Inventories

Material	Maximum Limit Agreement with New Mexico ¹	Projected Average Phase 1	Projected Average Phase 2
Total Depleted Uranium (DUF ₆ , DUO ₂ and DUF ₄) ²	4,851,000 lbs (2,200,000 kg)	See Note ²	See Note ²
DUF ₆	See Note ²	15-20 full cylinders	25-50 full cylinders
DUF ₆ in Process	See Note ²	43,000-66,000 lbs (19,500-30,000 kg)	82,000-130,000 lbs (37,300-59,000 kg)
DUF ₄	See Note ²	140,000-300,000 lbs (63,600-136,400 kg)	140,000-300,000 lbs (63,600-136,400 kg)
Uranium Oxides as DUO ₂	See Note ²	340,000-470,000 lbs (154,500-213,600 kg)	600,000-990,000 lbs (272,000-450,000 kg)
HF (aqueous)	51,400 lbs (23,300 kg)	10,000-15,000 lbs (4,500-6,800 kg)	40,000-48,000 lbs (18,200-21,800kg)
AHF	99,200 lbs (45,000 kg)	31,000-35,000 lbs (14,000-15,900 kg)	40,000-50,000 lbs (18,200-22,700 kg)
SiF ₄ (Packaged + in process)	142,700 lbs (64,700 kg)	48,000-70,000 lbs (21,800-31,800 kg)	48,000-70,000 lbs (21,800-31,800 kg)
BF ₃ (Packaged + in process)	49,400 lb (22,400 kg)	17,000-33,000 lbs (7,800-15,000 kg)	17,000-33,000 lbs (7,800-15,000 kg)
KOH	17,900 lbs (8,100 kg)	15,000-17,000 lbs (6,800-7,700 kg)	15,000-17,000 lbs (6,800-7,700 kg)
CaF ₂	80,500 lbs (36,500 kg)	45,000-50,000 lbs (20,400-22,700 kg)	45,000-50,000 lbs (20,400-22,700 kg)

¹ IIFP Integrated Plant Maximum Inventories submitted to the State of Mexico per Agreement.

² Projected Averages: see individual breakdowns for DUF₆ in cylinders and in process; DUF₄ and DUO₂. Maximum limits Total Depleted Uranium includes limits for DUF₆ in cylinders and in process; DUF₄ and DUO₂.

agreement with the New Mexico Environment Department (NMED) on maximum limits of total uranium and chemical inventories.

1.2.1 Need for Proposed Action

De-conversion of DUF_6 , on a plant scale, is being performed in Europe; however, there is no commercial de-conversion capability at present in the United States. The U.S. Department of Energy (DOE) is building two facilities for depleted uranium de-conversion, one in Paducah, Kentucky and the other in Piketon, Ohio. Those DOE facilities are intended to process the tens of thousands of depleted uranium hexafluoride cylinder inventory backlog that DOE already has waiting to be processed (See Figure 1-3, “ UF_6 Cylinders Stored at the Paducah Gaseous Diffusion Plant.”) By most accounts the processing of existing DOE inventory may require from 20 to 25 years, potentially leaving the private commercial sector without a commercial alternative for de-conversion services for a long time. Additional details are provided in Section 2.1 “Detailed Description of Alternatives.”



Figure 1- 3 UF_6 Cylinders Stored at the Paducah Gaseous Diffusion Plant

1.2.2 Applicant for the Proposed Action

The name and address of the responsible official is as follows:

International Isotopes, Inc.
Steve Laflin
President and Chief Executive Officer (CEO)
4137 Commerce Circle
Idaho Falls, Idaho 83401

The President and CEO of International Isotopes is Steve Laflin, a citizen of the United States of America. International Isotope’s principal location for business is Idaho Falls, Idaho. The proposed IIFP

facility will be located in Lea County, near Hobbs, New Mexico. No other companies will be present or operating on the IIFP owner-controlled property other than services specifically contracted by IIFP.

IIFP is responsible for the design, quality assurance, construction, operation, and decommissioning of the FEP/DUP facility. The President reports to the International Isotopes Board of Directors.

1.2.3 Projected Construction and Operational Startup Schedules

Construction of the Phase 1 plant is expected to begin in late 2011 and start up of operations in the late 2012. IIFP intends to request an exemption for some pre-license construction that could start by early 2011. In this ER, pre-license construction is considered in evaluating the environmental impacts. It is anticipated that approval for pre-license construction will be obtained and that some selective construction activities will be accomplished prior to issuance of a license by NRC. These pre-license construction activities will be preparatory in nature and will not involve any process or safety related equipment or systems.

Construction of the Phase 2 plant is expected to begin in early 2015 and start up of operations is project to begin in mid-year 2016. At the end of its useful life, the plant will be decommissioned consistent with the decommissioning plan that is developed and being submitted in the IIFP license application.

Costs for Capital investment, construction, operation and decommissioning are discussed in this ER Chapter 7.

Major milestones are shown in Table 1-2.

Table 1- 2 Project Major Milestones

Milestones	Projected Date
Submit Licensing Application to NRC for Phase 1 Facility	End of 2009
Environmental Report to NRC for Phases 1 and 2	End of 2009
Complete Engineering for Phase 1	3 rd Quarter 2011
Start Pre-Licensing Construction	Early 2011
Obtain NRC License for Phase 1	3 rd Quarter 2011
Initiate Phase 1 Facility Construction	3 rd Quarter 2011
Complete Construction of Phase 1 Facility	3 rd Quarter 2012
Start up Phase 1 Facility	4 th Quarter 2012
Submit Phase 2 amended License Application	2 nd Quarter 2013
Complete Phase 2 Engineering and Initiate Phase 2 Facility Construction	1 st Quarter 2015
Complete Construction of Phase 2 Facility	1 st Quarter 2016
Startup Phase 2 Plant	2 nd Quarter 2016

1.3 Basis of the IIFP Facility Design and Technology

1.3.1 Background

IIFP has acquired patents and developed technology for producing high-purity fluoride products utilizing the otherwise waste fluorine contained in depleted uranium tails. The company built and operated a

relatively small-scale germanium tetrafluoride (GeF_4) testing and production facility in Idaho using FEP technology. As part of its patent acquisitions, IIFP obtained substantial technical information, data and results from larger-scale pilot plant operations of the former patent-owners. IIFP plans to make the new FEP/DUP facility into a larger plant for manufacturing silicon tetrafluoride (SiF_4) and boron trifluoride (BF_3), both of which are in demand commercially.

DUF_4 is the major raw material in supplying the fluorine for production of high-purity fluoride products when using the FEP technology. The DUF_4 obtained from de-conversion of DUF_6 results in the by-product AHF, which is a very marketable. The company has been using DUF_4 obtained from DOE residual inventories in its production of GeF_4 . Additional stock of DOE DUF_4 is available during the near term for conducting pilot demonstrations of other FEP product options or for initial startup. The availability of those inventories, however, is limited both in volume and in the time frame that DOE seems willing to make the material available. There are not sufficient existing inventories of DOE DUF_4 to meet IIFP requirements for FEP product demand; therefore IIFP is building the DUF_6 to DUF_4 process as part of the Phase 1 facility. Likewise, the projected demand for de-conversion services is expected to exceed the demand for fluorine products. IIFP is proposing to build the Phase 2 plant for direct de-conversion of DUF_6 to uranium oxide to meet the projected growing need for de-conversion services for the uranium enrichment industries.

1.3.2 Facility Environmental Design Philosophy

The IIFP commercial plant conceptual design is based on: 1) applied chemistry, 2) pilot plant studies by IIFP and others, and 3) experiences in commercial operations of related uranium and fluorine industrial technologies. The concept considers and includes feasible engineering applications relative to environmental, radiological protection and safety found in similar facilities. The basis for selecting and developing the plant design concept is supported by:

- Uranium hexafluoride technology for UF_4 production is straight-forward. It has a proven track record on a plant scale with many years of operating experience at several facility locations.
- The IIFP GeF_4 process has been operated and is a general demonstration of the FEP process. That operational data and experience are available and useful in designing and operating a similar SiF_4 and BF_3 process plants.
- IIFP acquired the FEP patented technology from a prior owner who conducted relatively pilot-scale demonstration tests for SiF_4 . This pilot testing provided “proof-in-principle” for the chemistry, reaction kinetics, product purity, certain operating parameters and continuous unit operations.
- Reactions of UF_6 with steam and water to produce uranium oxide are well known and demonstrated on a commercial scale.
- Pyrohydrolysis of UO_2F_2 (an intermediate compound of the steam- UF_6 reaction in the direct oxide process) is proven on a commercial scale (Morel, 2008).
- Distillation in HF production plants is operated on an industrial scale by others for commercial sale of AHF. It follows the general principles of distillation process engineering.
- Many of the filters, scrubbers and other release prevention measures are proven designs based on existing technologies and experience already in place in the chemical, gas and AHF industry.

There is significant work in the project related to design, engineering and operation of process equipment and systems in safe manner. In an increasingly rigorous public health environment, the safe handling and processing of uranium hexafluoride and resulting fluoride products are of utmost importance. Those needs are being met in the IIFP facility through a strong environmental safety and health (ESH) design philosophy and synergy of the design and licensing teams. A concurrent engineering approach is being

implemented for licensing, development, safety analysis, environmental assessment, and the design and engineering activities.

IIFP is committed to designing, constructing and operating a facility that meets all environmental regulatory requirements, minimizes the environmental impact and is safe to both the public and employees. For example, gaseous or particulate emissions from process equipment are cleaned or captured using multi-stage scrubbing or particulate collection systems. The systems are configured in series to ensure the desired efficiency of removal and also to provide back-up protection if operational parameters were to deviate from the normal. Chemical treating solutions used in cleaning air emissions are regenerated in an environmental protection process (EPP) and recycled for reuse in the air emission scrubber systems. Most of these redundant systems are not required to meet environmental standards but are incorporated because of IIFP's stringent philosophy for eliminating, as much as possible, any discharge to the environment.

The strategy of minimizing impacts to the environment, safety and health are addressed through an engineering design philosophy that includes: 1) minimizing inventories of chemicals stored on site and subsequently minimizing source terms, 2) installing secondary containment of potential chemical hazards where needed, 3) minimizing the use of intake water, 4) adopting a process water zero-discharge to the environment design, 5) re-circulation and re-use of necessary cooling water, 6) double-contingency and redundancy on selected key systems, 7) defense-in-depth layers of protection with first priority on engineered controls where needed, 8) multi-treatment devices configured in series, and 9) "green" techniques for providing alternative energy supply sources where feasible.

1.3.2.1 Design Basis and Philosophy for Minimum Environmental Impact

The design philosophy and subsequent engineering control criteria for the overall plant relative to Environmental, Safety, and Health (ESH) include:

- Water intake and its usage are minimized; currently estimated at an average of 3 to 4.5 thousand gallons per day.
- Design and engineering with respect to seismic events and consequences is being based on "g-force" lateral movement relative to a minimum 2,500-year return period.
- Solar panels are used where feasible to power selected outside and building lighting and some auxiliaries.
- Ground water source heat pump loops are designed and installed where feasible to provide heat and cooling to auxiliary buildings.
- Uranium hexafluoride cylinders are controlled inside a containment-type autoclave when being heated or fed to the process. DUF₆ cylinders are not lifted or transported when the material inside the cylinder is in a liquid state.
- Air coolers or chillers are used to achieve the desired cooling temperatures by recirculation in the process, thereby avoiding once-through cooling water directly or indirectly.
- Air emission sources are controlled and minimized by using 2-3 stage in-series scrubber and dust collection systems for gaseous emissions and particulates, respectively for in-depth layers of control.
- Wastewater is minimized at the point source with a design target of no process water discharge to surface waters or ground. Process water is treated and recycled for reuse in the scrubber systems or for return as make-up water to some processes. This water treatment facility is called the Environmental Protection Process (EPP).
- Areas where AHF is collected or stored and where significant AHF potential source terms are involved are in a containment-type building that includes fluoride detection, automatic

- isolation valves, and automatic water deluge spray system. Likewise, packaging areas where truck tube-trailers for AHF and FEP products are loaded are inside a containment-type building including detection, automatic isolation valves and water deluge spray system. Packaging of SiF₄ or BF₃ into small customer-owned cylinders is performed inside enclosed packaging manifolds and vented to an emergency scrubber in event of a leak or release.
- Dust collection systems are designed to capture solid uranium particulate materials at the source and to eliminate spread of those materials during maintenance.
 - Purge and evacuation systems are included to control emissions prior to and during opening of equipment and systems that may contain hazardous vapors or gases.
 - Exhaust hood and capture systems are located in selected general areas where there are hazardous materials to provide back-up emergency control and evacuation in event of leak. Exhausts are sent to a scrubbing system to treat the emission.
 - Process areas where chemicals or hazardous materials are stored or processed are provided where applicable with pad areas including containment-type dikes or curbing. Pumps and conduits are installed for transporting leaked or spilled materials either back to storage or to the EPP for treatment.
 - Containment-type hoods and boxes are used where withdrawal of hazardous material samples are taken for necessary analysis.
 - Storm water sewer systems are designed for a 100-year return period maximum 1-hour rainstorm. Storm water runoff is collected in double-lined retention (evaporation) basins with capacity equal to or greater the 100-year case.
 - Sanitary water usage is minimized by design of water-saving shower, lavatory and toilet fixtures. Sanitary wastewater is tertiary treated, with resulting biomass sent to a licensed receiving off-site facility. Treated sanitary water is either evaporated or used on site for landscape or tree watering.

1.3.2.2 Design Basis Standards and Codes

The primary applicable codes and standards (editions applicable at time of design) for the design and building requirements of the IIFP Facility include the following:

- Uniform Plumbing Code (UPC) as amended by the New Mexico Plumbing Code (NMPC).
- International Energy Conservation Code (IECC) as amended by the New Mexico Energy Conservation Code (NMECC).
- Uniform Mechanical Code (UMC) as amended by the New Mexico Mechanical Code (NMMC).
- International Building Code (IBC) as amended by the New Mexico Commercial Building Code (NMCBC).
- National Electrical Code (NEC) as amended by the New Mexico Electrical Code (NMEC).
- International Fire Code (IFC).
- NFPA 10 Portable Fire Extinguishers.
- NFPA 13 Installation of Sprinkler Systems.
- NFPA 20 Installation of Stationary Pumps for Fire Protection.
- NFPA 22 Water Tanks for Private Fire Protection.
- NFPA 24 Installation of Private Fire Service Mains and Their Appurtenances.
- NFPA 45 Fire Protection for Laboratories Using Chemicals.
- NFPA 54 National Fuel Gas Code.

- NFPA 55 Storage, Use and Handling of Compressed Gases and Cryogenic Fluids in Portable and Stationary Containers, Cylinders and Tanks.
- NFPA 72 National Fire Alarm Code.
- NFPA 85 Boiler and Combustion Systems Hazards Codes.
- NFPA 90A Installation of Air-conditioning and Ventilating Systems.
- NFPA 90B Installation of Warm Air Heating and Air-conditioning Systems.
- NFPA 101 Life Safety Code – 2006 Edition.
- NFPA 110 Emergency and Standby Power Systems.
- NFPA 430 Storage of Liquid and Solid Oxidizers
- NFPA 780 Installation of Lightning Protection Systems.
- NFPA 801 Fire Protection for Facilities Handling Radioactive Materials.
- ASME/ANSI B16 Standard for Pipe and Fittings.
- ASME/ANSI B31 Pressure Piping (includes, power piping, process piping, gas piping, etc.).
- ASME Section VIII, Div 1 Design and Fabrication of Pressure Vessels. Latest Edition.
- API 620 Design and Fabrication of Atmospheric Storage Tanks.
- AISC Standards for Steel Construction.
- ASTM Standards for Steel Building Construction.
- ACI for Concrete Construction.

The abbreviations of the organizations for the codes and standards are listed in Table 1-3.

Table 1- 3 Abbreviations for Codes and Standards

Code/Standard	Organization
NFPA	National Fire Protection Association
ASME	American Society of Mechanical Engineers
ANSI	American National Standards Institute
API	American Petroleum Institute
AISC	American Institute of Steel Construction
ASTM	American Society for Testing and Materials
ACI	American Concrete Institute

1.3.3 The Proposed Site

The Proposed IIFP Site is located in a 640-acre Section of Southeast New Mexico, approximately 23 km (14 mi) west of Hobbs, New Mexico (population 28,657). The site is located in Lea County, approximately 27 km (17 mi) west of the Texas state border, 85 km (53 mi) northwest of Andrews, Texas (population 10,182) and 308 km (242 mi) southeast of Albuquerque, New Mexico (population 712,728). The nearest large population center (>100,000 population) and commercial airport is the Midland-Odessa, Texas area which is approximately 134 km (83 mi) to the southeast. See Figure 1-4, “IIFP Location in Southeastern New Mexico.”

Lea County is situated with elevations varying from approximately 884 m (2,900 ft) in the southeast to approximately 1341 m (4,400 ft) in the northwest with an average elevation of 1,220 m (4,000 ft) above mean sea level (msl). Lea County covers 11,381 km² (4,393 mi²) or approximately 1,138,114 ha (2,822,522 acres) which is three times the size of Rhode Island and only slightly smaller than Connecticut. From north to south, Lea County spans 173 km (108 mi); the county spans 70 km (44 mi) from east to west at its widest point.

The site is located approximately 23 km (14 mi) west of the nearest city, which is Hobbs, New Mexico (population 28,657). The site lies along the north side of U.S. Highways 62/180 (U.S. 62/180) and the east side of New Mexico Highway 483 (NM 483). Refer to Figure 1-5, "Location of the Proposed IIFP Site." U.S. 62/180 intersects NM 18 providing access from the city of Hobbs south to Eunice and Jal. New Mexico 132 runs north from Hobbs at the intersection with U.S 62/180 to Knowles and Denver City.

The Proposed IIFP Site location will be carved out of 958.7 ha (2,369 ac) in Township 18S, Range 37E, Sections 26, 27, 34, and 35. The approximate center of the IIFP Site is located approximately at latitude 32 degrees and 43 min North and 103 degrees and 20 min West longitude.

U.S. 62/180 runs southwest to Carlsbad, New Mexico, approximately 50 miles from the proposed site. U.S. 62/180 runs east through Seminole, Texas, 28 miles from Hobbs to Forth Worth, Texas, 340 miles from the site.

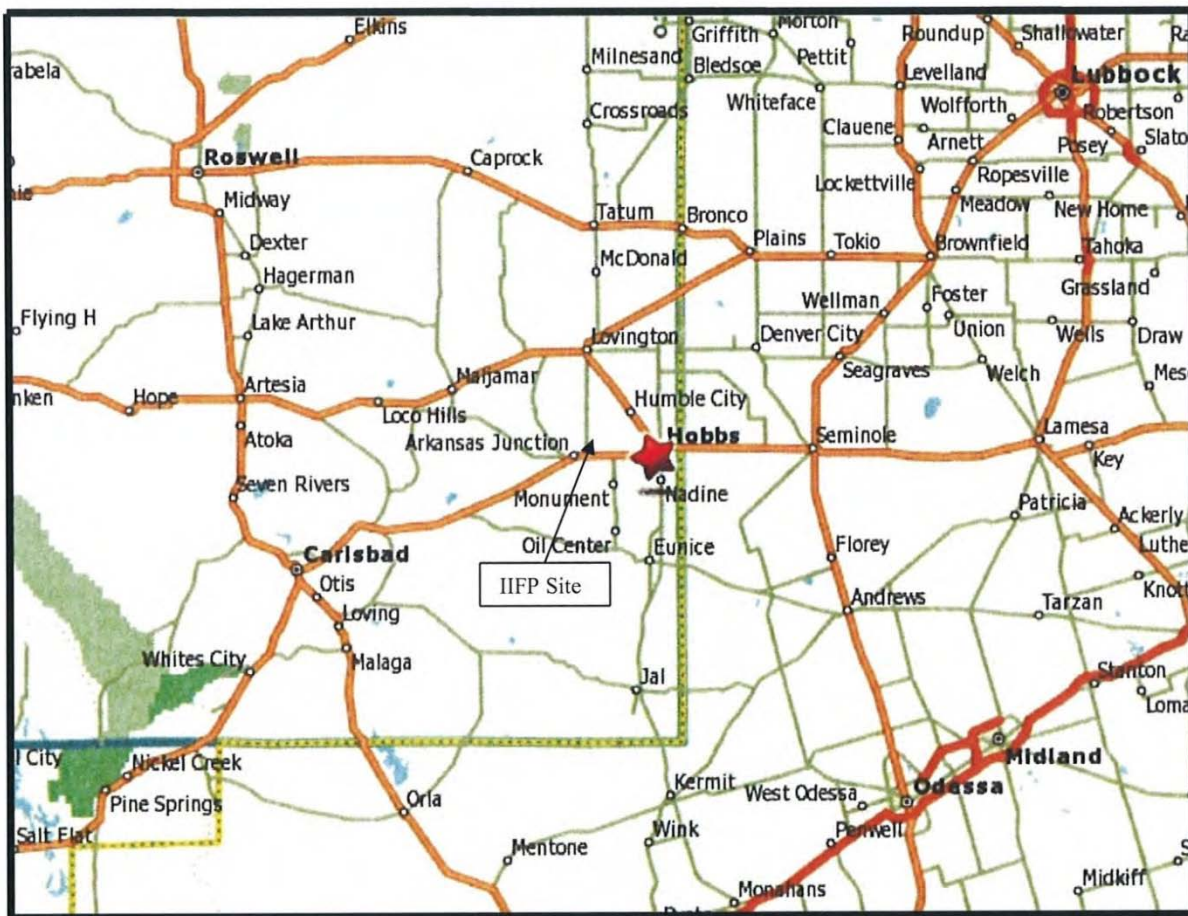

Figure 1- 4 IIFP Location in Southeastern New Mexico

The IIFP Site is currently owned by the State of New Mexico and is being transferred to Lea County and then will be transferred to INIS for use for construction of this project. The transfer process is expected to be completed by the end of 2009. In the interim, the State of New Mexico has granted a 6-month right of access to the property. A preliminary archeological survey and legacy characterization of the property has been completed. See Section 1.4.7, "Surveys Conducted," for the Phase I Environmental Site Assessment

for information on the legacy characterization of the site. For complete details for the archeological survey, see Section 3.8.2, “Archaeological or Historic Surveys.”

The site is undeveloped and some portions utilized by the oil and gas and the electrical industries. Several power lines and underground power lines run generally east to west and several gas pipelines run north and west as well as east to west. See Section 1.4.7, “Surveys Conducted,” for a listing of transmission lines, pipelines, and other miscellaneous structures and facilities on the site.

Surrounding property consists of vacant land and the industrial Xcel Energy Cunningham Station on the west boundary (NM 483) of the IIFP proposed property line, Xcel Energy Maddox Station on the east side, and Colorado Energy Station on the northeast of the site. Cattle grazing, on nearby sites, occurs throughout the year. Land around the proposed site has been mostly developed by the oil and gas industry. The nearest residence is situated at the northeast of the Site approximately 8.5 km (5.3 mi) from the northern boundary. There are no known public recreational areas within 8 km (5 mi) of the Site.

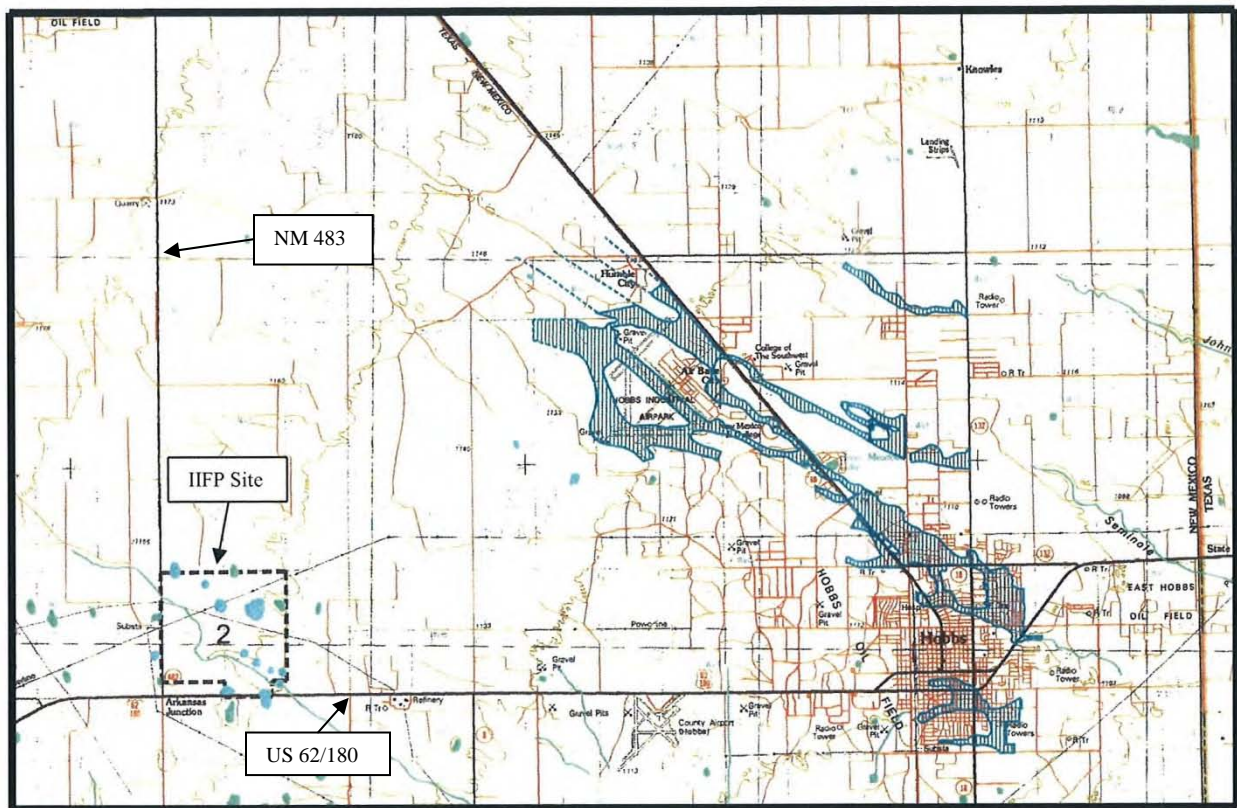

Figure 1- 5 Location of the Proposed IIFP Site

1.4 Applicable Regulatory Requirements and Status

In addition to the NRC licensing and regulatory requirements, a variety of environmental regulations apply to the IIFP plant during the construction and operational phases. These regulations require permits from, consultations with, or approvals by, other governing or regulatory agencies.

1.4.1 Federal Agencies

This section describes the Federal laws, regulations, Executive Orders, and agencies that apply or are involved with licensing and permitting of the IIFP Facility. The facility is privately owned and operated. Under this scenario, NRC is the licensor of the facility.

1.4.1.1 *National Environmental Policy Act*

The *National Environmental Policy Act* (NEPA) of 1969, as Amended (42 U.S.C. §4321 et seq.) establishes national environmental policy and goals for the protection, maintenance, and enhancement of the environment to ensure all Americans a safe, healthful, productive, and aesthetically and culturally pleasing environment. NEPA provides a process for implementing these specific goals within the Federal agencies responsible for the action. As part of the licensing process for the proposed facilities, the NRC will prepare an Environmental Impact Study (EIS) in accordance with the NEPA requirements and NRC regulations [10 Part 51; CFR, 2009d] for the implementing NEPA.

1.4.1.2 *Atomic Energy Act*

The *Atomic Energy Act*, of 1954, as amended (42 U.S.C. §2011 et seq.) and the *Energy Reorganization Act of 1974* (42 U.S.C. §5801 et seq.) give the NRC the licensing and regulatory authority for nuclear energy uses within the commercial sector. When the license application for the proposed facilities is approved, the NRC would license and regulate the possession, use, storage, and transfer of licensed nuclear materials to protect public health and safety as stipulated in 10 CFR Parts 20, 30, 40, and 70 (CFR, 2009b; CFR, 2009c; CFR, 2009f).

The primary governing regulations would be: a) 10 CFR Part 40 (CFR, 2009c), “Domestic Licensing of Source Material,” which provides requirements for a license to possess and use source nuclear materials and b) applicable parts 10 CFR Part 70, “Domestic Licensing of Special Nuclear Material,” specifically Subpart (H) (CFR, 2009f). Subpart (H) particularly addresses requirements in paragraph 70.61 and 70.72 as those pertaining to performance requirements, safety program, and Integrated Safety Analysis (ISA).

Other applicable regulations include 10 CFR Part 20 (CFR, 2009a), “Standards for Protection against Radiation,” 10 CFR Part 30 (CFR, 2009b), “Rules of General Applicability to Domestic Licensing of By-product Material,” and 40 CFR 71 (CFR, 2009m), “Packing and Transportation of Radioactive Material.” Either of the primary regulations, 10 CFR Part 40 or 10 CFR Part 70, invoke Appendix B of 10 CFR Part 50 for “Quality Assurance,” where applicable, 10 CFR Part 51 (CFR, 2009d) for implementation of NEPA for NRC decisions on granting licenses, and 10 CFR Parts 73, 74, and 75 for physical protection, material control and accountability, and International Atomic Energy Agency (IAEA) requirements, if applicable. Other NRC regulations such as 10 CFR Parts 2, 10, 11, 25, 26, 95, 170 and 171 may apply in the licensing process, such as security, special nuclear material access authorization, fitness-for-duty, NRC fees, and other programs required for the license.

The NRC principal guidance documents being followed by IIFP personnel for environmental assessment and safety analysis in developing the license application are: 1) the “Standard Review Plan for the Review of a License Application for a Fuel Cycle Facility,” NUREG-1520, Final Report, (NRC, 2002c) or most recent revision, and 2) the “Environmental Review Guidance for Licensing Actions Associated with NMSS Programs,” NUREG 1748, Final Report, (NRC, 2003a), or most recent revision.

1.4.1.3 Clean Air Act

The *Clean Air Act* (CAA) as Amended (42 U.S.C. §7401 et seq.) establishes regulations to ensure air quality and authorizes individual States to manage permits. The Clean Air Act: (1) requires the EPA to establish NAAQS as necessary to protect the public health with an adequate margin of safety, from an known or anticipated adverse effects of a regulated pollutant (42 U.S.C. §7409 et seq.); (2) requires establishment of national standards of performance for new or modified stationary sources of atmospheric pollutants (42 U.S.C. §7411); (3) requires specific emission increases to be evaluated so as to prevent a significant deterioration in air quality (42 U.S.C. §7470 et seq.); and (4) requires specific standards for releases of hazardous air pollutants (including radionuclides) (42 U.S.C. §7412). These standards are implemented through implementation plans developed by each State with EPA approval. CAA requires sources to meet air quality standards and obtain permits to satisfy those standards. CCA authority has been delegated to the state of New Mexico.

1.4.1.4 Clean Water Act

The *Clean Water Act* (CWA) as amended (33 U.S.C. §1251 et seq.) requires the EPA to set national effluent limitations and water-quality standards, and establishes a regulatory program for enforcement. Specifically, Section 402(a) of the Act establishes water-quality standards for contaminants in surface waters. The CWA requires a National Pollutant Discharge Elimination System (NPDES) permit before discharging any point source pollutant into waters of the U.S. EPA Region 6 administers this program with an oversight review by the New Mexico Environment Department Water Quality Bureau (NMED/WQB). The NPDES General Permit for Industrial Stormwater is required for point source discharge of stormwater runoff from industrial or commercial facilities to State waters. Construction of the proposed facilities would require an NPDES Construction Stormwater General Permit from EPA Region 6 and an oversight review by the NMED/WQB. Section 401 of the CWA requires States to certify that the permitted discharge would comply with all limitations necessary to meet established State water-quality standards, treatment standards, or schedule of compliance. Section 404 of the CWA requires a permit to place dredged or fill material into waters of the U.S. The EPA implements the CWA in 40 CFR 100-135.

In April 2004, the State of New Mexico began the process of assuming NPDES permitting responsibilities within the State (NMED, 2004a). Jurisdiction would be transferred from the EPA Region 6 to the New Mexico Environment Department Surface Water Quality Bureau. After the transfer of jurisdiction is complete, State implementation of NPDES permitting would be phased in over a five-year period (NMED, 2004b).

1.4.1.5 Resource Conservation and Recovery Act

The *Resource Conservation and Recovery Act* (RCRA) as Amended (42 U.S.C. §6901 et seq.) requires the EPA to define and identify hazardous waste; establish standards for its transportation, treatment, storage, and disposal; and require permits for persons engaged in hazardous waste activities. Section 3006 of the RCRA (42 U.S.C. §6926) allows States to establish and administer these permit programs with EPA approval. EPA Region 6 has delegated regulatory jurisdiction to the New Mexico Environment Department Hazardous Waste Bureau for nearly all aspects of permitting in accordance with the New Mexico Hazardous Waste Act. Regulations imposed on a generator or on a treatment, storage, and/or disposal facility vary according to the type and quantity of material or waste generated, treated, stored, and/or disposed. IIFP plans to sell CaF₂ that is a by-product of the process water treatment and recycle. The Proposed IIFP Facility may be classified as a large quantity generator of hazardous waste (meaning it is expected to generate more than 1,000 kg (2,200 lb) of such waste per month) in the event that the CaF₂

generated at the EPP is not sold as a by-product. See Section 4.13, “Waste Management Impacts.” Hazardous wastes are not disposed of on site; instead, IIFP plans to store any RCRA wastes on site for less than 90 days and then transfer the waste to appropriately permitted treatment, storage, and disposal facilities.

The RCRA addresses underground storage tanks (USTs) containing petroleum products or hazardous chemicals. The NMED has also been authorized to by EPA to regulate USTs in accordance with 20.5 NMAC. NMED also regulates above ground petroleum storage tanks. There is no UST at the IIFP facility site.

1.4.1.6 *Low-Level Radioactive Waste Policy Act*

The *Low-Level Radioactive Waste Policy Act of 1980* as Amended (42 U.S.C. §2021 et seq.) amended the Atomic Energy Act to specify that the Federal Government is responsible for disposal of low-level radioactive waste generated by its activities. States are responsible for non-federal low-level radioactive waste generated in their state. The *Low-Level Radioactive Waste Policy Act of 1980* provides for and encourages interstate compacts to carry out the State responsibilities. Low-level radioactive waste would be generated from activities conducted from the proposed facilities. Low-Level radioactive waste from the IIFP facility will be sent to a licensed disposal facility.

1.4.1.7 *Emergency Planning and Community Right-to-Know Act*

The *Emergency Planning and Community Right-to-Know Act of 1986*, 42 U.S.C. §11001 et seq., (also known as *Superfund Amendments and Reauthorization Act (SARA) Title III*) which is the major amendment to the *Comprehensive, Environmental Response, Compensation, and Liability Act (CERCLA)* (42 U.S.C. § 9601), establishes the requirements for the Federal, State, and local governments, Indian tribes, and industry regarding emergency planning and “Community Right-to-Know” reporting on hazardous and toxic chemicals. The “Community Right-to-Know” provisions increase the public’s knowledge and access to information on chemicals at individual facilities, their uses, and releases into the environment. States and communities working with facilities can use the information to improve chemical safety and protect public health and the environment. This Act requires emergency planning and notice to communities and government agencies concerning the presence and release of specific chemicals. IIFP has prepared an Emergency Plan, received comments from local community emergency service organization relative to this plan. The EPA implements this Act under regulations found in 40 CFR Parts 355, 370, and 372 (CFR, 2009ff). This Act requires the proposed facilities to report on hazardous and toxic chemicals used and produced at the facility, and to establish emergency planning procedures in coordination with the local communities and government agencies. New Mexico has parallel legislation.

1.4.1.8 *Safe Drinking Water Act*

The *Safe Drinking Water Act (SDWA)* as Amended (42 U.S.C. §300f et seq.) was enacted to protect the quality of public water supplies and sources of drinking water. The New Mexico Environment Department Drinking Water Bureau, under 42 U.S.C. §300g-2 of the Act, established standards applicable to public water systems. These regulations include maximum contaminant levels (including those for radioactivity) in public water systems. Other programs established by the SDWA include the Sole Source Aquifer Program, the Wellhead Protection Program, and the Underground Injection Control Program. In addition, the Act seeks to protect underground sources of drinking water from contaminated releases and spills (for example, implementing a Spill Prevention Control and Countermeasure Plan). The EPA-delegated authority is responsible for ensuring compliance with the SDWA’s national Primary Drinking Water Standards by approving the NMED’s Drinking Water Regulations (DWRs). IIFP plans to have two

wells into the Ogallala Aquifer and a small packaged water treatment facility that will meet the SDWA requirements.

1.4.1.9 *Noise Control Act*

The *Noise Control Act of 1972*, as Amended (42 U.S.C. §4901 et seq.) delegates the responsibility of noise control to state and local governments. Commercial facilities are required to comply with Federal, State, interstate, and local requirements regarding noise control. Lea County does not have a local noise control ordinance. Design of equipment will consider noise control as a key design element. Based on the current design concept, there is no significant concern that IIFP processes and equipment would present unique issues with respect to noise control.

1.4.1.10 *National Historic Preservation Act*

The *National Historic Preservation Act* (NHPA) of 1966, as Amended (16 U.S.C. §470 et seq.) was enacted to create a national historic preservation program, including the National Register of Historic Places and the Advisory Council on Historic Preservation (ACHP). Section 106 of the NHPA requires Federal agencies to take into account the effects of their undertakings on historic properties. The Advisory Council on Historic Preservation regulations implementing Section 106, found in 36 CFR Part 800, were revised and became effective on August 5, 2004. These regulations call for public involvement in the Section 106 consultation process, including Indian tribes and other interested members of the public, as applicable. No major issue is identified that would preclude licensing and permitting the proposed site.

1.4.1.11 *Endangered Species Act*

The *Endangered Species Act (ESA) of 1973*, as Amended (16 U.S.C. §1531 et seq.) was enacted to prevent further decline of endangered and threatened species and to restore those species and their critical habitats. Section 7 of the Act requires consultation with either or both the U.S. Fish and Wildlife Services (USFWS) of the U.S. Department of the Interior and the National Marine Fisheries Service of the U.S. Department of Commerce to determine whether endangered and threatened species or their critical habitats are known to be in the vicinity of the Proposed Action. There is no known threatened or endangered species on the Site. The State of New Mexico has similar legislation.

1.4.1.12 *Occupational Safety and Health Act*

The *Occupational Safety and Health Act of 1970*, as Amended (29 U.S.C. §651 et seq.) establishes standards to enhance safe and healthy working conditions in places of employment throughout the United States. The Act is administered and enforced by the Occupational Safety and Health Administration (OSHA), a U.S. Department of Labor agency. The identification, classification, and regulation of potential occupational carcinogens are found in 29 CFR §1990.101 (CFR, 2009mm), while the standards pertaining to hazardous materials are listed in 29 CFR §1910.120 (CFR, 2009g). The OSHA regulates mitigation requirements and mandates proper training and equipment for workers. New Mexico implements State OSHA statutes. The Proposed IIFP Facility complies with required the requirements of these regulations.

1.4.1.13 *Hazardous Materials Transportation Act*

The *Hazardous Materials Transportation Act* (49 U.S.C §1801 et seq.) regulates transportation of hazardous material (including radioactive material) in and between States. According to the Act, States may regulate the transport of hazardous material as long as they are consistent with the Act or the U.S.

Department of Transportation (DOT) regulations provided in 49 CFR Parts 171-177 (CFR, 2009hh; CFR, 2009ii; CFR, 2009ii). Title 49 CFR Part 173, Subpart I, contains regulations regarding packaging for transportation of radionuclides. Transportation of the hazardous material (including radioactive material) to and from the proposed facilities requires compliance with the DOT regulations.

1.4.1.14 Environmental Standards for Uranium Fuel Cycle

These regulations (40 CFR Part 190, Subpart B) (CFR, 2009u) establish the maximum doses to the body or organs resulting from operational normal releases received by members of the public. These regulations were promulgated under the authority of the *Atomic Energy Act of 1954*, as amended and have been incorporated by reference in the NRC regulations in 10 CFR §20.1301(e). Portions of the proposed facilities require compliance with these regulations for any emissions from normal operations.

1.4.1.15 National Emission Standards for Hazardous Air Pollutants

The IIFP Site is being licensed by the NRC. Subsequently, radionuclide releases in “National Emission Standards for Hazardous Air Pollutants” (NESHAPS) (40 CFR Part 61; CFR, 2009k) are likely to be exempt from NESHAPS in accordance with Subpart I. During the federal and State permitting process, any changes in NESHAPS requirements will be re-evaluated.

1.4.2 Applicable Executive Orders

1.4.2.1 *Executive Order 11514*

This Executive Order (EO, 1970) directs Federal agencies to monitor and control their activities to protect and enhance the quality of the environment. It also requires the agencies to include the public in the decision-making process for agency actions. The public will be included in any environmental evaluations performed by NRC.

1.4.2.2 *Executive Order 11988*

This Executive Order (EO, 1977) directs Federal agencies to establish procedures to ensure that the potential effects of flood hazards and floodplain management are considered for any action undertaken in a floodplain and that floodplain impacts be avoided to the extent practicable. The proposed facilities are not within a floodplain.

1.4.2.3 *Executive Order 12898*

This Executive Order (EO, 1994) requires Federal agencies to address environmental justice in minority populations and low-income populations (59 FR 7629), and directs Federal agencies to identify and address, as appropriate, disproportionately high and adverse health or environmental effects of their programs, policies, and activities on minority populations and low-income populations. In response to this Executive Order, the NRC has issued a final policy statement on the “Treatment of Environmental Justice Matters in NRC Regulatory and Licensing Actions” (69 FR 52040; August 24, 2004) and environmental justice procedures to be followed in NEPA documents prepared by the NRC’s Office of Nuclear Material Safety and Safeguards. No environmental justice related issues have been identified that would preclude licensing the IIFP facility.

1.4.2.4 Executive Order 13007

This Executive Order (EO, 1996) directs Federal agencies to protect and preserve American Indian Tribes' religious practices by providing access to and ceremonial uses of sacred sites by Tribal religious practices where feasible and permitted by law. This Order also states that Federal agencies will maintain government-to-government relations with Tribal governments. The NRC will contact regional federally recognized Indian tribes, soliciting their interest in being consulting parties in the consultation process for the proposed project.

1.4.2.5 Executive Order 13175

This Executive Order (EO, 2000) directs Federal agencies to establish processes to ensure meaningful and timely input through consultation and collaboration with Tribal officials in the development of regulatory policies that have Tribal implications. The NRC would contact regional federally recognized Indian tribes, to solicit any interest they may have as with Executive Order 13007 above.

1.4.3 Involved Federal Agencies

1.4.3.1 Nuclear Regulatory Commission

The *Atomic Energy Act of 1954*, as amended, gives the NRC regulatory jurisdiction over the design, construction, operation, and decommissioning of the facility specifically with regard to assurance of public health and safety. The NRC would perform periodic surveillance of construction, operation, and maintenance of the plant.

The NRC establishes standards for protection against radiation hazards arising out of licensed activities. The NRC licenses are issued pursuant to the Atomic Energy Act of 1954, as amended, and the *Energy Organization Act of 1974*. The regulations apply to all persons who receive, possess, use or transfer licensed materials.

The NRC has already established a project manager within their agency for the IIFP project. NRC and IIFP have met a number of times and have conducted discussions face-to-face and by telephone and electronic media. IIFP has apprised the NRC and their project manager of the IIFP project description, schedule and licensing work methodologies that are underway. The NRC is expecting the license applications to be submitted per the schedule. They are preparing to have resources available within the timeframe of the IIFP projected schedule to conduct that review and approval activity.

1.4.3.2 U.S. Environmental Protection Agency

The EPA has primary authority relating to compliance with the CAA, CWA, SDWA, and RCRA. Except for the CWA, EPA Region 6 has delegated regulatory jurisdiction to the New Mexico Environment Department (NMED) Hazardous Waste Bureau (HWB) for nearly all aspects of permitting, monitoring, and reporting activities relating to these statutes and associated programs.

“Environmental Standards for the Uranium Fuel Cycle” (40 CFR 190.10 Subpart B (a)) establishes the maximum doses to the body organs resulting from operational normal releases and received by members of the public. “The annual dose equivalent does not exceed 25 millirems to the whole body, 75 millirems to the thyroid, and 25 millirems to any other organ of any member of the public as a result of planned discharges of radioactive materials, radon and its daughters excepted, to the general environment from uranium fuel cycle operations and to radiation from operations.”

SDWA provides for protection of public water supply systems and underground sources of drinking water. 40 CFR 141.2 (CFR, 2009t) defines public water supply systems as systems that provide water for human consumption to at least 25 people or at least 15 connections. Underground sources of drinking water are also protected from contaminated releases and spills by this act. The proposed facilities use site groundwater to treat for potable water.

The *Emergency Planning and Community Right-to-Know Act of 1986* (40 CFR 350 to 372) establishes the requirements for Federal, State, and local governments, Indian Tribes, and industry regarding emergency planning and “Community Right-to-Know” reporting on hazardous and toxic chemicals. The Community Right-to-Know provisions help increase the public’s knowledge and access to information on chemicals at individual facilities, their uses, and releases into the environment. States and communities, working with facilities, can use the information to improve chemical safety and protect public health and the environment.

NPDES General Permit for Industrial Stormwater is required for point source discharge of stormwater runoff from industrial or commercial facilities to the waters of the state. All new and existing point source industrial stormwater discharges associated with industrial activity require a NPDES Stormwater Permit from the EPA Region 6 and an oversight review by the New Mexico Water Quality Bureau. Most common is a general permit which is available to almost any industry, but there is also an option to obtain an individual NPDES permit.

A NPDES General Permit for Construction Stormwater is required since construction of the facility will involve the grubbing, clearing, grading or excavation of more than 1 acre of land. This will require a NPDES Construction Stormwater General Permit (CGP) from the EPA Region 6 and an oversight review by the NMED/WQD. Various land clearing activities such as off-site burrow pits for fill material may also be covered under this general permit. As part of this permitting process, a Stormwater Pollution Prevention Plan (SWPPP) will be developed and a Notice of Intent (NOI) will be filed with the EPA at least two days prior to the commencement of construction activities.

1.4.3.3 U.S. Department of Transportation

Transport of licensed nuclear materials and hazardous chemicals requires compliance with DOT enabling regulations including the following:

- 49 CFR 107, Hazardous Materials Program Procedures, Subpart G: “Registration and Fee to DOT as a Person who Offers or Transports Hazardous Materials.”
- 49 CFR 171, “General Information, Regulations and Definitions.”
- 49 CFR 172, “Hazardous Materials Table, Special Provisions, Hazardous Materials Communications, Emergency Response Information, Training Requirements and Security Plans.”
- 49 CFR 173, Shippers-General Requirements for Shipments and Packages, Subpart I: “Radioactive Materials.”
- 49 CFR 177, “Carriage by Public Highway.”
- 49 CFR 178, “Specification for Packaging.”
- 49 CFR 173.301, “Compressed Gas.”

All provisions of these enabling regulations will be met prior to the transport of any licensed nuclear material.

1.4.3.4 U.S. Army Corps of Engineers

CWA established a permit program under Section 404 to be administered by the U.S. Army Corps of Engineers (USACE) to regulate the discharge of dredged or fill material into “the waters.” The USACE also evaluates wetlands, floodplains, dam inspection, and dredging of waterways. The proposed facilities construction site does not impact or involve any wetlands, surface waters, dams, or other waterways.

1.4.3.5 Occupational Safety and Health Administration

The *Occupational Safety and Health Act of 1970* became law in order to increase the safety of workers in the workplace. It provides that the Department of Labor establish employee safety and health standards. Applicable regulations are found in 29 CFR 1910 (CFR, 2009g) for general industry and 29 CFR for construction activities. OSHA regulates mitigation requirements and mandates proper training and equipment for workers. The IIFP Occupational Safety and Health (OSH) Program, documentation and implementing procedures will be developed and implemented within the applicable OSHA requirements.

1.4.3.6 U.S. Department of Interior

The U.S. Fish and Wildlife Service (USFWS) will be responsible for the protection of threatened and endangered species. Currently, there is no known threatened or endangered species on the selected facility Site.

1.4.4. State Agencies

This section describes the State laws, regulations, and agencies that would apply or be involved with licensing and permitting at the Site.

1.4.4.1 *New Mexico Air Quality Control Act*

New Mexico Statutes Annotated (NMSA), Chapter 74, “Environmental Improvement,” Article 2, “Air Pollution,” and implementing regulations in NMAC Title 20, Environmental Protection, Chapter 2, “Air Quality,” establishes air-quality standards and permit requirements prior to construction or modification of an air-contaminant source. These regulations also define requirements for an operating permit for major producers of air pollutants and impose emission standards for hazardous air pollutants.

1.4.4.2 *New Mexico Radiation Protection Act*

NMSA, Chapter 74, Article 3, “Radiation Control,” establishes State requirements for worker protection from radiation sources. If the facilities are privately owned, the State will require registration of security X-ray machines. The implementation regulations are in NMAC, Title 20, Chapter 3.

1.4.4.3 *New Mexico Water Quality Act*

NMSA, Chapter 74, Article 6, “Water Quality,” and implementing regulations found in NMAC Title 20, Chapter 6, “Ground and Surface Water Protection,” establishes water-quality standards and applies to permitting prior to construction, during operation, closure, post-closure, and abatement, if necessary. Generally, a permit is required for discharges that could impact surface or ground water. Any impoundments for sewage treatment facilities, cooling water or other discharges that exceed the standards

listed in 20.6.2.3103 NMAC or contain toxic constituents require a permit. No environmental or site issues were identified that would preclude permitting the facilities at the Site.

1.4.4.4 *New Mexico Groundwater Protection Act*

NMSA, Chapter 74, Article 6B, “Groundwater Protection,” and the implementing regulations found at NMAC Title 20, Chapter 5, establishes State standards for protection of groundwater from leaking underground and above ground storage tanks.

1.4.4.5 *New Mexico Hazardous Waste Act*

NMSA, Chapter 74, Article 4, “Hazardous Waste,” and implementing regulations found in NMAC Title 20, Environmental Protection, Chapter 4, “Hazardous Waste,” establishes state standards for the management of hazardous wastes. The NMED regulations implementing the Resource Conservation Recovery Act (RCRA) are found in NMAC Title 20 Chapter 4 (NMAC, 2009) Regulations imposed on a generator or on a treatment, storage, and/or disposal (TSD) facility vary according to the type and quality of material or waste generated, treated, stored, and/or disposed. The method of treatment, storage, and/or disposal also impacts the extent and complexity of the requirements. The IIFP plant may generate hazardous waste during construction and operation. These hazardous wastes will be temporarily stored and shipped off site for treatment and disposal in accordance with applicable NMAC and RCRA requirements. Source, special nuclear or by-product material as defined by the Atomic Energy Act is specifically excluded from the definition of a solid waste and therefore is not a hazardous waste regulated under RCRA.

The IIFP facilities will not store (other than temporarily) or dispose of hazardous waste on site. IIFP may need a permit for operation of its Environmental Protection Process under the authority of RCRA or the New Mexico Hazardous Waste Act; requiring further review with the state.

1.4.4.6 *New Mexico Hazardous Chemicals Information Act*

NMSA, Chapter 4, Article 4E-1, *Hazardous Chemicals Information Act*, implements the hazardous chemicals information and toxic release reporting requirements of the Emergency Planning and Community Right-to-Know Act of 1986 (Superfund Amendments and Reauthorization Act (SARA) Title III) for covered facilities.

1.4.4.7 *New Mexico Wildlife Conservation Act*

NMSA, Chapter 17, Game and Fish, Article 2, “Hunting and Fishing Regulations,” and Part 3, “Wildlife Conservation Act,” requires a permit and coordination if a project may disturb habitat or otherwise affect threatened or endangered species. There is at this time no known threatened or endangered species on the Site.

1.4.4.8 *New Mexico Raptor Protection Act*

NMSA, Chapter 17, Articles 2-14 makes it unlawful to take, attempt to take, possess, trap, ensnare, injure, maim, or destroy any species of hawks, owls, and vultures.

1.4.4.9 *New Mexico Endangered Plant Species Act*

NMSA, Chapter 75, “Miscellaneous Natural Resource Matters,” Article 6, “Endangered Plants,” requires coordination with the state if a proposed project affects an endangered plant species. There is at this time no known threatened or endangered species occurring on the selected plant Site

1.4.4.10 *Threatened and Endangered Species of New Mexico*

NMAC Title 19, Natural Resources and Wildlife, Chapter 33, “Endangered and Threatened Species,” 19.33.6.8, establishes the list of threatened and endangered wildlife species. There is at this time no known threatened or endangered species on the selected plant Site.

1.4.4.11 *Endangered Plant Species*

NMAC Title 19, Chapter 21, “Endangered Plants,” establishes an endangered plant species list and rules for collection. There is no known threatened or endangered species on the Site at this time.

1.4.4.12 *Transportation and Highway*

NMAC Title 18, Chapter 31, Part 6, “State Highway Access Management Requirements,” establishes state highway access management requirements that will protect the functional integrity of and investment in, the state highway system.

1.4.4.13 *State Trust Lands Land Exchanges*

NMAC Title 19, Chapter 2, Part 21, “Land Exchanges,” establishes State standards and procedures for exchanges of lands held in trust, including consideration of cultural and natural resources and wildlife.

1.4.4.14 *New Mexico Cultural Properties Act*

NMSA, Chapter 18, Libraries and Museums, Article 6, “Cultural Properties,” establishes the SHPO and requirements to prepare an archaeological and historic survey and consult with SHPO. The cultural resource inventory has been completed. The survey for cultural resources consisted of a file search, field inventory, and inventory report.

1.4.4.15 *Registration of Tanks*

NMAC, Title 20, Chapter 5, Part 2, “Registration of Tanks,” establishes the state standards for the regulation of petroleum storage tanks. If needed, such storage tanks will be designed in accordance with state requirements and registration application made.

1.4.4.16 *New Mexico Night Sky Protection Act*

NMSA Chapter 74, Article 12, “Night Sky Protection,” establishes requirements to preserve and enhance the state’s dark sky while promoting safety, conserving energy and preserving the environment for astronomy. These requirements will be addressed during detailed design of the facility.

1.4.4.17 New Mexico Occupational Safety and Health

NMSA, Chapter 50, Sections 1-25, and implementing regulations at NMAC Title 11, “Labor Workers Compensation,” Chapter 5, “Occupational Safety and Health” establishes state requirements for assuring safe and healthful working conditions for every employee. These state regulations are being followed to ensure any additional requirements beyond the federal OSHA regulations are adequately addressed.

1.4.4.18 *Environmental Improvement Act - Drinking Water Regulations*

NMSA 1978, Sections 74 1-8 and 74 1-13.1 require the establishment of drinking water standards for New Mexico. These regulations are found at 20.7.10 NMAC. The proposed facilities use on site groundwater supplies. Under the New Mexico drinking water regulations at Title 20 Chapter 7, the facility would be classified as a non-transient, non-community water supply system because it regularly serves greater than 25 people.

1.4.5 Involved State Agencies

NMED is charged with responsibility to manage and protect human health and the environment in the State of New Mexico. The NMED consists of several divisions that have responsibility for various permits and environmental programs. The general and specific NMED permits and permit requirements are discussed below under the NMED Bureau that has responsibility for reviewing and approving the permitting action.

1.4.5.1 New Mexico Air Quality Bureau

For the New Mexico Air Quality Bureau (NMED/AQB), the AQB Permitting Section processes permit applications for industries that emit pollutants to the air. The Permitting Section consists of two groups: New Source Review and Title V. New Source Review (NSR) is responsible for issuing Construction Permits, Technical and Administrative Revisions or Modifications to existing permits, Notices of Intent (NOI) for smaller industrial operations, and No Permit Required (NPR) determinations. The two types of Permits issued for larger industrial facilities are as follows (NMAC, 2002a):

- Construction Permits are required for any person constructing a stationary source which has a potential emission rate greater than 10 lb/hour or 25 tons per year of any regulated air contaminant for which there is a National or New Mexico Ambient Air Quality Standard. If the specified threshold is exceeded for any one regulated air contaminant, all regulated air contaminants with National or New Mexico Ambient Air Quality Standards emitted are subject to permit review. Within this regulation, the potential emission rate for nitrogen dioxide is based on total oxides of nitrogen; all sources with the potential emission rate greater than 10 lb/hour, or 25 tons/year, of criteria pollutants (such as nitrogen oxides and carbon monoxide). Air quality permits must be obtained for new or modified sources.
- Operating Permits (under Title V) are required for major sources that have a potential to emit more than 100 tons/year for criteria pollutants. In addition, major sources also include facilities that have the potential to emit greater than 10 tons/year of a single Hazardous Air Pollutant, or 25 tons/year of any combination of Hazardous Air Pollutants. Generally, mobile sources are not required to obtain an operating permit from AQB; however, there are provisions for inspection and maintenance of mobile sources in certain non-attainment areas. Lea County, New Mexico, is not located in a non-attainment area.

1.4.5.2 New Mexico Water Quality Bureau

Within the New Mexico Environment Department/Water Quality Bureau (NMED/WQB), the NPDES General Permit for Industrial Storm water is required for point source discharge of storm water runoff from industrial or commercial facilities to the waters of the state. All new and existing point source industrial storm water discharges associated with industrial activity require NPDES Storm Water Permits from the EPA Region 6 and an oversight review by the NMED/WQB. The facility may be eligible to claim the “No Exposure” exclusion for industrial activity of the NPDES Storm water Phase II regulations. As such, the owner would submit a No Exposure Certification immediately prior to initiating operational activities at the Site. The owner also has the option of filing for coverage under the Multi-Section General Permit (MSGP). If this option is chosen, the owner then files a Notice of Intent (NOI) with the EPA at least two days prior to the initiation of operations. There is also an option to obtain an individual NPDES permit. The facility may be required to obtain this type of permit based on facility final design. A decision regarding which option is appropriate for the IIFP facility will be made in the future based on detailed design engineering.

An NPDES General Permit for Construction Storm water likely will be required. Construction of the facility will involve the grubbing, clearing, grading or excavation of more than 1 acre of land coverage. It will require application for the NPDES Construction Storm water General Permit from the EPA Region 6 and an oversight review by the New Mexico Water Quality Bureau. Various land clearing activities such as off-site borrow pits for fill material may also be covered under this general permit. IIFP will also develop a SWPPP and file a NOI with the EPA at least two days prior to the commencement of construction activities.

The New Mexico Water Quality Bureau requires that the facilities that discharge an aggregate waste of more than 2,000 gallons per day septic systems apply for and submit a groundwater discharge permit and plan. Discharges to surface impoundments, such as retention basins, may also require a groundwater discharge permit. This requirement is based on the assumption that these discharges have the potential of affecting groundwater. The IIFP plant design concept currently includes tertiary treatment for about 3,000-4,500 gallons per day of sanitary waste water followed by reuse of water within the facility or for site landscaping water supply. The design concept also addresses storm water disposition by collecting and evaporating in retention basins. Both of these water sources will have been sampled and the sanitary water will have been tertiary treated. However, a groundwater discharge permit may still be required. Based on experience at two nearby industrial facilities, it is concluded that the facility will be able to secure this permit. The groundwater discharge permit/plan is required under New Mexico Administrative Code (NMAC) 20.6.2.3104 NMAC. Section 20.6.2.3104 NMAC of the New Mexico Water Quality Control Commission Regulations (20.6.2 NMAC) requires that any person proposing to discharge effluent or leachate so that it may move directly or indirectly into groundwater must have an approved discharge permit, unless a specific exemption is provided for in the Regulations. Pursuant to Regulation 20.6.2.3108 NMAC, NMED will, within 30 days of deeming the application administratively complete, publish a public notice and allow 30 days for public comment before taking final action on a discharge permit. Following completion of the public notice process, the NMED will issue a draft permit for review and comment. A public hearing will be held if NMED determines that there is significant public interest. It takes approximately 180 days to process a complete application and issue a discharge permit if no public hearing is held.

An Aquatic Resource Alteration Permit (ARAP/Section 401 Certification) is for activities that involve physically altering waters (streams and wetlands) of the State, including water withdrawals that have the potential to significantly degrade the water quality in the stream. Persons who conduct any activity that involves the alteration of waters of the State require a state and possibly a federal permit. Federal permits

are required for projects involving the discharge of dredged or fill material into waters of the U.S. or wetlands. Aquatic Resource Alteration Permits (ARAP) would be required for any alteration of state waters, including wetlands that do not require a federal permit. Under Section 401 of the federal Clean Water Act, States can review and approve, condition, or deny all federal permits or licenses that might result in a discharge to state waters, including wetlands. A 401 certification confirms compliance with the state water quality standards. Activities that require a 401 certification include Section 404 permits issued by the USACE. The State of New Mexico has a cooperative agreement and joint application process with the USACE relating to 404 permits and 401 certifications. No Corps of Engineers jurisdictional wetlands at this time have been identified on the Site.

1.4.5.3 New Mexico Hazardous Waste Bureau

The New Mexico Environment Department/Hazardous Waste Bureau (NMED/HWB) mission is to provide regulatory oversight and technical guidance to New Mexico hazardous waste generators and treatment, storage, and disposal facilities as required by the New Mexico Hazardous Waste Act [HWA; Chapter 74, Article 4, NMSA 1978] and regulations promulgated under the Act. In general, the regulations promulgated pursuant to the *Hazardous Waste Act* incorporate the federal requirements under the RCRA, 40 CFR 260-283, by reference. The bureau issues hazardous waste permits for all phases, quantities and degrees of hazardous waste management including treating, storing and disposing of listed or hazardous materials.

Hazardous Waste Permits are required for the treating, storing or disposing of hazardous wastes. Source, special nuclear or by-product material as defined by the Atomic Energy Act is specifically excluded from the definition of a solid waste and therefore cannot be a hazardous waste regulated under the RCRA. Any person owning or operating a new or existing facility that treats, stores, or disposes of a hazardous waste must obtain a hazardous waste permit from the New Mexico Hazardous Waste Bureau.

1.4.5.4 New Mexico State Land Office

A Right-of-Entry Permit is required to access state land. Surface Resources section of the New Mexico State Land Office (NMSLO) administers renewable resources and sustainable activities on state trust land and works to enhance environmental quality of the lands. Also, it manages the biological, archeological, and paleontological resources. Surface Resources administers agriculture leases, rights of way, and special access permits. It is responsible for mapping, surveying, geographic information systems, and records management. If the Site is not State-owned land, a Right-of-Entry Permit is not required. If State lands are used for background or off-site monitoring locations, a permit is required. IIFP possesses the Right of Entry Permit so NMSLO could conduct environmental surveys on the land prior to the land being transferred, or easement granted to IIFP.

1.4.5.5 New Mexico Department of Game and Fish

Rare, Threatened and Endangered Species Survey permits will be required to conduct site surveys. The New Mexico Department of Game and Fish (NMDGF) mission is to assist all New Mexico wildlife in need. The program funds four general categories: research, public education, habitat protection, and wildlife rehabilitation, including rare threatened and endangered species. Permits will be obtained to conduct rare, threatened and endangered (TRE) surveys for both plants and animals, in accordance with the timeframe requirements prior to construction.

1.4.5.6 New Mexico Energy, Minerals and Natural Resources Department

The mission of the Forestry Division within New Mexico Environment Department/Energy, Minerals and Natural Resources Department (NMED/EMNRD) includes the protection of endangered plant species. The program describes the rules and permitting requirements during scientific investigations and collection activities. No threatened or endangered species are thought to be present on the proposed Site.

1.4.5.7 New Mexico Radiological Control Bureau

Radiation machine is defined by the New Mexico Radiation Protection Regulations (NMRPR) as any device capable of producing radiation except those which produce radiation only from radioactive material. The bureau regulates radiation machines used for non-destructive testing and their usage in accordance with the requirements of the NMRPR (20.3 NMAC) (NMAC, 2001a). Registrants are required to maintain hardcopies of pertinent parts of the regulations. Mandatory parts include 20.3.2, 20.3.4 (except appendices), and 20.3.10. Other parts apply, as applicable, for the type of use. The facility may periodically use non-destructive (x-ray) inspection systems for welding inspections. If the output at 1 foot from the unit exceeds 0.5 mR/hr, then the x-ray unit will be registered with the State Radiological Control Bureau under NMAC 20.3.11.

1.4.5.8 New Mexico State Historic Preservation Office

Cultural properties, including prehistoric and historic archaeological sites, historic buildings and other structures, and traditional cultural properties located on state land in New Mexico are protected by the Cultural Properties Act. It is unlawful for any person to excavate, injure, destroy, or remove any cultural property or artifact on state land without a permit. It is also unlawful for any person to intentionally excavate any unmarked human burial, and any material object or artifact interred with the remains, located on any non-federal or non-Indian land in New Mexico without a permit. Any cultural sites that are eligible for listing on the National Registry of Historic Places will be avoided or data recovery will be performed. These efforts would be coordinated with the New Mexico State Historic Preservation Office (SHPO). IIFP through the Economic Development Corporation of Lea County arranged for a subcontractor to obtain a permit and performed an archaeological survey. See ER Section 3.8.2, "Archeological or Historic Surveys," for complete details of the survey.

1.4.5.9 New Mexico Office of the State Engineer

Groundwater monitoring wells are permitted through Office of the State Engineer (OSE) and well locations along with the boring logs are submitted to the OSE. Monitoring wells are likely to be required at yet-to-be-determined locations in selected site areas. Future detailed engineering and hydrological studies will identify the appropriate systems and locations.

1.4.6 Support from Local Agencies

Historically, Lea County has supported nuclear industries coming to the area, as evidence in the extensive public meetings held to fulfill the requirements for the National Enrichment Facility (NEF) licensure and for consideration of the Global Nuclear Energy Partners (GNEP) projects (EDCLC, 2008). Current local and state officials support IIFP Facility coming to Lea County as evidenced by the letters found in the Appendix B and the written agreement with NMED on chemical inventories.

The purpose and objectives of this site evaluation have been communicated and coordinated to-date with local organizations. Officials in Lea and Eddy County area have been contacted for pertinent information

to support this preliminary assessment. Emergency support services for the proposed facilities at the Site would be coordinated at the appropriate time with state and local agencies. Those services would include central dispatch points of contact for fire, Emergency Medical Services (EMS) and the local law enforcement personnel. Mutual aid inter-agreements exist between local police departments, county sheriff departments, and the New Mexico State Police, which are activated if additional police support is needed. Mutual aid agreements also exist for additional fire and medical services.

A Memorandum of Understanding (MOU) will be developed between IIFP and police, fire and medical emergency service organizations before construction begins at the Facility. The local and State emergency services indicate a willingness to develop MOU's with IIFP as evidenced by the letters in ER Appendix B and in the IIFP License Application, Chapter 8, "Emergency Management." Signees would include local police departments, local sheriff offices, and the New Mexico Department of Public Safety, which includes both the New Mexico State Police and the New Mexico Office of Homeland Security and Emergency Management.

Local emergency responders and medical facilities are well prepared and trained to respond to releases of radioactive materials and contaminated personnel. Routine emergency response drills and specialized training have been conducted by the Department of Energy (DOE) for local personnel as well as emergency responders along the major transportation corridors to and from the Lea and Eddy County areas as a contingency for any transuranic (TRU) waste incidents related to any shipment to the Waste Isolation Pilot Plant (WIPP) facility (DOE, 1997a). MOUs have also been signed between Louisiana Energy Systems with Eunice, Hobbs, Lea County, and New Mexico organizations for fire and medical emergency services for the NEF (LES, 2004).

1.4.7 Surveys Conducted

A Phase 1 Environmental Site Assessment (ESA) has been conducted by BBC International, Inc. (BBC) of the property located in Township 18 South, Range 36 East near Hobbs, New Mexico (BBCI, 2009). The purpose of the ESA was to permit IIFP to satisfy one of the requirements to qualify for the innocent landowner defense, the Comprehensive Environmental Response, Compensation and Liability Act (CERCLA) liability: that is, the practices that constitute "all appropriate inquiries into the previous ownership and uses of the property consistent with good commercial or customary practice" as defined in 42 USC 9601 (35) (B). BBC examined the site reviewed and researched available databases of government environmental agencies. The ESA as performed to the American Standard Testing Method (ASTM) E 1527-00, Standard Practice for Environmental Site Assessments: Phase 1 Environmental Assessment Process. The Phase 1 ESA revealed no evidence of soil staining or distressed vegetation. Two above ground storage tanks were observed at the site. There was no evidence of underground storage tanks at the site. There are four high voltage electric power transmission lines crossing the property.

BBC International developed the following list of transmission lines and pipelines crossing the site:

- Xcel Energy high voltage transmission line going northeast across site. See Figure 4-9 in Section 4.9.4, "Significant Visual Impacts."
- Mark West Pinnacle two pipelines going west across site. See Figure 3-67 in Section 3.9.4, "Important Landscape Characteristics."
- DCP Midstream two pipelines going east and west.
- DCP Midstream pipeline junction going north and south. See Figure 4-7 in Section 4.9.3, Aesthetic and Scenic Quality Rating.
- DCP Midstream third pipeline going north and south.
- DCP Midstream fourth pipeline going east and west across site.

- DCP Midstream fifth pipeline going east and west across site.
- Chaparral Pipeline/Teppco first pipeline going east and west.
- Chaparral Pipeline/Teppco second pipeline going east and west.
- Plains Pipeline LP pipeline going east and west across site.
- Dynegy Midstream Services LP pipeline going east and west.
- PNM Gas Service pipeline going northeast and southwest. See Figure 4-9 in ER Section 4.9.4, “Significant Visual Impacts.”
- Unmarked pipeline row going southeast to northwest through center of site. See Figure 3-66 in ER Section 3.9.4, “Important Landscape Characteristics.”

Other structures or miscellaneous facilities of the site identified by BBC International include the following:

- Duke Energy pipeline facility in approximate center of site. See Figure 3-68 in ER Section 3.9.4, “Important Landscape Characteristics.”
- Power Tex and PNM Gas Service pipeline facility in approximate center. See Figure 3-69 in ER Section 3.9.4, “Important Landscape Characteristics.”
- PNM Gas Service pipeline facility in approximate center of site. See Figure 4-14 in ER Section 4.9.4.1, “Physical Facilities Out of Character with Existing Features.”
- Caliche road in approximate center leading to a caliche pit. See Figures 4-11 and 4-12 in ER Section 4.9.4, Significant Visual Impacts.
- DCP Midstream fluid collection Tank at the center of the west side. See Figure 4-13 in ER Section 4.9.3, Significant Visual Impacts.
- Teppco pipeline clean-out trap in approximate center of the west side.
- Groundwater monitoring well monitored by Xcel Energy in the northwest corner of site.

Various government agency databases were reviewed to determine the regulatory status of the site and adjacent properties within one mile and to identify any record of violations or concerns of an environmental nature. Below are the databases reviewed by BBC International and the results of those reviews:

- Underground storage tanks (UST) List: No USTs were registered at the site and no UST sites were within the 0.15 mile radius of the search.
- Leaking underground storage tanks (LUST) List: The LUST consist of UST systems which have had releases reported of greater than 25 gallons of petroleum products. No LUST sites are located with 0.5 mile of the site.
- NMED solid waste database: The NMED Solid Waste Bureau maintains a database indicating the presence of landfills that are currently open or have been closed. The site, adjacent properties, and properties within 0.5 mile of the site were not listed on the NMED database summary.
- Emergency Response Notification System List: This database is maintained by the USEPA which records sites where spills of hazardous materials have occurred. The site and adjacent properties did not appear on the list.
- The National Priorities List (NPL): Database compiled by the USEPA and identifies sites which have been designated as Superfund sites or are being considered for Superfund status. The site, adjacent properties, and properties within one mile of the site did not appear on the NPL.
- CERCLA List (Active): The Comprehensive Environmental Response and Liability Information System (CDRCLIS) List compiled by the federal government and includes sites which could possibly be contaminated and may require cleanup. No properties with 0.5 mile of the site appeared on the list.

- Treatment, Storage, and Disposal (TSD) List: This database is compiled by the USEPA and records RCRA sites permitted for treatment, storage and disposal of hazardous materials. The site and adjacent properties did not appear on the TSD List.
- RCRA Notifiers List: This list specifies all sites within 0.15 mile of the site which have been registered as large or small generators of hazardous waste. No properties appeared on the RCRA Notifiers List.

Other pertinent findings of the ESA are as follows:

- Review of historical aerial photographs did not review any obvious environmental concerns.
- No structures and no suspected asbestos containing materials (ACM) were observed on the site.
- No lead contamination or potential lead contamination was observed at the site.
- The city of Hobbs and Lea County shows slight traces of radon according to the EPA radon survey. It is not considered a hazard due to the low percentages found.
- A review of the title search revealed numerous right-of-ways. See Figure 1-6, Easements on IIFP Site.
- Additionally, a cultural resource survey was conducted on the site. Three isolated occurrences were encountered during the survey. The isolated occurrences have been completely recorded in a manner consistent with current standards and do not require any additional work. See ER Section 3.8.2, "Archaeological or Historic Surveys," for complete details of the survey.

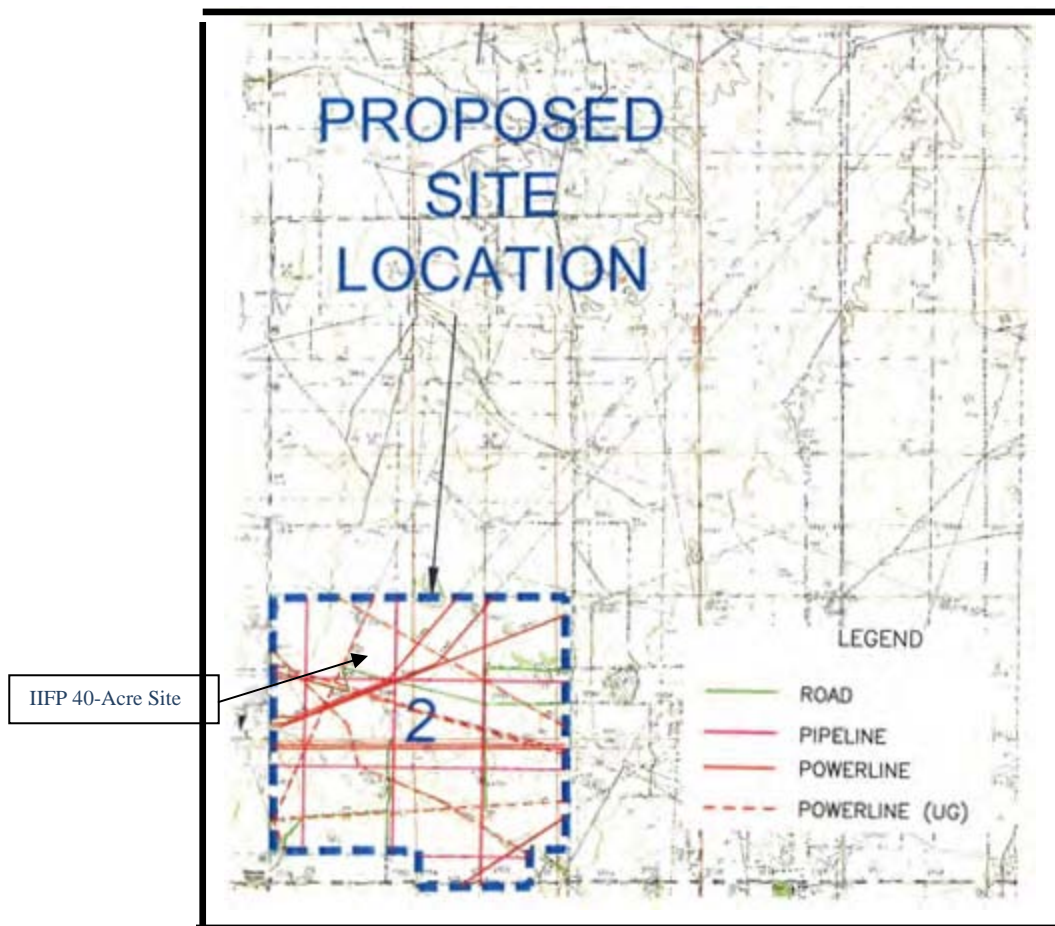

Figure 1- 6 Easements on IIFP Site

1.5 Building Permits and Licenses

Building Permits for foundations, structures, electrical and mechanical systems will be required from New Mexico Regulation and Licensing/Construction Industries Division (NMRL/CID). These permits are required for temporary construction-related structures, such as office trailers, and all permanent structures. Site security fencing will also require a permit from NMRL/CID. There are no known local or county zoning issues that should preclude use of the site. Codes and standards that will be used for the plant design basis engineering including those provided in Section 1.3.2.2 “Design Basis Standards and Codes.”

A number of licenses and permits will be required for construction and operation of the IIFP plant. A summary of licenses and permits that are currently known to be required are listed in the Table 1-4. During the federal and State permitting process, any changes in requirements will be re-evaluated.

Table 1- 4 Required Federal and State Permits

Potential Requirement	Agency	Comment/Status	Projected Time Frame
<i>Federal</i> 10 CFR Part 40,	NRC	The proposed IIFP license application is being submitted.	End of 2009
NPDES General Permit For Industrial Stormwater	EPA Region 6 ^a	IIFP will file for coverage under the Multi-Sector General Permit.	2 nd Qtr 2010
10 CFR Part 70, 10 CFR Part 40, 10 CFR Part 30	NRC	The proposed IIFP license application is being submitted.	End of 2009
NPDES Construction Stormwater General Permit	EPA Region 6/NMED	IIFP will file for coverage under the General Construction Permit for construction activities on site. IIFP will develop a Stormwater Pollution Prevention Plan and file a Notice of Intent.	2 nd Qtr 2010
<i>State</i> Access Permit	NMDOT	IIFP and/or Lea County would coordinate to obtain approval, if necessary, for adding an entry point from U. S. 62/180 or NM 483. The permit, if issued, would stipulate any safety enhancements necessary to the highway.	2 nd Qtr 2010
Air Construction Permit	NMED/AQB	An air construction permit may not be required because proposed IIFP emissions would be below Federal and State regulatory limits depending on credits for stack heights and control equipment. Need determination with State.	If required, submit by 2 nd Qtr 2010.
Air Operation Permit	NMED/AQB	An air operation permit may not be required because proposed IIFP emissions would be below the Federal and State regulatory limits depending on above credits. Need determination with State.	If required, would submit 2 nd Qtr 2011.
NESHAP Permit	NMED/AQB	A NESHAP permit is likely not required because the proposed IIFP emissions would be below Federal and State regulatory limits. Need to determine with State.	If required, submit by 3 rd Qtr, 2011.
Groundwater Discharge Permit/Plan	NMED/WQB	IIFP will submit Groundwater Discharge Permit / Plan application to the NMED/WQB.	3rd Qtr 2010

Potential Requirement	Agency	Comment/Status	Projected Time Frame
NPDES Industrial Stormwater	NMED/WQB	IIFP has the option of claiming No Exposure” exclusion.	Make determination by 3 rd Qtr 2010. If required, submit by 1 st Qtr 2011.
NPDES Construction Stormwater Permit	NMED/WQB	IIFP will file for coverage under the General Construction Permit for construction activities on site. IIFP will develop a Stormwater Pollution Prevention Plan and file a Notice of Intent.	2 nd Qtr 2010
Hazardous Waste Permit	NMED/HWB	IIFP would be classified as a generator; therefore, a hazardous waste permit would be required.	3 rd Qtr 2011
EPA Waste Activity EPA ID Number	NMED/HWB	This number is required for the storage and use of hazardous chemicals.	3 rd Qtr 2011
Machine-Produced Machine-Produced(X-Ray Inspection)	NMED/RCB	Registration is required for security nondestructive inspection (x-ray) machines. The RCB will be notified that equipment would be registered, but the registration would be deferred until equipment specifications are available. May be required by contractor with their own permit.	Decide who holds permit by 1 st Qtr 2011.
Rare, Threatened, & Endangered Species Survey Permit	NMDFG	This permit would be required for conducting surveys of the U.S. Bureau of Land Management (BLM) lands.	1 st Quarter 2010
RCRA Operations Permit	EPA May Involve NMED/HWB	Permit likely not required for the EPP operation, but need to confirm with the State.	If required, would submit permit application 4 th Qtr 2011.
Right-of-Entry Permit	NMSLO	IIFP has obtained this permit for entry onto Section 26, 27, 34, or 35.	Completed.
State Land Swap Arrangement	NMSLO	This arrangement requires that an environmental assessment and a cultural resources survey be conducted on lands offered for exchange..	Both surveys have been completed
Class III Cultural Survey Permit	NMSHPO	IIFP has obtained this permit to conduct surveys on Section 26, 27, 34, or 35.	Completed

NPDES – National Pollutant Discharge Elimination System; EPA – U.S. Environmental Protection Agency; NESHAP – National Emissions Standards for Hazardous Air Pollutants; NMED/WQB – New Mexico Department of Transportation; NMED/AQB – New Mexico Environment Department /Air Quality Bureau; NMED/HWB – New Mexico Environment Department/Hazardous Waste Bureau; NMED/RCB – New Mexico Environment Department/Radiological Control Bureau; NMED/WQB – New Mexico Environment Department/Water Quality Bureau; NMDGF – New Mexico Department of Game and Fish; NMSLO – New Mexico State Land Office; NMSHPO – New Mexico State Historic Preservation Office.

2 ALTERNATIVES

The first part of this Chapter 2 further discusses the Proposed Action, including the process, facility infrastructure descriptions and decommissioning. The latter part of the Chapter focuses on evaluation of the Alternatives. The Chapter considers the potential environmental impacts associated with a No-Action Alternative and Reasonable Alternatives as compared to the Proposed Action. The purpose and need of the Proposed Action, schedules, description of the site location, facility design capacities and proposed material possession license limits and chemical inventories have all been described in the IIFP Environmental Report (ER) Chapter 1.

2.1 Proposed Action

Gaseous uranium hexafluoride (UF_6) is produced commercially as the feed material for isotopic enrichment of uranium in existing and planned commercial plants. The enriched UF_6 is processed further for use in fuel rods of nuclear reactors for generating electrical power. Uranium hexafluoride is the normal assay feed for all of the existing uranium enrichment commercial plants; gaseous diffusion and centrifuge processes. It will also be the feed material used in the planned laser-based enrichment plant; the SILEX process currently under Nuclear Regulatory Commission license review. As a result of the enrichment processes, DUF_6 remains as a by-product (tails). The tails cannot be disposed in the chemical form of UF_6 owing to its increased hazard. There is currently no facility in the U.S. for converting the tails into a form suitable for disposal.

Large quantities of DUF_6 have been stored in its solid state in cylinders at the Department of Energy (DOE) enrichment sites for many years. In recent years, the U.S. government decided to render the stored DUF_6 into stable oxide form for disposal. The Department of Energy is now constructing their own plants to de-convert their large stockpile of DUF_6 to oxides. The DOE stockpiles and backlog of tails for de-conversion were generated by DOE, prior to the privatization of uranium enrichment.

DUF_6 continually will be generated at existing and planned commercial uranium enrichment plants. Additional commercial uranium enrichment plants currently being built or planned in the U.S. will result in generation of increasingly large volumes of DUF_6 . One new commercial uranium enrichment plant is built and scheduled to start up within the next year. One other is licensed and under construction, and two others are in the engineering and licensing review stages. Large amounts of tails material from those facilities will ultimately need de-conversion for stable disposal. The IIFP Proposed Action will serve part of that need by providing a commercial de-conversion capability at the IIFP facility near Hobbs, NM.

IIFP is proposing to design, engineer and license what is likely to be the nation's first privately-owned commercial facility for de-conversion of DUF_6 . As described in Chapter 1, the facility is proposed to be built in two phases.

Phase 1, with a projected startup date of late 2012, consists mainly of two processes:

- DUF_6 de-conversion to depleted uranium tetrafluoride (DUF_4), i.e. the DUF_6 to DUF_4 plant.
- The Fluorine Extraction Process for producing SiF_4 and BF_3 by reacting the DUF_4 produced in the de-conversion step with the oxides of silicon (SiO_2) and boron (B_2O_3), respectively

The phase 2 plant, scheduled for startup in mid-2016 will have an additional process for direct de-conversion of DUF_6 to uranium oxide.

2.1.1 Proposed Site and Location

The proposed IIFP site Section consists of 259 ha (640-ac), of which approximately 16.2 ha (40-ac) is the facility site proper. The surrounding acres around the approximately 40-acre site primarily serve as an environmental buffer. The site is located 14 miles west of Hobbs, New Mexico on U.S. Highways 62/180 (U.S. 62/180) near the New Mexico/Texas State line in Lea County, New Mexico. See Figure 2-1, Location of Proposed IIFP Site. The site 640-acre Section lies along the north side of U.S. 62/180 and along the east side of New Mexico Highway 483 (NM 483).

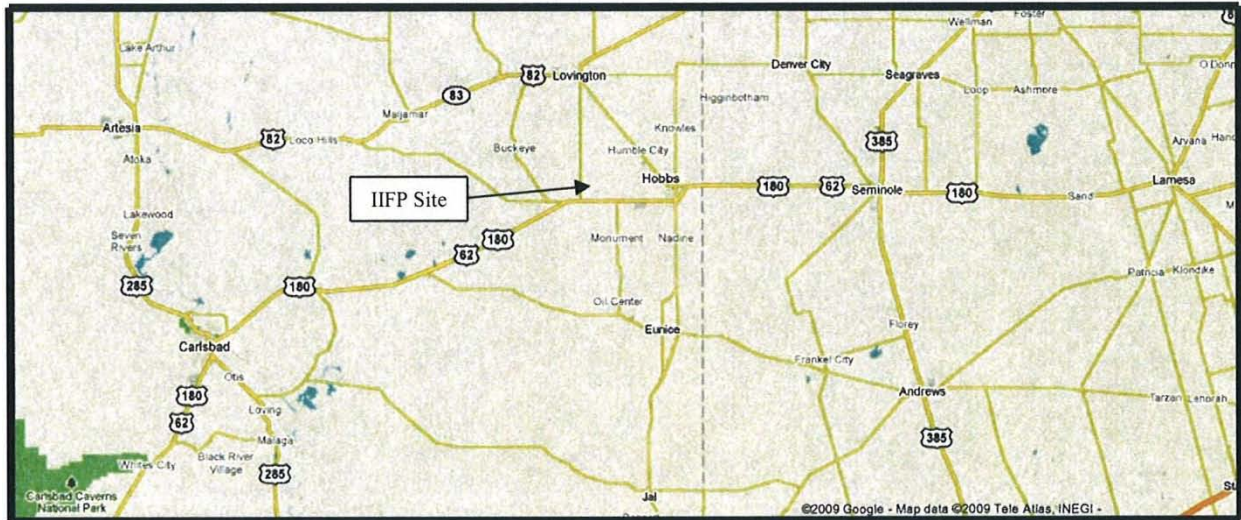

Figure 2- 1 Location of Proposed IIFP Site

The area surrounding the site consists of vacant land and industrial properties. The general area consisting of four (4) approximate 640-acre Sections is delineated in Figure 2-2, “IIFP Site Map with Surrounding Industrial Properties.” The Proposed IIFP Facility will be built on 16.2 ha (40 ac) of one of the 259-ha (640-ac) Sections (Section 27). The approximate 40-acre plot is shown in Figure 2-3. The approximate center of the 40-acre site is latitude 32 degrees, 43 minutes North and 103 degrees 20 minutes West longitude.

The proposed site is located within Township 18S, Range 37E, and Sections 26, 27, 34, and 35. The site is relatively flat with slight undulations in elevation. Surrounding properties consist of vacant land and the industrial Xcel Energy Cunningham Generating Station on the west boundary; Xcel Energy Maddox Generating Station 3 km (2 mi) east of the site; and Colorado Energy Generating Station located 5 km (3 mi) southeast from the center of the site along U.S. 62/180. Several power lines and underground power lines generally run across the proposed site generally east to west, and several gas pipelines run north and south as well as east to west. The proposed IIFP Site as well as land around the proposed site has been mostly developed by the oil and gas industries.

Further description of the site area and the current state of the site is provided in Section 1, Chapter 3 of this ER.

Impacts to the site area are determined to be “Small”, except during full construction when transportation and ecological impacts could be “Moderate” for some specific wildlife travel corridors. Controls are identified in ER Chapter 5 that mitigate the “Moderate” impacts.



Figure 2- 2 IIFP Site Map with Surrounding Industrial Properties.

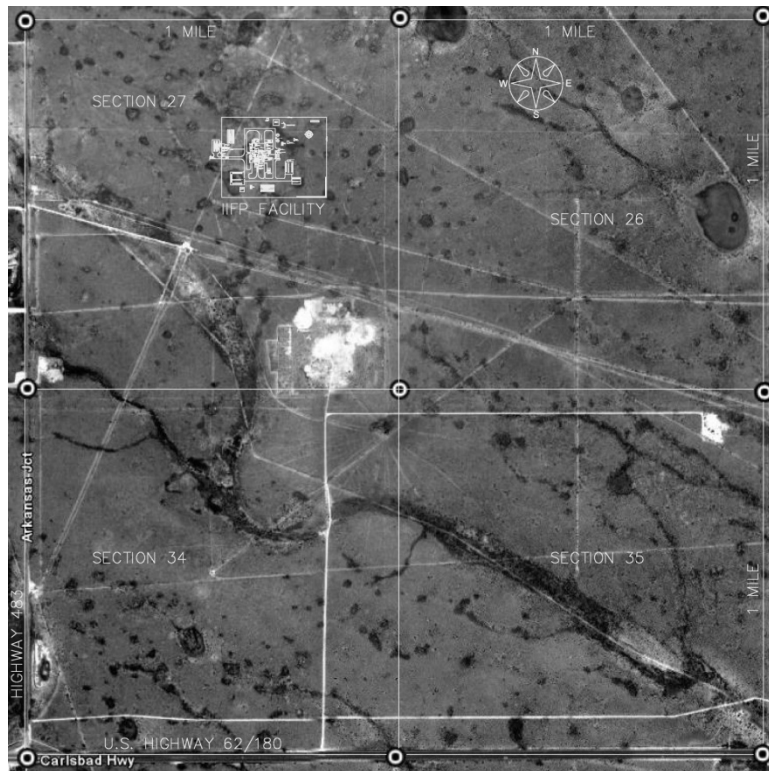

Figure 2- 3 Location of the IIFP Facility within Section 27 of the Proposed Site

2.1.2 Site Construction

The Proposed Action construction and startup schedules are provided in the ER Chapter 1.

IIFP is proposing to request an exemption from NRC to conduct some pre-license preparatory type construction activities. The pre-licensing construction proposes activities only affect the timing of work and will not increase the scope or environmental impact of facility construction. Potential pre-licensing construction activities may include the following:

- Clearing land,
- Site grading and erosion control,
- Installing main entrance roadbed and drainage to highway,
- Installing construction trailer,
- Preparing preliminary site roadways and gravel parking area,
- Potential drilling of water wells,
- Constructing power substation,
- Stubbing in gas line to the meter,
- Beginning administration building construction,
- Beginning warehouse building construction,
- Installing geothermal heating/cooling loops, and
- Installing firewater tanks.

Throughout this ER, where applicable, pre-license construction is considered in evaluating the environmental impacts and is determined to have a “SMALL” impact in each of the impact areas evaluated.

Construction will occur in three phases. The first phase will involve certain pre-licensing construction tasks based on NRC approval of the exemption request. The activities will be preparatory in nature and will not involve any process or safety related equipment or systems. A Spill Prevention Control Countermeasures Plan and an NPDES Construction Stormwater Permit with the General Construction Permit will be completed prior to the implementation of pre-license construction activities.

After NRC approval of the license, general construction will begin and any unfinished pre-licensing construction activities, including buildings, completion of roads and pads, and installation of systems and equipment, will be completed for the Phase 1 facility. The third construction phase is expected to begin in 2015 and will complete the Phase 2 facility to add additional DUF₆ de-conversion capacity.

The Hobbs, New Mexico site characteristics are such that it will not likely need major earth grading or movement. Excavation is required for sewer systems, roads, pads, building foundations and floors, etc.

During the construction phases of the IIFP Site, conventional earthmoving and grading equipment will be used. The removal of very dense soil (caliche) may require the use of heavy equipment with ripping tools. Soil removal work for foundations will be controlled to minimize excavation. In addition, loose soil and/or damaged caliche will be removed prior to installation of foundations for seismically designed structures. Less than 10% of the total 640-Section area will be disturbed.

The IIFP facility will require the installation of water, natural gas, and electrical utility lines. It is expected that some of these utilities will be installed during the pre-licensing construction period.

On-site wells will be utilized to supply potable water, process makeup water, and fire water. The site is over the Ogallala Aquifer. There are several existing wells on the site that will be investigated for use in lieu of installing new wells.

The natural gas line feeding the site will connect to an existing, nearby line. This will minimize impacts of short-term disturbances related to the placement of the tie-in line.

A new electrical transmission line is proposed for providing electrical service to the IIFP facility. There are currently 115 and 230 kV transmission lines along U.S. Highway 62/180 (U.S. 62/180) and New Mexico Highway 483 (NM 483). In conjunction with the new electrical lines serving the site, the local electrical utility company will install an independent substation to ensure service.

2.1.3 Process Description of the Proposed Action

A description of the IIFP Facility location and site and a general description of the plant processes employed to carry out the Proposed Action are provided in the IIFP Environmental Report (ER) Chapter 1. A more detailed description of the facility processes is presented in the following sections. The following sections explain the de-conversion process and how the fluorine contained in the DUF_6 is extracted and utilized in the production and commercial sale of AHF and valuable fluoride products.

2.1.3.1 Process Chemistry

The IIFP integrated commercial plant involves the following major chemical stoichiometry reactions:

DUF₆ to DUF₄ Process

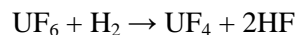

SiF₄ Process



BF₃ Process



DUF₆ De-conversion to Oxide (Phase 2 Plant) Process

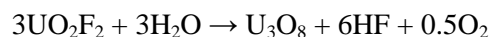
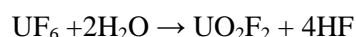

Air and Water Treatment Systems

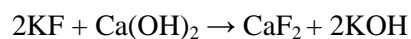
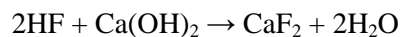
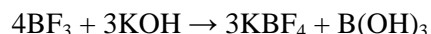
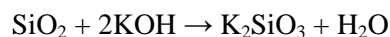
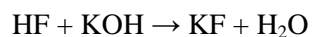
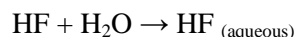

2.1.3.2 De-conversion of DUF₆ to DUF₄

DUF₆ can be converted to DUF₄ by a high temperature reaction with hydrogen. The basic chemical equation is:



The DUF₄ is used as a feed material to produce high-purity fluoride products of SiF₄ and BF₃

The IIFP facility near Hobbs, New Mexico receives DUF₆ material in a solid physical state and typically contained in 14-ton cylinders. The cylinders received are owned by the supplier (the IIFP de-conversion customer) of the DUF₆ and are built by requirement to American National Standards Institute (ANSI) standards (ANSI, 2001). The DUF₆ suppliers (customer) have approval though their NRC license to use the type 48-Y or may have approval for type 48-G cylinder design for containing DUF₆. Cylinders shipped to the IIFP plant are transported by truck trailers that are Department of Transportation (DOT) approved. The 48-Y cylinder is approved for multi-shipments, provided it meets the ANSI mechanical integrity and inspection requirements during its use. If cylinders are used for multi-shipments to IIFP and returns, the supplier/customer retains ownership of the cylinders.

The type 48-G cylinders may require a DOT exemption for over-the-road shipment. The type 48-G cylinders have been shipped in the past by the Department of Energy, but typically it has been used in the industry as an on-site storage cylinder for DUF₆. If a customer were to contract for shipments of DUF₆ to the IIFP facility using type 48-G cylinders, the arrangement would require completely emptying the cylinder into the IIFP process and providing for final disposition of the empty cylinder. One potential means of disposing of the empty cylinder is to use it as a waste container for uranium oxide that is sent to the licensed disposal facility.

The DUF₆ cylinder is placed in a containment-type autoclave; where the contents are vaporized. The DUF₆ vapor is fed to a reaction vessel where it undergoes exothermic reaction to produce DUF₄ and AHF. The DUF₄ solid powder is continuously withdrawn from the reaction vessel bottom through a cooling screw mechanism and transferred to storage hoppers. A 2-stage dust collector system is provided to control and recycle DUF₄ dusts that are internal to the solids handling equipment and generated by air or gas flows associated with the handling equipment. The DUF₄ in the storage hoppers is transferred to the FEP plant for use as raw material feed in producing SiF₄ and BF₃.

Off-gases from the reaction vessel leave the cooling screw equipment and pass through a series of filters and carbon-bed traps to remove entrained particulates and residual traces of un-reacted DUF₆, respectively. The off-gas flow exiting the carbon-bed trap system passes through heat exchangers where the by-product AHF is condensed. Residual off-gases exit the condenser equipment to a hydrogen burner system to remove or combust any un-reacted hydrogen gas followed by a 3-stage scrubbing system designed for removing trace quantities of fluorides. Off-gas flow through the plant scrubbing system is described in Section 2.1.3.6.

The AHF that liquefies in the condenser equipment is drained to storage tanks that are located in a containment-type building. The AHF product is chemically separated from licensed material and physically stored in a building separate from licensed material. The AHF is temporarily stored and then loaded into tank-truck trailers inside the containment-type building for shipment to customers. The trailers are Department of Transportation (DOT) approved for shipment.

Major flows for the process are shown in Figure 2-4.

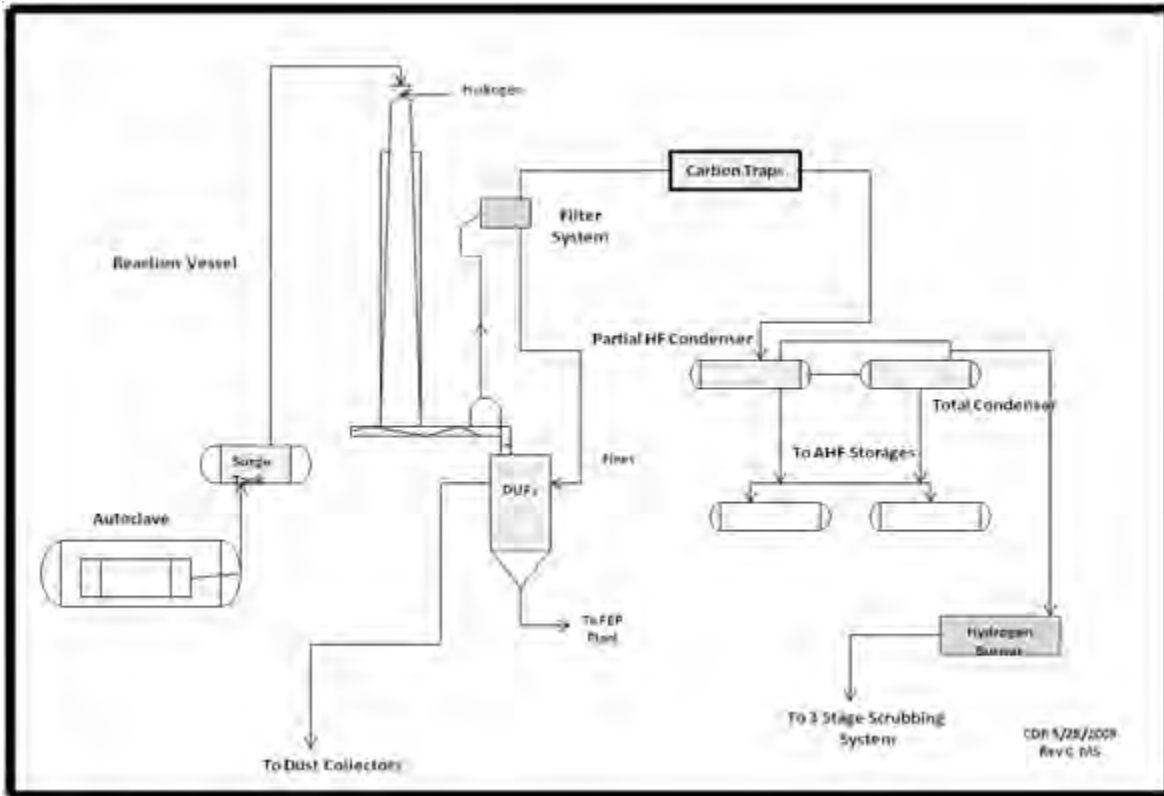
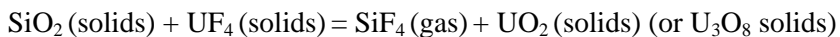

Figure 2- 4 DUF₆ to DUF₄ Plant Major Flows

2.1.3.3 SiF₄ Production

The IIFP method of SiF₄ production in the FEP/DUP plant involves the reaction of solid particulate uranium tetrafluoride (UF₄) with solid particulate silicon dioxide (SiO₂) as follows:



In the production of SiF₄, using the IIFP patented FEP process, silicon dioxide (SiO₂) powder is mixed with DUF₄ and continuously fed to a rotary calciner where the mixture is heated and reacted to form SiF₄ and uranium oxide. The mass flow of the feed mixture is controlled through the rotary calciner to ensure the desired reaction residence time. The resulting SiF₄ gas product and trace impurities exit the rotary calciner as an off-gas while the uranium oxide powder discharges at the end of the rotary calciner through a cooling screw mechanism and transfers to storage hoppers. A two-stage dust collector system is provided to control and recycle uranium oxide dusts that are internal to the solids handling equipment and generated by air or gas flows associated with the handling equipment. The uranium oxide in the storage hoppers is packaged into DOT approved shipping containers and transported to an off-site licensed disposal facility.

Off-gas leaves the rotary calciner and flows through two-stages of filters to capture entrained particulates. Particles captured by the filter system are recycled back as feed to the rotary calciner. After exiting the filter system, the off-gas flow passes through a pre-condenser system to remove HF and other trace gas contaminants; followed by a two-stage cold trap system that collects the SiF₄ product.

The SiF₄ product is collected by solidifying the gas in the cold trap system. More than one cold trap is utilized for operating in a loading and unloading cycle. When a trap is loaded, the coolant temperature is set to allow the product to warm and transfer to a storage vessel. The SiF₄ product is chemically separated from licensed material and physically stored in a building separate from licensed material. The product is packaged as a gas from the storage vessel, using a compressor, into customer cylinders or tube trailers that are a type design approved by the Department of Transportation (DOT).

The final residual off-gas, which is not collected in the cold trap and passes through the cold trap system, flows to the 3-stage plant KOH scrubbing system for treatment to remove trace amounts of fluorides before venting to the atmosphere. Off-gas flow through the scrubbing system is described in Section 2.1.3.6.

Figure 2-5 depicts the SiF₄ major process flows.

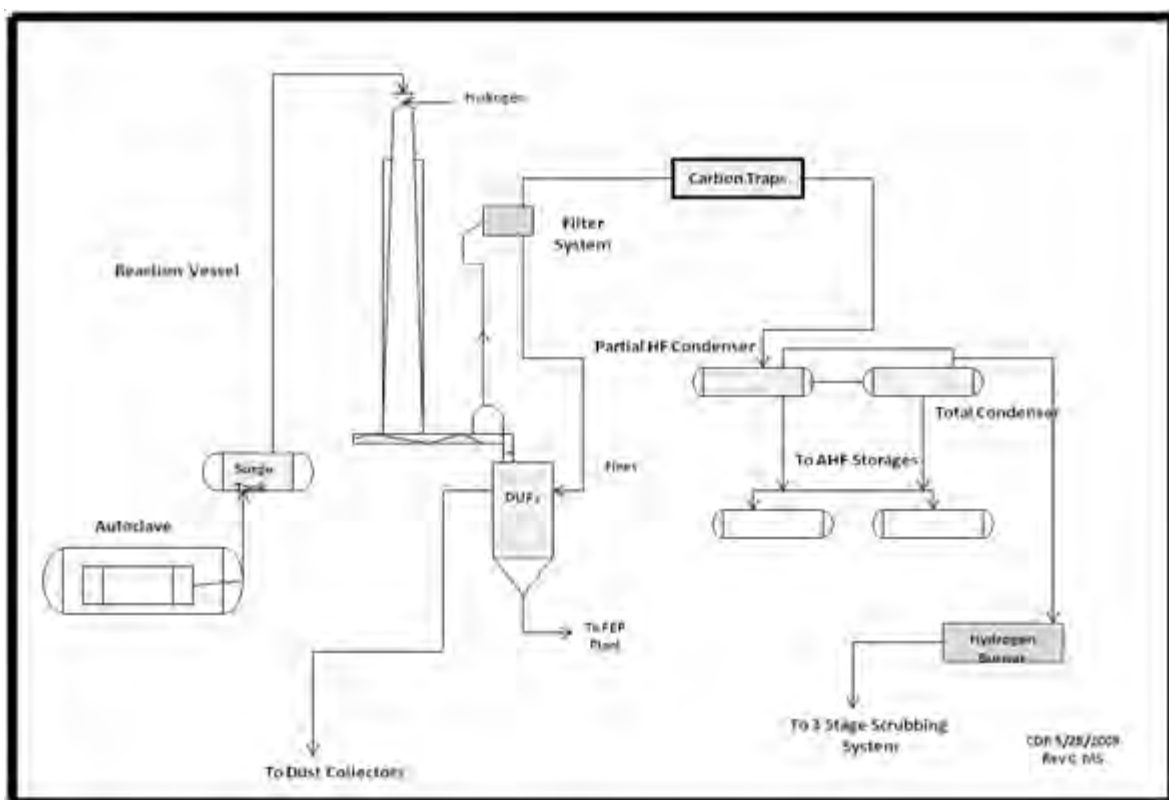

8

Figure 2- 5 SiF₄ Plant Major Flows

2.1.3.4 BF₃ Production

The BF₃ production process follows essentially the same IIFP patented FEP technology as in the SiF₄ process, but involves the reaction of solid particle boric oxide with the DUF₄ as follows:

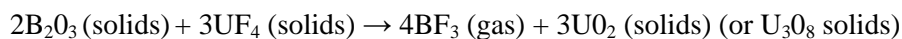

The BF₃ process does include preheating of the feed mixture prior to feeding it to the rotary calciner to remove moisture and minimize the amount of HF impurities in the product gas stream.

In the production of BF_3 , boric oxide (B_2O_3) is mixed with DUF_4 powder and continuously fed to a pre-heater, where the temperature is controlled to cause reaction of small amounts of the DUF_4 with the moisture that may be contained in the mixture. The resulting HF leaves the pre-heater as a vapor and passes through filters and then on to the plant KOH scrubbing system for treatment and conversion to potassium fluoride.

The mixed powder leaves the discharge end of the pre-heater then enters a rotary calciner where it is heated and forms BF_3 gas and uranium oxide powder. The BF_3 product, traces of AHF, and gas contaminants leave the rotary calciner as off-gases. The uranium oxide powder exits the discharge end of the rotary calciner through a cooling screw mechanism and transfers to storage hoppers. A two-stage dust collector system is provided to control and recycle uranium oxide dusts produced in the system during this process.

The uranium oxide in the storage hoppers is packaged into DOT approved shipping containers and transported to an off-site licensed disposal facility.

Off-gas from the rotary calciner flows through two-stages of filters to capture entrained particulates. The particles captured by the filter systems are recycled back as feed to the rotary calciner. After exiting the filter system, the off-gas flow passes through a pre-condenser system to remove AHF and other trace gas contaminants; followed by a two-stage cold trap system that collects the BF_3 product.

The BF_3 product is collected by solidifying in the cold trap system. More than one cold trap is utilized for operating in a loading (collecting) and unloading cycle. When a cold trap is ready to unload, the coolant temperature is set to allow the product to warm and transfer to a storage vessel.

The BF_3 product is chemically separated from licensed material and physically stored in a building separate from the licensed material. The product is packaged as a gas from the storage vessel, using a compressor, into customer cylinders or tube trailers that are a type/design approved by the Department of Transportation (DOT).

The final residual off-gas exits the cold-trap system and passes to the three-stage plant KOH scrubbing system for treatment to remove trace amounts of fluorides before being vented to the atmosphere. Off-gas flows through the plant scrubbing system as described in Section 2.1.3.6.

The BF_3 plant major flows are shown in Figure 2-6.

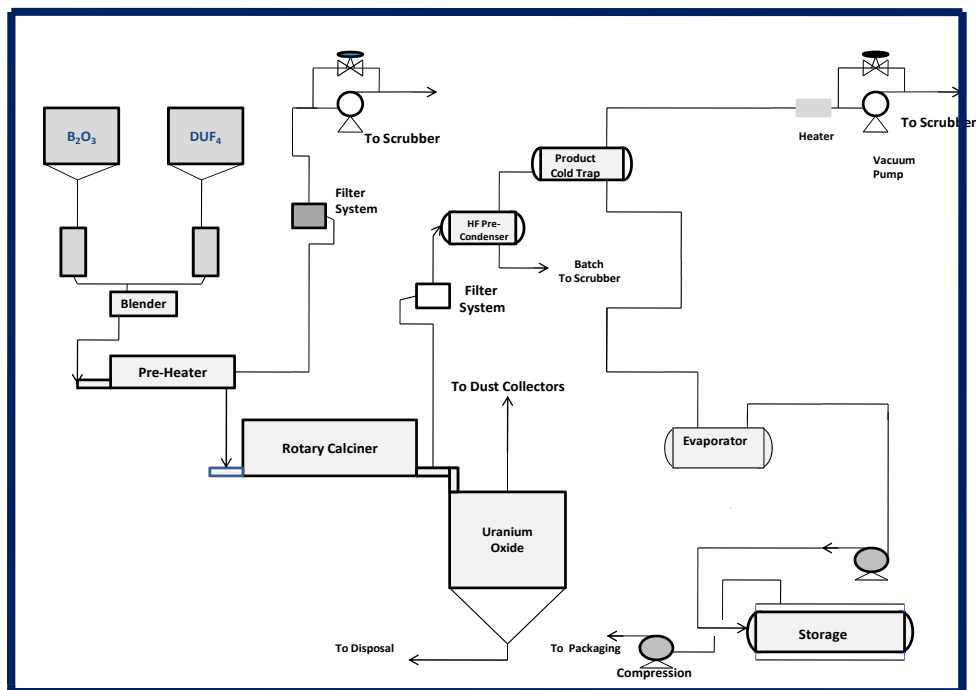

Figure 2- 6 BF₃ Plant Major Flows

2.1.3.5 De-conversion of DUF₆ Directly to Oxide

When a future Phase 2 plant expansion is completed, the additional amounts of the depleted DUF₆ received from supplier/customers for toll de-conversion services may not be used to make FEP products. Any additional amounts of DUF₆ not utilized in the FEP are directly de-converted to uranium oxide, mainly as U₃O₈, and are shipped to an off-site licensed facility for disposal. The final AHF stream is a valuable product that is sold for commercial applications.

In the direct de-conversion to oxide process, the DUF₆ feed is vaporized in the same type design autoclaves as in the DUF₆ to DUF₄ plant. The DUF₆ vapor is fed to a first-stage reaction vessel. The vaporized DUF₆ reacts with a feed of vaporized mixture of hydrogen fluoride and steam that is recycled from the back end (distillation system) of the process. The reaction results in the formation of uranyl oxyfluoride (DUO₂F₂) and hydrofluoric acid (HF).

The DUO₂F₂ powder is withdrawn from the bottom of the reaction vessel and enters a second-stage reaction vessel where it undergoes a reaction with steam to form uranium oxide (U₃O₈) and HF. A more concentrated HF vapor mixture and water exits the tops of the first and second stage reaction vessels and is condensed using heat exchanger equipment. The condensed concentrated HF is then distilled to produce commercial grade AHF. The resulting distillation bottom material of lesser concentrated HF is recycled, vaporized and returned as feed to the first-stage reaction vessel.

Uranium oxide formed in the second-stage reaction vessel discharges the vessel through a cooling screw mechanism and transfers to storage hoppers. A two-stage dust collector system is provided to control and recycle uranium oxide dusts that are generated by air or gas flows associated with the solids handling

equipment. The uranium oxide in the storage hoppers is packaged into DOT approved shipping containers and transported to an off-site licensed disposal facility.

The plant major flows are shown in Figure 2-7.

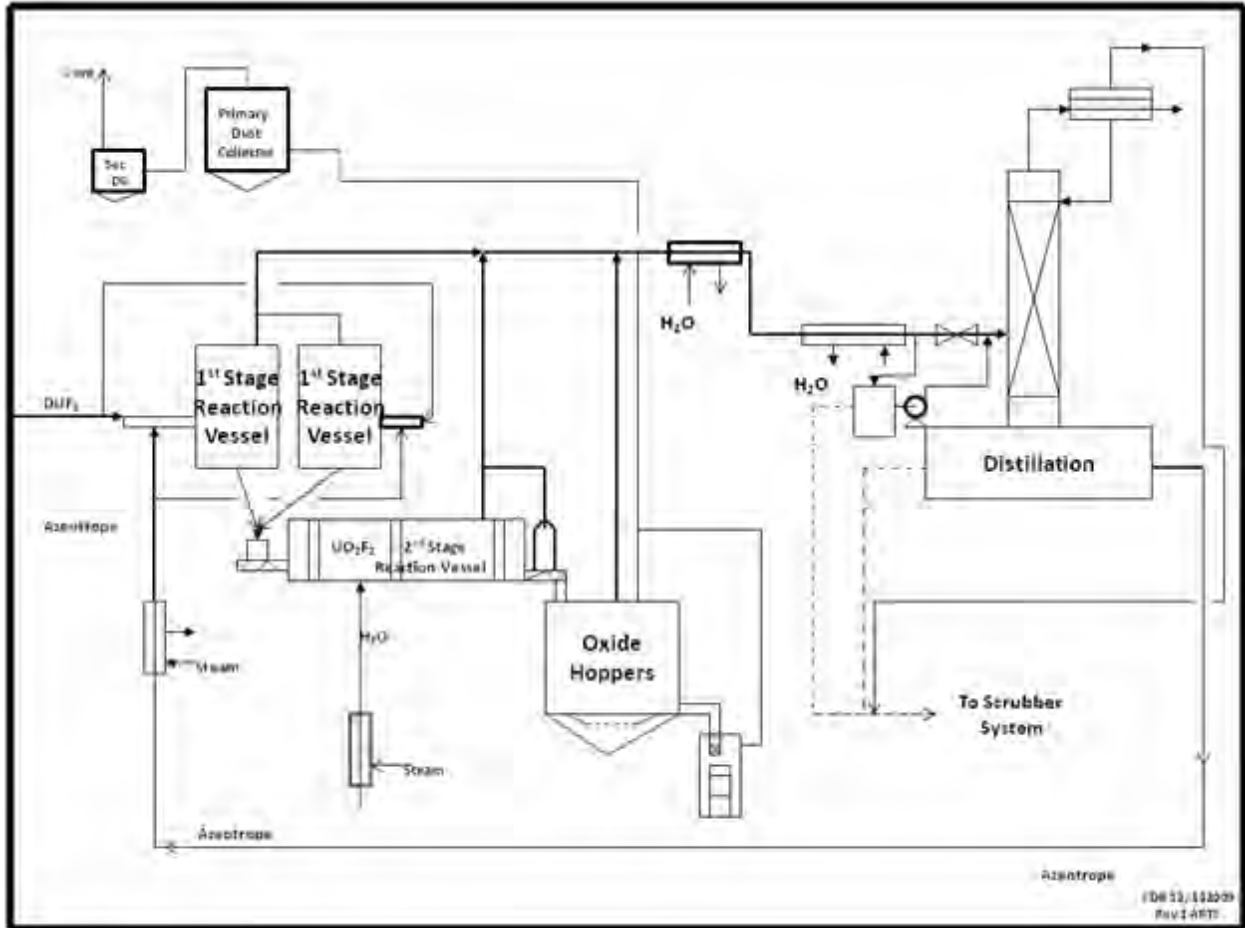

Figure 2- 7 DUF₆ to Oxide Plant Major Flows

2.1.3.6 Process Off-gas Emissions Treatment (Plant KOH Scrubbing System)

Final off-gas streams from the DUF₆ to DUF₄, SiF₄ and BF₃ processes (comprised mostly of nitrogen, air and trace fluorides) enter the Plant KOH Scrubbing System. The off-gases flow through this three -stage scrubber system for treatment prior to be vented to the atmosphere.

There are two parallel line systems that are basically alike to provide operating flexibility. Each scrubber line consists of a primary wet venturi scrubber, followed by a secondary countercurrent-flow gas-liquid packed tower. The third-stage tertiary scrubber is designed to treat gas flow exiting the secondary packed tower scrubber though a bed of sized coke. The coke is wetted by an aqueous KOH solution that serves as the scrubber liquor. An aqueous KOH solution is used and recycled within each of the scrubbers until the concentration of KOH (spent) needs replenishment. The KOH solution concentration in the scrubber equipment is maintained at a safe margin to ensure it effectively reacts (scrubs) with fluoride components in the gas stream.

When there is a need to replenish the KOH scrubbing liquor concentration, some of the spent scrubbing solution, containing potassium fluoride (KF), water and some excess KOH, is pumped from the scrubber recycle tanks to the Environmental Protection Process (EPP). The EPP is described in Section 2.1.3.7.

The system equipment basically consists of a KOH storage tank, KOH pump tank, regenerated KOH tank, two or three (installed spare) venturi scrubbers, two packed towers, and two coke boxes as shown in Figure 2-8. There are redundant pumps for each scrubber, pump tank, and storage tank.

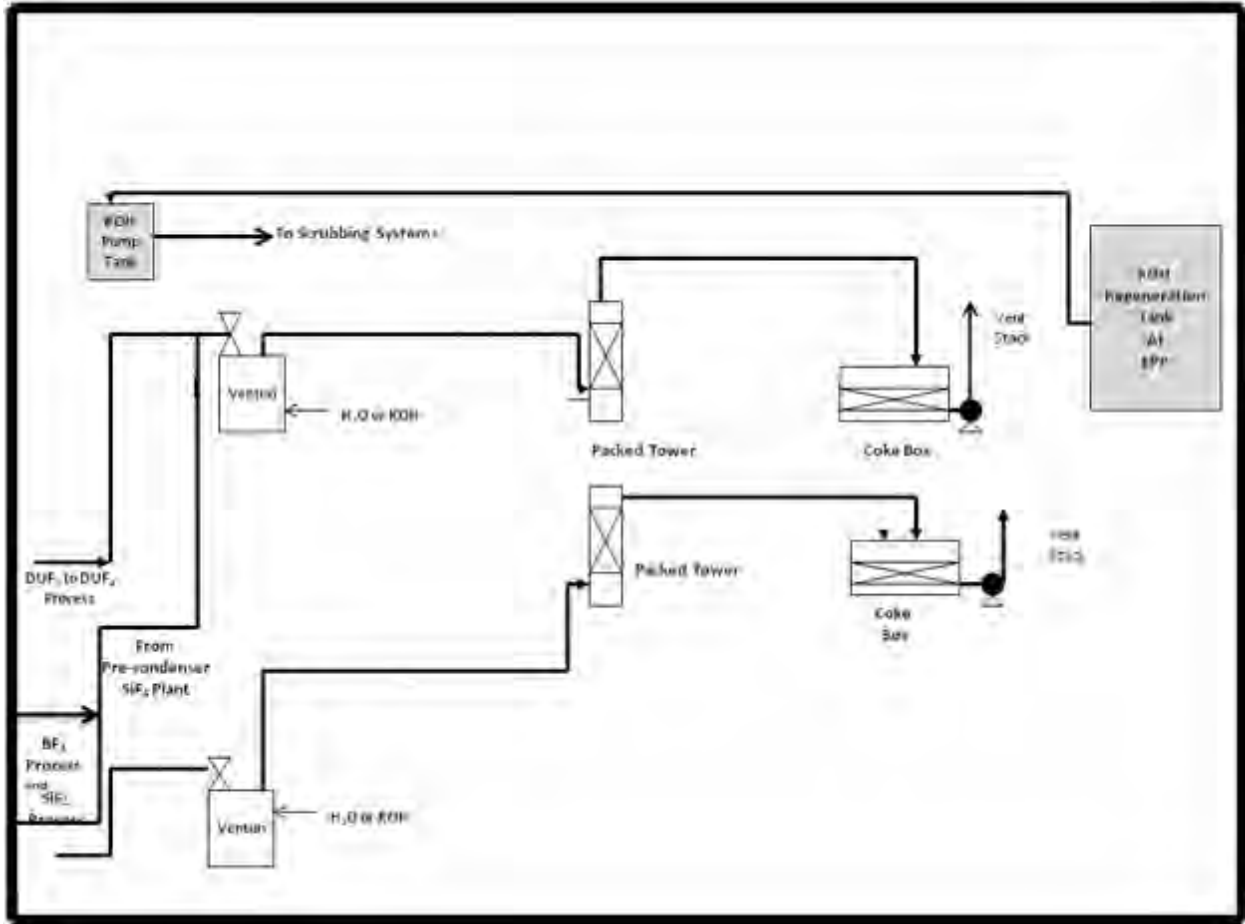

Figure 2- 8 Plant KOH Process Scrubber System Major Flows

Hydrogen fluoride, from the discharge of the DUF₆ to DUF₄ process, and from the SiF₄ and BF₃ pre-condensers, is routed to one venturi. Final off-gas streams exiting the SiF₄ and BF₃ processes, containing some of the uncollected SiF₄ and BF₃ and trace quantities of other fluorides, are routed to another venturi scrubber.

The plant KOH scrubbing system vents treated gases through a single stack. The three-stage KOH scrubbing system is designed for removing fluoride bearing components in the gas streams at approximate efficiencies of greater than 80%, 95%, and 99% for the first, second, and third stages, respectively. The overall system removal efficiency is designed at greater than about 99.9 %. The plant KOH scrubbing system stack is continuously sampled to measure for traces of fluorides or uranium in the vent gas.

2.1.3.7 Environmental Protection Process (EPP)

The Environmental Protection Process (EPP) is primarily a means of treating two types of liquids (solutions) that result from the production processes; potassium fluoride solutions (KOH regeneration process) and weak aqueous HF (HF neutralization process). Each of these materials originates from scrubbing systems designed to prevent air emissions. The potassium fluoride solution is a by-product of using KOH as a scrubbing medium. In the KOH regeneration process of the EPP, the potassium fluoride, water, and excess KOH spent solution from the plant KOH scrubbing system are reacted with a lime-slurry. Calcium fluoride and regenerated potassium hydroxide solution are produced. The regenerated KOH is recycled and reused in the plant scrubbing process. The calcium fluoride is filtered, dried, and packaged for shipment to an approved commercial waste burial site, to an HF producer, or other potential users.

The other stream treated in the EPP is weak aqueous HF solution, water or KOH solution that may contain a low concentration of fluorides. Also, small spills that potentially occur and require clean up from spill control containment areas may contain weak fluoride concentrations. In this case, the fluoride-bearing liquids may have too much water to send to the KOH regeneration/recycle system. The HF neutralization process uses lime slurry to react with weak HF to produce CaF_2 and water.

Figure 2-9 depicts the general flow of the EPP Neutralization and KOH Regeneration and Recycle processes. These processes are discussed below.

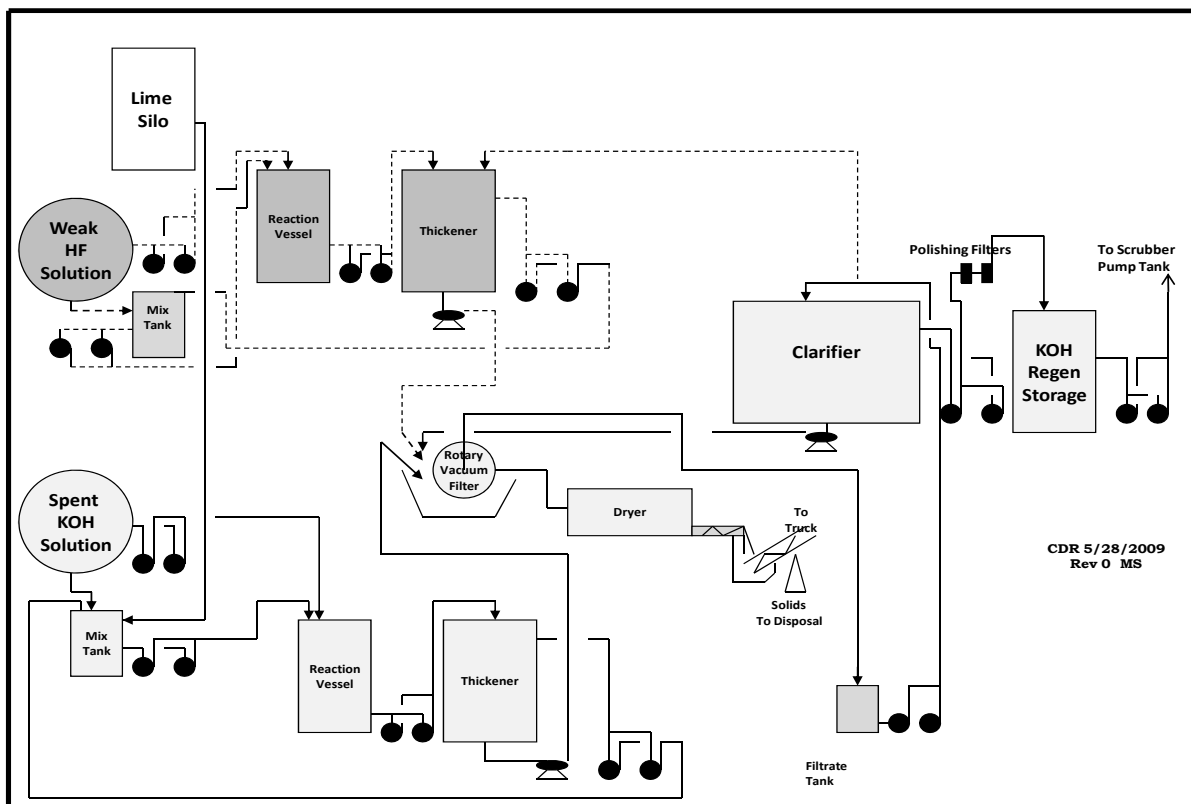
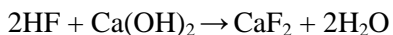

Figure 2- 9 Environmental Protection Process Major Flows

HF Neutralization

The HF Neutralization process is designed to operate intermittently, as needed. A lime silo is provided, including an installed dust collector. The silo holds an inventory of hydrated lime. Lime is fed to a mix tank where it is mixed with harvested water. The slurry generated is ~30% solids. Dilute HF solution is transferred from the weak HF solution tank to an agitated acid reaction vessel that has a volume of about 6,000 gal. The lime slurry from the mix tank is also transferred to the acid reaction vessel. The materials in the acid reaction vessel require a retention time of about one hour or greater for reaction completion. With the reaction complete, materials from the acid reaction vessel are transferred to a thickener tank for settling. After thickening, calcium fluoride and excess lime are transferred by a slurry type pump from the bottom of the thickener to a rotary drum vacuum filter. Solids are discharged from the filter to a dryer capable of removing excess water. Liquors from the rotary vacuum filter are recycled to the weak HF solution tank for recycling. Calcium fluoride, after drying, is packaged suitable for sale or disposal an appropriate off-site licensed Resource and Conservation Recovery Act (RCRA) disposal facility. The primary chemical reaction is:



KOH Regeneration

Lime is fed to an agitated mix tank where it mixes with harvested water. The slurry generated contains ~30% solids. Spent KOH solution (KF solution containing a weak concentration of KOH) is transferred from a storage tank to an agitated reaction vessel that has a volume of about 6,000 gal. The lime slurry from the mix tank is also transferred to the reaction vessel. The materials in the reaction vessel tank are given a retention time of about one hour or greater for reaction completion. With the reaction complete, materials from the reaction vessel are transferred to a thickening tank for settling. Calcium fluoride and excess lime are transferred by a slurry pump from the bottom of the thickener to a rotary drum vacuum filter. Solids are discharged from the filter to a dryer capable of processing excess water. Liquors are transferred to a clarifier where trace solids are settled. Regenerated KOH is removed from the top of the clarifier and passed through a set of filters to the regenerated KOH storage tank. The regenerated KOH solution is pumped to the Plant KOH Scrubbing System as needed for reuse by the scrubbers. Solids are transferred via a slurry pump from the bottom of the clarifier to the rotary drum vacuum filter and subsequently transferred to the dryer. The dried material is packaged and stored for sale or sent to an approved off-site licensed RCRA disposal facility.

The primary chemical reaction is:

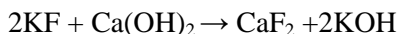

2.1.3.8 AHF Staging Containment Building and Fluoride Products Trailer Loading Building

The AHF product is stored temporarily in the AHF Staging Containment Building until it is loaded into customer or-transporter owned DOT approved tank trailers (typically type DOT-412 trailer, loaded to about 30,000-40,000 lb product) and shipped to customers.

The purpose of the AHF Staging Containment Building and equipment is to provide temporary storage of AHF that is received from the DUF₆ to DUF₄ process AHF condensers. AHF transferred from the DUF₄ Building partial and total condensers is temporarily stored in ~8,000-lb (3,630-kg) tanks of materials of construction compatible with AHF. Dikes are provided around each storage tank. Each dike is sized to

hold the contents of a single storage tank with an additional margin of safety to minimize the surface area (and evaporation rate of liquid) in the unlikely event the tank breaches and spills liquid AHF.

When AHF inventories reach a level for shipment, the AHF is loaded into an approved tank trailer staged in the Fluoride Products Trailer Loading Building. The tank trailer is the type approved by the Department of Transportation (DOT) and of the design/type routinely used for shipping AHF nationwide. A transfer line from the storage tanks enters the tank trailer side of the building. The Fluoride Products Trailer Loading Building has a truck entrance door on one side that remains sealed, closed and controlled, except for short periods when the trailer is moved in and out. Safety precautions, controls and barriers are used to prevent the trailer from inadvertently being moved and from contacting the fill line.

The SiF₄ and BF₃ products awaiting shipment to customers are stored in the FEP Product Storage and Packaging Building until packaged using the respective enclosed packaging station within the Building into customer DOT approved shipping cylinders (typically type 3A or 3AA). The SiF₄ or BF₃ product may be packaged into DOT approved shipping tube trailers, and in this case the product is transferred from the storage vessels to the tube trailer in the Fluoride Products Trailer Loading Building.

The Fluoride Products Trailer Loading Building is connected to the AHF Staging Containment Building and serves the purposes of: 1) loading tank trailers with AHF from storage, 2) loading gas-tube trailers with BF₃ or SiF₄ transferred from the FEP Product Storage and Packaging Building.

The AHF Staging Containment Building and the Fluorine Products Trailer Loading Building are totally enclosed, separated by a containment-type wall and are provided with a leak detection and water spray system that are described below.

The SiF₄, BF₃ and AHF products in the FEP Product Storage and Packaging Building, AHF Staging Containment Building and the Fluoride Products Trailer Loading Building have been chemically separated through several process stages from licensed material. These chemical products are physically stored, transferred and controlled such as not to affect on-site licensed material in the event of a release of these chemicals.

Products (AHF, SiF₄ and BF₃) that are shipped in the approved DOT tube or tank trailers are transferred through independent and safe-pressure designed piping and connections from their respective storage vessels to the product designated trailer in the Fluoride Products Trailer Loading Building. Process hazard analysis is conducted for the storage, handling, and transferring of these chemicals. Safeguards and operational controls are designed and provided for standard industrial chemical safety, and where applicable to meet requirements of OSHA 1910.119, "Process Safety Management," or federal and State of New Mexico environmental permit requirements.

The AHF Staging Containment Building and the FEP Products Trailer Loading Building are not totally leak-tight, but are sufficiently enclosed and sealed to suppress or inhibit releases to the outside environment or into other adjacent buildings in the event of a leak or spill of the chemicals being stored or transfer loaded. A fluoride leak detection and water-spray deluge system provides for additional suppression and mitigation of potential AHF or fluoride product chemical releases.

The fluoride detection and water spray system is a safeguard to knock down fluoride vapors within the building in the event of a leak or vessel breach and minimize the potential of abnormal fluoride emissions to the environment. The system also provides the operational means to facilitate treatment and disposal of fluorides in event of a leak from a container or during transfer operation.

The AHF Staging Containment Building and the FEP Products Trailer Loading Building are equipped with an array of water-fog nozzles that are activated automatically if a leak of AHF or fluoride product chemicals should occur. Fluoride detectors are effectively configured throughout the two containment areas. The detection and control system are designed for automatically closing isolation valves at the storage tanks and at the tank trailer fill lines. The detection system also provides automatic and manual controls for initiating the water deluge system in event of chemical leakage in either building area. In the event one detector activates, an alarm sounds in the area Control Room and any chemical material transfer is stopped by automatic closure of the transfer isolation valves. The condition is investigated and corrected as necessary before starting or resuming transfer operations. If any two or more fluoride detectors activate in a building, the chemical material transfer valves automatically close and the water deluge system is automatically activated for that area. The detection and control system design in the storage tank area is based conservatively on the leakage of the entire contents of one full 8,000 lb (3,630 kg) storage tank of AHF. Once activated, the water flow continues unless investigated and determined to be a false alarm or under control. The system design in the truck loading area assumes that transfer of materials through hose connections and transfer lines is shut off by the automatic detection and control system, controllers and valves, before more than 8,000 lb (3,630 kg) of full-truck contents is released.

There are two positive-air-lock doors in each of the two containment-type buildings. One air-lock in each building is an emergency exit to the outside. The other air-lock in each building is an exit and entrance to a separate control room, under positive pressure, where control and remote surveillance of the buildings and equipment are managed. Parts of the containment-type building structures, trenches and sumps have a protective coating compatible with aqueous HF to minimize corrosion in the event of a leak or spill.

Water from a deluge activation is gravity drained to sump pumps where it is transferred to a large lined carbon steel emergency reservoir tank (HF Recycle Tank) that is vented to the Plant KOH Scrubbing System. In the event the water deluge is activated and fluoride bearing water from the buildings spill drainage system is received into the holding tank, the aqueous fluoride (HF) solution is sent to the Environmental Protection Process (EPP) treatment plant. At the EPP, it is neutralized with lime, forming solid calcium fluoride particles that are separated from the treated water by settling and filtration. The treated filtrate is either recycled for plant process use or evaporated, and the solid particle filter cake is dried. The treated water contained in the solids is evaporated through the calcium fluoride dryer unit. The calcium fluoride is sent to customers or a licensed disposal facility along with calcium fluoride produced in treatment of fluoride bearing liquors from other processes in the IIFP facility.

2.1.3.9 Process Vent Stacks

In the Phase 1 plant, there are three major stacks where treated process gases and particulates are vented to the atmosphere. Prior to venting, the particulate and gas process streams are filtered and/or scrubbed using multi-stage equipment that is configured in series to ensure effective treatment within the established safe and environmental regulated control limits. Additionally, there is one boiler vent stack where combustion products of natural gas, used in the production of steam, are vented to the atmosphere. Another major stack will be added as part of the Phase 2 plant expansion for venting filtered exhaust gas from the Oxide process dust collector system

Table 2-1 provides a listing of the major treatment systems and their design efficiencies. Table 2-2 presents information on stack heights, estimated flow vent flow rates and approximate location of each stack.

The Plant KOH Scrubbing System vents treated gases through a single stack. It is utilized to treat final off-gas streams from the DUF_4 production process (DUF_6 to DUF_4), the SiF_4 and BF_3 processes and the

Table 2- 1 Design Efficiencies for Process Vent Off-gas Treatment Equipment

Component	Design Efficiency	Comments
Table 2-1		
DUF ₄ dust collectors	>99.5% particulates	All primary, secondary and redundant units
FEP uranium oxide dust collectors	>99.5% particulates	All primary, secondary and redundant units
DUF ₄ vacuum cleaner cyclone	>80% particulates	Cyclone discharges to DUF ₄ vacuum cleaner bag house for further removal efficiency
FEP uranium oxide vacuum cleaner cyclone	>80% particulates	Cyclone discharges to oxide vacuum cleaner bag house for further removal efficiency
DUF ₄ vacuum cleaner dust collector	>99.5% particulates	Discharges to inlet of DUF ₄ secondary dust collector
FEP uranium oxide vacuum cleaner dust collector	>99.5% particulates	Discharges to inlet of FEP uranium oxide secondary dust collector bag house
DUF ₄ primary metal filter	>95% particulates	Removes entrained particulates from the DUF ₄ to DUF ₆ reaction vessel off-gas. Discharges to secondary filter for further removal efficiency
DUF ₄ secondary metal filter	>95% particulates	Removes entrained particulates that may pass through the DUF ₄ primary metal filter
SiF ₄ primary metal filter	>95% particulates	Removes entrained particulates from the SiF ₄ rotary calciner off-gas. Discharges to secondary filter for further removal
SiF ₄ secondary metal filter	>95% particulates	Removes entrained particulates that may pass through the SiF ₄ primary metal filter
BF ₃ pre-heater secondary metal filter	>95% particulates	Removes entrained particles that may pass through the BF ₃ pre-heater primary metal filter
BF ₃ primary metal filter	>95% particulates	Removes entrained particles from the BF ₃ rotary calciner off-gas. Discharges to secondary filter for further removal efficiency.
BF ₃ secondary metal filter	>95% particulates	Removes entrained particles that may pass through the BF ₃ primary metal filter
FEP oxide vacuum clean dust collector	>99.5% particulates	Discharges to inlet of FEP oxide secondary dust collector
KOH venturi scrubber	>80% gaseous and particulates	Receives vent gas from DUF ₄ and FEP process off-gas system/Exit gas of venturi discharges to packed tower scrubber for further efficiency
KOH packed tower scrubber	>95% gaseous	Second stage system. Exit gas discharges to coke box system for further removal efficiency
KOH coke box scrubber	>99% gaseous	Discharges to atmosphere through plant KOH scrubbing system vent stack
DUF ₄ off-gas Primary carbon-bed trap	>90% gaseous and particulate uranium	Absorbs DUF ₆ gas and traces of DUF ₄ and discharges to secondary trap for further removal efficiency
DUF ₄ off-gas Secondary carbon bed trap	>95% gaseous uranium	Absorbs DUF ₆ trace gas that may pass through Primary carbon bed. Discharges to tertiary carbon bed trap for further removal efficiency
DUF ₄ off-gas Tertiary	>95% gaseous	Absorbs final traces of DUF ₆ that may pass

Component	Design Efficiency	Comments
Table 2-1		
carbon bed trap	uranium	through the Secondary carbon bed and provides added margin of safety in removing gaseous uranium
DUF ₄ hydrogen burner	>99% hydrogen burned	Gas-fired burner to destroy excess hydrogen from DUF ₆ to DUF ₄ reaction vessel
FEP hood vent system emergency KOH scrubber	>95% gaseous fluoride	Treated gas from emergency scrubber exits to SiF ₄ venturi scrubber in the plant KOH scrubbing system for further removal efficiency.
Future Oxide process primary bag house dust collector (Phase 2 plant)	>99.5% particulates	Primary and secondary bag houses. Primary discharges to secondary for further removal efficiency.
Future Oxide process off-gas venturi scrubber(Phase 2 plant)	>80% gaseous for primary scrubbing; discharges to KOH secondary and tertiary scrubbers for further treatment of off-gases	Receives off-gas from the Oxide process 1 st and 2 nd stage reaction vessels for removal of fluorides. Plant KOH scrubber system venturi scrubbers are converted to water in the Phase 2 plant to provide for recycling of venturi liquors to the Oxide process. In both the Phase 1 and 2 plants, the venturi scrubbers discharge to the KOH packed towers for further removal efficiencies.

Table 2- 2 IFP Plant Major Process Vent Stacks

Redacted - Proprietary Information				
Stack Identification (Number) and Description	Approximate Location	Approximate Height ^a (ft)	Estimate Range of Vent Flow Rates ^b (ft ³ /min)	Main Constituents in Flow Stream
(01) Plant KOH Scrubbing System				
(02) DUF ₄ Dust Collector System				
(03) FEP Dust Collector System				
(04) Utilities Boiler Stack				
(05) (Future Phase 2 Plant) Oxide Dust Collector System				

^afeet-multiply by 0.3048 to get meters

^bcubic feet-multiply by 0.028317 to get cubic meters

future Phase 2 Oxide process. The three-stage KOH scrubbing system is designed for removing fluoride bearing components in the gas streams at efficiencies of greater than 80%, 95% and 99% for the first, second and third stages, respectively. The overall system removal efficiency is designed at greater than 99.9 %. The Plant KOH Scrubbing System stack is continuously monitored to measure for traces of fluorides or depleted uranium in the vent gas.

In areas where depleted uranium particulate solids are handled or processed, such as depleted UF₄ or depleted uranium oxides, dust capture and collection systems are provided. The dust collection systems are filter-type bag houses that are used to remove the depleted uranium material prior to discharging through vent stacks to the outside environment.

Equipment where depleted uranium bearing powders are handled or stored, such as storage hoppers and enclosed drum packaging stations, are connected to the dust collection intakes. Uranium particulate materials captured by the dust collection systems are either recycled back into the respective process operations or packaged and sent to an approved off-site disposal facility. The design efficiency of bag-house dust collectors is greater than 99.5% for each collector. At least two components are used in series to ensure an overall system efficiency of greater than 99.9% in the collection and removal of particulate uranium from the vented process gas.

Sampling and analysis for uranium is routinely performed between each of the bag house units. If an unacceptable level of uranium carryover is detected on any given bag-house unit, the unit is removed from on-stream service, investigated and corrective action taken, accordingly. Additionally, each bag house is continuously monitored for differential pressure across the filter bag sections to ensure bag design integrity is maintained.

2.1.4 Overview of the Facility and Description of Infrastructure

The facility and infrastructure is typical of specialty chemical and industrial facilities. Buildings, in addition to the process buildings, are included for administration, laboratory, maintenance shop, stores inventories, security checkpoints, utilities and powerhouse, and warehousing. Figure 2-10 shows the Facility site plan and layout of the buildings, roads and major infrastructure.

The 40-acre facility site is surrounded by security fence with a surveillance road just inside the fence. Pole mounted security lighting is installed around the entire perimeter of the security fence.

The entrance to the facility is from the west via a paved road (approximately 3/4 mile) that intersects with Highway 483. The road connects with the plant road system at the main gate and guard station. Adjacent to the main gate area and to the north is the paved and striped employee and visitor parking lot. The lot provides parking for employees and visitors.

Located just inside the main security gate is the Guard House from which the main security gate and the entrance road inside the gate are controlled to prevent unauthorized entry. Concrete filled pipe bollards are anchored several feet into the ground are provided for a distance from the main gate entrance to a vehicle control barrier on the road just inside the plant fence to prevent vehicular traffic evasion around the entrance road control barrier. This arrangement provides a corridor for vehicles to be controlled and checked by the Guard. The main entrance road over a distance of several hundred feet ahead of the main security gate is configured such that vehicles are hindered from high speed acceleration upon approach to the gate area. Trucks and other vehicles that require entrance to the facility beyond the Administrative building are checked and logged at the Guard House and, need-of-entry is verified in accordance with plant access and security procedures. All vehicles entering the facility require authorization by the guard

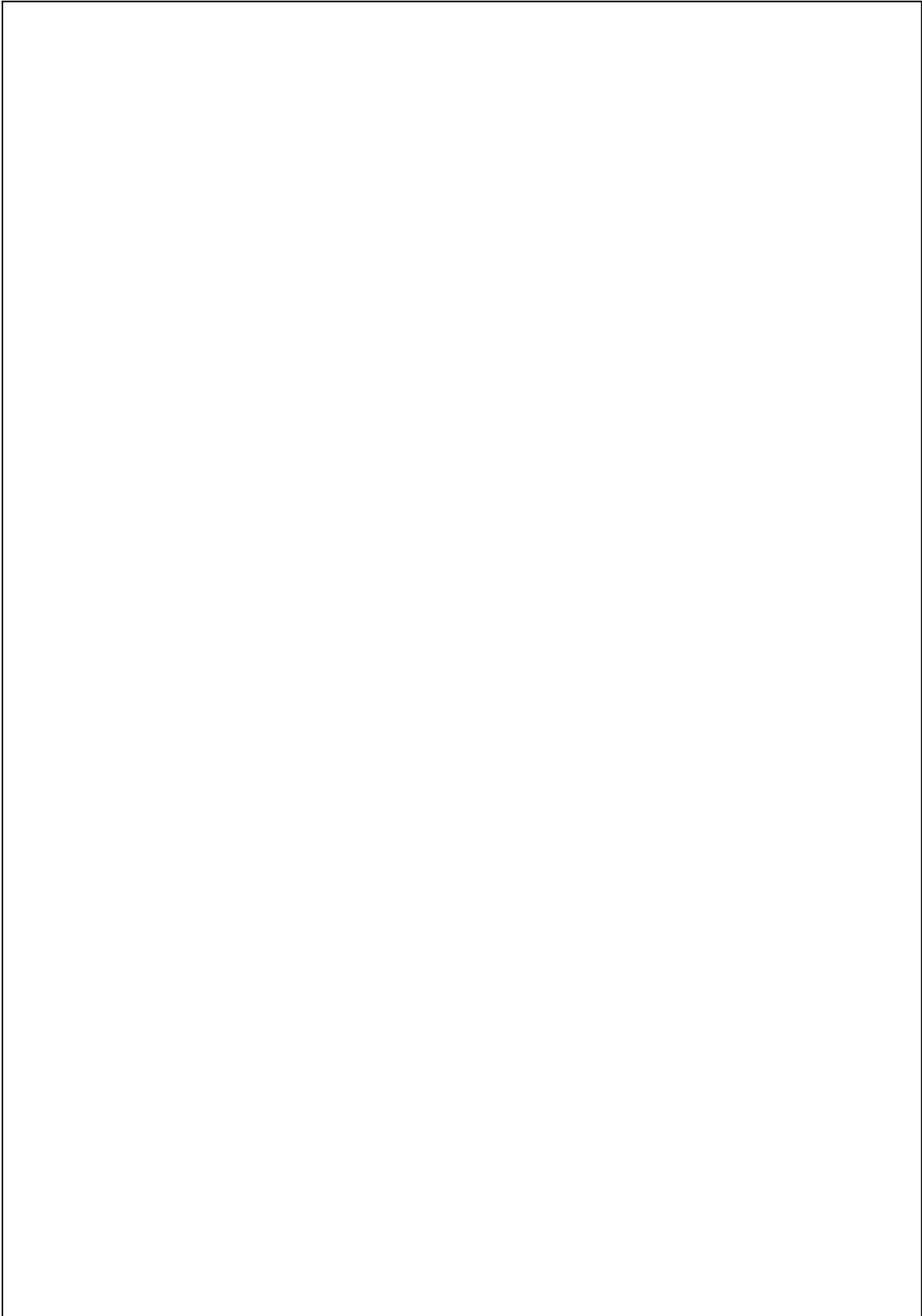

Figure 2- 10 ~~HFP Facility Site Plan~~— Redacted Security Related Information

staff prior to entry. Upon leaving the facility, trucks and other vehicles, are visually checked and logged at the Guard House prior to exiting.

The inside-plant road begins at the main security gate and continues in an easterly direction where it divides into an intersection with two access roads, one heading north and the other heading south. These roads surround the process areas of the facility and eventually meet to form a loop, thereby allowing access around the facility in either direction. The loop formed by the road is approximately 700 feet long (north to south) x 400 feet wide (east to west). For descriptive purposes, the four sections of the road loop are called the North, South, East and West Roads, so named by their proximities to the North, South, East and West boundaries of the 40-acre facility site.

North of the Guard House and east of the parking lot, the Administrative Building with a change/locker area is located just inside the security fence. An access-control station at the security fence allows entrance into plant area leading to the Administrative Building or the change/locker entrance. The exit door from the change/locker area and Administrative Building connects with a concrete walkway leading to the process area of the facility. The visitor control area at the Guard House can be accessed directly from the parking lot. Upon authorization, visitors may then enter the facility via the Administrative Building and associated walkways.

A line of protective, anchored, concrete-filled pipe bollards is installed along the perimeter and outside the security fence from the north edge of the parking lot extending south, and closely spaced except for the width of the main road entry at the main security gate.

Just west of the intersection of the West and North Roads is the Full DUF₆ Cylinder Storage Pad. This pad is used to stage full DUF₆ cylinders for processing. Protective anchored concrete- filled pipe bollards are installed around the perimeter of the cylinder pad in locations where a potential exposure to uncontrolled vehicle traffic exists. The pad is approximately 175 feet wide by 200 feet long and is sized to store up to 60 full cylinders. The entire storage pad is curbed for storm water collection and is provided with underground drains connecting to the Full DUF₆ Cylinder Storage Pad Stormwater Retention Basin located south of the cylinder pad. The surface and slope of the cylinder pad is designed to prevent any significant pooling of liquids.

Approximately 150 ft east of the intersection of the East and South Roads is the Empty DUF₆ Cylinder Storage Pad. This pad is used to contain empty DUF₆ cylinders for staging in preparation for shipment from the facility. An access security fence is installed around the entire perimeter of the cylinder pad with one entrance opening with clearance for the cylinder hauler to maneuver. The pad is approximately 105 ft wide x 185 ft long and is sized to contain up to 40 empty cylinders. The pad is provided with saddles on 6'-6" centers to support the cylinders.

Centered inside the paved road loop are the main process related buildings and equipment including the following:

- DUF₆ Autoclave Building,
- DUF₄ Process Building,
- DUF₄ Container Staging Building,
- Decontamination Building,
- FEP Process Building,
- FEP Oxide Staging Building,
- DUF₄ Container Storage Building,

- FEP Product Storage and Packaging Building,
- AHF Staging Containment Building,
- Fluoride Products Trailer Loading Building,
- SiO₂ Storage Silo,
- Potassium Hydroxide (KOH) Storage Tank,
- FEP and DUF₄ scrubbers and scrubber containment pads,
- future Oxide Process Building,
- future Direct Oxide Staging Building,
- future DUF₆ Autoclave Building, and
- the future HF Distillation Annex.

All the building area aprons and areas around the outside equipment, such as the scrubber systems, have concrete curbing or concrete dikes that are adequately designed to contain and control the single-largest container of liquid chemicals or solutions, in the respective area, in the event a spill occurs. Pad areas and dikes that serve areas containing equipment with potentially hazardous or corrosive chemicals are coated or sealed and maintained to prevent leakage through pad or wall surfaces and joints. The dike areas are also designed with a containment volume safety margin of at least 150 percent of the single-largest container volume in the respective area. Pumps, including an appropriate number of redundant pumps, are installed inside the contained dike areas to transfer liquors to the Environmental Protection Process (EPP) or other appropriate collection or treatment equipment. Controls are provided for detection, alarm and notification to the area Control Room for Operator response in event of a spill. Also, a second level of detection-control is provided to activate automatic pumping to the appropriate treatment facility, if the first level of spill volume exceeds the alarm-response action.

Just north of the process area are located the Process Offices/Lab Building with scrubber and containment pad, closed-loop cooling tower, solar panels, Material Warehouse, Utilities Building and Main Switchgear Building. A truck access road is installed between the Utilities Building and the Material Warehouse loading dock. This access road connects with the North Road.

Inside the intersection of the East and South Roads is located the Maintenance and Stores Building.

Just east of the East Road are located two above-ground Fire Water Tanks (100,000 gallons each) and the Fire Pump House. The Fire Pump House contains the main fire water pump, the back-up diesel fire water pump, jockey pump, piping and controls. The IIFP facility fire protection system is described in Chapter 7, Fire Safety, of this License Application, including the classification of individual buildings as per the New Mexico Commercial Building Code (NMCBC) and *National Fire Protection Association (NFPA) 13* (NFPA, latest edition).

Essentially all the process equipment is located within building structures, where feasible. Process buildings that function as product and waste material storage have separate areas for each purpose. Those areas have loading/unloading docks to facilitate shipping. Process buildings have aprons, curbing and dikes and external pads have curbing and dikes where chemicals are stored or handled. Pumps are provided on pads and in building selected areas to transfer chemicals to containers or to the EPP in event of a spill or leak.

Auxiliary buildings generally house:

- Materials;
- Maintenance shop;
- Laboratory equipment;
- Steam boilers and supporting utilities;
- Electrical utility equipment;
- Sanitary water treatment, certain equipment for process water treatment and recycle, and
- Accommodation for personnel work, break-rooms, change-rooms, and toilets.

Buildings, lighting, fire protection, and building support systems are designed in accordance with latest revisions, of building and construction codes including where applicable the National Fire Protection Association (NFPA) standards, local and State codes, and related codes and standards.

2.1.4.1 Process Buildings and Process Areas

The DUF₆ Autoclave Building, DUF₄ Process Building, DUF₄ Container Storage Building, DUF₄ Container Staging Building, Decontamination (Decon) Building, FEP Process Building (SiF₄ and BF₃), the FEP Oxide Staging Building, FEP Product Storage & Packaging Building and the EPP Building are of structural steel beam and column construction with metal wall panels and with Class 1 metal roofs as approved by Factory Mutual (FM)-4450 (FM, latest edition) or as classified by Underwriters Laboratory (UL) standard 1256 (UL, latest edition). The first floor of each building is constructed of reinforced concrete with curbing to function as a containment barrier. Located in the northeast corner of the access pad and adjacent to the DUF₄ Process Building, is the DUF₄ Container Staging Building. This building is used for removing DUF₄ from DUF₄ shipping containers that may be received from suppliers and for transferring into the DUF₄ hoppers located in the DUF₄ Process Building.

The AHF Staging Containment Building and the Fluoride Products Trailer Loading Building are constructed of reinforced concrete floor slabs turned up to form containment barriers. The upper sections of these buildings are of concrete block construction with Class 1 metal roofs meeting FM and UL requirements as stated above.

Radiological boundary control hand-foot monitors are strategically located at building walkway exits of areas where licensed materials are handled. Fluoride and radiological detection systems, local alarms and alarm notification to Controls Rooms are also strategically located in those building areas, where applicable.

The process buildings are multi-story buildings where necessary to provide requirements for equipment space and to provide elevations for permitting gravity flow of particulate solids. The upper floors are configured such as to provide adequate room for equipment function and maintenance. The upper floor areas below equipment and piping containing powdered materials are constructed of reinforced concrete with curbing and seal coatings on floor and wall surfaces. Other upper floor areas of the buildings are constructed of metal grating or metal flooring.

Process Control Rooms are provided in the major processes, including appropriate monitoring, recording, alarm notification and control instrumentation. Control Rooms are located separately for the DUF₄ Process Building and the future Phase 2 Oxide Process Building (direct de-conversion of DUF₆ to uranium oxide). The Autoclave Building and future Phase 2 Autoclave Building are controlled from the DUF₄ Process Building and Oxide Process Building Control Rooms, respectively. The FEP plant has its

own process Control Room for the SiF₄ and BF₃ processes. The AHF Staging Containment Building and Fluoride Products Trailer Loading Facility share a Control Room. Likewise, one control area is located in the Utilities Building for monitoring and controlling the steam boiler system, air compressors and other utility supply equipment. Control room areas and electrical and instrument rooms are typically of concrete block construction with concrete or metal roofs. Ceiling assemblies and fire walls separate these areas from production areas of the facilities. Process area control rooms, where routinely occupied by workers, have environments maintained for comfort and safety. Control rooms located in process areas, where uranium or hazardous chemicals are processed, stored or handled, have separate heating, ventilation and air conditioning (HVAC) systems. The Control Rooms in these areas are designed to maintain a positive pressure environment with high-efficiency filtration of intake air and are provided with low pressure alarms to notify occupants should a loss of pressure inside a control room occur.

The process buildings are classified per NFPA 13 as Ordinary Group 2 and are protected with 100 percent coverage, wet-type fire protection sprinkler systems with Class 1 standpipes between floors in all exit stairways of multi-story buildings.

Facility Buildings

A listing of the major buildings and estimated sizes is provided in Table 2-3.

2.1.4.2 Utilities Requirements

Utility resource requirements include electrical power, steam, natural gas, dry air, water and liquid and gaseous nitrogen. The Utilities Building contains a package steam boiler, a smaller spare steam boiler for necessary backup supply; associated boiler feed water softening and treating equipment; and compressors for generating plant air and air driers, as needed. A separate electrical substation and switchgear building are provided to supply and distribute electrical power requirements.

Electrical

The electrical power load demand in the facility is mostly for operating four reaction vessels (calciners) in the FEP product plant, the refrigeration system and reaction vessel in the DUF₄ plant and later in the operation of the 2nd-stage reaction vessel of the future Phase 2 Oxide process. The substation and major line-distribution system are designed for the plant at an estimated 4.9 VA. As detailed design and engineering proceeds, the electrical take-off calculations for specific equipment will better define load demands by area. The Main Switchgear Building houses the electrical gear, breakers and electrical systems for control and distribution of the main electrical power.

Steam

Steam is the primary heat source for vaporizing DUF₆ in the autoclave, heating some process and warehouse buildings, and tracing pipes, in some cases, to prevent solidification of temperature sensitive substances.

Steam requirement for the Phase 1 facility are estimated at about 2,500-3,500 lb/hr based on routine operations at design capacities. When the Phase 2 facility becomes operational, the total load will increase to about 6,000-8,000 lb/hr. Steam is generated on site at 150 psig using a package boiler of about 10,000-lb/hr capacity. The 10,000 lb/hr unit capacity is being used in the environmental assessment for evaluation emissions from the boiler stack.

Table 2- 3 Major Buildings and Estimated Sizes

BUILDING (Areas where uranium is processed or stored are marked in "bold" print")	DIMENSIONS (feet)			APPROXIMATE AREA (square feet)	APPROXIMATE VOLUME (cubic feet)
	LENGTH	WIDTH	EAVE HEIGHT		
PHASE 1 and FUTURE PHASE 2 PLANTS					
DUF₆ Autoclave Building	90	60	40	5,400	216,000
DUF₄ Process Building	50	50	70	2,500	175,000
DUF₄ Container Storage Building	40	40	18	1,600	28,800
DUF₄ Container Staging Building	25	25	18	625	11,250
Decontamination (Decon) Building	50	30	30	1500	45,000
FEP Process Building (SiF₄ and BF₃)	60	40	60	2400	144,000
FEP Oxide Staging Building	40	20	30	800	24,000
FEP Product Storage & Packaging Building	50	35	18	1750	31,500
AHF Staging Containment Building	40	30	30	1,200	36,000
Fluoride Products Trailer Loading Building	90	20	20	1,800	36,000
Maintenance & Stores Building	60	50	15	3,000	45,000
EPP Building	40	30	18	1,200	21,600
Lime Silo Storage Shed	20	20	8	400	3,200
Utilities Building	50	50	18	2,500	45,000
Material Warehouse	100	50	18	5,000	90,000
Main Switchgear Building	50	40	18	2,000	36,000
Fire Pump House	10	10	15	100	1,500
Water Treatment Building	30	15	15	450	6750
Process Offices	50	30	15	1,500	22,500
Laboratory (Small uranium samples handled)	30	30	15	900	13,500
Administrative Building	80	50	15	4,000	60,000
Guard House	25	20	10	500	5,000
FUTURE PHASE 2 PLANT ADDITIONS					
Future DUF₆ Autoclave Building	90	60	40	5,400	216,000
Future Oxide Process Building	50	50	70	2,500	175,000
Future Direct Oxide Staging Building	50	20	30	1,000	30,000
Future HF Distillation Annex	25	20	60	500	30,000

The steam boiler package includes a softener system for the feed water, standard blow-down capabilities, and associated steam and fuel controls. The boiler operates on natural gas and is located in the Utilities building. A spare package redundant boiler, of about 5,000 lb/hr is planned for maintaining reliable heat source capabilities.

Condensate from autoclaves, line traps, heating units and process equipment is collected in local condensate tanks for temporary holding and flow control. Condensate is either treated and returned as feed to the steam boiler or used as makeup water in the process. Boiler blow-down is sent to the EPP for treatment, if needed, and evaporated at that point.

Compressed Air

Compressed air is needed for operation of some instrumentation, control valves, dust collector blow-back, hopper vibrators and some miscellaneous uses. Air is compressed and dried using vendor standard selected compressors to deliver approximately 100 psig. Air regulators and controls are specified as part of the detailed engineering and procurement package.

Nitrogen

Nitrogen is required for purge gas systems and in the process mainly for cooling of pre-condensers and product cold traps in the FEP process building. Liquid nitrogen is used for the cold traps. The cold nitrogen vapor exiting the product cold traps will be re-used for the pre-condenser cooling. Gaseous nitrogen leaving the condensers is collected and compressed to supply gaseous nitrogen in other parts of the facility where a dry inert gas is needed. The main application is for purge and seal systems, such as the rotary calciner inlet and discharge seals. A cost-benefit analysis will be conducted during detailed design to determine whether to make or buy the liquid nitrogen or to utilize another type cryogenic system, such as gaseous helium. It is assumed for the environmental assessment that liquid nitrogen is procured from a vendor.

Water Supply

The plant requires relatively low volumes of incoming water because of designs for recycling process water and re-circulating the cooling water. A preliminary estimate of water supply requirement is less than 10,000 gallons per day. Sanitary water usage for showers, lavatories, drinking, toilets and the laboratory comprise 3,000-4,500 gal/day of the total.

There is currently no municipal water line within a reasonably close distance to the plant site. Some other plants in the local area use ground wells as water supply. Ground wells are used for the IIFP plant coupled with a packaged treatment plant to render the groundwater acceptable for sanitary and drinking water use.

Heat, Ventilation and Air Conditioning

Steam is used as the main heat source for process building environment. Process control room areas are served by electrical or gas supplied heat pump units for heating and air conditioning. Process equipment areas are open and of large volumes, so steam heating is practical. Cooling of the large process and storage areas of low occupancy is by fresh air ventilation either by roof-fan or side-wall vents. Smaller process areas that are routinely occupied by personnel, such as the product packaging areas, are cooled by local HVAC refrigerant type units. Final decisions on types, locations, number of units and thermal loading is pending the architecture and engineering details with respect to building design and layout.

Ground-Thermal System

Administrative, stores, process offices, laboratory, guard station and other personnel high occupancy areas are heated and cooled by ground-thermal systems. The current concept is to design, select and install two systems close to consumers.

A total 60-ton capacity (720,000 British Thermal Units, BTUs per hour) is estimated for the buildings identified and currently sized in the plant concept. Actual sizing, selection and engineering of the system will be decided in later detailed engineering work.

Solar Power Supplement

Plans are to use a combination of solar electric supply ground mount and roof space panel systems to supplement some building lighting and light-duty auxiliaries, such as small fan motors and battery chargers. Conceptually, two-30 kilowatt direct current (DC) grid, about 21KW alternating current (AC), ground-mount systems are being considered for supplemental electrical supply to the EPP building areas. Those systems would be located in the large open area near the EPP. Each would occupy about 76.2 x 6.1 m (250 x 20 ft) space. A typical ground-mount system under consideration is shown in Figure 2-11.

Plans are to include, as part of the solar use concept, some roof mounted units totaling slightly over 60 KW alternating current capacity. Those units would be a supplemental power supply to selected process, warehouse and maintenance shops.



Figure 2- 11 Solar Ground-mount Grid System

Based on the current conceptual design, each roof panel will be about 2,300 ft². A ballast-type grid system could be used on roofs; as shown in Figure 2-12. During detailed design, size and rating of these systems can be better defined.



IIFP plant site in Hobbs NM is an excellent location for utilizing solar units.

Figure 2- 12 Roof-Solar Units

2.1.4.3 Equipment Support Pads and Spill Containment

Most of the process equipment is located inside the process buildings. There are some storage tanks, air scrubbing equipment and utilities equipment located outside. Process building concrete aprons and pads layout designs are arranged for closeness to the inside process equipment for each building, respectively.

Process pads, where chemicals or hazardous materials are stored or handled, have dikes with sealed seams between the dike walls and concrete pad. The dike areas are designed to have an excess total capacity plus a design margin of safety for any one of the largest containers, vessels or tanks within the area.

Building aprons and pads that do not require dikes for spill control have curb designs to collect rainwater from building roofs and to prevent erosion. This arrangement helps prevent contamination of soil in the areas near process buildings in event of a leak or spill outside the normally controlled containment areas. In this design concept, runoff from building roofs and non-hazard areas is sent via the storm water sewer system to a double-lined retention basin designed to collect and evaporate storm water. It is unlikely that roof and non-hazard designated pads would contain radioactive or chemical contamination. The storm water runoff system design provides a means to collect and sample, if needed, this retained water. The collection and evaporation of rainwater from the process and plant areas proper provides reasonable assurance for operating the plant with minimal risks relative to storm water disposition.

2.1.4.4 Water Treatment

Cooling Water

Re-circulated cooling water is used in refrigeration systems, chillers, and process heat exchangers. Cooling water is treated for corrosion prevention and protection relative to fungi, mold and Legionnaire disease organisms. The closed-system avoids effluent treatment in general owing to little to no waste discharge.

In the event of a spill or leak around the chillers or cooling systems, the cooling water is collected in the spill containment areas, pumped to the EPP holding tanks where it could be lime-treated, neutralized and evaporated through the EPP dryer unit. Chemical residues are likely be very small amounts, if any, and will be disposed in an approved Resource Conservation and Recovery Act (RCRA) permitted disposal site. Small amounts of boiler blow-down water will also be sent to the EPP to be treated in the same manner.

Plant-Water Treatment

Plant water supply is from an on-site well(s). Civil engineering and surveys have not been performed, so characterization of the well water is not fully defined. The current water supply treatment concept is to employ packaged treatment that provides well water to meet specifications for plant boiler raw water feed and for cooling water make-up needs. The boiler raw feed is further treated in the Utilities building, for example through softeners, to meet the boiler feed specifications. Part of the raw water is pumped to separate storage and treated to meet drinking water standards for sanitary supply. About 3,000-4,500 gal/day of raw well water will need to be treated in a sanitary intake water packaged unit. The package unit treatment equipment and controls are housed in the Water Treatment Plant Building

2.1.4.5 Sewer Systems and Collection Basins

Storm Sewers

The facility storm sewer systems design assumes a 100-year return period storm of 8.9 to 10.2 cm (3.5 to 4-in) rain of 1-hour duration for the Hobbs, New Mexico area. Preliminary engineering of the drainage system size and layout was done to estimate costs and determine requirements and information for additional detailed design later. The early design encompasses an area of the facility that includes the process buildings, auxiliary buildings, pads, roads, parking lot and the water treatment and electrical substation areas in the back acreage of the facility. All the storm sewer systems are inside the inner fenced area and collect rainwater runoff from an estimated 20-25 acres including roadways, building roofs and pads.

Storm Water Holding and Evaporation Basins

Two collection basins are planned for use in handling surges of storm water drainage. One serves the full DUF₆ cylinder storage pad. The other is the main holding basin for collection of the total site storm sewer drainage. Preliminary engineering calculations estimate the main basin needs to be approximately 100,000 cubic feet volume, assuming a 20% freeboard above the maximum design water level. The basin is double-lined with impervious synthetic materials typically used in these applications. Current plans are to use a sand base with a layer of geo-synthetic liner and a second layer of high density polyethylene. Detail engineering and specifications will be refined after civil data are obtained from the site surveys and further discussions with the State of New Mexico regarding permits.

Considerable detail design and engineering is required to meet state and local requirements relative to the retention/evaporation basins including bird netting and lining specifications and design. Given the plant basins are strictly for storm water collection and disposition, some of the issues normally encountered with holding basins are avoided.

Sanitary Sewer

Preliminary design of the currently planned sanitary system provides for capability to handle hydraulic loading of about 3,000-4,500 gal/day.

Treatment of sanitary sewer discharge uses a packaged system for primary and secondary digestion and activation. Tertiary treatment, most likely ultraviolet or other effective disinfection, follows. Biomass generated by the treatment is removed from the plant site by an approved and licensed haul and disposal contractor. The triple-treated water will be re-used in the plant or for landscape or tree watering.

Process Sewer

Water and solutions used in process equipment and KOH liquors used in air emissions scrubbing units are pumped, when contaminant concentrations dictate, to the EPP via above ground piping. The design, in some cases, is double-walled pipes where significantly hazard solutions may require rigorous spill/leak prevention. This design is used where such piping could not practically be located within a contained spill control area.

Process water is not transported through underground sewers, and the facility is designed such as not to require process sewers.

2.1.4.6 Fire Protection

Two redundant above ground fire water storage tanks of 100,000 gallons each are provided to supply immediate demand. Water supply is from the groundwater wells with booster and jockey pumps to maintain supply to and from the reservoir. An electrical fire water pump and an emergency diesel fire water pump are provided.

The plant fire protection system is based on National Fire Protection Association standard NFPA 13 and the New Mexico Commercial Building Code (NMCBC).

Details of the fire safety program including further description of fire protection system are provided in the IIFP License Application; Chapter 7, "Fire Safety."

2.1.4.7 Other Major Buildings

Decontamination Building

The Decontamination Building is located adjacent to, and on the north side of the DUF₄ Building. The construction provides for a fire barrier between the Decontamination Building and the DUF₄ Building. This building is used for decontamination of equipment for maintenance and removal of uranium from decontamination wash waters or from small volumes of contaminated liquors. The Decontamination Building contains an equipment cleaning booth and hood system, primary and secondary dust collector system in series, contaminated-water holding tanks, primary and polishing filters, associated pumps, piping, field equipment instrumentation panels, ion exchange columns and associated controls and backwash systems.

DUF₄ Container Storage Building

Just east of, and adjacent to, the FEP Oxide Staging Building is the DUF₄ Container Storage Building. This building is used to store shipping containers of DUF₄ that may be received from suppliers. This source of DUF₄ can be used in production of FEP products and/or de-converted to depleted uranium oxide.

Fire Pump House

The Fire Pump House is located on the east side of the access road loop and between the two fire water storage tanks. This building houses the fire water pumps, interconnecting piping and controls for the facility fire water system. A fire wall separates the main fire water pump from the diesel powered emergency fire water pump.

Administrative Building (Offices)

The Administrative Building houses the offices of personnel not directly involved in the production and maintenance functions of the facility. This building is accessed directly through the front door from the parking lot. The rear portion of this building is the Change/Locker Area with toilet facilities, showers and lockers. The main employee entrance and boundary control area are located on the west side of the Change/Locker Area. A turn-style and access controls are located at the security fence permitting employee entrance into the controlled area.

Process Offices/Laboratory

The Process Office Building is located adjacent to, and north of the DUF₄ equipment access pad. This Building contains the offices for the engineering, technical, ESH and plant production supervisory staff. The north side of this building contains the Laboratory that is furnished with work benches, equipment, analytical instrumentation, fume hoods, containment devices and exhaust systems with vent streams exiting to an outdoor scrubber on a containment pad just east of the Laboratory area. The Laboratory area provides areas that receive, prepare, and store various samples as follows:

- Health Physics Lab for calibrating instrumentation and counting samples,
- Chemical Laboratory for the analyses of process and product samples, and
- Environmental Monitoring Lab for the process of environmental/regulatory analysis.

Maintenance and Stores Building

The Maintenance and Stores Building is located southeast of the Fluoride Products Trailer Loading Building. This building contains small tools, machines, repair equipment, and maintenance supplies such as pipe and fittings, hardware, electrical parts and other small items required for maintenance of the facility. No raw, licensed, or in process materials or finished products are stored in this building. An office area is provided for maintenance supervision and stores personnel.

Material Warehouse

The Material Warehouse is located just northeast of the Process Offices/Laboratory Building. This warehouse is used to receive and store such items as piping components, electrical conduit, wiring, equipment for capital construction projects and spare parts. Small quantities of chemicals such as paints, oils, and cleaning agents are stored in the warehouse, but the quantities are limited to meet NMCBC and NFPA requirements. No licensed, raw, or in-process materials or finished products are stored in this building.

Water Treatment Building

The Water Treatment Building is located east of the electrical utility substation and adjacent to the facility water wells. This building contains the domestic water storage tank, pumps, treatment system, and controls required to furnish potable water for use throughout the facility.

Main Switchgear Building

The Main Switchgear Building is located just east of the Utilities Building. This building houses the incoming main switchgear distribution and metering equipment for the facility. The main switchgear is fed from the electrical utility substation located just inside the north fence line.

Locker/Change Area and Boundary Control Area

The Boundary Control Area is the point of demarcation between non-contaminated areas and potentially contaminated areas of the plant. These facilities include space for hand and foot monitors, hand washing facilities, safety showers, and boot barrier access. These facilities also contain employee lockers and offices. Change and locker facilities will be provided for approximately 200 people.

Guard House

The Guard House is located at the entrance to the plant. It functions as a security checkpoint for all incoming and outgoing traffic. Employees, visitors and trucks that have access approval are screened at the Guard House. All vehicle traffic including common carriers, such as mail delivery trucks, are checked and authorized for access to the facility at this location.

2.1.4.8 Monitoring Stations

IIFP monitors both for radiological and non-radiological parameters. Descriptions of the following monitoring stations and the parameters measured are described in another section of the ER:

- Meteorology (ER Chapter 3, section 3.6)
- Water Resources (ER Chapter 3, section 3.4)
- Radiological Effluents (ER Chapter 6, section 6.1)
- Non radiological Effluents (ER Chapter 6, section 6.3)

2.1.5 Decommissioning

At the end of useful plant life, the FEP/DUP facility will be decommissioned such that the site and remaining facilities may be released for unrestricted use as defined in 10 CFR 20.1402 (CFR, 2008b).

A Decommission Funding Plan (DFP) for the near-term Phase 1 facility is developed and provided as Chapter 10 of the IIFP NRC Licensing Application. Prior to expanding the facility to Phase 2, the DFP will be updated as part of the Phase 2 licensing process.

The overall strategy for decommissioning is to remove all radioactive contaminated materials and hazardous chemicals from the site such as to release the facility and the site for unrestricted use. Materials will be disposed in licensed facilities in accordance with their final characterization. Some radioactive contaminated materials may be de-contaminated for disposal as opposed to disposal as low-level radioactive waste (LLW).

Hazardous wastes will be treated or disposed of in licensed hazardous waste facilities. Disposal of radioactive or hazardous material will not occur at the plant site, but at licensed facilities located elsewhere. Following decommissioning, the facilities, infrastructure and site will be available for reuse.

This decommissioning approach begins shortly after final shutdown of the facility and avoids long-term storage and monitoring of wastes on site. The type and volume of wastes produced at the FEP/DUP facility do not warrant delays in waste removal normally associated with a deferred dismantlement option.

IIFP presently intends to utilize a surety bond and Standby Trust Fund as the method to provide reasonable financial assurance of decommissioning funding. At least six months prior to startup of the Phase 1 facility, IIFP will provide NRC the financial assurance instrument that IIFP intends to execute. Upon finalization of the specific funding instrument to be used and at least 21 days prior to the commencement of operations, IIFP will supplement its application to include the signed, executed documentation. The surety bond and fund will provide assurance that decommissioning costs will be paid in the unexpected event IIFP is unable to meet its decommissioning obligations at the time of decommissioning.

The environmental impacts of decommissioning are further discussed in Chapter 4 of this ER and the cost-benefits impacts of the de-commissioning phase are described in the ER Chapter 7.

2.2 Alternatives for Site Selection

A site selection study was conducted for the Proposed Action for the purpose of locating a suitable site for the construction and operation of IIFP facility, based on technical, safety, economic, and environmental factors. The process used in the site selection is described below and involves a solicitation of community interest and then a two-phased screening approach to locate a suitable site. Upon receipt of community interest, a first-phase screening was conducted and involved the evaluation of 6 sites. The second phase of the screening analysis consisted of a more detailed analysis of the sites that remained after the first screening phase, against additional criteria as well as more detailed sub-criteria for evaluation.

2.2.1 Methodology

The selection process (Thomas, 2009) was intended to insure that the chosen site was consistent with organizational goals and a host of environmental, operational, economic, and political considerations.

2.2.1.1 Solicitation of Interest and First-Phase Screening

The first step of the analysis involved an Inquiry Package sent to several communities in geographical regions that were potentially attractive to INIS. The Inquiry Package included a request for information about the community and any interest or proposals they would have for accepting and attracting an IIFP facility into their communities. Several responses were received and a list of 6 candidate sites resulted from the first-phase screening process. Two candidate sites were eliminated; one being too remote from utilities and the other had potential legacy waste issues.

2.2.1.2 Second-Phase Screening

The remaining four sites were evaluated using a qualitative evaluation and cost-benefit evaluation. The results of this evaluation (Thomas, 2009) determined that two of the sites were not beneficial due to location and excessive land and/or infrastructure costs. This information was communicated to the economic development councils representing each site. The councils then offered two new sites. One of the newly offered sites was eliminated since the contract for the land could take months to resolve and the site had numerous oil wells. One of the original community sites was also removed from the candidate list because one of the newly offered sites in that region was determined to be more beneficial than the original community site. The three remaining candidate sites were further evaluated using pre-established selection criteria including the following:

Public and State Support

Public and state support is a mandatory requirement in the site evaluation. Support for nuclear facilities and for the IIFP facility was excellent at each of the sites evaluated. The public, local officials and State legislators participated in public meetings held in the three final candidate site communities about the IIFP proposal. Their comments were generally overwhelmingly supportive. Two of the candidate sites exhibited a higher level of regulatory support due to their past experience with site selection of the Louisiana Energy Systems (LES) and the AREVA, Inc. centrifuge plants. All three sites met the mandatory IIFP site selection criteria for public and state support.

Seismic

Two of the sites evaluated are within 30 miles of each other and the LES National Enrichment Facility (NEF) centrifuge facility. Therefore, the sites have similar seismic characteristics. Probabilistic ground motion for the sites is shown in ER Table 3-2, “Seismic Criteria for New Mexico Site,” in Section 3.3.1 Seismology. Seismic activity is well documented as the result of the LES/NEF license (NRC, 2004) and the extensive network of seismometers established for the WIPP facility at Carlsbad, New Mexico, (DOE, 1980) appropriately 87 km (54 mi) from the proposed site. The two sites are in a seismically quiet region, with nearby earthquakes being small in magnitude and generally caused by oil field injection activities (Yarger, 2009)

The third site candidate was determined to be in a more seismic active region.

Land/Soil Issues

Soils at two of the candidate sites are sandy and well drained, with a well-developed Caliche layer occurring at the surface or as shallow as 25 to 30 cm (10 to 12 in) below the surface in some areas of the sites. Caliche refers to a buff, white, or reddish brown calcareous material commonly found in layers on or near the surface of soils in arid regions. “Calcrete,” “duricrust,” and “hardpan” are other terms used to describe Caliche in its various forms. No soil sample borings are available for these sites; however, the deposit of Caliche cap across the sites is expected to occur in a thickness range of 2.4 to 7.6 m (8 to 25 ft). Caliche is a local construction material due to its compaction properties. Caliche is frequently used for the construction of well pads, surfacing roads, and as a compacted base-course for buildings and paved roads.

Two of the sites evaluated have a Caliche rock layer that will have to be negotiated for civil construction work. Those sites are nearly flat with a slight slope that accommodates drainage (Thomas, 2008).

The third candidate site soil consists of basalt lava flows with the potential of cracks, caves, and lava tubes (APTS, 2009a). However, visual observation did not reveal any deficiencies. The amount of surface lava is minimal. Based on well drilling reports, the site soil thickness is approximately 1.5 m (5 ft). Lava rock is encountered below this depth. Assuming the depth of soil is uniform, civil foundation and piping construction should not be hampered.

Land/Mineral Rights

The oil and gas industry is well established in the region of two of the evaluated sites, with producing oil and gas fields, support services, and compressor stations. Nearly all phases of oil and gas activities have occurred in the locality. These phases include seismic exploration, exploratory drilling, field well installation and operation. However, no gas and distillate wells are present on the proposed plant sites. The minerals (including oil and gas) beneath the sites evaluated are owned by the respective States. The mineral rights are leased to production companies for development. There were no stated mineral rights or commercial rights associated with the third candidate site evaluated (Thomas, 2008).

Aesthetics

Aesthetics is an important factor for consideration in selecting the site of the IIFP facilities. It is desirable to locate the IIFP facility in an area that is aesthetically pleasing, with visual appeal, where adjacent operations do not detract from the facility mission, and where state highways access adjoins the site. Satisfying these criteria can yield an IIFP facility that provides a positive public image and provides IIFP pride of ownership.

All sites exhibit a very nondescript appearance with open, vacant land. This is common for the areas of the three final candidate sites. Surrounding landscapes are similar in appearance. The only activities currently occurring at the two of the sites are cattle grazing and oil and gas production. Activity at the third site is primarily farming.

Land is readily accessible for the three of the sites evaluated with direct access from state highways to the sites. The selected Hobbs, New Mexico site has the preferred aesthetics. The Hobbs site has the option of selecting an ideal 242 ha (600 ac) location within 959 ha (2369 ac), an area with higher land value that has been developed for other industries, and has ready access to highways, airports, and utilities.

Licensing and Permits

In the community and state response packages from the final three candidate sites, no specific items that would cause licensing and permit issues were identified. There were 1) no non-attainment areas in the vicinity, 2) no aquatic or riparian habitat is situated within the sites, 3) no threatened or endangered species or their critical habitats were identified within the sites, 4) no historic, archaeological, and cultural sites were identified, 5) no known future projects for the site vicinity that could add additional impacts to constructing, operating and decommissioning the IIFP facility, 6) no legacy chemical or radiological contamination and 7) minimal environmental justice concerns.

However, in two of the candidate site areas, an evaluation is required of the impact of the threatened and endangered species identified as the Lesser Prairie Chicken that habitats the area. In addition, the sites required field walk-downs to ensure there are no historic, archaeological, and cultural sites.

2.2.1.3 Cost-Evaluation Results

Incentives

The incentives offered by two of the candidate sites were in the range of \$12-\$20 million. The third site had a lower incentive value due to the cost of acquiring land from a land owner and the absence of significant property tax savings.

Infrastructure Cost

Infrastructure includes the cost of land improvements and the cost for supplying water, electricity, natural gas, and sanitary waste treatment to the site. It also includes the cost for regulatory rigor associated with each site.

All three of the sites evaluated have adjacent access to state highway systems. Two of the sites have a Caliche rock layer that will have to be negotiated for civil construction work. The third site evaluated has a substantial soil layer before volcanic rock is encountered. The soil layer should accommodate civil construction at the site.

The Hobbs site is located over the Ogallala Aquifer, thus a well water supply is available approximately 61 m (200 ft) beneath the surface. Of the two other site evaluate, one had a plentiful well water supply and the other did not and water would have to be supplied from a city water supply several miles away and involving significant cost to pipe the water to the candidate site.

High voltage electrical transmission lines and natural gas lines cross the Hobbs site providing economical access. Provision of electrical power and natural gas to the other sites is costly since both must be routed several miles to the sites. There are no site differences in the cost of sanitary waste treatment systems since all sites must have an on-site sanitary waste treatment system.

Operating Costs

Operating costs were calculated based on the design life for the IIFP facility. The costs did not account for future year inflation nor was a discount rate used. The costs were developed to provide a general basis for use in site cost evaluations. There were no significant site differences in labor, water, or sanitary waste treatment costs. Electricity cost for the one site was the most costly at \$0.088 per kw-hr. The other sites had an electricity cost of about \$0.06 per kw-hr. Natural gas cost at the one site was the most costly at \$1.24 per Therm. The other sites had a natural gas cost of about \$1.00 per therm.

State and Local Taxes

State and local tax were calculated just to obtain a relative comparison of the sites and were based on a 20-year period of operations for the IIFP facility. The calculations were based on present values of IIFP facility revenue and income and did not account for future year inflation. The relative difference in the range of State and Local Taxes over the analysis period was only about \$5 million. The selected IIFP Hobbs, New Mexico site was in the middle of the range of the three sites evaluated.

Transportation Costs

Relative costs were developed for transport of DUF₆ cylinders by estimating the cost for shipments from (and return to) two of the potential enrichment plant suppliers (customers) of DUF₆ to each of the candidate sites. Costs were also developed for transporting oxide containers from each candidate site to a licensed disposal site in Utah and a potential future licensed disposal site in Texas.

Several cases were evaluated for a matrix of shipping and receiving scenarios. The transportation distance in miles was determined for each case. Transport costs of DUF₆ cylinders and oxide waste shipments were determined based on costs per mile and mileage in each of the cases. In all cases except Case 3, two of the sites evaluated; one of which was the selected Hobbs, NM site, have substantial cost savings over the third candidate site.

2.2.2 Final Site Selection

The sites were evaluated using the following procedure. The evaluation listed the Criteria, the Impact Value (range: 0 .05 Low Impact to 0 .8 High Impact) for each criteria, and the assigned Evaluation Value (Range: 1 Most Favorable to 10 Least Favorable) for each criteria. The Impact Value multiplied by the Evaluation Value provides the Score for each site's criteria. Thus, the site with the lowest Total Score (which was determined to be Hobbs, New Mexico) is the most beneficial site to select. The evaluation criteria for the site selection, the project objective, and the impact value for each criterion are listed in Table 2-4.

Based on the evaluation and a review of the seismic information, the Hobbs site has the most beneficial combination of attributes and economics that meet selection requirements identified in the IIFP Site Inquiry Package.

Table 2- 4 Evaluation Criteria for Site Selection

Evaluation Criteria	Project Objective	Impact Value
Local community residents must accept and support facility siting	Required	Pass/Fail
Local and state governments must support Regulatory Activities.	Required	Pass/Fail
Site cannot be in Seismic Zone 4.	Required	Pass/Fail
Site cannot be within 50 km of a quaternary active fault.	Required	Pass/Fail
Presence of nearby activities or structures that could be exposed to a hazard by the facility (NUREG 1513)	Regulatory	0.8
Presence of nearby activities or structures that could pose a hazard to the facility (NUREG 1513)	Regulatory	0.8
Commitment of natural resources for site offered including the destruction or diminution of wildlife habitats, flora, woodlands, and marshlands	Regulatory	0.8
Presence of endangered or threatened species, or critical habitat in <i>Endangered Species Act</i>	Regulatory	0.8
Environmental Justice Requirements (minority and low-income populations: multiple effects to be considered)	Regulatory	0.8
Will action cause a violation of Federal, State, local, <i>tribal laws</i> or requirements for protection of environment (Air Quality, Water Quality, other?)	Regulatory	0.8
Location of adjacent hazards or hazardous operations leading to cumulative impacts	Regulatory	0.8
State and local government financial incentives	Cost	0.4
Property tax incentive	Cost	0.8
State Income taxes	Cost	0.8
State Sales and use taxes	Cost	0.8
Transportation routes (impacts) for incoming feed material, considering distances & routes	Cost	0.8
Transportation cost to uranium oxide waste disposal site	Cost	0.8
Transportation cost to primary anhydrous HF buyers	Cost	0.8
Schedule time required to license and construct	Schedule	0.4
Existence of chemical or radiological contamination	Regulatory	0.4
Adequate water supply and cost	Cost	0.4
Presence of special interest groups (interveners)	Regulatory	0.4
Acreage Offered (min 640-acres) and cost	Cost	0.4
Waste types generated during construction, operation and demolition, RCRA, etc	Regulatory	0.4
Cost of construction and operation	Cost	0.4
Electrical supply and cost	Cost	0.4
Gas supply and cost	Cost	0.4
Impact on water quality or water supply (reduction)	Regulatory	0.4
Site characteristics: Geology, topography, seismic	Regulatory	0.2
Decommissioning Requirements	Regulatory	0.2
Site characteristics: depth to frost line	Regulatory	0.2
Infrastructure incentive	Cost	0.2
Contaminants	Regulatory	0.2
Training , accessibility, availability of emergency response personnel,	Regulatory	0.2

Evaluation Criteria	Project Objective	Impact Value
facilities		
Existing environmental data	Regulatory	0.2
Ambient noise levels	Regulatory	0.1
Site characteristics: climatology and meteorology	Regulatory	0.1
Sanitary wastewater treatment availability	Cost	0.1
Availability of road, rail, and airport	Cost	0.1
Buildings offered and terms	Cost	0.1
Condition of land	Cost	0.05
Unemployment insurance tax	Cost	0.05

Some of the primary benefits for the selection of the Hobbs site are as follows:

- The site has no constraining licensing or permitting issues including, 1) no apparent environmental justice concerns, 2) no legacy chemical or radiological contamination, 3) no threatened or endangered species, 4) no critical and important terrestrial habitats and 5) no air quality non-attainment areas in the vicinity.
- Public support including state and local officials for nuclear activities and the IIFP facility is excellent. Public participation meetings were well attended and comments were highly supportive.
- The site is not near an active fault and lies in a seismically quiet region.
- The land is readily accessible and is located in an area that is aesthetically pleasing. The location would present a positive public image and provide pride of ownership for IIFP.
- The site offers significant tax and land incentives.
- Utilities including electricity, water, and natural gas are available on the site. The Ogallala Aquifer lies beneath the site insuring a sufficient supply of water for plant operation.
- On site utilities offer infrastructure savings up to \$2 million relative to the other sites.
- U.S. 62/180 that serves the site is a well established radioactive waste transportation corridor established by DOE for shipping transuranic mixed waste.
- The site is sparsely populated with a few nearby ranches and a transient population associated with oil and gas exploration and production. However, there is a neighboring gas fired power plant with another utility and refinery close to the proposed site.
- Local colleges and universities have an existing training program in partnership with the National Enrichment Facility (NEF) centrifuge facility. These institutions have the capability and are committed to provide training to assure ample skilled labor for the construction and operation of the facilities. The Hobbs site could benefit by partnering with this existing program.
- A potential DUF₆ supplier (customer) is within 25 miles to the south of the site, and a potential licensed disposal site for RCRA hazardous waste is within 35 miles of the selected IIFP site.

2.3 No Action Alternative

The No-Action alternative would be to not construct, operate or decommission the proposed IIFP FEP/DUP facility in Lea County, New Mexico. The Lea County Proposed Action site would remain essentially in its current state or would be available for other uses. The overall “SMALL” impact of the Proposed Action and the “MODERATE” transportation and ecological impacts to specific wildlife travel corridors during construction of the Proposed Action would not occur. The Lea County regional communities and State would lose the tax and business revenues, otherwise generated by the Proposed

Action, and the approximate 150-250 construction and the estimated 120-160 facility operations new jobs and earnings would not materialize.

Under the No-Action alternative, the commercial uranium enrichment companies in the U.S. would likely have to rely on the Department of Energy to de-convert their DUF_6 in the DOE Paducah, Kentucky and/or the Piketon, Ohio de-conversion plants that are under construction. DOE presently has tens of thousands of depleted uranium hexafluoride cylinders in backlog and waiting for processing at the Paducah and Portsmouth gaseous diffusion sites (See Figure 2-13 and Figure 2-14). Owing to the huge stockpile and the original DOE mission for justification of government funding for the plants, it is expected the capacity of those plants will be fully scheduled in de-conversion of their own large stockpile. By some accounts, the processing of the present DOE inventory may require from 20 to 25 years, potentially leaving the private commercial sector without de-conversion services in the U.S during that time.

The No-Action alternative also negates the opportunity for using the fluoride value contained in the DUF_6 for production of useful and valuable commercial SiF_4 and BF_3 or other fluoride products.



Source: Energy Justice Network, 2009

Figure 2- 13 Paducah GDP with Thousands of UF_6 Cylinders Stored in Foreground



Source: Energy Justice Network, 2009

Figure 2- 14 UF₆ Cylinders Stored at the Portsmouth GDP

The DOE’s inventory of DUF₆ consists of approximately 700,000 metric tons of DUF₆. This inventory of DUF₆ is stored in about 57,000 steel cylinders (DOE, 2004a, DOE, 2004b). See Table 2-5, “DOE Inventory of Depleted UF₆.”

Table 2- 5 DOE Inventory of Depleted UF₆

Location	Total Cylinders	Total Depleted UF₆ (metric tons)
Paducah GDP, KY	36,191	436,400
Portsmouth GDP, OH	16,109	195,800
Oak Ridge, TN ¹	4,822	54,300
Total	57,122	686,500

¹Since the PEIS was published, the Oak Ridge cylinders were transferred to the Portsmouth GDP. Source: DOE, 2004a; DOE, 2004b

Additionally, new commercial enrichment facilities are under construction or are planned that will be generating additional DUF₆. Figure 2-15 shows the projection of the increasingly large accumulation of depleted DUF₆ that will be generated from new facilities (not including the existing Paducah Gaseous Diffusion Plant) in the U.S. over the next decade.

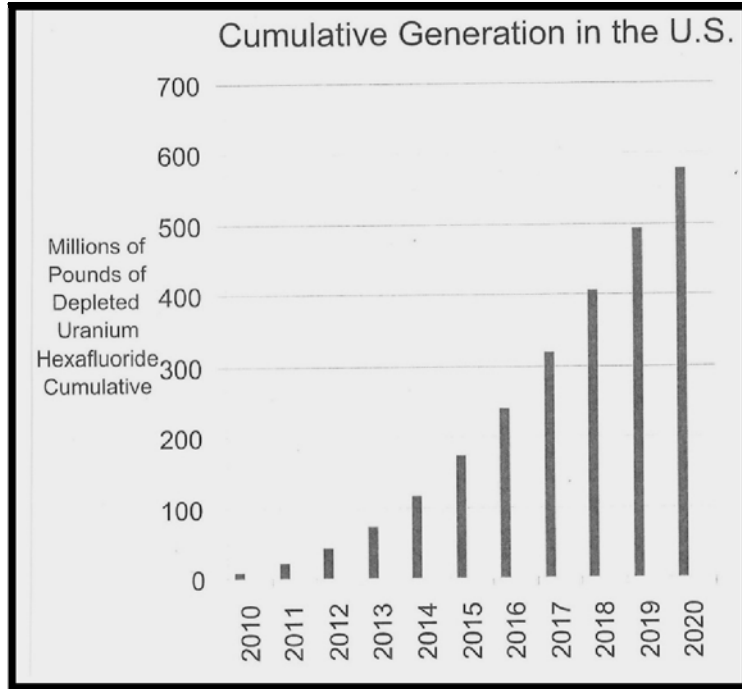

Figure 2- 15 Estimated DUF₆ Generated from New Enrichment Plants in the U.S.

The No-Action Alternative could potentially mean that the commercial private enrichment facilities may have to wait 20 to 25 years for DUF₆ de-conversion by the federal government; a long term delay with a potential unnecessary risk to the environment and the public. Under the No-Action Alternative, a decision by the NRC not to approve the IIFP license application would perpetuate the reliance on an over committed DOE de-conversion that has not yet demonstrated its operating capability.

2.4 Reasonable Alternative Actions

IIFP's Proposed Action is to use technologies for de-conversion of DUF₆ that produce marketable and valuable by-products including SiF₄, BF₃ and AHF.

Any Reasonable Alternatives for producing SiF₄, BF₃, or AHF, other than by utilization of the fluorine from DUF₆ de-conversion, were eliminated from further consideration. Alternatives are not considered because of the direct interrelationship of DUF₆ de-conversion and use of the fluorine value for producing AHF, BF₃ or SiF₄ in the Proposed Action. The No-Action and Reasonable Alternatives considered for de-conversion are the bounding cases.

2.4.1 Reasonable Alternative for De-conversion of DUF₆

There are basically two known commercial-scale chemical processes, other than the IIFP Proposed Action, for de-conversion of DUF₆. Both employ direct conversion of the DUF₆ to uranium oxide, as discussed below.

The de-conversion processes that will be utilized (currently under construction) at DOE sites located at Paducah, KY and Piketon, OH react DUF₆ with water (steam) and hydrogen to produce uranium oxides

(U₃O₈) and aqueous HF. Some of the process is proprietary, but generally the reaction of steam with UF₆ to produce uranium oxide is a well-known chemistry.

In the DOE process, the DUF₆ is directly converted to uranium oxide in a one-stage reaction vessel. HF and water vapor exit the reaction vessel and are collected as aqueous HF. The uranium oxide solids exit the reaction vessel, are temporarily stored and shipped to an approved waste disposal site. DOE plans to market the aqueous HF, but if unable to do so for all or part of the HF, then DOE may have to treat the HF as a waste liquid. This liquid waste would likely be reacted with lime to form calcium fluoride (CaF₂) for storing in retention basins, or selling in the market. (DOE, 2004a; DOE, 2004b). Assuming the CaF₂ can be sold, it could be used to produce AHF at an industrial AHF production plant. This method would be a very circuitous route to produce marketable AHF as compared with the IIFP Proposed Action, and the additional steps and processes are expected to have larger environmental impact than the Proposed Action.

The other known de-conversion process involves reacting DUF₆ directly with steam in a first-stage reaction vessel producing aqueous HF and depleted uranyl dioxyfluoride (DUO₂F₂). The DUO₂F₂ is further processed in a second-stage reaction vessel to form aqueous HF and depleted uranium oxide for disposal. This process is used in Europe for large-scale de-conversion of DUF₆. The HF is collected in aqueous form and either sold, if the market demands, and/or treated.

Other reasonable alternatives for de-conversion would include:

- Two of the enrichment companies have de-conversion facilities overseas and could choose to ship their DUF₆ from the U.S. to those facilities for de-conversion. In this alternative, two of the U.S. companies do not have existing overseas de-conversion facilities. Those companies that do have existing overseas facilities and technologies would be required to ship DUF₆ overseas long-distances and will have to return the waste oxides to United States for licensed disposal. The impacts at other locations are expected to be similar to the Proposed Action, and the transportation impact is expected to be significantly greater.
- Enrichment companies could decide to build and operate their own de-conversion facilities in the U.S. It is expected that the environmental impacts of the Alternative Action would be similar to the Proposed Action if those companies were to build new facilities to de-convert their own “tails” material.

2.5 Alternative Technology

In addition to the Reasonable Alternative technologies discussed above, IIFP considered the alternative action of building and operating only their “direct de-conversion to oxide process;” the Phase 2 plant. In this case, all of the fluoride value is utilized in the production of the AHF. The Proposed Action technology does not encounter the HF disposal uncertainties that are associated with a process where aqueous HF is the product, as for the reasons discussed in 2.4.1 above. The opportunity to produce highly valuable and pure fluoride products for use in important industries, such as semi-conductor and solar cell markets, would be foregone. The environmental impact of using only the Phase 2 plant direct oxide technology as compared to a Phase 1 FEP process plus a later Phase 2 process is expected to be essentially the same.

2.6 Cumulative Effects

Cumulative effects are those impacts that result from the incremental impact of an action added to other past, present, and reasonably foreseeable actions in the future. IIFP considered past, current and potential

facilities and activities that could have some potential or cumulative impacts. The future expansion to a Phase 2 facility projected for the 2015 timeframe and the potential approval by NRC to exempt some pre-license construction activities for the Proposed Action has already been included in this ER as reasonably foreseeable actions.

The anticipated impacts of the proposed construction and operation of the IIFP facility are expected to be minimal; thus any incremental accumulative impacts caused by IIFP should be inconsequential. The development and implementation of this Proposed Action and its technology potentially avoid impacts to other more environmentally sensitive sites.

Potential environmental impacts are assessed to be SMALL, except during construction periods when MODERATE impacts for transportation on local highways may occur and temporary disruptions occur in some wildlife travel corridors. Overall, the cumulative potential impacts are SMALL.

The cumulative collective radiological exposure to the off-site population will be well below the maximum dose limit of 100 mrem per year to the off-site Maximum Exposed Individual (MEI) and below the limit of 25 mrem/yr specified in 40 CFR 190 for uranium fuel cycle facilities. Annual individual doses to involved workers will be monitored and controlled to maintain exposure well below the regulatory limit of 5 rem per year.

The sum total of all local and non-local cumulative impacts and effects are expected to be insignificant when compared to the established federal, state and local regulatory limits. Positive cumulative effects include the expansion of job opportunities and local business and tax base revenues plus the Gross Revenue Tax and corporate income tax revenues to the State and regional communities.

2.7 Comparison of Predicted Environmental Impacts

2.7.1 Comparison of the Impacts of the No-Action Alternative and the Proposed Action

In the No-Action Alternative, the IIFP facility would not be built, operated or decommissioned. Any impact would thereby result from de-conversion of DUF₆ at the DOE facilities. The expected impact is summarized below based on the two Environmental Impact Statements (EIS) conducted by DOE.

In the two DOE Environmental Statements analyzing construction and operation of proposed UF₆ de-conversion facilities at DOE Paducah (DOE, 2004a), and DOE Portsmouth (DOE, 2004b), DOE found the environmental impacts associated with the Proposed Action alternatives would include (1) impacts to local air, water, soil, ecological, and cultural resources during de-conversion facility construction; (2) impacts to workers from facility construction and operations; (3) impacts from small amounts of DUF₆ and other hazardous compounds released to the environment through normal conversion plant air effluents; (4) impacts from the shipment of cylinders, conversion products, and waste products; and (5) impacts from potential accidents involving the release of radioactive material for or hazardous chemicals.

Additionally, DOE conducted another Environmental Assessment (Draft), Disposition of DOE Excess Depleted Uranium, Natural Uranium, and Low-Enriched Uranium, issued December 23, 2008. The No-Action Alternative for this Environmental Assessment (EA) (DOE, 2008) relative to DUF₆ is the status quo; that is, DOE would implement the currently planned operation of these two new facilities rather than implementing either of their Proposed Actions (DOE, 2008). Consequently, the operational impacts DOE assessed in its two DUF₆ de-conversion facility EISs (DOE 2004a, 2004b) are tantamount to the impacts of the No-Action Alternative for the IIFP FEP/De-conversion Facility assessed in this Environmental Report. If the IIFP facility was not constructed at Hobbs, LES would likely negotiate with DOE to

process their DUF₆. DOE would continue to operate the Paducah and Portsmouth de-conversion facilities and work in LES generated DUF₆. It is assumed that the operational throughput would remain the same based on the maximum operational limitations designed into the two facilities. Table 2-6 summarizes the generally minor operational impacts for DUF₆ de-conversion facilities assessed by DOE in the two de-conversion facility EISs (DOE, 2008).

2.7.1.1 Summary of Expected Impacts from Operation of the Paducah and the Portsmouth De-Conversion Facilities

In the context of impacts at enrichment facilities, DUF₆ feed is similar chemically and physically to normal uranium (NUF₆) feed. DUF₆ feed would have slightly lower radiological hazard than NUF₆ feed because of decreased U-234 and U-235. Given equal amounts of DUF₆ or NUF₆ feed, there would also be a slightly lesser amount of DUF₆ tails with an assay of 0.20% than DUF₆ tails with an assay of 0.35%. In addition, DUF₆ tails with an assay of 0.20% would have a slightly lower radiological hazard than DUF₆ tails with an assay of 0.35% because of the decreased U²³⁴. Enrichment activities would also take place within the NRC-licensed capacities at the enrichment facilities. Therefore, DOE has determined that the impacts of enriching DUF₆ tails would be similar to or slightly less than the impacts of enriching NUF₆. In the context of impacts at de-conversion facilities, DUF₆ tails with an assay of 0.20% would have a slightly lower radiological hazard than DUF₆ tails with an assay of 0.35%, again because of decreased U²³⁴. In addition, given equal amounts of feed, there would also be a slightly lesser amount of DUF₆ tails with an assay of 0.20% than DUF₆ tails with an assay of 0.35%. Therefore, DOE has determined that the impacts of converting DUF₆ tails with an assay of 0.20% would be similar to or slightly less than the impacts of converting DUF₆ tails with an assay of 0.35%.

At the Portsmouth de-conversion facility, the number of DUF₆ cylinders could increase slightly, from 20,931 to 21,086 (0.7%), as a result of the DOE proposed action in draft EA (DOE, 2008). At the Paducah de-conversion facility, the number of DUF₆ cylinders could also increase slightly, from 41,013 to 41,168 (0.4%), as a result of the Proposed Action of the referenced draft EA. The impacts from these incremental changes would be minor.

2.7.1.2 Environmental Impacts from Transportation of Radioactive Material

Under the No-Action Alternative, the IIFP facility is not constructed; uranium enrichment facilities (except in the case of the Paducah Gaseous Diffusion Plant) would need to ship the DUF₆ cylinders to the Paducah and Portsmouth De-conversion Facilities or to other de-conversion facilities overseas. DOE (2004a, 2004b) evaluated the radiological consequences of a severe transportation accident involving DUF₆. These accidents are characterized by extreme mechanical and thermal forces, and accidents of this severity would be expected to be extremely rare (Biwer et al., 2001). Because DOE postulated a hypothetical accident that could occur at any location, the results are not route-dependent. DOE evaluated

Table 2- 6 Summary of Expected Impacts from Operation of the Paducah and Portsmouth De-Conversion Facilities

Resource Area	Impact
Human Health and Safety Normal Operations	The estimated potential exposures of workers and members of the public to radiation and chemicals would be well within applicable public health standards and regulations during normal facility operations. The estimated doses and risks from radiation and/or chemical exposures of the public and uninvolved workers would be very low, with zero Latent Cancer Fatalities (LCF) expected among these groups over the time periods considered, and with minimal adverse health impacts from chemical exposures expected.

Resource Area	Impact
Human Health and Safety Facility Accidents	Workers could be injured as a result of operational accidents unrelated to radiation or chemical exposure. About 8 injuries per year during operations could occur. It is possible that accidents could release radiation or chemicals to the environment, potentially affecting both the workers and members of the general public. Of all the accidents considered, those involving DUF ₆ cylinders and those involving chemicals at the conversion facilities would have the largest potential effects.
Human Health and Safety Transportation	During normal transportation operations, radioactive material and chemicals would be contained within their transport packages. Health impacts to crew members (i.e., workers) and the members of the public along the routes could occur if they were exposed to low-level external radiation in the vicinity of uranium material shipments. In addition, exposure to vehicle emissions (engine exhaust and fugitive dust) could potentially cause latent fatalities from inhalation. Traffic accidents could occur during the transportation of radioactive materials and chemicals. These accidents could potentially affect the health of workers (i.e., crew members) and members of the public, either from the accident itself or from accidental releases of radioactive materials or chemicals. The total number of traffic fatalities (unrelated to the type of cargo) was estimated on the basis of national traffic statistics on shipments by both truck and rail. If the aqueous HF was sold, about 1 traffic fatality would be estimated under both transportation modes. If HF were neutralized to calcium fluoride (CaF ₂), about 2 fatalities would be estimated for the truck option and 1 fatality for the rail option. Severe transportation accidents could also result in a release of radioactive material or chemicals from a shipment. The consequences of such a release would depend on the material released, location of the accident, and the atmospheric conditions at the time. Potential consequences would be greatest in urban areas because more people could be exposed.
Air Quality and Noise	During operations, it is estimated that total concentrations for all criteria pollutants (except for PM _{2.5}) would be well within standards. The background level of annual average PM _{2.5} in the areas of both sites approaches or exceeds the standard. The total concentrations of VOCs, uranium, and fluoride would also be well below applicable standards. Estimated operational noise levels at the nearest residence would be below the EPA guideline of 55 A-weighted decibels (dB [A]) as day-night average sound level for residential zones.
Water and Soil	No appreciable impacts on surface water, groundwater, or soil conversion facilities because no contaminated liquid effluents are anticipated and because airborne emissions would be very low levels (e.g., <0.25 grams per year of uranium).
Ecological	Concentrations of contaminants in the environment during operations would be below harmful levels. Impacts to vegetation and wildlife would be negligible.
Waste Management	Waste generated during operations would have negligible impacts on the waste management operations at both sites, with the exception of possible impacts from disposal of CaF ₂ . Industrial experiences indicate that HF, if produced, would contain only trace amounts of DUF ₆ (less than 1 part per million). It is expected that HF would be sold for use. If sold, the sale would be subject to review and approval by DOE in coordination with the NRC, depending on the specific use.
Resource Requirements	Resource requirements include construction materials, fuel, electricity, process chemicals, and containers. In general, there would be a negligible effect on the local or national availability of these resources.
Land Use	Negligible.
Cultural	None.

Resource Area	Impact
Socio-economics	An estimated 150 jobs would be generated during construction of the cylinder yard, and an estimated 280 jobs would be generated during construction of the conversion facility. There would be an approximate 0.1% annual growth in jobs. With limited immigration of population expected, there would be a marginal impact on local housing, public financing, or local service employment.
Environmental Justice	No disproportionately high and adverse human health or environmental impacts are expected to minority or low-income populations.
Decontamination & Decommissioning (D&D) Activities	D&D impacts to involved workers would be primarily from external radiation; expected exposures would be a small fraction of operational doses; no LCFs would be expected. It is estimated that no fatalities and up to five injuries would result from occupational accidents. Impacts from waste management would include a total generation of about 275 cubic yards (210 cubic meters) of Low Level Waste (LLW), 157 cubic yards (120 meters) of Low Level Mixed Waste, and 157 cubic yards (120 cubic meters) of hazardous waste; these volumes would result in low impacts compared with projected site annual generation volumes.
Cumulative Impacts	<p>The cumulative collective radiological exposure to the off-site population would be well below the maximum DOE dose limit of 100 mrem per year to the off-site MEI and below the limit of 25 mrem/yr specified in 40 CFR 190 for uranium fuel cycle facilities. Annual individual doses to involved workers would be monitored to maintain exposure below the regulatory limit of 5 rem per year.</p> <ul style="list-style-type: none"> • At Paducah, up to 6,000 rail shipments and 18,600 truck shipments of radioactive material could occur. The cumulative maximum dose to the MEI along the transportation route near the site entrance would be less than 1 mrem per year under all transportation modes. At Portsmouth, up to 6,800 rail shipments and 12,300 truck shipments of radioactive material could occur. The cumulative maximum dose to the MEI along the transportation route near the site entrance would be less than 1 mrem per year under for all transportation modes. • The sites are located in attainment regions. However, the background annual-average PM_{2.5} concentration is near (for Paducah) or exceeds (for Portsmouth) the regulatory standard. Cumulative impacts would not affect attainment status. • Data from the 2000 annual groundwater monitoring showed that four pollutants (for Paducah) and five (for Portsmouth) exceeded primary drinking water regulation levels in groundwater. Good engineering and construction practices should ensure that indirect cumulative impacts on groundwater associated with the conversion facilities would be minimal. • Cumulative ecological impacts on habitats and biotic communities, including wetlands, would be negligible to minor. • Cumulative land use impacts are anticipated to be negligible to minor. • Given the absence of high and adverse cumulative impacts for any impact area considered, no environmental justice cumulative impacts are anticipated despite the presence of low-income populations in the vicinity of both sites. • Socioeconomic impacts under all alternatives considered are anticipated to be generally positive, often temporary, and relatively small.

Sources: DOE 2004a, 2004b

PM_{2.5} = particulate matter with a diameter of 2.5 microns or less; PM₁₀ = particulate matter with a diameter of 10 microns or less.

the radiological consequences to people in rural areas (6 persons per square kilometer [15 persons per square mile]), suburban areas (719 persons per square kilometer [1,798 persons per square mile]), and

urban areas (1,600 persons per square kilometer [4,000 persons per square mile]). Radiation doses were estimated under neutral atmospheric conditions (Stability Class D with a wind speed of 14 kilometers [9 miles] per hour) and stable atmospheric conditions (Stability Class F with a wind speed of 3.5 kilometers [2.2 miles] per hour). See ER Section 4.2.6.4 Environmental Impacts from Transportation of Radioactive Material.

Additionally, the NRC has evaluated the environmental impacts resulting from the transport of nuclear materials in NUREG-0170, “Final Environmental Statement on the Transportation of Radioactive Material by Air and Other Modes” (NRC, 1977a), and updated by NUREG/CR-4829, “Shipping Container Response to Severe Highway and Railway Accident Conditions” (NRC, 1987a). These references include accident scenarios related to the transportation of radioactive material. The NRC found that these accidents have no significant environmental impacts (NRC, 1977a; NRC 1987a).

2.7.2 Comparison of the Impacts of the Reasonable Alternatives and the Proposed Action

Scenarios are discussed below for the Reasonable Alternative Actions against the potential impacts for the Proposed Action for Chapter 4 environmental categories in relative terms, i.e., impacts are the same, greater than, or less than those anticipated for the Proposed Action. Chapter 4 contains the detailed description of potential impacts of the Proposed Action on individual resources of the affected environment.

Other reasonable alternatives for de-conversion would include either shipping material overseas for de-conversion, constructing their own de-conversion facility in the U.S., or utilizing the DOE facilities with increased capacity. The following paragraphs discuss both of these reasonable alternatives:

2.7.2.1 Shipping Material Overseas for De-Conversion

Two of the enrichment companies have de-conversion facilities overseas and could choose to ship their DUF₆ from the U.S. to those facilities for de-conversion. In this alternative, two of the U.S. companies do not have existing overseas de-conversion facilities. Those companies that do have existing overseas facilities and technologies would be required to ship DUF₆ overseas long-distances and may have to return the waste oxides to United States for licensed disposal or may have to arrange with other countries for disposal. The impacts at other locations are expected to be similar to the Proposed Action, and the transportation impact is expected to be significantly greater.

The environmental impacts for the Reasonable Alternatives for shipping DUF₆ overseas to enrichment companies’ de-conversion facilities:

- The environmental impacts for shipping DUF₆ tails overseas are expected to be significantly greater for Transportation than for the Proposed Action.
- The environmental impacts of shipping the DUF₆ overseas may be greater in Waste Management and potential Land Use greater than the Proposed Action, if aqueous HF generated by this alternative is not marketable or sold. This potentially greater impact is due to the difference in technologies that produce HF, and in the case of aqueous HF, results in the treatment and generation of CaF₂ waste, if that solid waste cannot be sold.
- The environmental impacts of this Reasonable Alternative are expected to be similar to the Proposed Action for all other resources if the enrichment companies have to build new capacity. The environmental impacts of the Reasonable Alternative could be less if the enrichment companies have excess de-conversion capacity in their existing facilities, up until the time that capacity is fully utilized, and new capacity has to be constructed.

2.7.2.2 Enrichment Companies Constructing Their Own De-conversion Facilities

Enrichment companies could decide to build and operate their own de-conversion facilities in the U.S. It is expected that the environmental impacts of the Alternative Action would be similar to the Proposed Action if those companies were to build new facilities to de-convert “tails” material.

The environmental impacts for the Reasonable Alternative of enrichment companies building and operating their de-conversion facilities in the U.S.:

- The environmental impacts for this Reasonable Alternative in Waste Management and potential Land Use are expected to be greater than the Proposed Action, if aqueous HF generated by this alternative is not marketable or sold. This potentially greater impact is due to the difference in technologies that produce HF, and in the case of aqueous HF, results in the treatment and generation of CaF₂ waste, if that solid waste cannot be sold.
- The environmental impacts for this Reasonable Alternative are expected to be similar to the Proposed Action for all other resources.

2.7.2.3 Utilizing the DOE Facilities with Installation of Additional Capacity

The environmental impacts for the Reasonable Alternative for utilizing existing DOE de-conversion facilities with construction of additional capacity:

- The environmental impacts for this Reasonable Alternative in Waste Management and potential Land Use is expected to be greater than the Proposed Action, if aqueous HF generated by this alternative is not marketable or sold. This potentially greater impact is due to the difference in technologies that produce HF, and in the case of aqueous HF, results in the treatment and generation of CaF₂ waste, if that solid waste cannot be sold.
- The environmental impacts for this Reasonable Alternative for all other resources is expected to be equal to or slightly less than the Proposed Action, owing to some infrastructure already in place and not having to be constructed at the existing DOE facilities.

The demand for aqueous HF generated by the DOE and European processes is of lesser economic value and demand than that of anhydrous HF generated in the IIFP Proposed Action (Hartmann et. al., 2001). If the aqueous HF generated by a de-conversion process is not marketable, then treatment could potentially introduce a relatively large environmental impact. For example, in de-conversion processes that generate aqueous HF as a by-product and where it may have to be treated, the amount of calcium fluoride produced by lime treatment is about 0.7 pounds of CaF₂ for each pound of DUF₆ de-converted. The Reasonable Alternative actions involve essentially the same major hazardous chemicals, DUF₆ and HF, as do the Proposed Action for de-conversion of DUF₆, with respect to potential environmental impact. The alternative actions, as well as the Proposed Action, generate depleted uranium oxide as the ultimate radioactive waste for disposal. The Proposed Action does produce AHF that has a lower vaporization (boiling point) than aqueous HF. The Proposed Action provides secondary-type containment and/or significant safety controls where AHF is produced, stored or transferred.

The Proposed Action would be a complementary and competitive supplier for uranium de-conversion service and provide a means in the near term for stable disposal of depleted UF₆ that is projected to be increasingly generated in the private sector.

3. DESCRIPTION OF THE ENVIRONMENT AFFECTED

This Chapter describes the regional and local environmental characteristics at the proposed International Isotopes Fluorine Products (IIFP) 640-acre Section. This Chapter presents information on land use, transportation, geology and soils, water resources, ecological resources, meteorology, climatology, air quality, noise, historic and cultural resources, visual/scenic resources, socioeconomic, public and occupational health, and waste management.

The proposed IIFP 640-acre Section is located in southeastern New Mexico in Lea County, approximately 22.5 km (14 mi) west of Hobbs, New Mexico. The proposed 640-acre Section is approximately 27.4 km (17 mi) from the Texas/New Mexico border, and 362 km (225 mi) southeast of Albuquerque, New Mexico. See Figure 3-1, “Lea County New Mexico.”

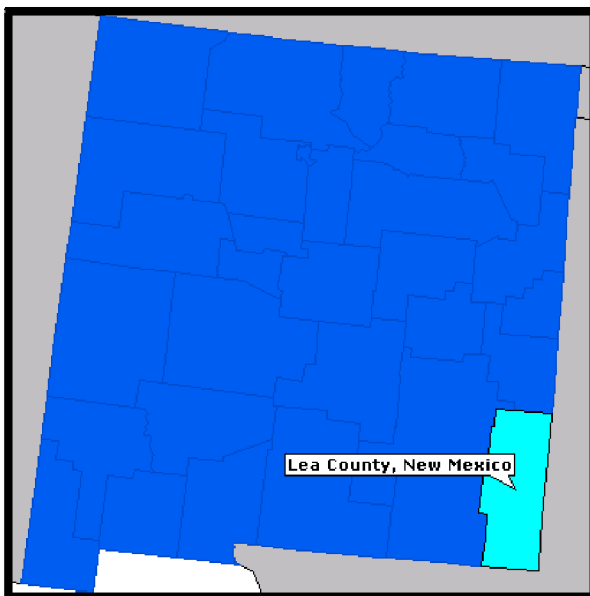

Figure 3- 1 Lea County New Mexico

The IIFP 640-acre Section is currently owned by the State of New Mexico. It is being transferred to Lea County and then will be transferred to International Isotopes, Inc. (INIS) for use in construction of this project. The transfer process is expected to be completed by the end of 2009. In the interim, the State of New Mexico has granted a 6-month right of access to the property. (EDCLC, 2008). The proposed IIFP 640-acre Section consists of mostly undeveloped land that had used for cattle grazing and for gas and oil production.

3.1 Land Use

This section describes land uses in Lea County near the proposed IIFP site. It also provides a discussion of off-site areas and the regional setting and includes a map of major land use areas.

3.1.1 Land Use Status

Lea County is approximately 2.8 million acres in size. Property ownership is 17% federal government, 31% state government, and 52% private. The federally owned land is primarily located in the southwestern portion of the county, the state-owned land is predominately located throughout the middle, and the privately owned land primarily extends from north to south in the county's eastern portion. Large tracts of land in Lea County are privately owned by farmers, ranchers, oil, gas, and mining companies. Urbanized areas near cities and towns include ownership of smaller tracts of land for residential, municipal, and commercial purposes. Approximately 93% of Lea County is used as range land for grazing, and approximately 4% is used for crop farming. Urban areas and the roadway system account for the remaining land use. Most of the land actively farmed in Lea County is irrigated (LCWUA, 1998).

The proposed IIFP site is situated within Lea County, on the north side of U.S. Highways 62/180 (U.S. 62/180) and on the east side of New Mexico Highway 483 (NM 483), about 27.4 km (17 mi) west of the New Mexico/Texas state line. The site is currently undeveloped and utilized for small oil and gas well tanks/structures. Several overhead power lines and underground power lines run generally east to west, and several pipelines run north and west as well as east to west. Surrounding land is used by industrial facilities, oil and gas production, and cattle grazing. See Figure 3-2, "Land Status for the Area Around the Proposed IIFP Site."

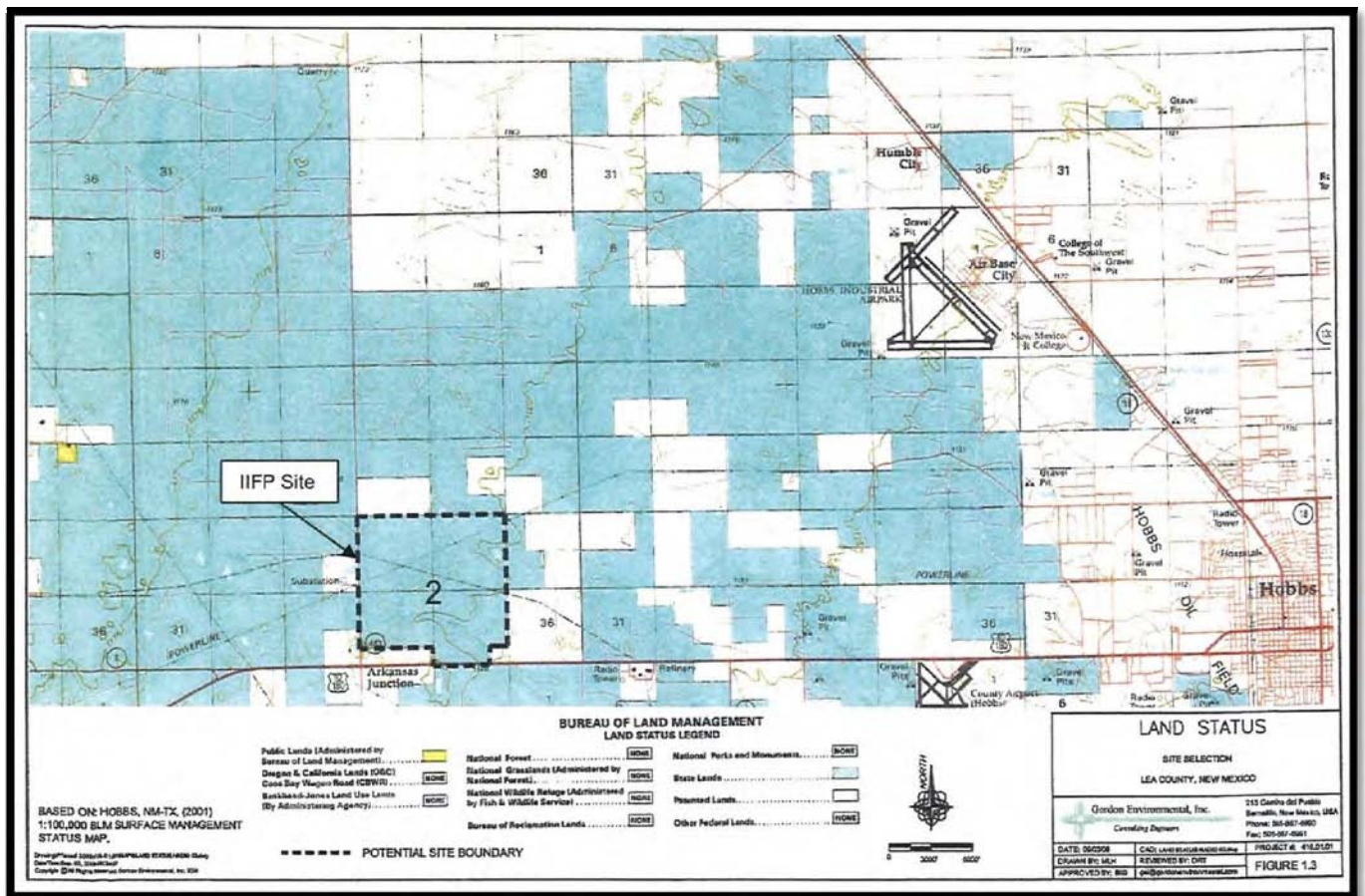

Source: EDCLC, 2008

Figure 3- 2 Land Status for the Area around the Proposed IIFP Site

Site soils consist of fine sand and loamy fine sand with a well-developed Caliche layer occurring at the surface or as shallow as 25.4 to 30.5 cm (10 to 12 in) below the surface in some areas of the site. On-site soils are common to areas used for rangeland and wildlife habitat. Land use within the proposed site for the IIFP facility is referred to a Mixed Rangeland with some Herbaceous Rangeland along the western boundary. There are two small areas immediately outside the site boundaries classified as cropland and pasture. One small section immediately to the west of the site is classified as industrial. No special land use classifications (i.e., Native American reservations, national parks, prime farmland) are within the vicinity of the site.

Although various crops are grown within Lea County, there is no current agricultural activity in the IIFP site vicinity, except for domestic livestock ranching. The principal livestock for Lea County is cattle. Dairy cattle comprise a significant number of cattle in Lea County. The number of farms decreased 19% within Lea County between 1997 and 2002, while the land in farms increased by 12%. The average size of the farm increased 38% to 4,076 acres between 1997 and 2002 (USDA, 2002a). However, the number of farms increased only 3% from 2002 to 2007. Over 2.36 million acres are being farmed in 2007 with the average size of the farm at 4,135 acres, an increase of 1% from 2002 (USDA, 2007).

Surface drainage at the site is contained within a few, intermittent local playas that have no external drainage. Runoff does not drain to one of the state's major rivers. Surface water is lost through evaporation, resulting in high salinity conditions in both the waters and soils associated with the playas. These conditions are not favorable for the development of viable aquatic or riparian habitats. There is also a small stream that runs from the northwest to the southeast across the property that is predominantly dry during the year. See Figure 3-3 which is a topographic map of the proposed IIFP site which shows the low terrain where the stream and playas are located during periods of rain. There is no designated Federal Emergency Management Agency (FEMA) Zone A area at the IIFP location that would be inundated during a 100-year flood event. Refer to Figure 3-27, "Watercourses, Floodplains, and Playas Map."

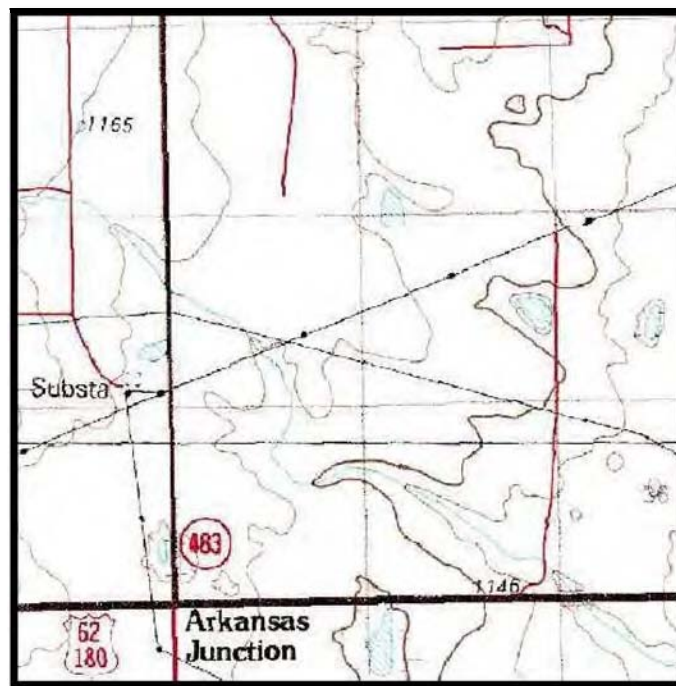

Source: U.S. Geological Survey

Figure 3- 3 Topographic Map of the Proposed IIFP Site

3.1.2 Description of Off-site Areas

Property surrounding the IIFP site consists of vacant land and four power and gas industry plants. See Figure 3-4, “Industries Located Around the International Isotopes Site.” Tentatively, Section 27 of 18S Township, 37E Range has been selected for the approximately 40 acres (Site marked within Section 27) to be carved from the 958.7-hectare (2,369-ac) Section. Section 26 (east of the marked International Isotopes section), Section 34 (south of the Section 27), Section 34 (south) and Section 35 (southeastern block) are still possibilities for the selection. The Xcel Energy Cunningham Generation Station (Figure 3-5) is on the west boundary (NM 483) of the IIFP proposed property line. The tentative location of the IIFP plant is 1 km (0.6 mi) from the Xcel Cunningham Station power plant. Cunningham Station is a four-unit, natural gas-fueled station. The first two units installed were steam turbine units; while the second two units were combustion turbine units. Total power production capacity for the four units is 487 megawatts (MW). Cunningham Station is a zero discharge plant; no process waters are discharged from the plant site. Cooling water from the Cunningham station is reused to irrigate nearby pecan tree orchards (Xcel, 2009a).



Source: EDCLC, 2009a

Figure 3- 4 Industries Located Around the International Isotopes Site



Figure 3- 5 Power Plant Located Across Highway NM 483 from IIFP Facility

Xcel Energy Maddox Station (Figure 3-6) is located 3.7 km (2.3 mi) ESE from the center of the proposed IIFP plant. Maddox Station's Unit 1 is a natural gas-fired, steam-electric generating unit, and units 2 and 3 are natural gas combustion turbines. The three units have a combined generation capacity of 192 MW. In 2008, Maddox Station installed a surface-lined disposal pool for irrigation to land and crops (Xcel, 2009b).

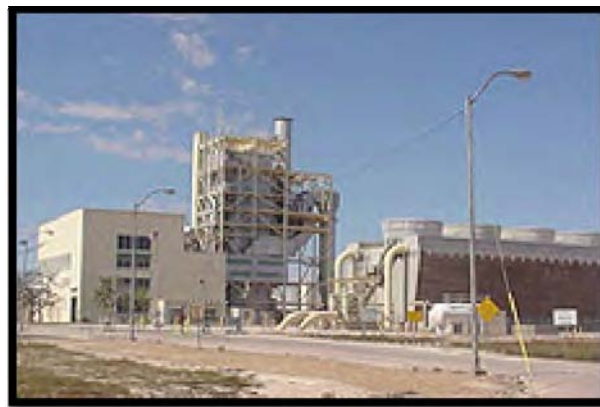

Figure 3- 6 Xcel Energy Maddox Station East of the IIFP Facility

A new power plant, Colorado Energy Station (Figure 3-7) was built in 2008. It is built approximately 2.4 km (1.5 mi) northeast of the center of the IIFP facility. Major components were obtained from two power plant projects abandoned in Tennessee and Mississippi due to the lack of long-term power purchase agreements. The project is also unique because it includes an air-cooled condenser as opposed to the more traditional cooling tower and water-cooled condenser. Combined-cycle technology employs both a gas combustion turbine and a steam-driven turbine to gain maximum efficiency. The waste heat from two combustion turbines feeds into boilers, producing steam to drive an additional steam turbine. The capacity for this station is projected at a nominal 550 MW (Colorado Energy, 2009).

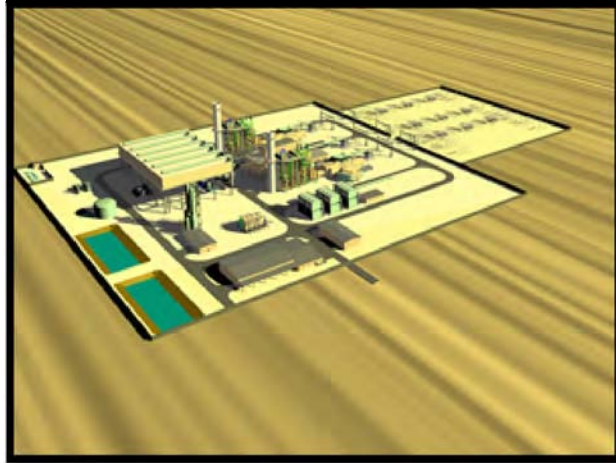

Figure 3- 7 Colorado Energy Station Northeast of the IIFP Facility

DCP Midstream Linam Ranch Plant, a natural gas processing facility, is located 5 km (3.1 mi) southeast of the IIFP site (Figure 3-8). Modifications at the Linam Ranch gas plant were completed in late 1995 to improve operations and reap higher Natural Gas Liquid (NGL) recovery, to increase reliability, and to increase the capacity to 150 millions of cubic feet per day. The Linam Ranch Plant was converted from a propane refrigerated lean-oil absorption plant to a cryogenic operation with modern turbine compression (DCP, 2009).



Figure 3- 8 DCP Midstream Linam Ranch Plant Southeast of the IIFP Facility

The nearest known residence to IIFP is situated northeast of the site 8.5 km (5.3 mi) from the northern boundary fence. There are no known public recreational areas within 8 km (5 mi) of the site. Transportation corridors are discussed in ER Section 3.2, “Transportation.” A discussion of schools and hospitals is included in ER Section 3.10, “Socioeconomic.”

3.1.3 Mineral Resources

Large active oil and gas fields have existed in Lea County for more than 50 years. The New Mexico portion of the Permian Basin contains 1,112 designated, discovered oil reservoirs and 672 designated, discovered gas reservoirs. Mined potash and gypsum deposits are located in the southern portions of Lea County. Both have played major economic roles since their discovery. Other natural resources include sand and gravel, cultural resources, and other minerals (LCWUA, 1998).

New Mexico has averaged 225 registered active mining operations in recent years. In 2007, New Mexico had 242 active registered mining operations. These operations included five coal mines; three potash mines and five potash refineries' one molybdenum mine and one molybdenum mill; two copper mines, one copper concentrator and two solvent extraction/electro-winning plants; 20 industrial mineral mines and 18 industrial mineral mills; and 184 stone and aggregate operations. Those mines/mining operations are shown in Figure 3-9.

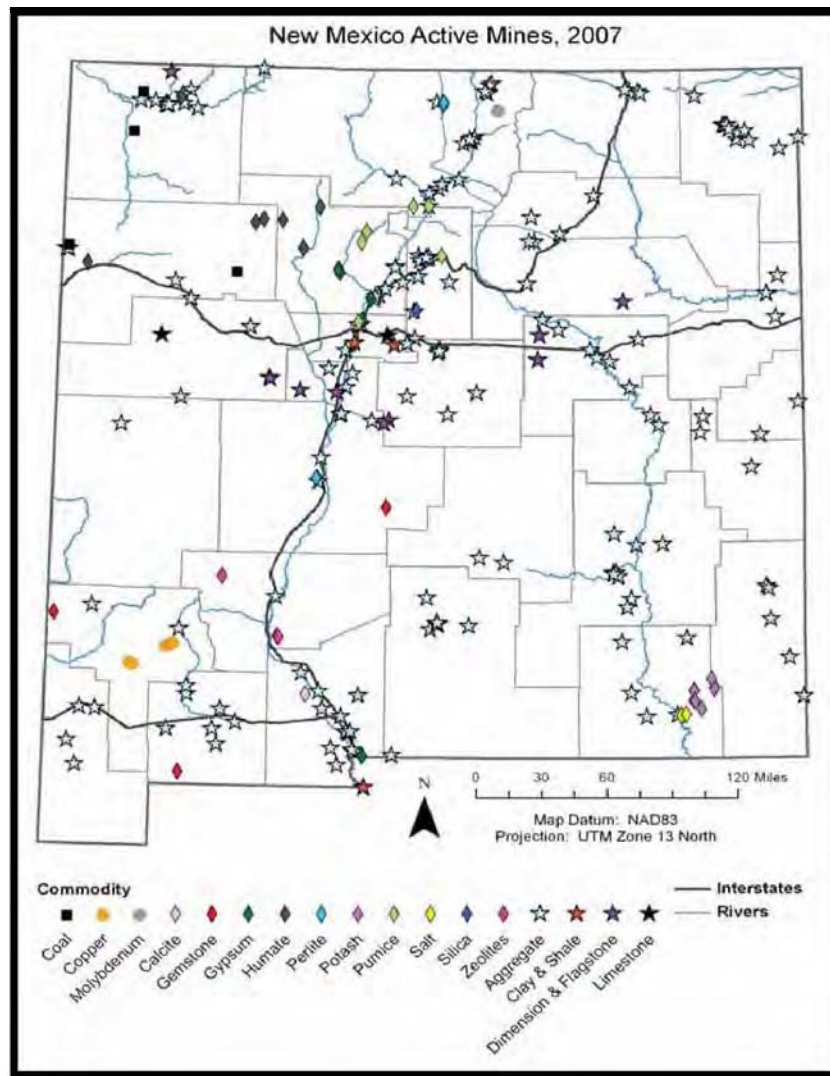

Source: NMEM&NRD, 2008

Figure 3- 9 New Mexico Active Mines, 2007

Over \$2.2 billion worth of minerals were extracted in New Mexico during 2007, exceeding the \$2.1 billion production record value of 2006. See Figure 3-10, “New Mexico Mineral Production Value and Revenue Generated, 1989-2007.” Higher commodity prices and increased production quantities have driven a 77.7% increase in mineral production values between 2000 and 2007. New Mexico remains a leading

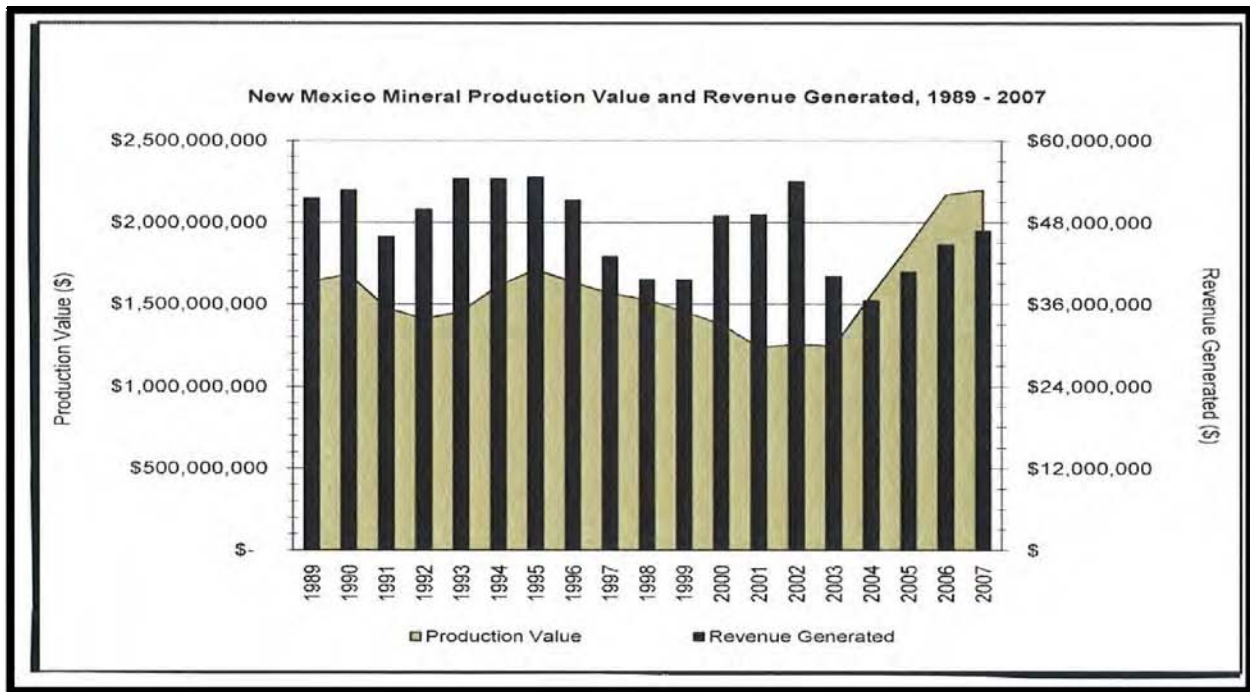

Source: NMEM&NRD, 2008

Figure 3- 10 New Mexico Mineral Production Value and Revenue Generated, 1989-2007

U.S. mineral producer, ranked first in potash, perlite and zeolite; third in copper; sixth in molybdenum; ninth in gold; tenth in silver; and thirteenth in coal production. New Mexico produced 2.23 % of the U.S. total non-energy minerals production value. The principal minerals, in descending order of value, are copper, coal, potash, aggregates, and molybdenum.

Figure 3-11 shows the percentage of production value, employment, payroll, and revenue by commodity for 2007. Copper overtook coal as New Mexico’s leading commodity for production value and continued its recent trend of increased employment numbers and payroll. Coal remained the leading commodity for revenue generation and payroll. Copper, molybdenum and aggregates all set record production value records. Industrial mineral production is directly related to demand for construction-related products.

3.1.4 Unusual Animals

Wildlife common to the area near the subject site includes quail, owls, turtles, white tail and jack rabbits, horny toads, javelins, coyotes, fox and mule deer. A nomination has been submitted by numerous petitioners to the Bureau of Land Management (BLM) to designate two public land parcels within Lea County as an Area of Critical Environmental Concern (ACEC) for the lesser prairie chicken. These parcels do not include the Proposed IIFP Site. Currently, the BLM is evaluating this nomination and expects to make a decision within the next several years (Stinnett, 2002). The sand dune lizard is

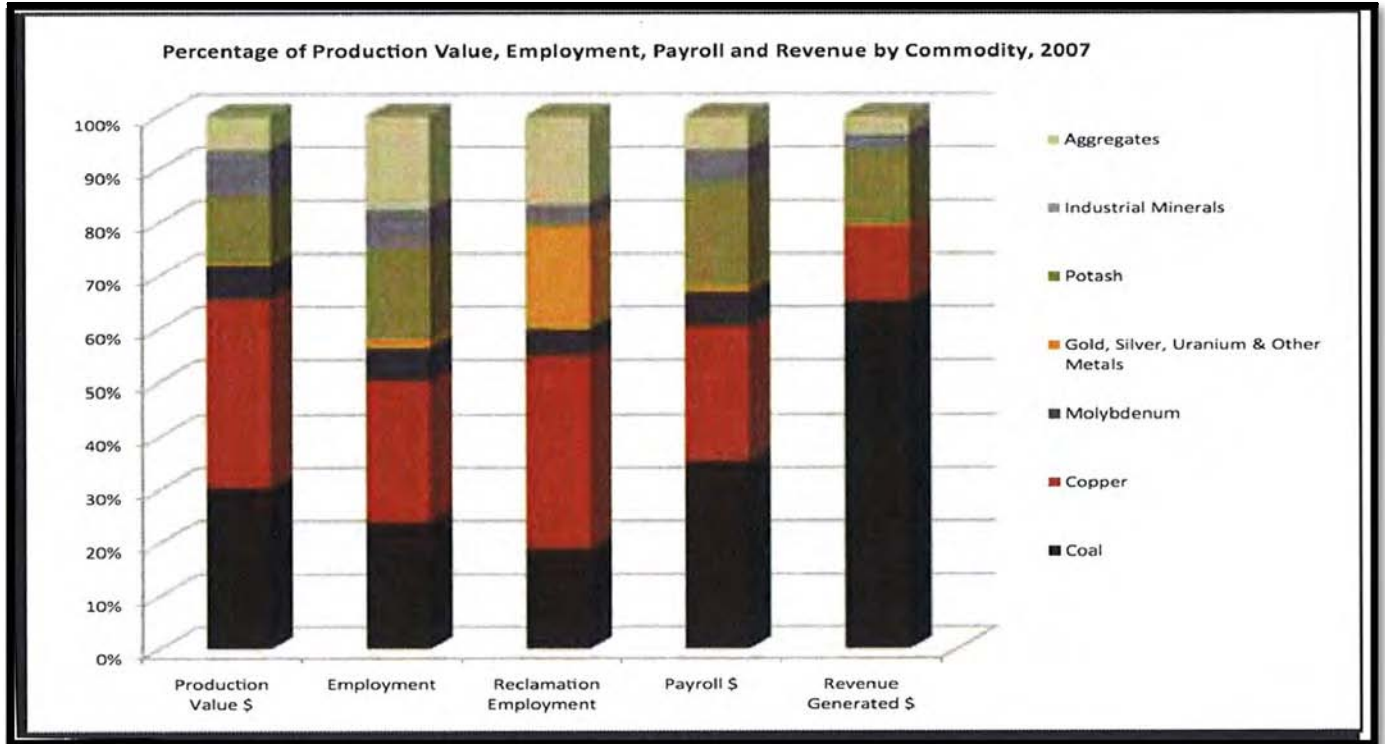

Source: NMEM&NRD, 2008

Figure 3- 11 Percentage of Production Value, Employment, Payroll and Revenue by Commodity, 2007

currently listed as a candidate species on the federal listing as threatened on the New Mexico State Threatened and Endangered list. The northern aplomado falcon and the black-footed ferret are listed as endangered by the U.S. Fish and Wildlife Services. Eight species are listed as a species of concern under the *Endangered Species Act* by the U.S. Fish and Wildlife Service (USFWS, 2009a). See ER Section 3.5, “Ecological Resources,” for a discussion of unusual animals that may be found near the site.

Except for the proposed construction of the IIFP plant, there are no other known current, future or proposed land use plans for the site. Because the site is not subject to local or county zoning, land use planning, or associated review process requirements, there are no known potential conflicts of land use.

3.2 Transportation

This section describes transportation facilities at or near the IIFP site. The section provides input to various other sections such as 3.11, “Public and Occupational Health,” and 3.12, “Waste Management,” and includes information on access to and from the plant, proposed transportation routes, and applicable restrictions.

3.2.1 Access Transportation

The proposed IIFP site lies along the north side of U.S. 62/180 and the east side of NM 483 at Arkansas Junction. U.S. 62/180 intersects NM 18 providing access from the city of Hobbs south to Eunice and Jal. New Mexico 132 runs north from Hobbs at the intersection with U.S. 62/180 to Knowles and Denver City. U.S. 62/180 runs southwest to Carlsbad, New Mexico, approximately 80 km (50 mi) from the

proposed site. U.S. 62/180 runs east through Seminole, Texas [48 km (30 mi) from Hobbs] to Forth Worth, Texas, 547 km (340 mi) from the site. Refer to Figure 3-12, “Transportation Infrastructure for Southeastern New Mexico,” which shows the cities and roads around the site in southeastern New Mexico and northwestern Texas. Population centers around the proposed location are at distances from the site as follows:

- Hobbs, Lea County, New Mexico: 23 km (14 mi) east
- Eunice, Lea County, New Mexico: 27 km (17 mi) south
- Jal, Lea County, New Mexico: 56 km (35 mi) south
- Lovington, Lea County, New Mexico: 33 km (20 mi) north-northwest
- Seminole, Gaines County, Texas: 48 km (30 mi) east
- Denver City, Gaines County, Texas: 54 km (33 mi) north-northeast
- Andrews, Andrews County, Texas: 70 km (43 mi) southeast

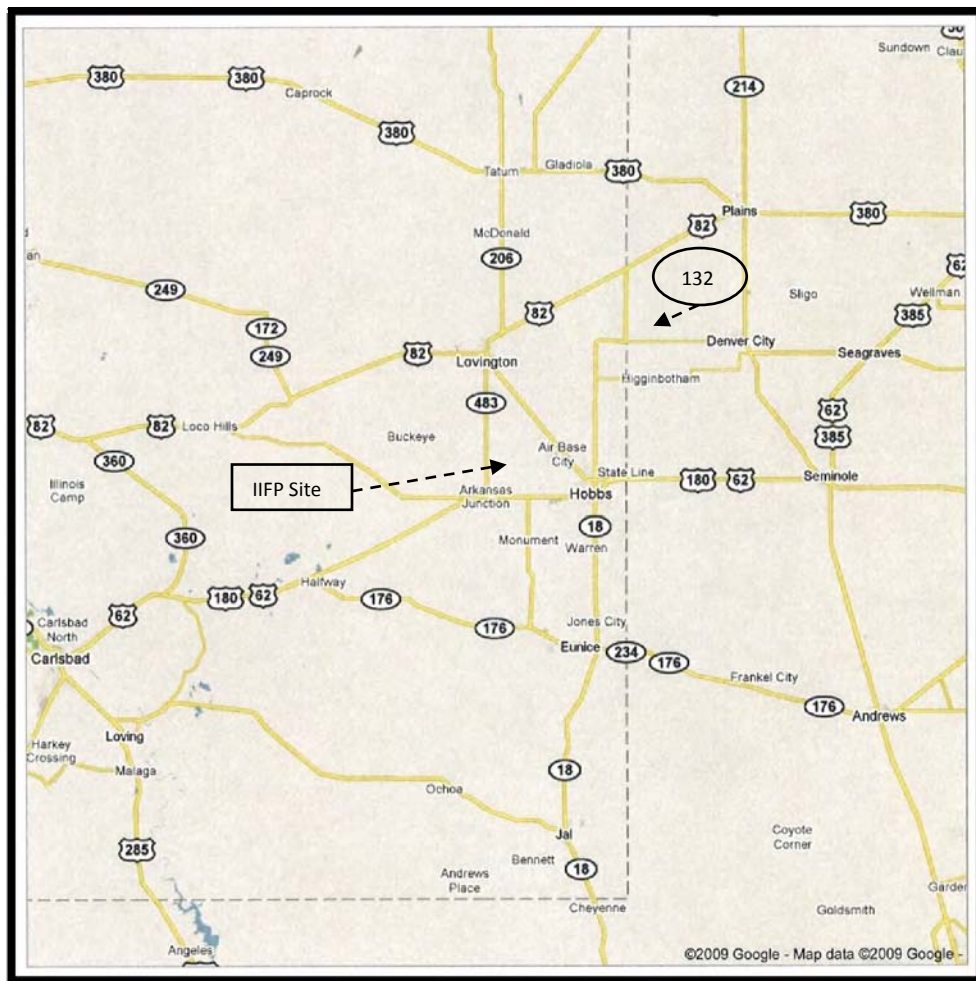

Figure 3- 12 Transportation Infrastructure for Southeastern New Mexico

The nearest U.S. interstate is Interstate 20, approximately 145 km (90 mi) to the southeast in Odessa, Texas. Additional information regarding corridor dimensions, corridor uses, and traffic patterns and volumes is provided in ER Section 4.2, “Transportation Impacts.”

Limited rail services are available in Lea County. There is a short-line run by the Texas-New Mexico Railroad through Hobbs to the east about 22.5 km (14 mi) from the site. Traffic includes liquid propane gas (LPG), liquid asphalt, aggregate, cotton, scrap metal, salt cake, sand, sulfuric acid, and hazardous waste (EDCLC, 2008). Approximately 400 cars per year travel on this rail.

Several airports are in the area. The nearest airport is the Lea County Regional Airport approximately 13 km (8 mi) air space east of the site. The Hobbs Industrial Airpark is approximately 48 km (30 mi) from the site via U.S. 62/180 and NM 234 north toward Humble City, New Mexico which is equivalent to 9 miles air space. The closest international airport to Hobbs is located in the Midland/Odessa, Texas area [134 km (80 mi) from Hobbs]. Additionally, Lubbock International Airport is 158 km (98 mi) from Hobbs.

3.2.2 Transportation Modes and Routes

3.2.2.1 Pre-Licensing Construction and Facility Construction Phases

The mode of transportation for construction materials and construction waste disposal will consist of over-the-road trucks, ranging from heavy-duty 18-wheeled delivery trucks, concrete mixing trucks and dump trucks, to box and flatbed type light-duty delivery trucks. The primary transportation route for conveying construction material from the east and west is U.S. 62/180 via NM 483 to the site. New Mexico Highway 483 will be used for construction materials needed from the north from Lovington. Some materials may come from the south (Eunice) via NM 234 and 8 then U.S. 62/180 and NM 483. An alternate route from the south would be NM 18 to Hobbs then U.S. 62/180 and NM 483 to the site. Construction materials associated with any pre-licensing construction activities would also flow through these corridors. Construction workers would use these same routes.

3.2.2.2 Facility Operation Phase

Radioactive material shipments will be transported in packages that meet the requirements of 40 CFR 71 (CFR, 2009m) and 49 CFR 171-173 (CFR, 2009hh; CFR, 2009ii). Incoming radioactive material shipments will consist of depleted uranium feed in 48-Y or 48-G UF₆ cylinders. Outgoing radioactive material shipments will consist of depleted uranium oxides and associated low-level waste (LLW). The conveyances and associated routes for these radioactive material shipments are discussed below.

Depleted Uranium Feed

The uranium feed for the IIFP plant is primarily in the form of depleted uranium hexafluoride (DUF₆). Some uranium feed may be received in the form of depleted uranium tetrafluoride (DUF₄). Both of the materials are received in the physical solid state. The depleted UF₆ tails are typically stored and shipped in 48-Y or equivalent ANSI N14.1 approved cylinders. These cylinders are designed, fabricated and shipped in accordance with American National Standard Institute N14.1, Uranium Hexafluoride--Packaging for Transport (ANSI, 2001). See Table 3-1 for a summary of the characteristics of cylinders that would be shipped under the Proposed Action. If any DUF₄ is received, it will be contained in approved shipping containers in accordance with DOT regulations.

Table 3- 1 Characteristics of Uranium Cylinders

Parameter	48X Cylinder¹	48Y Cylinder	48G Cylinder²
Material	Steel	Steel	Steel
Nominal Length (inches)	119	150	146
Nominal Diameter (inches)	48	48	48
Wall Thickness (inches)	0.625	0.625	0.3125
Volume (ft ³)	108.9	142.7	139.0
Weight Limit (MT UF ₆)	9.539	12.501	12.174
Weight Limit (MTU)	6.45	8.45	8.235
Maximum Enrichment (wt % ²³⁵ U)	4.5	4.5	1.0

¹Typically used for enriched uranium of less than 4.5% U-235.

²48G cylinders are not in use at the NEF but are in use at the Paducah, KY and Portsmouth, OH sites.

Source: (ANSI, 2001)

The cylinders containing DUF₆ are transported to the site by 18-wheeled trucks, one cylinder per truck via U.S. 62/180 and NM 483. U.S. Highway 62/180 is of four-lane construction and is a well established radioactive waste transportation corridor established by the Department of Energy (DOE) for shipping transuranic and mixed wastes. Initially the DUF₆ feed material is expected to come from the National Enrichment Facility (NEF) near Eunice, New Mexico. Other potential sources of DUF₆ would be from Global Laser Enrichment (GLE) facility proposed to be built in Wilmington, NC, the AREVA NP facility proposed to be built near Idaho Falls, Idaho. Both have applied for an NRC license to enrich UF₆.

Another potential DUF₆ supplier/customer could be the U.S. Enrichment Corporation (USEC) facility in Paducah, KY. This DUF₆ is presently stored in 48-G cylinders. The 48-G cylinders may require the supplier to obtain a DOT exemption for over-the-road shipment. The type 48-G cylinders have been shipped in the past by the DOE, but typically it has been used in the industry as an on-site storage cylinder for DUF₆. If a customer were to contract for shipment of DUF₆ to the IIFP facility using type 48-G cylinders, the arrangement would require emptying the cylinder into the IIFP process and providing for final disposition of the empty cylinder. One means of disposing of the empty cylinder is to use it as a waste container for uranium oxide that is sent to the licensed disposal facility.

A potential source of DUF₄ would be from DOE inventory located at their facility near Piketon, Ohio.

Uranium Wastes

Radioactive waste materials will be transported in packages by truck via highway in accordance with 40 CFR 71 (CFR, 2009m) and 49 CFR 171-173 (CFR, 2009hh; CFR, 2009ii). Detailed descriptions of radioactive waste materials which will be shipped from the IIFP facility for disposal are presented in ER Section 3.12, "Waste Management." These wastes will typically be packaged and shipped in 55-gal drums using trucks with a nominal 20 to 25 drums per truck shipment.

Low-Level Radioactive Waste generated from the processing the DUF₆ will be shipped to an off-site disposal facility. The expected disposal site is the Energy Solutions facility at Clive, UT. A potential site that could be licensed in the future is the Waste Control Specialists facility near Eunice, NM. Refer to ER Section 3.12.2.2, "Radioactive and Mixed Wastes," for disposition options of other wastes.

Transportation Routes

Transportation routes for both incoming DUF₆ feed and outgoing uranium wastes will be those routes designated by the U.S. Department of Transportation to minimize the potential impacts to the public from the transportation of radioactive materials. Detailed discussions of specific transportation routes are discussed in Chapter 4.

The highways in the vicinity of the site serve as trucking routes for the local area. Traffic volume on these highways varies greatly during the day. The condition and design basis for these roadways are adequate to meet current traffic flow requirements and future minor changes to traffic patterns brought about by the construction phases and operation of the IIFP facility.

3.2.3 Land Use Transportation Restrictions

Highway easements associated with state trust land is for highway use only, although application for other uses (i.e., installation of utilities) may be submitted to the state. There are no known restrictions on the types of materials that may be transported along the important transportation corridors.

3.3 Geology and Soils

This section provides a brief description of the regional and local geology and identifies the characteristics of the soil and mineral resources at the proposed IIFP site in Lea County, New Mexico. Lea County is located in the Pecos Valley Section of the Great Plains Province, very near the boundary between the Pecos Valley Section to the west; and the Southern High Plains Section to the east and north. The boundary between the two sections is the Mescalero Escarpment, locally referred to as Mescalero Ridge. Refer to Figure 3-13, "Regional Physiography" The ridge is a nearly vertical cliff with a relief of approximately 46 m (150 ft) in northwestern Lea County. In southeastern Lea County, the Ridge is partially covered by wind deposited sand and therefore is less prominent, typically exhibiting 9 to 15 m (30 to 50 ft) of relief. The Mescalero Ridge is also shown in Figure 3-14, "Llano Estacado and Vicinity." Locally, the Southern High Plains Section is referred to as the Llano Estacado. The Llano Estacado is a high, isolated pediment surface mesa that covers much of the Texas Panhandle and eastern third of southeastern New Mexico. The Llano Estacado plateau occupies approximately 37,000 mi² (22 million acres). The region is devoid of native trees except for the shinoak and mesquite. The Llano slopes gently to the southeast by 2.4 to 3.1 m (8 to 10 ft) per mile. With no geological relief, the only changes in elevation are the approximately 34,000 shallow depressions called playas. The Llano Estacado is the largest, isolated non-mountainous geological area in North America, which is why endemic plants and animals are found there (Sibley Nature Center, 2009). South of the Portales Valley, the caliche caprock of the Ogallala Formation is generally near the surface; elsewhere, it is buried by sandy and clayey deposits (UMN, 2006). Surface drainage on the Southern High Plains (Llano Estacado) is poor, with larger regional drainages along northwest to southeast lineaments.

The Llano Estacado surface is underlain by the Ogallala Formation, which is composed of fluvial gravels exposed at the base with thicker eolian fine sand above. It is capped by the caprock, a 3-m (9-ft) thick calcrete that is the resistant layer upon which the Llano Estacado is formed (UNM, 2006). The surface geology is dominated by erosion that has exposed the upper weathered surface of the Caprock. Bioturbation of site sediments by rodents and insects may be severe. In some places, young deposits are present that include slope-wash sediments along the margins of playas and eolian sand deposits on the leeward (east) side of playas. Thin eolian deposits also occur along the northern edge of the southern lobe of the Llano, the sand derived from the Mescalero Plain. The IIFP site is located west of the Llano

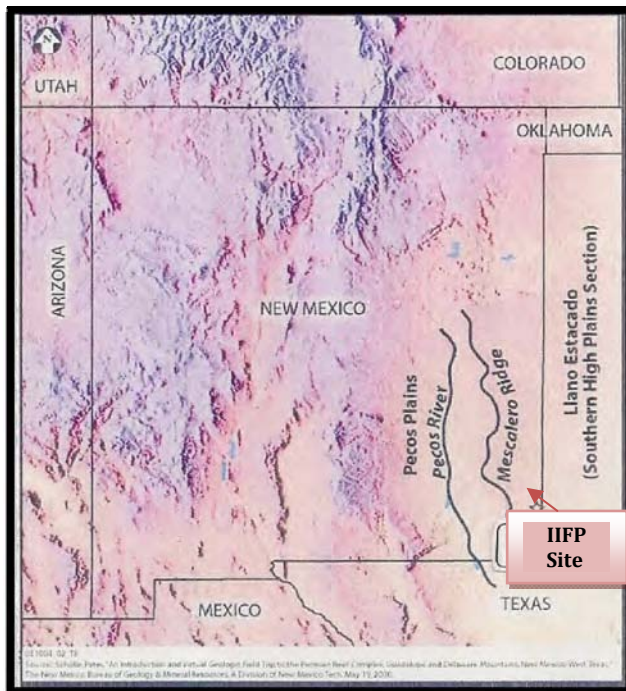

Source: NRC, 2005

Figure 3- 13 Regional Physiography

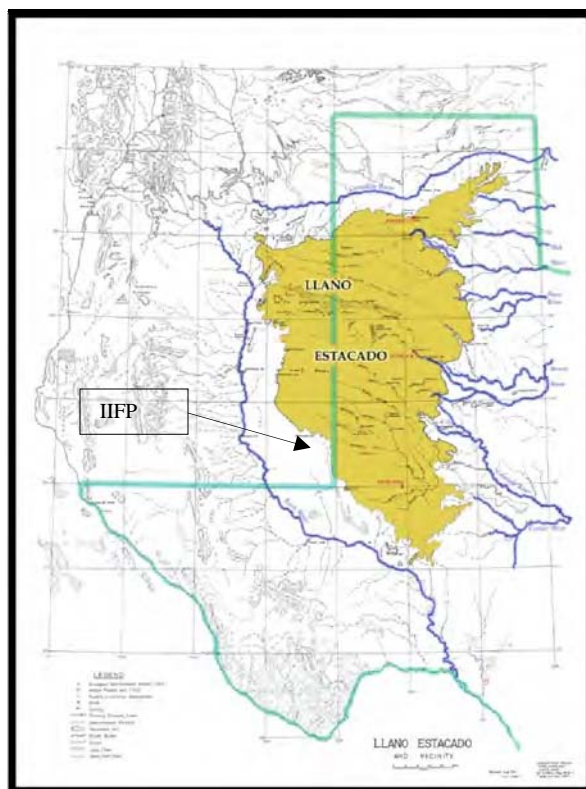

Source: Sibley Nature Center, 2009

Figure 3- 14 Llano Estacado and Vicinity

Estacado caprock and east of the Mescalero Plain in southeastern New Mexico. Refer to Figure 3-15, “Physiography of Southeast New Mexico.” The draws across some areas of the Llano are old drainages filled with Holocene-age sediment (UNM, 2006).

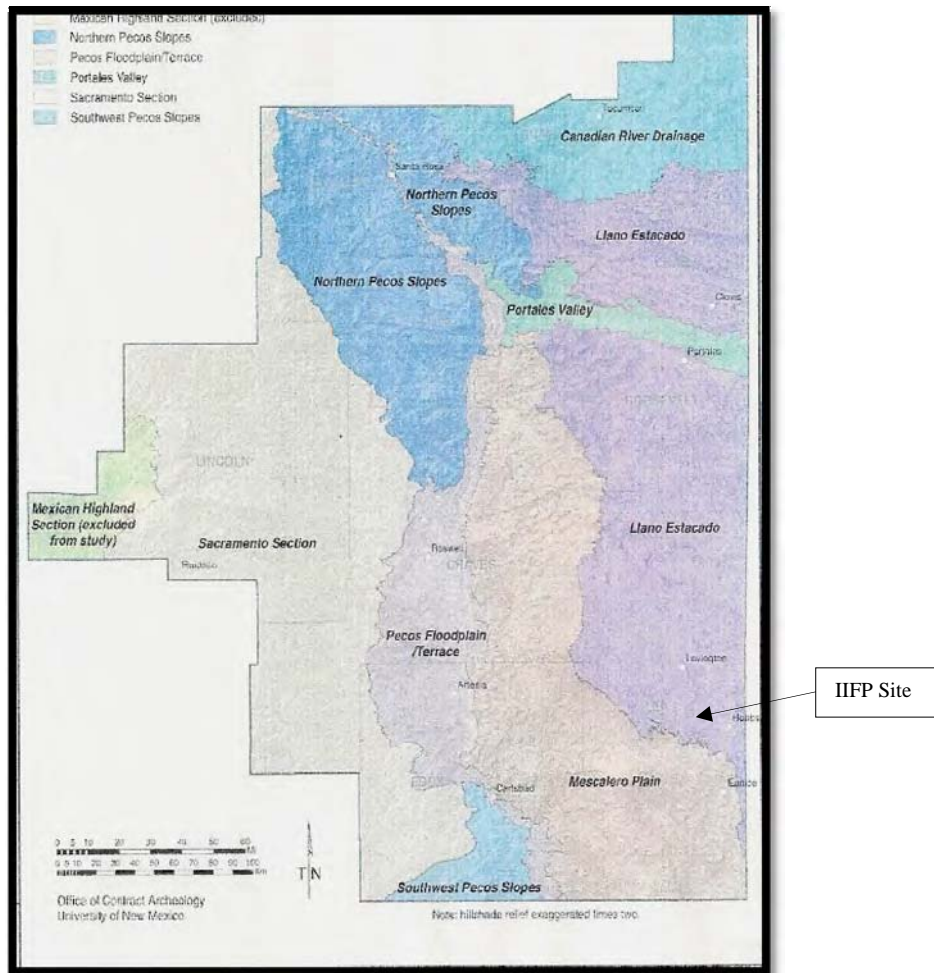

Source: UNM, 2006

Figure 3- 15 Physiography of Southeast New Mexico

In southern Lea County, Mescalero Ridge is an irregular erosional topographic feature with a relief of about 9.1 to 15.2 m (30 to 50 ft) compared with a nearly vertical cliff and relief of approximately 45.7 m (150 ft) in Northwestern Lea County. The lower relief of the ridge in the southeastern part of the county is due to partial cover by wind-deposited sand. See Figure 3-16 to see where the ridge cuts through Lea County at the proposed site of the IIFP facility.

The dominant geologic feature of this region is the Permian Basin. The Permian Basin is a massive subsurface bedrock structure that has a downward flexure of a large thickness of originally flat-lying, bedded, sedimentary rock. The Permian Basin extends to 4,880 m (16,000 ft) below mean sea level. Figure 3-17 and Figure 3-18 show the major physiographic features of the Permian Basin. Figure 3-17 contains a cross-reference line to Figure 3-18 showing the features of the Permian Basin below the present day sea level. The proposed IIFP site is located within the Central Basin Platform area. The Central Basin Platform divides the Permian Basin into the Midland and Delaware sub-basins. The top of

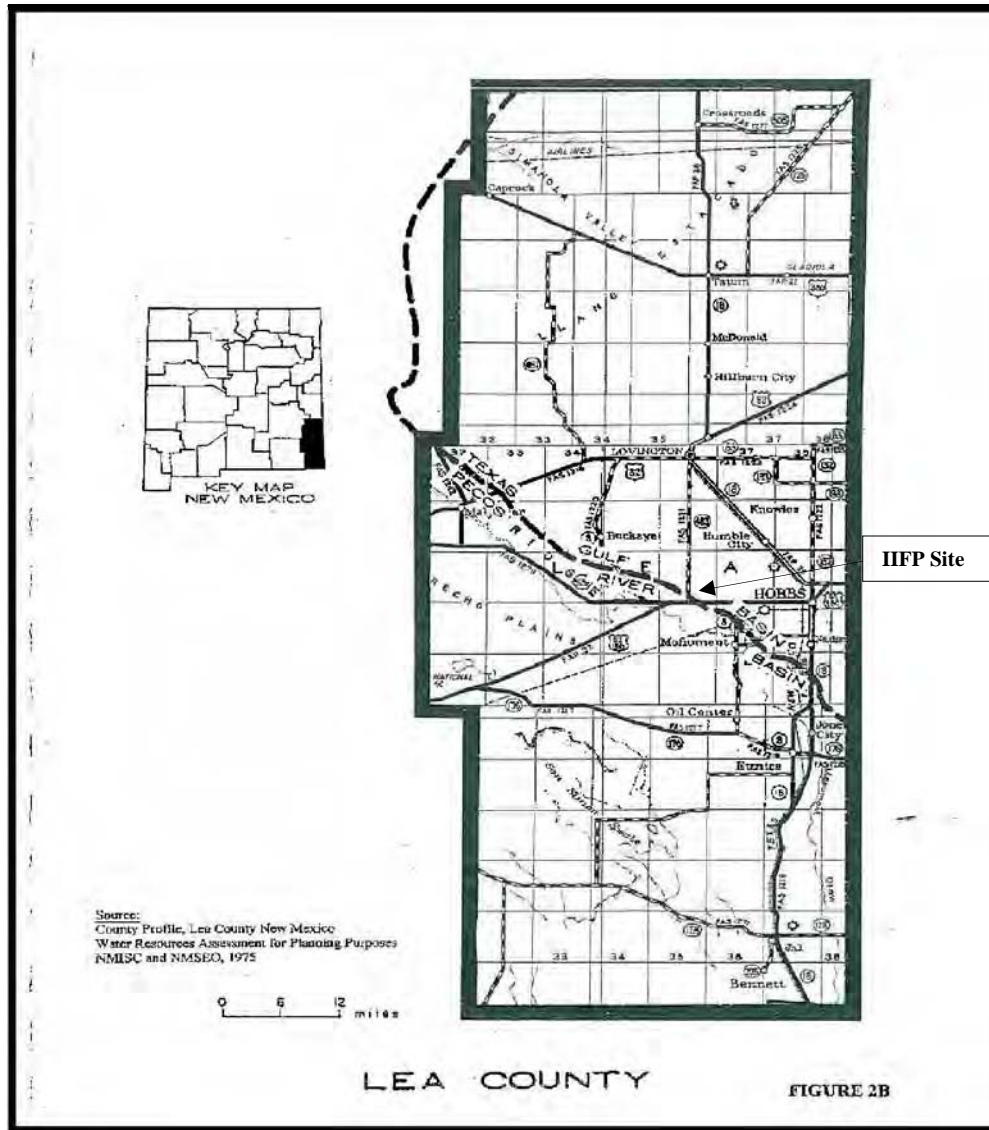

Source: LCWUA, 2000

Figure 3- 16 The Mescalero Ridge As It Crosses Lea County at Proposed IIFP Site

the Permian deposits are approximately 434 m (1,425 ft) below ground surface at the proposed IIFP site. Overlying the Permian are the sedimentary rocks of the Triassic Age Dockum Group.

The upper formation of the Dockum Group is the Chinle Formation, a tight claystone and silty clay layer. The Chinle Formation is regionally extensive with outcrops as far away as the Grand Canyon region in Arizona. In the vicinity of the site, the Chinle Formation consists of red, purple, and greenish micaceous claystone and siltstone with interbedded fine-grained sandstone. The Chinle (also known as Red Bed) Formation is overlain by Tertiary Ogallala, Gatuna, or Antlers Formations (alluvial deposits). Caliche is a partly indurated zone of calcium carbonate deposits accumulation formed in the upper layer of surficial deposits. Soft caliche is interbedded with the alluvial deposits near the surface.

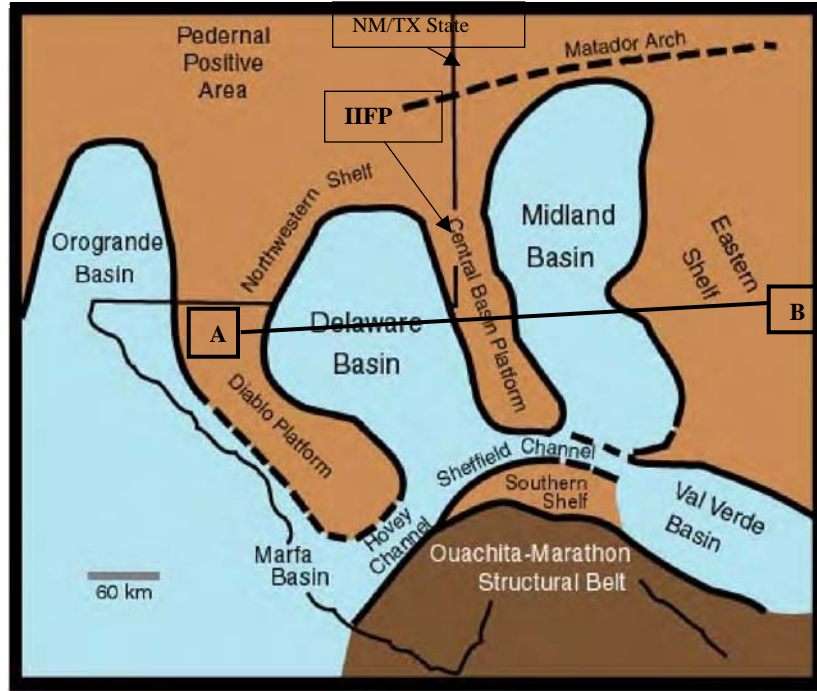

Source: Scholle, 2000

Figure 3- 17 Major Physiographic Features of the Permian Basin Region (With Cross-Section Line to Figure 3-18)

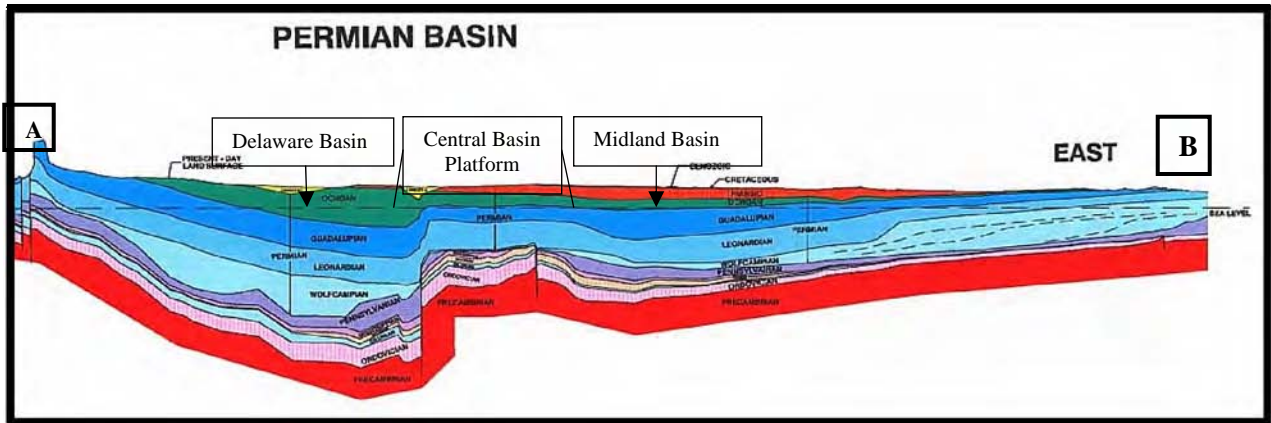

Source: Scholle, 2000

Figure 3- 18 Major Physiographic Features of the Permian Basin Region (Below Sea Level View)

3.3.1 Seismology

The Hobbs site is in a seismically quiet region, with nearby earthquakes being of small magnitude and generally caused by oil field injection activities. There are no Holocene faults in the area and no threat of liquefaction or other earthquake-related hazards exist at the site. The site has no unstable Karst (sinkhole) areas.

The majority of earthquakes in the United States are located in the tectonically active western portion of the country. However, areas within New Mexico and the southwestern United States also experience earthquakes, although at a lower rate and at lower intensities. Earthquakes in the region around the IIFP site include isolated and small clusters of low to moderate size events toward the Rio Grande Valley of New Mexico and in Texas, southeast of the IIFP site.

Table 3-2 summarizes IIFP site peak horizontal ground acceleration (pga) for various recurrence intervals of potential interest (1,000, and 2,500 years). As noted below, T is the earthquake return period, P is the annual probability of exceedance, EP is the probability of exceedance in n years when n is taken to be 50 years. The pga values of 0.03g and 0.12g for 500 and 2,500 year recurrence interval earthquakes, respectively, are determined from the United States Geological Survey (USGS) seismic hazard tables for the site latitude and longitude (USGS 2002). The pga of 0.03 for the 500 year recurrence interval earthquake was determined by Weber (Weber, 2008). The NEF in nearby Eunice, NM based its design on a pga of 0.12g which is quite consistent with the 2,500 year earthquake at the IIFP site. Probabilistic ground motion for the sites is also shown in Table 3-2. Seismic activity is well documented as the result of the NEF license application and the extensive network of seismometers established for the Waste Isolation Pilot Plant (WIPP) facility. The Peak Horizontal Ground Acceleration for a 1,000 and 2,500 year return is 0.05g and 0.12g respectively (USGS, 2002).

Table 3- 2 Seismic Criteria for New Mexico Site

P=1/T	EP=1-(1-P)ⁿ		n=50 years
T	500 yrs	1000 yrs	2500 yrs
P	0.002 (.2%)	0.001 (.1%)	0.0004 (.04%)
EP	0.1 (10%)	0.05 (5%)	0.02 (2%)
n	50 yrs	50 yrs	50 yrs
pga	0.03g⁽¹⁾	0.05g⁽²⁾	0.12⁽²⁾

⁽¹⁾ Weber, 2008

⁽²⁾ USGS, 2002

3.3.1.1 Seismic History of the Region and Vicinity

The IIFP site is located within the Permian Basin. Specifically, the site is located near the northern end of the Central Basin Platform (CBP). See Figure 3-17 showing the location of the proposed site in the CBP. The CBP became a distinct dividing feature within the Permian Basin as a result of Pennsylvanian and early Permian compressional stresses. This tectonism resulted in a deeper Delaware Basin to the west and shallower, Midland Basin to the east of the ridge-like CBP.

The last episode of tectonic activity centered on the late Cretaceous and early Tertiary Laramide Orogeny that formed the Cordilleran Range to the west of the Permian Basin. The Permian Basin region was uplifted to its present position during this orogenic event. There has not been any further tectonic activity since the early Tertiary. Structurally, the Permian Basin has subsided slightly since the Laramide tectonic event. Dissolution of Permian evaporate layers by groundwater infiltration or possibly from oil and gas extraction is suggested as a possible cause for this observed subsidence.

The 250-million year old Permian Basin is the source of abundant gas and oil reserves that continue to be extracted. These oil fields in southeast New Mexico are characterized as "in a mature stage of secondary recovery effort" (Talley, 1997). Water flooding began in the late 1970's followed by carbon dioxide (CO₂)

flooding now being used to enhance recovery in some fields. Industry case studies describe hydraulic fracturing procedures used in the Queen and San Andres formations near the IIFP site that produced fracture half-lengths from 170 to 259 m (560 to 850 ft) in these formations.

Seismic activity in southeastern New Mexico is typically of small magnitude and generally caused by oil field injection activities. However, one of the most recent major earthquakes (moment magnitude of > 4.5 on the Modified Mercalli-Revised 1931 scale) in New Mexico occurred south of Eunice in January 1992. The earthquake was 5.0 on the Modified Mercalli (Md) scale with its epicenter at 32.3 degrees North and 103.2 degrees West (Yarger, 2009). See Figure 3-19, “Detailed Map Showing Lea County Earthquakes from 1962 to 1998.”

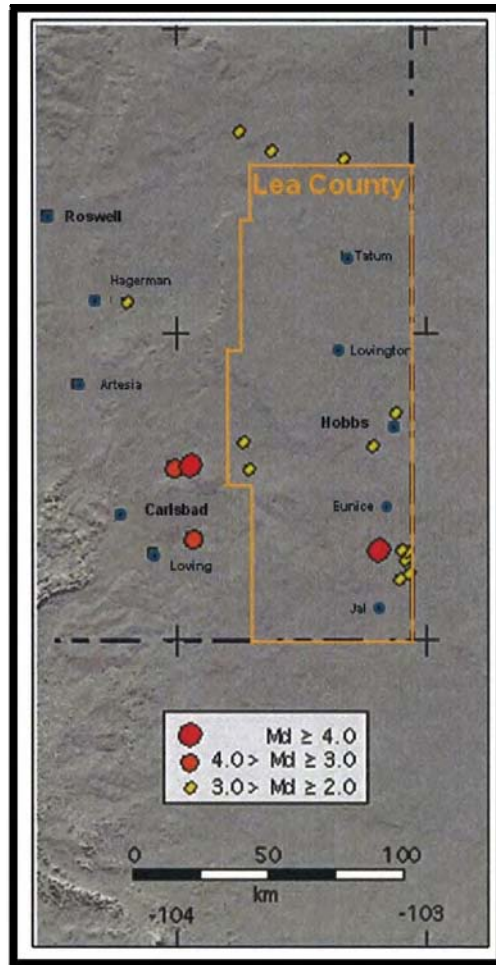

Source: Yarger, 2009

Figure 3- 19 Detailed Map Showing Lea County Earthquakes from 1962 to 1998

Table 3-3 lists the strongest earthquakes that have occurred in New Mexico between 1860 and 1998, including the Eunice earthquake. Only one major earthquake has occurred in New Mexico since 1998, a moment magnitude 4.9 earthquake located approximately 60 km northwest of the city of Raton, along the Colorado-New Mexico border, on August 10, 2005. The majority of significant earthquakes have occurred along the Rio Grande Rift Zone, particularly in the vicinity of Socorro where a large

Table 3- 3 Strongest Earthquakes in New Mexico – 1980 through May 1998

Date	Approx. Location		Maximum Intensity Modified Mercalli)	Estimated Md	Nearby City
	Latitude (N)	Longitude (W)			
1869	34.1	106.9	VII	5.2	Socorro
9/07/1893	34.7	106.6	VII	5.2	Belen
10/31/1895	34.1	106.9	VI	4.5	Socorro
1897	34.1	106.9	VI	4.5	Socorro
9/10/1904	34.1	106.9	VI	4.5	Socorro
7/02/1906	34.1	106.9	VI	4.5	Socorro
7/12/1906	34.1	106.9	VII to VIII	5.5	Socorro
7/16/1906	34.1	106.9	VII	5.8	Socorro
11/15/1906	34.1	106.9	VIII	5.8	Socorro
12/19/1906	34.1	106.9	VI	4.5	Socorro
5/28/1918	35.5	106.1	VII to VIII	5.5	Cerrillos
2/05/1931	35.0	106.5	VI	4.5	Albuquerque
2/21/1935	34.5	106.8	VI	4.5	Bernardo
12/22/1935	34.7	106.8	VI	4.5	Belen
9/17/1938	33.3	106.5	VI	4.5	Glenwood
9/20/1938	33.3	106.5	VI	4.5	Glenwood
9/29/1938	33.3	106.5	VI	4.5	Glenwood
11/02/1938	33.3	106.5	VI	4.5	Glenwood
1/20/1939	33.3	106.5	VI	4.5	Glenwood
6/04/1939	33.3	106.5	VI	4.5	Glenwood
11/06/1947	35.0	106.5	VI	4.5	Albuquerque
5/23/1949	34.6	106.4	VI	4.5	Vaughn
8/03/1955	37.0	107.3	VI	4.5	Dulce
7/23/1960	34.4	106.9	VI	4.5	Bernardo
7/03/1961	34.2	106.9	VI	4.5	Socorro
1/23/1966	37.0	107.0		4.8	Dulce
1/05/1976	35.9	106.5		4.7	Gallup
11/29/1989	34.5	106.9		4.7	Bernardo
1/29/1990	34.5	106.9		4.6	Bernardo
1/02/1992	32.3	106.2		5.0	Eunice

Source: Yarger, 2009

underground magma pocket exists, known as the Socorro Seismic Anomaly (Yarger, 2009). See Figure 3-20, “Seismicity of New Mexico and Bordering Areas.”

The Hobbs site is in a seismically quiet region, with nearby earthquakes being of relatively small (< 2.0 Md) magnitude. No Quaternary faults or folds, thought to be associated with most earthquakes of moment magnitude 6 or greater over the last 1.6 million years, exist in the southeast New Mexico/west Texas region (Yarger, 2009). Seismic activity in the region appears to be primarily associated with the Central Basin Platform of the Wolfcamp Formation which underlies the Permian Basin. The Central Basin Platform is a long, north-south oriented ridge that sits between the Delaware Basin and the Midland Basin to the east (refer to Figure 3-17 and Figure 3-18).

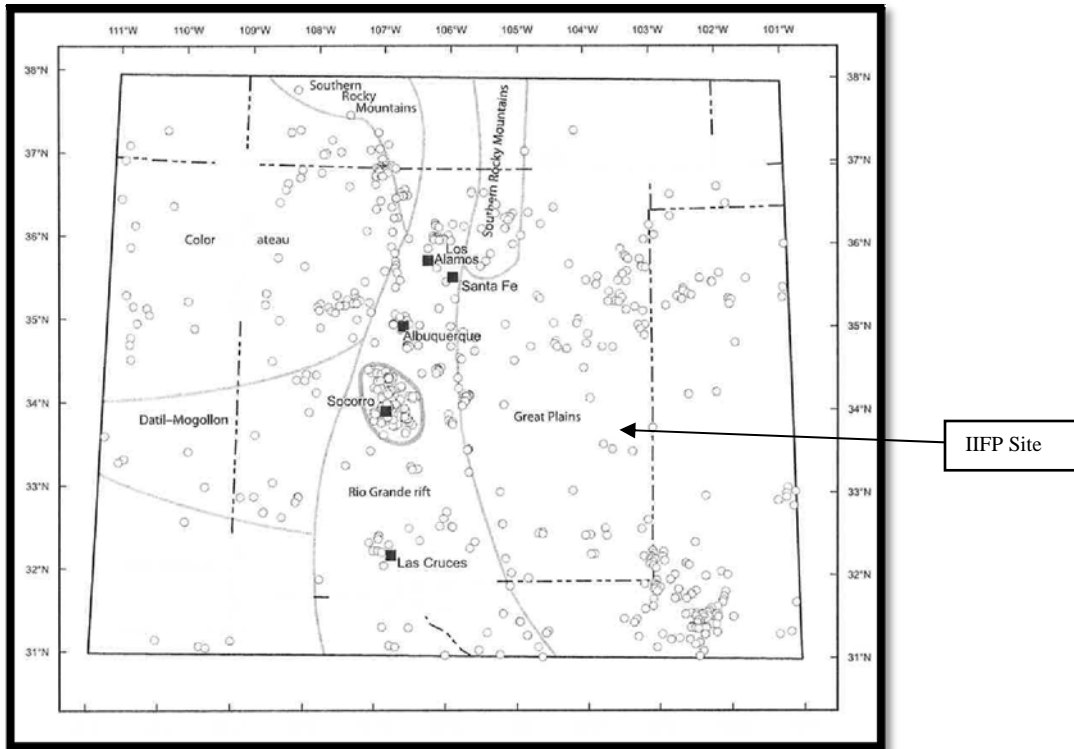

Source: NMIMT, 2002

Figure 3- 20 Seismicity of New Mexico and Bordering Areas

The New Mexico Institute of Mining and Technology has generated probabilistic seismic hazard estimates for different magnitude of earthquakes. Figure 3-21 and Figure 3-22 show horizontal peak ground acceleration (g) for an earthquake M_d of 6 in New Mexico (10% probability of exceedance in a 50-year period). For a horizontal ground acceleration of 0.2 g, the risk of structural damage is minimal for a modern well-designed building, but non-structural risk damage can be significant (Yarger, 2009).

The nearest recent faulting is situated more than 161 km (100 mi) west of the site (Machette, 1998). The study of historical seismicity includes earthquakes in the region of interest known from felt or damage records and from more recent instrumental records (since early 1960's). Most earthquakes in the region have left no observable surface fault rupture. See Figure 3-20 which shows the seismicity of New Mexico and bordering areas, from latitude 31° to 38° and longitude 101° to 111° , during the time period 1996 to 1998 with moment magnitudes of 3.0 or greater (NMIMT, 2002).

Earthquake parameters (e.g., date, time, location coordinates, magnitudes, etc.) from the data repositories were combined into a uniformly formatted database to allow statistical analyses and map display of the four catalogs. Through a process of comparison of earthquake entries among these four catalogs, duplicate events were purged to achieve a composite catalog. In addition, aftershocks and aftershock sequences were purged from one version of the catalog for computation of earthquake recurrence statistical models, which describe recurrence rates of earthquake main shocks. The large majority of events (i.e., 82%) in the composite catalog originate from the Earthquake Catalogs for New Mexico (exclusive of the Socorro New Mexico immediate area) (NMIMT, 2002). Earthquake magnitudes in these catalogs are tied to the New Mexico duration magnitude scale, M_d , which in turn approximates Local Magnitude, M_L . All events in the composite catalog are specified to have an undifferentiated local magnitude.

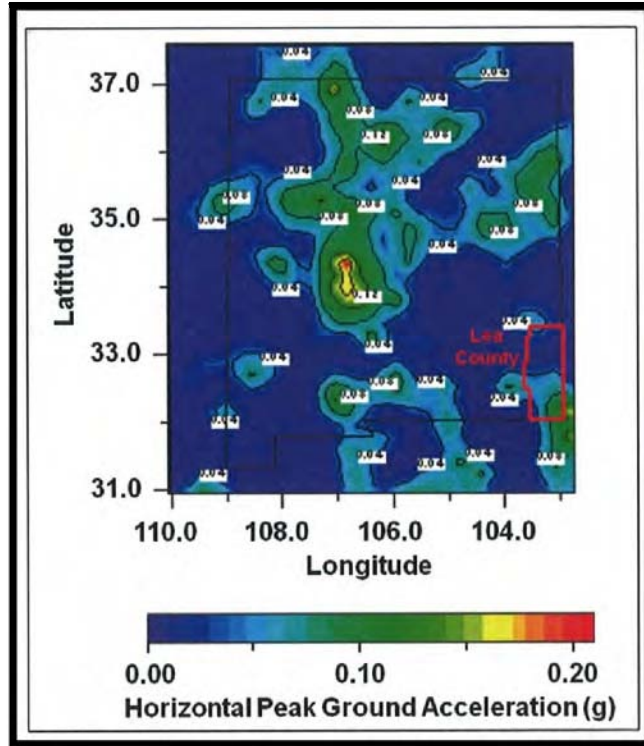

Source: Yarger 2009. Adapted from Lin et.al. 1998

Figure 3- 21 New Mexico Seismic Hazard for a Moment Magnitude (Md) 6 Earthquake

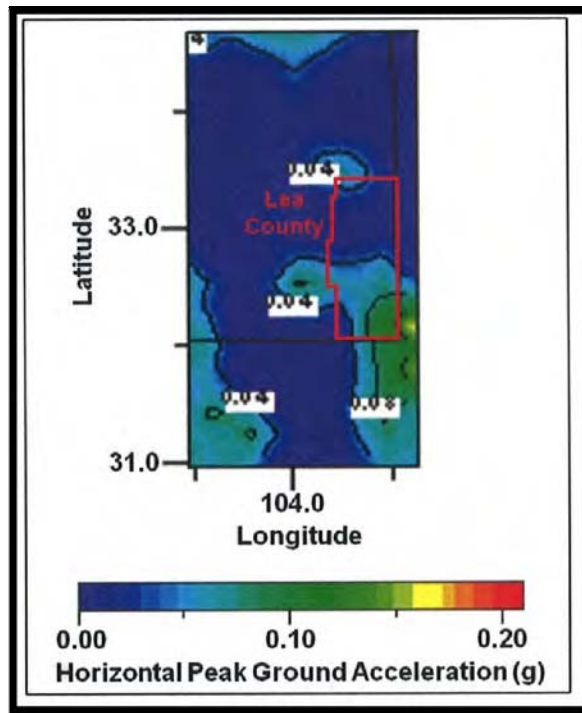

Source: Yarger, 2009. Adapted from Lin et.al, 1998

Figure 3- 22 Detailed Map Showing Lea County Seismic Hazard for a Moment Magnitude (Md) 6 Earthquake

3.3.1.2 Correlation of Seismicity with Tectonic Features

Most epicenters lie within the Central Basin Platform; however, earthquake clusters also occur within the Delaware and Midland Basins. Refer to Figure 3-17 and Figure 3-18, which depict major physiographic features of the Permian Basin. Although events local to the IIFP site are likely induced by gas/oil recovery methods, the resulting ground motions are transmitted similar to earthquakes on tectonic faults. Furthermore, given the published uncertainties on discrimination between natural and induced seismic events and those earthquake focal depths, critical for correlation with oil/gas reservoirs, are largely unavailable. The January 2, 1992 event is attributed to a tectonic origin. For this magnitude 5 earthquake, focal depths range from 5.0 km (3.1 mi) (USGS, 2004a) to 12.2 km (7.5 mi) (DOE, 2003d). Therefore, **studies** conclude that seismological data are insufficient for this moderate earthquake to constrain the depth sufficiently to permit a correlation with local oil/gas producing horizons.

The Waste Isolation Pilot Project (WIPP) Safety Analysis Report (SAR) (DOE, 2003d) suggests that the cluster of small events located along the Central Basin Platform are not tectonic in origin, but are instead related to water injection and withdrawal for secondary recovery operations in oil fields in the Central Basin Platform area. (See Figure 3-17 and Figure 3-18.) Such a mechanism for the Central Basin Platform seismic activity could provide a reason why the Central Basin Platform is separable from the rest of the Permian Basin on the basis of seismicity data, but not by using other common indicators of tectonic character. Both the spatial and temporal associations of Central Basin Platform seismicity with secondary recovery projects at oil fields in the area are suggestive of some cause and effect relationship of this type. Published studies (DOE, 1980) and ongoing research strongly suggest that a large fraction of activity in southeastern New Mexico and adjacent areas of west Texas is induced by production, secondary recovery, or waste injection within this petroleum and natural gas province.

3.3.2 Site Soils

Two areas having different soil associations exist in Lea County. They are also divided by the Mescalero Ridge and include the southern High Plains and the southern Desertic Basins, Plains, and Mountains. See Figure 3-23, "General Soil Map, Lea County, New Mexico." The southern High Plains areas, in the northern half of Lea County in which the IIFP site is located, consists of five related soil associations, Kimbrough, Kimbrough-Lea, Portales-Stegall-Lea, Amarillo-Arvana, and Brownfield-Patricia-Tivoli. The associations are generally comprised of shallow to deep gravelly and loamy soils or deep sandy soils formed from windblown and water-deposited materials in the Quaternary and late Tertiary periods (LCWUA, 1998). Soft or hard caliche is generally found to below soils in the majority of this area. Caliche refers to a buff, white, or reddish brown calcareous material commonly found in layers on or near the surface of soils in arid regions.

Table 3-4 provides a summary of the characteristics of the primary soils in the Southern High Plains area in Lea County in which the proposed site is located. The table provides a description of the soil series, the total depth, the permeability, salinity, degree of limitation for the filter field, and the shrink/swell potential. The shrink/swell potential is of great importance in the construction industry in that it is the relative change in volume to be expected with changes in moisture content, that is, the extent to which the soil shrinks as it dries out or swells when it gets wet. Extent of shrinking and swelling is influenced by the amount and kind of clay in the soil. Shrinking and swelling of soils causes potential damage to building foundations, roads and other structures. A high shrink/swell potential indicates a hazard to maintenance of structures built in, on, or with material having this rating. The IIFP site has predominantly Kimbrough and Lea soils which have moderate and low ratings which lessen the hazard accordingly.

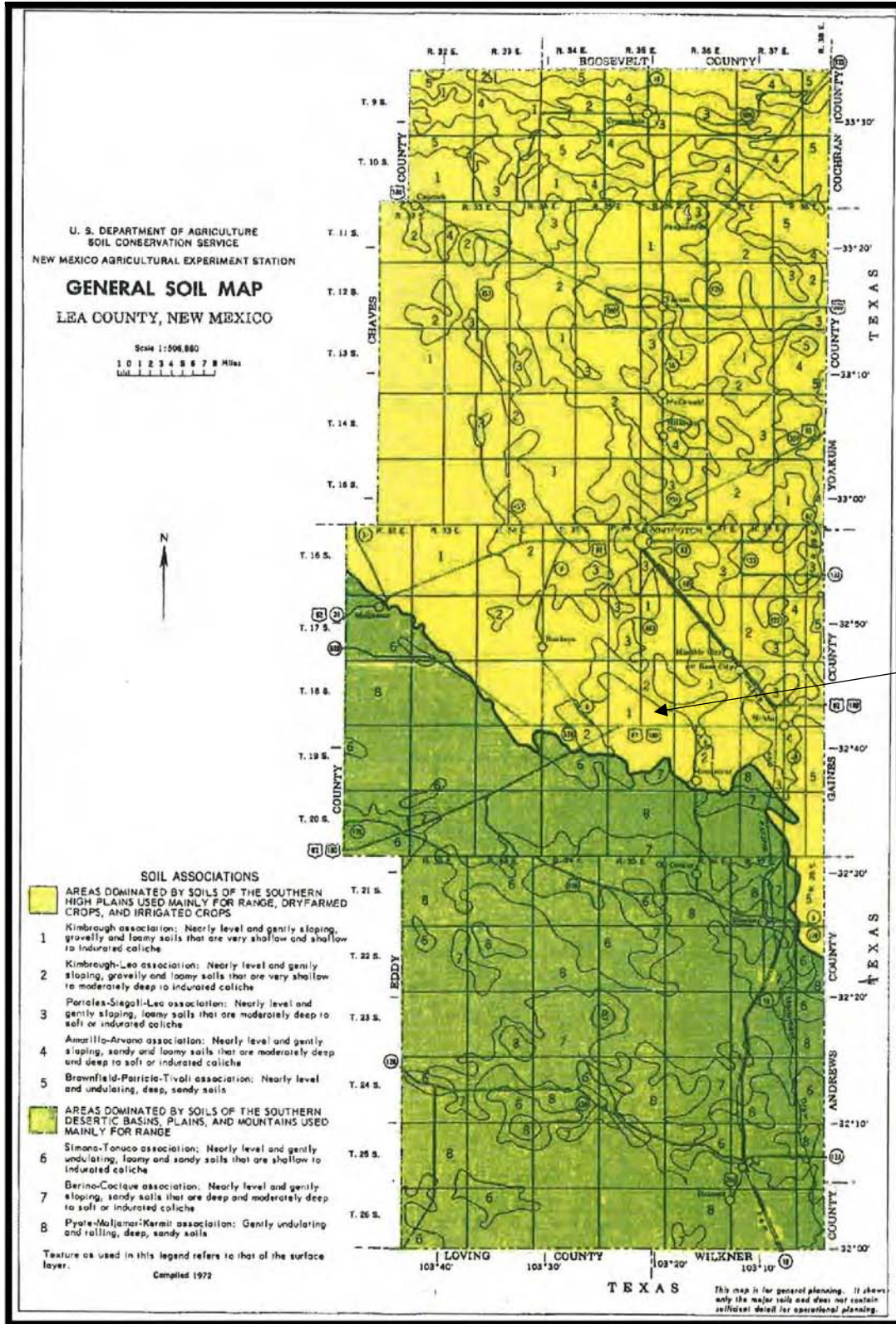

Source: LCWUA, 1998

Figure 3- 23 General Soil Map, Lea County, New Mexico

Table 3- 4 Summary of Characteristics of the Primary Soils in Southern High Plains Area in Lea County, New Mexico

Soil Series	Description	Total Depth (In.)	Permeability (In/hour)	Salinity (Mmhos/cm)	Degree of Limitation for Filter Field	Shrink-Swell Potential
Amarillo	Sandy clay loam, chalky loam	60	0.63 to 2.0	0 to 1	Slight to moderate: moderate permeability	Low to moderate
Arvana	Sandy clay loam	28	0.63 to 2.0	0 to-1	Severe: indurated caliche at shallow depth	Moderate
Brownfield	Fine sand, sandy clay loam	63	0.63 to 6.3	0 to1		Low to moderate
Kimbrough	Gravelly loam	6	0.63 to 2	0 to 2	Severe: indurated caliche at shallow depth	Low
Lea	Loam	26	0.63 to 2.0	0 to 2	Severe: indurated caliche at shallow depth	Moderate
Patricia	Fine sand, sandy clay loam	70	0.63 to 20.0	0 to 1	Slight to moderate: moderate permeability	Low to Moderate
Portales	Loam and clay loam	60	0.63 to 2.0	0 to 2	Slight to moderate: moderate permeability	Moderate
Stegall	Clay loam	28	0.06 to 0.2	0 to 4	Severe: indurated caliche at shallow depth; slow permeability	High
Tivoli	Fine sand	60	0.63 to 20.0	0 to 1	Slight to moderate: possible contamination of underground water, 0 to 12% slopes	Low

Source: USDA, Soil Conservation Service, 1974
Mmhos/cm – millimhos per centimeter

Soils for the Hobbs site are sandy and well drained, with a well-developed caliche layer occurring at the surface or as shallow as 25.4 to 30.5 cm (10 to 12 in) below the surface in some areas of the site. The soil types and the percentage of each soil in the area of interest are shown in Figure 3-24, “Custom Soil Resource Report Soil Map of the IIFP Site.”

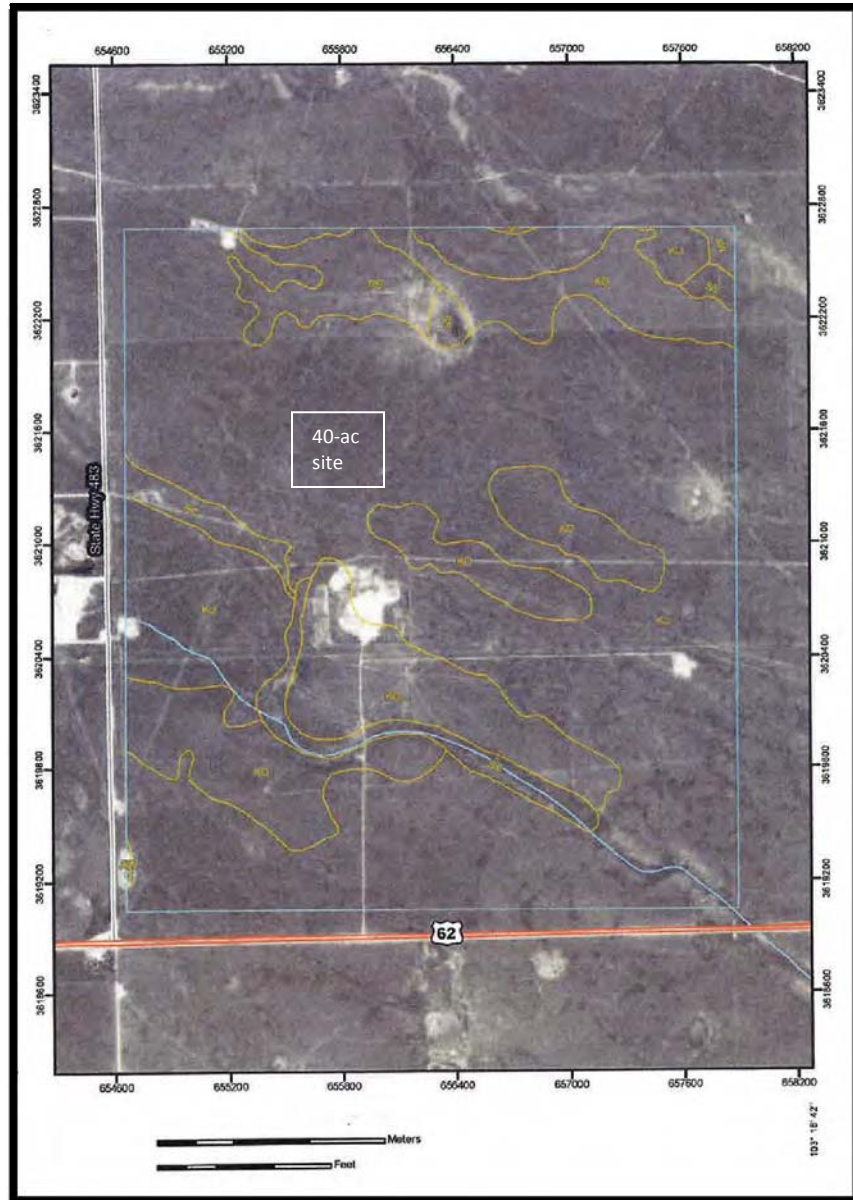

Source: USDA, 2009

Figure 3- 24 Custom Soil Resource Report Soil Map of the IIFP Site

The soil types and the percentage of each soil in the area of interest are listed in Table 3-5. Calcrete, duricrust, and hardpan are other terms used to describe caliche in various forms. No soil sample borings are available for this site; however, the deposit of caliche cap across the site is expected to occur in a thickness range of 2.4 to 7.6 m (8 to 25 ft). Caliche is a local construction material due to its compaction properties. Caliche is frequently used for the construction of well pads, surfacing roads, and as a

Table 3- 5 Characterization of Soils in Proposed Site

Map Unit Symbol	Map Unit Name	Within Proposed Site
AW	Arvana-Lea Association	0.3%
KO	Kimbrough Gravelly Loam, 0% to 3% Slopes	20.9%
KU	Kimbrough-Lea Complex	71.2%
PC	Portales Loam, 0% to 3% Slopes	1.3%
PS	Portales-Stegall Loams	3.2%
SS	Stegall and Slaughter Soils	3.0%
Totals for Area of Interest		100%

Source: USDA, 2009

compacted base-course for buildings and paved roads. The Hobbs site has a caliche rock layer that will have to be negotiated for civil construction work. The site is nearly flat with a slight slope that accommodates drainage.

3.4 Water Resources

This section describes the IIFP site's surface water and groundwater resources. Data are provided for the IIFP site and its general area, and the regional associations of those natural water systems are described. This information provides the basis for evaluation of any potential facility impacts on surface water, groundwaters, aquifers, water use, and water quality. Subsections address surface hydrology, water quality, preexisting environmental conditions, water rights and resources, water use, contamination sources, and groundwater characteristics.

No significant adverse changes are expected on site hydrology as a result of construction activities or operation of the IIFP plant; ER Section 4.4.7, "Control of Impacts to Water Quality," addresses potential for impacts on site water resources as a result of activities on the IIFP site including runoff and infiltration changes due to plant construction and fill placement.

3.4.1 Surface Hydrology

Surface drainage at the site is contained within a few local, intermittent playas that have no external drainage. There is also a small stream that runs from the northwest to the southeast across the property that is predominantly dry during the year. Essentially all the precipitation that occurs at the site is subject to infiltration and/or evapotranspiration. See Figure 3-25 which shows the typical water cycle for New Mexico.

Initially, all of New Mexico's surface water comes from precipitation, and the principal constraint on the water supply is climate. Much of New Mexico receives less than 10 inches of water per year. Most of the precipitation that falls evaporates within a short time of reaching the ground (or sometimes before). Of the precipitation that reaches land without evaporating, much is taken up and used by plants (called transpiration). The rest either flows across the land surface into rivers and streams, or percolates into the ground, where it recharges underground aquifers. The portion of New Mexico where precipitation exceeds the combination of evaporation and transpiration (called evapotranspiration) is limited to a few areas of high elevation during the cool months of the year. Surface water refers to all water located on the surface of the land—rivers, lakes and streams. New Mexico's surface water supply originates as rain or melting snow, but 97% of that water evaporates or is transpired by plants (NMBGMR, 2009).

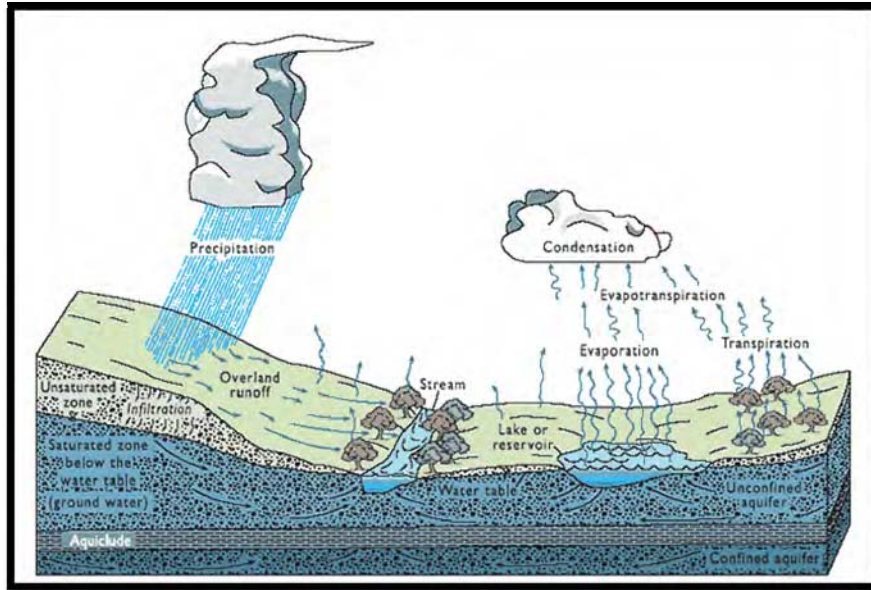

Source: NMBGMR, 2009

Figure 3- 25 Typical New Mexico Water Cycle

More information on the movement and fate of surface water and groundwater at the site is provided in ER Section 3.4.1.1. There are also several intermittent surface features in the vicinity of the IIFP site that may collect water for short periods of times following heavy rainfall events.

3.4.1.1 Major Surface and Subsurface Hydrological Systems

The Hobbs site sits on the Ogallala Aquifer. The Ogallala Aquifer, also known as the High Plains Aquifer, is a huge underground reservoir created millions of years ago that supplies water to the region which includes the proposed IIFP site. The aquifer extends under the High Plains from west of the Mississippi River to the east of the Rocky Mountains. The aquifer system underlies 174,000 square miles in parts of eight States (Colorado, Kansas, Nebraska, New Mexico, Oklahoma, South Dakota, Texas, and Wyoming). Figure 3-26 shows the Ogallala Aquifer and the proposed IIFP site. The Ogallala Aquifer, the largest groundwater system in North America, contains approximately 4 trillion m³ (3.3 billion acre-ft) of water. About 65% of the Ogallala Aquifer’s water is located under Nebraska (RRAT, 2004); about 12% is located under Texas; about 10% is located under Kansas; about 4% is located under Colorado; and 3.5, 2, and 2% are located under Oklahoma, South Dakota, and Wyoming, respectively. The remaining 1.5% [about 60 billion m³ (16 trillion gal)] of the water is located under New Mexico (PDWD, 2004).

The climate in southeast New Mexico is semi-arid. Precipitation in the area of the IIFP facility averages only 33 to 38 cm/yr (13 to 15 in/yr) (WRCC, 2006). Evaporation and transpiration rates are high which results in minimal, if any, surface water occurrence or groundwater recharge.

Surface drainage at the site is contained within two local playa lakes that have no external drainage. Runoff does not drain to one of the state’s major rivers. Surface water is lost through evaporation, resulting in high salinity conditions in the water and soils associated with the playas. These conditions are not favorable for the development of viable aquatic or riparian habitats. There are no designated FEMA Zone A areas that would be inundated during a 100-year flood event. See Figure 3-27, “Watercourses, Floodplains, and Playas Map.”

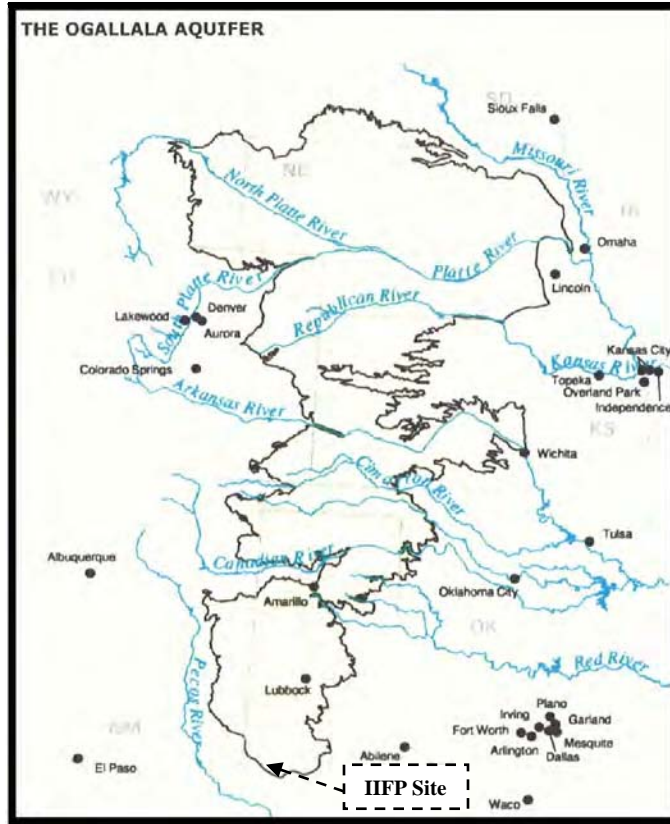

Source: HPWD, 2009

Figure 3- 26 Ogallala Aquifer

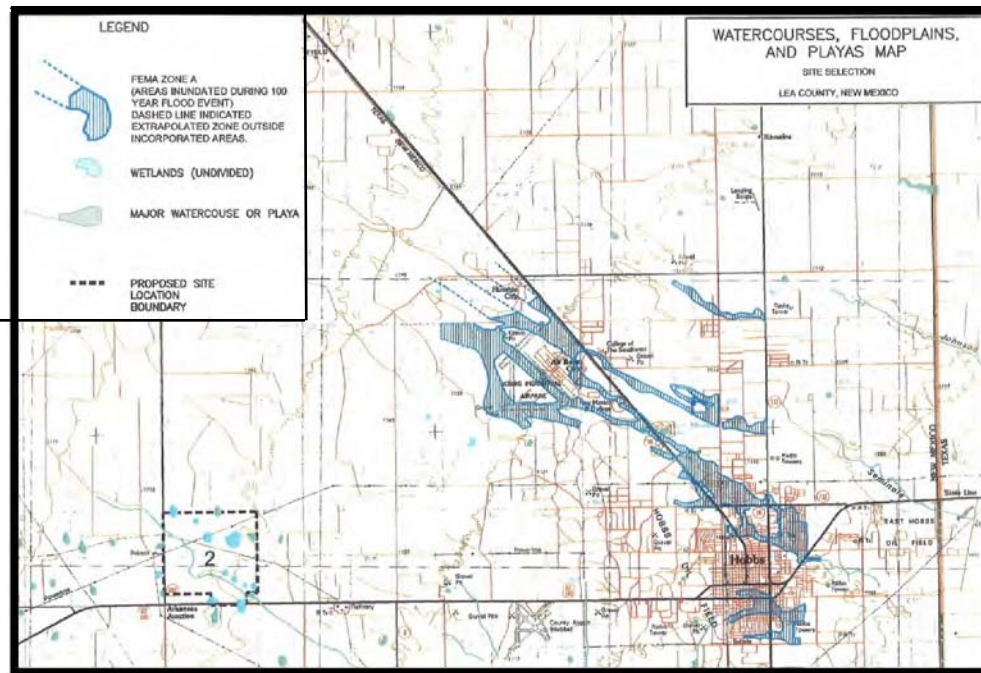

Source: EDCLC, 2008

Figure 3- 27 Watercourses, Floodplains, and Playas Map

Most precipitation is contained on site due to infiltration and/or evapotranspiration. The vegetation on the site is primarily shrubs and native grasses. The surface soils are predominantly of an alluvial or eolian origin. The texture of the surface soils is generally silt to silty sands. Therefore, the surface soils are relatively low in permeability and would tend to hold moisture in storage rather than allow rapid infiltration to depth. Water held in storage in the soil is subsequently subject to evapotranspiration. Evapotranspiration processes are significant enough to short-circuit any potential groundwater recharge.

3.4.1.2 Facility Withdrawals and/or Discharges to Hydrologic Systems

The IIFP plant will receive its water supply from 2 wells into the Ogallala Aquifer approximately 61 m (200 ft) beneath the surface. The IIFP facility water supply requirements are discussed in ER Section 4.4, “Water Resources Impacts.”

Two Stormwater Retention Basins will be utilized for the collection and containment of water discharges from the approximately 40-acre Site. The ultimate disposal of basin water will be through evaporation of water and impoundment of the residual dry solids after evaporation. It is designed to contain runoff for a 24-hour, 100-year return frequency storm, a 7.6-cm (3.0-in) rainfall. The IIFP facility design precludes operational process discharges from the plant to surface or groundwater at the site other than into engineered basins. Effluents unsuitable for the evaporative disposal will be removed off site by a licensed contractor in accordance with U.S. EPA and State of New Mexico regulatory requirements. The State of New Mexico has adopted the U.S. EPA hazardous waste regulations (40 CFR Parts 260 through 266, 268 and 270) (CFR, 2009v; CFR, 2009w; CFR, 2009x; CFR, 2009y; CFR, 2009z; CFR, 2009aa; CFR, 2009bb; CFR, 2009cc; CFR, 2009dd) governing the generation, handling, storage, transportation, and disposal of hazardous materials. These regulations are found in 20.4.1 NMAC, "Hazardous Waste Management" (NMAC, 2000).

A sanitary treatment system that includes tertiary treatment will be used to treat wastewater prior to its being reused in the plant or for landscape watering, as described in ER Section 4.1.1.2, “Utilities.”

3.4.2 Water Quality Characteristics

As discussed in ER Section 3.4.1.1, “Major Surface and Subsurface Hydrological Systems,” surface water resources in the area of the IIFP site are minimal. Runoff from precipitation at the site is effectively collected and contained by retention (evaporation) basins and through evapotranspiration. The IIFP site sits on the Ogallala Aquifer. See ER Section 3.4.15, “Groundwater Characteristics,” for water-quality testing results of local public water systems that obtain water from the aquifer as well as public supply wells on the aquifer.

3.4.3 Pre-Existing Environmental Conditions

There is no documented history of manufacturing, storage or significant use of hazardous chemicals on the IIFP property. Historically, the site has been used to graze cattle.

3.4.4 Historical and Current Hydrological Data

The IIFP facility is located in an area with little to no surface water or runoff. There are no near-by rivers or streams in the area that would be impacted by the facility. The occurrence of groundwater is also limited at the site.

3.4.5 Water Rights and Resources

The largest water use in Lea County is for non-municipal irrigation. The New Mexico Office of the State Engineer (NMOSE) has on record a total of 2,007 non-municipal wells with an associated water right of 425 million m³ (344,600 acre-ft). The next largest user group is municipalities, with water rights of 59 million m³ (48,000 acre-ft). The city of Hobbs is the largest water-rights holder with water rights of 24.8 million m³ (20,100 acre-ft) per year (LCWUA, 1999).

At various times, estimates of groundwater in storage have been made for the Ogallala Aquifer in Lea County. The estimates are made by assuming specific yields and saturated thickness. Groundwater in storage estimates are shown in Table 3-6. Not all groundwater in storage can be redrawn. About 40% of the total stored water in Lea County's portion of the Ogallala was considered recoverable for large-scale users. Because about 45% of the water in the basin is in areas where the saturated thickness is 140 feet or greater, it has been determined that 45% (approximately 14,000,000 acre-ft) of the water presently in storage can be recovered. It follows that approximately 8,000,000 acre-ft of recoverable water will exist in 2040 if a continuation of 1998 pumping rates occurs (LCWUA, 1999).

Table 3- 6 Ogallala Aquifer – Stored Water in Lea County

Aquifer Area (acres)	Average Specific Yield	Estimated Groundwater in Storage (acre-ft)	Recoverable Water (acre-ft)	Date	Reference
1,400,000	0.35	49,000,000	19,600,000 ^a	1952	Ash, 1963
1,500,000	0.20	48,000,000	21,600,000 ^b	1984	McAda, 1984
1,400,000	0.21	31,100,000	14,000,000 ^c	1995 to 1998	Calculated from Musharrafiieh and Chudnoff (1990)

^aAssumes 40% of water is recoverable.

^bAssumes 45% of water is recoverable.

^cCalculations are for the Lea County UWB. Other parts of the Ogallala in Lea County are insignificant.

Source: LCWUA, 1998

3.4.6 Quantitative Description of Water Use

Two wells will be drilled an average estimated distance of 61 m (200 ft) into the Ogallala Aquifer. The two wells will have the capacity to pump about 3.8 m³/min (1,000 gal/min). Average water usage is anticipated to be 11.36 m³/day (3,000 gal/day) to 17 m³/day (4,500 gal/day) with peak usage less than 37.85 m³/day (10,000 gal/day).

Water demand in Lea County increased 33% from 1985 to 1995 and in 1998, the demand was about 233.1 million m³ (189,000 acre-ft) per year. Similar increases in water use from 1985 to 1995 occurred in Irrigated Agriculture (33%) Public Supply (26%), Domestic (40%), Livestock (106%) and Commercial (21%) use categories. The water use by category, as a percentage of Lea County's total, is 78% Irrigated Agricultural, 10% for Public Water Supply, 7% Mining, and 3% Power. Present water use by Domestic, Livestock, Commercial Reservoir Evaporation, and Recreation uses are all less than 1% of the total use (LCWUA, 1999).

Over the next 40 years, if unrestrained, the water use in Lea County is estimated to increase to approximately 444.1 million m³ (360,000 acre-ft), 90% greater than the 1995 total. The largest part of this increase is anticipated to come from Irrigated Agricultural, which is projected to require 357.7 million m³ (290,000 acre-ft) in 2040, in response to demands for feed from Lea County's expanding dairy industry.

All other water use categories are expected to increase in Lea County over the next 40 years. Specifically, 55% Public Supply, 58% Domestic, 364% Livestock, 58% Commercial, 134% Industrial, 32% Mining, 57% Power, and 55% Recreation are estimated above 1995 uses. These other categories account for a total of approximately 86.3 million m³ (70,000 acre-ft) per year of the total annual 2040 estimate (LCWUA, 1999).

3.4.7 Non-Consumptive Water Use

Non-consumptive water use is water that is used and returned to its source and made available for other uses. The IIFP plant does not return any water directly to its source.

3.4.8 Contaminant Sources

In general, existing wells in Lea County are not impacted by groundwater contamination. As of 1998, the ability of area aquifers to supply wells in Lea County has been limited in only a few places by contamination. The activities that most commonly are sources of groundwater contamination in Lea County and the types of contamination associated with the activities are as follows:

- Petroleum Production Facilities; salts from oil well brine pits, hydrocarbons from leaks and spills.
- Agricultural Activities; residues from applied and stored pesticide and fertilizers.
- Wastewater Disposal Systems; leachate containing nitrogen from community wastewater treatment facilities and septic systems.
- Underground Storage Tanks; hydrocarbons from leaks and spills.
- Mines and Quarries; heavy metals.
- Industrial Facilities; chemicals and heavy metals.
- Landfills; leachate containing nitrogen, chemicals, and heavy metals.
- Livestock Industry; wastewater and runoff from dairies and feed lots.
- Radioactive Mineralization.

There will be no process water discharges to natural surface waters or groundwaters from the IIFP facility. The EPA reports (EPA, 2009c) that no Superfund (CERCLA) sites exist in the area near the IIFP site in Lea County, New Mexico.

Storm water runoff from the IIFP site is controlled during construction activities and operation. Appropriate storm water construction runoff permits for construction activities will be obtained before construction begins. Design of storm water run-off controls for the operating plant is described in Section 4.4. Storm water is collected during operations phase from appropriate site areas and routed to retention basins. These basins and the site stormwater system are described in ER Section 3.4.1.2.

3.4.9 Description of Wetlands

An evaluation of the site and of available wetlands information has been used to determine that the site does not contain jurisdictional wetlands or those areas subject to the regulations of the *Clean Water Act of 1977*. Jurisdiction wetlands are generally concave or low-lying topographic forms that collect, store, or flow water frequently enough to favor a majority of plants that are adapted to saturated soil conditions. There exist “undivided” wetlands as shown in Figure 3-27, “Watercourses, Floodplains, and Playas Map.”

3.4.10 Federal and State Regulations

ER Section 1.3 describes applicable regulatory requirements and permits. ER Section 4.4 describes potential site impacts as they relate to environmental permits regarding water use by the facility.

Applicable regulations for water resources include:

- National Pollutant Discharge Elimination System (NPDES)--The IIFP facility is eligible to claim the "No Exposure" exclusion for industrial activity of the NPDES storm water Phase II regulations. As such, IIFP would submit a No Exposure Certification immediately prior to initiating operational activities at the IIFP site. IIFP also has the option of filing for coverage under the Multi-Section General Permit (MSGP) because the IIFP facility is one of the 11 eligible industry categories (EPA, 2008). If this option is chosen, IIFP will file a Notice of Intent (NOI) with the EPA, Washington, D.C., at least two days prior to the initiation of IIFP operations. A decision regarding which option is appropriate for IIFP will be made in the future.
- NPDES--Construction General Permit for stormwater discharge is required because construction of the IIFP plant will involve the grubbing, clearing, grading or excavation of one or more acres of land. This permit is required prior to the proposed pre-licensing construction activities and will be administered by the EPA Region 6 with oversight review by the New Mexico Water Quality Bureau. Various land clearing activities such as off-site borrow pits for fill material are covered under this general permit. IIFP construction contractors will be clearing approximately 40 acres during the construction phase of the project. IIFP will develop a Storm Water Pollution Prevention Plan (SWPPP) and file a Notice of Intent (NOI) with the EPA, Washington, D.C., at least two days prior to the commencement of construction activities.

3.4.11 Surface Water Characteristics for Relevant Water Bodies

Stormwater from buildings, roofs, paved areas, and storage pads drained to retention basins. There are no drainage features that would transport surface water off site. Precipitation on site is either subject to infiltration, natural evapotranspiration, or facility system collection and evaporation.

3.4.11.1 Freshwater Streams, Lakes, Impoundments

Surface water within Lea County is limited to intermittent streams, lakes, and small playa lakes that result from heavy rainfall during May through October, when 80% of the yearly rainfall occurs. These intermittent surface water sources are used primarily for livestock purposes where small, manmade earthen structures have been constructed to collect surface runoff.

The IIFP site includes no freshwater streams or lakes. Impoundments to contain stormwater runoff will be constructed as part of the facility. These components are described in ER Section 3.4.1.2 "Facility Withdrawals and/or Discharges to Hydrologic Systems."

3.4.11.2 Flood Frequency Distributions

Site grade will be above the elevation of the 100-year and the 500-year flood elevations. Flood events or "Base Floodplains" are divided into two primary categories:

- 100-Year Floodplain: An area with a 1% chance to flood in any given year. A flood of magnitude occurs once every 100 years on the average. Within any one year period, there is a one-in-one

hundred chance of the occurrence of such a flood. Most importantly, however, the cumulative risk of flooding increases with time.

- 500-Year Floodplain: An area with a 0.2% chance to flood in any given year. A flood of magnitude occurs once every 500 years on the average. Within any one year period, there is a one-in-five hundred chance of the occurrence of such a flood. As with the 1% chance to flood, the cumulative risk increases with time.

3.4.11.3 Floodplain Description/Flood Control Measures

Site grade is above the elevation of the 100-year and the 500-year flood elevations. See Figure 3-27, “Watercourses, Floodplains, and Playas Map” for location of FEMA Zone A (areas inundated during 100-year flood event) northeast of the site or northwest of Hobbs, New Mexico around the Hobbs Industrial Air Park. The IIFP site storm system is designed to accommodate a 100-year return period precipitation event. No additional flood control measures are proposed for the IIFP facility.

3.4.11.4 Design-Basis Flood Elevation

Site grade is above the 500-year flood elevations.

3.4.11.5 Location, Size and Elevation of Outfall

The IIFP plant has no direct outfall to a surface water body. Runoff volume will not change from present levels due to site development or facility operation.

3.4.11.6 Velocity Distribution and Water-body Cross Section within Influence of Outfall

This is not applicable to the IIFP facility.

3.4.11.7 Bathymetry Near any Outfall

The IIFP plant has no outfall to a surface water body.

3.4.11.8 Erosion Characteristics and Sediment Transport

The IIFP plant has no outfall to a surface water body. Since runoff does not drain to one of the state’s major rivers, surface water is lost through evaporation.

3.4.12 Freshwater Streams for the Watershed Containing the Site

3.4.12.1 Major Streams

The nearest surface water is the Pecos River which is approximately 110 km (68 mi) west of the site. See Figure 3-13 for the location of the Pecos River in relation to the IIFP site. Like most rivers in New Mexico, the Pecos River is described as “extremely variable from year-to-year” (OSE, 2004) due to its dependence on runoff. The principle use of the Pecos River water is for agriculture. There are no perennial streams in Lea County.

3.4.12.2 Drainage Areas

In Lea County neither of the two major drainage basins, the Texas Gulf Basin in the north and the Pecos River Basin in the south, contain large-scale surface-water bodies or through-flowing drainage systems. The surface water supplies that exist are transitory and limited to quantities of runoff impounded in short drainage ways, shallow lakes, and small depressions, including various playas and lagunas. The Texas Gulf Basin contains lakes, the Llano Estacado, and the Simona Valley. The Pecos River Basin contains the Querecho Plains, the Eunice Plains, and the Antelope Ridge. Although southern Lea County is part of the Pecos River Basin, there is no connecting drainage to the Pecos River (LCWUA, 1998). Still, the Pecos River is the most significant surface water body in southeastern New Mexico.

In the Llano Estacado, the drainage areas of the numerous playas capture 80 to 90% of the area's rainfall (Musharrafieh and Chudnoff, 1999). Most of the playas average less than one-acre in area, but can be as large as 150 acres; depths range from 1 to 50 feet. The playas only temporarily impound water; clay accumulations in their bottoms retard percolation, resulting in extended seasonal or perennial impoundment during wet years. It is thought that many of the depressions may have been formed by leaching of the caliche cap and subsurface calcareous sandstones of the Ogallala Formation, with subsequent removal of the loosened material by wind. Deep-seated collapse of underlying strata has also been suggested as a mechanism for some playas. Surface interconnection of the wallows, particularly in the eastern part of the county, results in some poorly defined drainage patterns. The interconnections are possibly the result of original surface irregularities (LCWUA, 1998).

Surface drainage at the 640-acre Section is contained within several local playa lakes that have no external drainage. Runoff does not drain to Pecos River. The Pecos River Basin has a maximum basin width of 209 km (130 mi) and a drainage area of 115,345 km² (44,535 mi²).

3.4.12.3 Historical Maximum and Minimum River Flows

The Pecos River generally flows year-round. The main stem of the Pecos River and its major tributaries have low flows, and the tributary streams are frequently dry. Seventy-five percent of the total annual precipitation and 60% of the annual flow results from intense local thunderstorms between April and September (ELEA, 2007). The Pecos River is the closest river to the site. There are no rivers within the site.

3.4.12.4 Historical Drought River Flows

The Pecos River generally flows year round.

3.4.12.5 Important Short-Duration Flows

Seventy-five percent of the total annual precipitation and 60% of the annual flow results from intense local thunderstorms between April and September (ELEA, 2007). The USGS does not have gages in Lea County which measure daily surface flows. However, peak flow rates have been spot measured at Monument Draw (near Monument) and Antelope Draw (near Jal). Each of these Draws can occasionally convey sizable flows. In June of 1972, a flow of 1,280 ft³/sec (the highest recorded) occurred at Monument Draw. This flow should be considered indicative of flows that can occur at other gullies and swales in Lea County (LCWUA, 1999).

3.4.13 Lakes and Impoundments

There are two planned impoundments to contain stormwater runoff to be constructed as part of the facility. The capacities are described in ER Section 3.4.1.2.

3.4.13.1 Elevation-Area-Capacity Curves

In most of Lea County, the water table lies below a depth of 20 feet (LCWUA, 1998). Except for a few saline playa lakes and a northwest-to-southwest drainage, there are no surface water features on the IIFP Site. There is no surface water flow to any off-site river or impoundment; water is dissipated to the atmosphere by evapotranspiration.

3.4.13.2 Reservoir Operating Rules

The IIFP facility will not use any water from any natural reservoir.

3.4.13.3 Annual Yield and Dependability

The IIFP facility will not use any water from any natural reservoir.

3.4.13.4 Inflow/Outflow/Storage Variations

The IIFP facility will not discharge process water to any local water body; thus discharges will not affect water storage in any water body.

3.4.13.5 Net Loss, Including Evaporation and Seepage

Water loss through evaporation occurs from both the playas and lakes of Lea County. The playas on the High Plains (i.e. Llano Estacado) have been studied to determine the fate of impounded runoff. Some studies suggest that majority of the playas water is lost to evaporation, while others have found infiltration prevails. It is estimated that approximately 123.3 million m³ (100,000 acre-ft) of water accumulates in the playas, in years of normal precipitation, and that 20 to 80% of the impounded water infiltrates into the subsurface. If a maximum 18-inches per year evapotranspiration at ground level (with a linear decrease to nil at 20 feet below ground) is assumed, the average annual evaporation from shallow reservoirs can be calculated to be approximately 72 inches (Hale et. al, 1965) and evaporation rates in the playas may actually approach that of an evaporation pan device. Because of these high evaporation rates, the small lakes of northern Lea County, which intersect the water table, probably produce a net discharge of groundwater to the atmosphere (LCWUA, 1999).

The IIFP facility will not use or discharge process water to any local surface water body; thus it will not affect water flow or storage in any surface water body.

3.4.13.6 Current Patterns

The IIFP plant will not use or discharge process water to any local surface water body; thus it will not affect current patterns in any surface water body. The IIFP plant's water usage will not significantly impact groundwater patterns.

3.4.13.7 Temperature Distribution

The IIFP facility will not discharge process wastewater or non-contact cooling water to any local surface water body; thus it will not affect temperature in any surface water body.

3.4.14 Estuaries and Oceans

This is not applicable for the IIFP site since the nearest river is 110 km (68 mi) from the site and the Gulf of Mexico is over 813 km (505 mi) from Hobbs.

3.4.15 Groundwater Characteristics

The Hobbs site sits on the Ogallala Aquifer. The Ogallala Aquifer, also known as the High Plains Aquifer, is a huge underground reservoir created millions of years ago that supplies water to the region which will include the proposed IIFP site. The aquifer extends under the High Plains from west of the Mississippi River to the east of the Rocky Mountains. The aquifer system underlies 174,000 square miles in parts of eight States (Colorado, Kansas, Nebraska, New Mexico, Oklahoma, South Dakota, Texas, and Wyoming). Refer to Figure 3-26, "Ogallala Aquifer."

The Ogallala Aquifer, the largest groundwater system in North America, contains approximately 4 trillion m³ (3.3 billion acre-ft) of water. About 65% of the Ogallala Aquifer's water is located under Nebraska (RRAT, 2004); about 12% is located under Texas; about 10% is located under Kansas; about 4% is located under Colorado; and 3.5%, 2%, and 2% are located under Oklahoma, South Dakota, and Wyoming, respectively. The remaining 1.5%—or about 60 billion m³ (48.6 million acre-ft)—of the water is located under New Mexico (PDWD, 2004).

Approximately 20% of the irrigated land in the United States is in the High Plains, and about 30% of the groundwater used for irrigation in the United States is pumped from the Ogallala Aquifer. Irrigation accounts for about 94% of the daily aquifer use of more than 60 million m³ (48,600 acre-ft). Irrigation withdrawals in 1990 were greater than 53 million m³ (43,000 acre-ft) daily. Domestic drinking is the second largest groundwater use with the High Plains States, amounting to about 2.5% of 1.6 million m³ (1,300 acre-ft) of total daily withdrawals. In 1990, 2.2 million people were supplied by groundwater from the Ogallala Aquifer with total public-supply withdrawals of 1.43 million m³ (1,200 acre-ft) per day (USGS, 2004b). Withdrawals from the aquifer exceed recharge to it, so the Ogallala Aquifer is being depleted. The amount of water in storage in the aquifer in each state depends on the actual extent of the formation's saturated thickness.

Table 3-7 lists recent water-quality testing results of local (Hobbs and Eunice) public water systems and public supply wells that obtain water from the Ogallala Aquifer. The waters of the Ogallala, while very hard, are consistently good quality and can be used for a variety of activities, including public supply and irrigation (LCWUA, 2000).

3.4.15.1 Groundwater Elevation Trends

Groundwater resources in Lea County include hydrogeologic strata within five underground water basins identified by the New Mexico Office of the State Engineer (NMOSE). The basins from north to south are the Lea County Underground Water Basin (UWB), a very small portion of the Roswell UWB, the Capitan UWB, the Carlsbad UWB, and the Jal UWB.

Table 3- 7 Ogallala Aquifer Annual Water Quality Averages for Hobbs and Eunice, New Mexico

Parameter	Units	Hobbs ¹	Public Supply Wells ²	Eunice ¹	EPA Maximum Contaminant Levels
Alkalinity—Total	mg/l	163 ^a	188	186.5	N/A
Color		not detected		0.25	250 ^g
Specific Conductivity	mhos/cm	839.9	1,004	716.8	N/A
Hardness	mg/l	293.3	303	248	N/A
pH	standard	7.5		7.2	6.5 to 8.5
Turbidity	NTU	not detected		1.0	N/A
Total Dissolved Solids	mg/l	410.0	768	415.7	500 ^g
Arsenic	mg/l	0.008		0.008 ^d	0.01 (as of 1/3/06)
Calcium	mg/l	80.7	75	80.5	N/A
Chloride	mg/l	114.0	59	63.4	250 ^g
Fluoride	mg/l	1.1	2.3 to 3.2	1.0 ^e	4.0
Iron	mg/l	0.05		<0.25 ^f	0.3
Magnesium	mg/l	44.4	28	11.5	4.0
Mercury	mg/l	not detected		<0.0002 ^d	N/A
Nitrate	mg/l	3.8		2.6	10
Potassium	mg/l	3.4 ^a	11	4.8	
Sodium	mg/l	38.0	67	42.6	N/A
Sulfate	mg/l	113.1 ^b	118 to 291	67.2	
Gross Alpha	pCi/l	3.1 ± 0.9 to 16.6 ± 2.9 ^c	6.6 to 16.2	2.8 ± 1 to 6.6 ± 1 ^c	15

¹ Source: LCWUA, 2000

² Source: LCWUA, 1999

N/A – not applicable; mg/l – milligrams per liter; NTU – Nephelometric Turbidity Units; pCi/l – picocuries per liter; • mhos/cm – micromhos per centimeter

^aSampled at entry point, August 23, 2004

^bSampled at entry point, February 1996

^cRange in concentration, low and high; sampled from 1994 through 1997

^dSampled at entry point, March 1995

^eSampled at entry point, March 1996

^fSamples taken from 1975 to 1979

^gResults are either annual averages for all wells in a system, at the entry point of a system, or averages of all wells in a system for a particular sampling date.

The Lea County UWB is approximately 2,180 square miles in size. The Lea County UWB extends east to west across the width of Lea County and generally terminates to the south along the Mescalero Ridge and its associated escarpment. The primary aquifer of the Lea County UWB, as well as the primary groundwater source in Lea County, is the Ogallala Aquifer. The maximum saturated thickness of the Ogallala Aquifer in the Lea County UWB is approximately 250 feet (LCWUA, 1998).

Groundwater in the Basin is being pumped out at a faster rate than it is being recharged. Historic water level declines from pumping near Hobbs and along the New Mexico-Texas state line are as great as 50 to 70 feet. The annual groundwater diversion in Lea County in 1995 was about 222 million m³ (180,000 acre-ft) per year, the majority of which was from the Lea UWB. Groundwater diversions from Lea

County are projected to more than double by the year 2040, primarily in response to increased agricultural demands for the dairy industry (LCWUA, 1998).

The IIFP plant will withdraw groundwater from the Ogallala Aquifer at a average rate of approximately 11.36 m³/day (3,000 gal/day) to 17 m³/day (4,500 gal/day) The usage equates to a maximum of 5 acre feet/year, which is insignificant when compared with the NMOSE having on record a total of 2,007 non-municipal wells with a water use of 178,522 acre-feet in 1998, as shown in Table 3-8. Other industries used 2,524 acre-feet of water, while mining accounted for 12,439 acre-feet of water use in 1998 (LCWUA, 1998).

Table 3- 8 Lea County Historical Water Use

Water Use Category	1975 (ac-ft)	1985 (ac-ft)	1995 (ac-ft)	1998 ^a (ac-ft)	Change 1975-1985 (%)	Change 1985-1995 (%)	Change 1995-1998 ^b (%)
Public Water Supply	9,966	12,818	16,153	17,790	+29	+26	+10
Domestic	714	949	1,331	n/a ^d	+33	+40	n/a
Irrigated Agricultural	191,290	98,409	131,163	138601 ^e	-49	+33	+6
Livestock	1,025	727	1,497	1,111 ^f	-29	+106	-26
Commercial	555	1,111	1,436	606	+100	+21	-55
Industrial	No report	0	1,497	2,524 ^g	n/a	n/a	+69
Mining	21,612	25,783	18,975	12,439 ^h	+19	-26	-34
Power	13,876	5,708	4,445	4,485	-59	-22	<1
Reservoir Evaporation	100	0	0	0	-100	0	0
Recreation	0	887	No report	966 ⁱ	n/a	n/a	n/a
Total Use	239,138	146,392	176,407	178,522	-39	+21	+1

Source: LCWUA, 1997

^a Data for 1998 is incomplete. Figures are based on withdrawals from the Lea County UWB only.

^b Actual increases and decreases for this period are yet to determined due to incomplete NMOSE data.

^c The value includes 1,608 ac-ft of commercial, domestic, and industrial use by the City of Carlsbad and 725 ac-ft of municipal non-cities use.

^d Domestic use has not been estimated.

^e This figure reflects an estimated area of 83,500 acres irrigated at 1.6 ac-ft plus metered irrigation at 5,001 ac-ft.

^f This value includes dairies and cattle feed lots, but does not include livestock use in the Jal or Capitan UWBs.

^g This figure includes manufacturing and petroleum processing.

^h This value includes secondary recovery of oil, mining or ore, and oil well dwellings.

ⁱ Recreation was eliminated as a separate category by the MNOSE Technical Report 47

3.4.15.2 Water Table Contours

The maximum saturated thickness of the Ogallala Aquifer in Lea County is approximately 250 feet. The primary uses of groundwater from Lea County are irrigation and public water supply. The cities and towns of Hobbs, Lovington, and Tatum have municipal well fields that withdraw potable water from the Ogallala aquifer.

Figure 3-28 is a map of the water-level changes in the High Plains aquifer from predevelopment to 2005 based on water levels from 3,682 wells. Predevelopment refers to the time prior to substantial ground water irrigation development, which occurred around 1950. The water-level changes from predevelopment to 2005 ranged between a rise of 84 feet and a decline of 277 feet. Area-weighted, average water-level change was a decline of 12.8 feet. Approximately 25% of the aquifer area had more

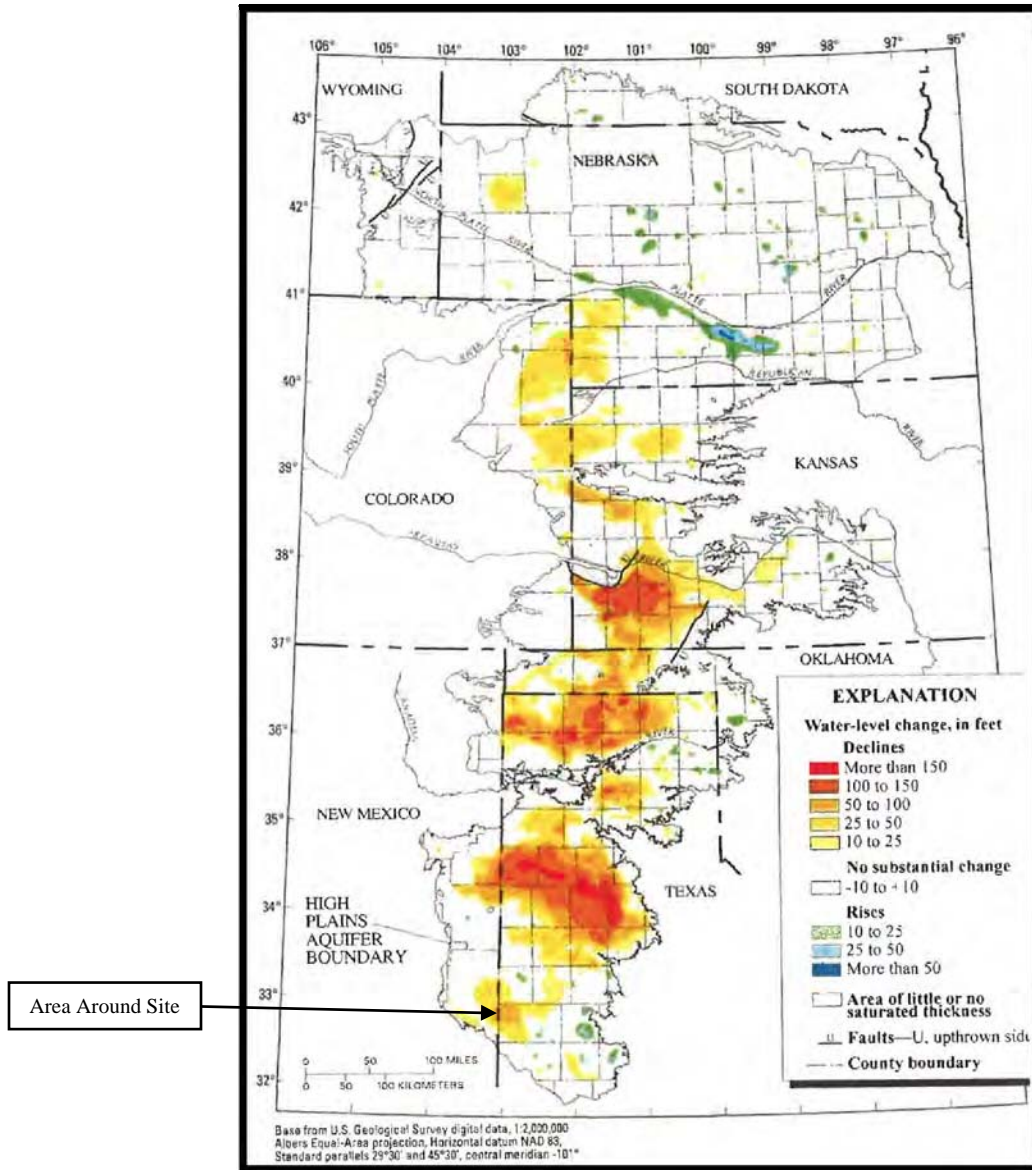

Figure 3- 28 Water-Level Changes in the Ogallala Aquifer, Predevelopment to 2005

than 10 feet of water-level decline from predevelopment to 2005; 17% had more than 25 feet of water-level decline; and 9% had more than 50 feet of water-level decline (McGuire, 2007). Hobbs, New Mexico experienced a decline of more than 25 feet of water in that same time frame.

The Pecos River carved its present valley in Eddy County thousands of years ago during Quaternary time. In doing so, the river isolated both the Ogallala Formation and the Dockum Group sediments in Lea County from their ancient upland recharge areas. Groundwater flow in these aquifers attained a balance with the more limited recharge provided by the High Plains Aquifer. Since the advent of large-scale groundwater developments in the early to mid part of this century, this equilibrium has been lost. Aquifer levels in Lea County are now declining as groundwater is withdrawn from storage (LCWUA, 1999).

3.4.15.3 Depth of Water for Unconfined Aquifer Systems

The depth to water ranges from about 20 feet near Monument and the Four Lakes area to about 250 feet along the edge of Mescalero Ridge. Saturated thickness of the aquifer ranges from a few feet along the northeast portion of the UWB and along portions of the Mescalero Ridge to about 250 feet near the Texas State Line (LCWUA, 1998).

Pumping for irrigation, municipal supply, domestic use, industrial use, and stock causes a large artificial discharge. Because pumping is in excess of the Ogallala's recharge rate, the elevation of the top of the aquifer has declined or experienced drawdown. A groundwater flow model (Musharrafieh and Chudnoff, 1999) indicated that, in response to heavy pumping in Texas, the most severe drawdown occurred along Lea County's east border, the Texas Line. In this area, drawdowns in excess of 80 feet have occurred since 1940. The model predicts that the saturated thickness will decrease another 50 to 100 feet in the area between the state line and the communities of Hobbs, Lovington, and Tatum in the next 40 years (LCWUA, 1999).

3.4.15.4 Soil Hydrologic Properties

The hydraulic conductivity reported for various portions of the Ogallala Aquifer in Lea County UWB has been evaluated by a number of different authors using different techniques. The techniques include aquifer tests and laboratory analysis and model calibrations. Values reported range from 3 to 262 ft/day.

Reported values from groundwater models indicate areas with higher hydraulic conductivity near the central portion of the basin, between Tatum and Lovington--eastward to the Texas border and near Hobbs--eastward to the Texas border. Specific yields reported range from 0.10 to 0.28%. Specific yield for an unconfined aquifer is the volume of water that will drain from a unit of surface area per unit of decline (LCWUA, 1998).

3.4.15.5 Flow Travel Time: Groundwater Velocity

Potentiometric surface elevation data from 1952 indicate the groundwater flow direction was about 30 degrees south of east, with a gradient of 15.8 feet/mile in the north and central Lea County. Potentiometric elevation data for 1968 show the direction of groundwater was southeast and the gradient average about 15 feet/mile. Changes in the potentiometric surface elevations from 1952 to 1968 indicate decreasing water levels throughout much of the Ogallala. Potentiometric data from 1981 indicate only small changes in water levels for the period; the direction of flow was southeast, and the gradient average about 13.7 feet/mile. Potentiometric data for the combined years 1995 to 1998 indicate only small changes in water levels; the direction of groundwater flow was southeast and the gradient was about 13 feet/mile (LCWUA, 1998).

Pumping in Texas, along the Texas-New Mexico State Line, is in large part responsible for more than 80 feet of localized declines in the water level since 1940. Continued pumping along the state line will continue to drop the water level and increase the hydraulic gradient in the area. Estimated flows across the New Mexico-Texas Line have been calculated and are shown in Table 3-9 (LCWUA, 1999).

Table 3- 9 Flow across the New Mexico-Texas Border

Time Period	Saturated Thickness Length Along NM-TX Line, in Miles	Flow in Acre-Feet/Year
1967-1968	61.9	59,005
1981	61.9	45,694
1995-1998	61.9	48,729

Source: LCWUA, 1999 Estimated from Hydraulic Conductivity Values

Diagrammatic representation of modern groundwater flow patterns in the Delaware Basin area is shown in Figure 3-29. Red band represents the Capitan shelf margin facies. Black arrows show fluid flow directions prior to incision of the Pecos River and before modern-day groundwater withdrawal and oil development. Thickness of arrows is proportional to volume of water flow. Contours show concentration of total dissolved solids (in ppt or thousands of parts per million) in waters moving across the basin in the Capitan-equivalent upper Bell Canyon Formation (Scholle, 1992).

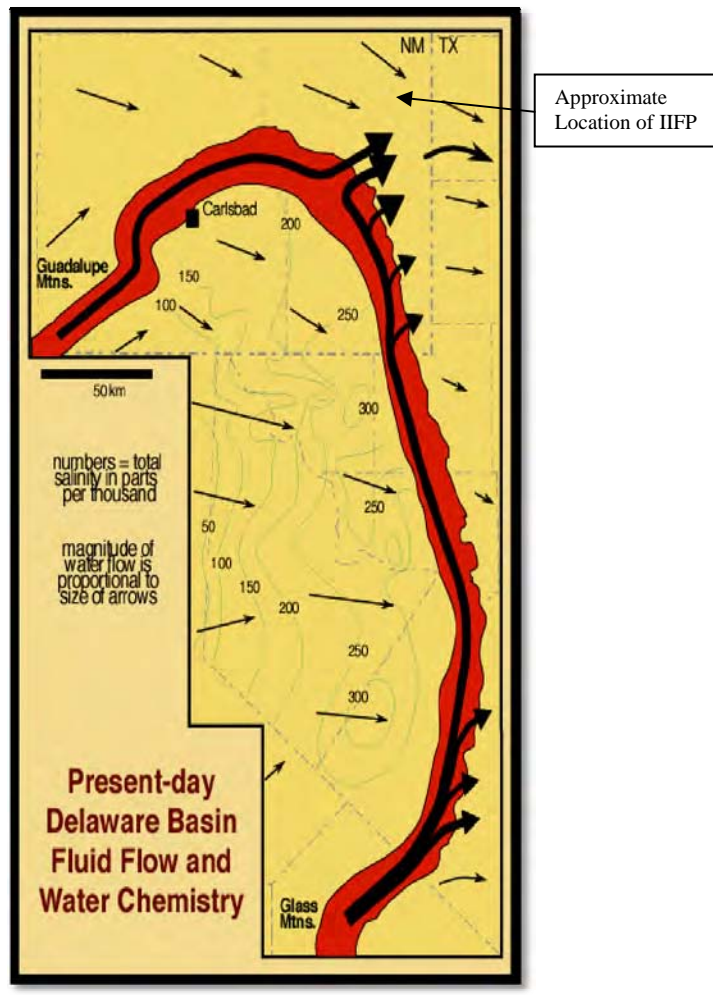

Source: Scholle, 1992

Figure 3- 29 Present-day Delaware Basin Fluid Flow and Water Chemistry

3.4.15.6 Interactions Among Different Aquifers

Groundwater resources in Lea County include hydrogeologic strata within five underground water basins declared by the New Mexico Office of the State Engineer (NMOSE). The basins from north to south are the Lea County Underground Water Basin (UWB), a very small portion of the Roswell UWB, the Capitan UWB, the Carlsbad UWB, and the Jal UWB. Groundwater in the Lea County UWB is being pumped out at a faster rate than it is being recharged. The Jal UWB is the smallest in Lea County and is the only other basin in the County that provides water for municipal use along with the Lea County UWB. Historic ground water diversions from the Jal basin have had little impact on water levels, indicating that recharge is about in equilibrium with the amount of water being removed by pumping. Water use in the other UWBs in the County is fairly limited because aquifers are unable to provide adequate quantities of water to wells for large users (LCWUA, 1998).

3.4.15.7 Historical and Current Data from Site Wells

Four irrigation wells are on the IIFP site. See Figure 3-30, “Water Wells Located on the Proposed IIFP Site” for locations of these irrigation wells. For the well in the upper left quadrant, the depth to water (DTW) is 16.8 m (55 ft) and the total depth (TD) is 50 m (164 ft). The well in the lower left quadrant has a DTW of 21.3 m (70 ft) and TD of 57.9 m (190 ft). The irrigation well in the upper right quadrant possesses a DTW of 16.8 m (55 ft) and a TD of 60.4 m (198 ft). The other well on the site in the lower right quadrant has a DTW of 21.3 m (70 ft) and a TD of 54 m (177 ft).

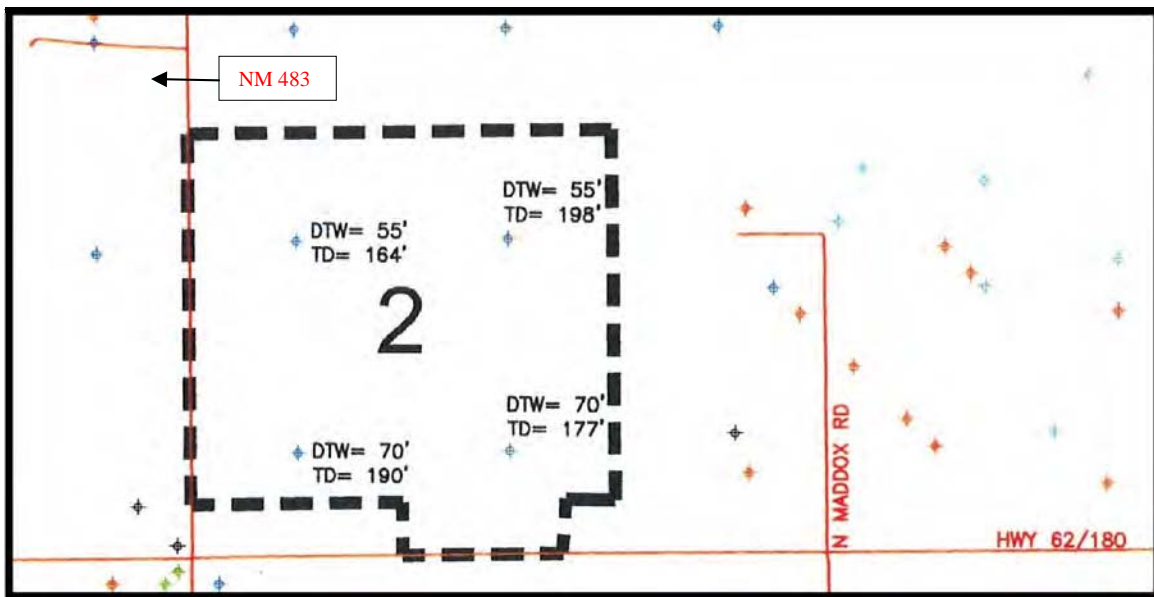

Figure 3- 30 Water Wells Located on the Proposed IIFP Site

3.5 Ecological Resources

This section describes the terrestrial and aquatic communities of the proposed IIFP site. This section is intended to provide a baseline characterization of the site's ecology prior to any disturbances associated with construction or operation of the IIFP plant. Prior environmental disturbances (e.g., roads and pipeline right-of-ways) not associated with the facility and their impacts on the site ecology, are considered when describing the baseline condition.

A single major community has been identified at the IIFP site: the Plains and Great Basin Grasslands. The plant and animal species associated with this major community are identified and their distributions are discussed. Those species that are considered important to the ecology of the site are described in detail.

Once the significant species were identified, their interrelationship with the environment was described. To the extent possible, these descriptions include discussions of the species habitat requirements, life history, and population dynamics. Also, as part of the evaluation of important species at the site, pre-existing environmental conditions, that may have impacted the ecological integrity of the site and affected important species, are considered.

3.5.1 Maps

Figure 3-31 “Topographical Map of Area around IIFP Site at Arkansas Junction”

Figure 3-32, “Grasslands of National Forest Systems New Mexico, Oklahoma, and Texas”

Figure 3-37, “Lesser Prairie Chicken Historic and Current Distribution”

Figure 3-40, “Expected Range of the Sand Dune Lizard”

3.5.2 General Ecological Conditions of the Site

Figure 3-31 is a topographical map showing the features from Hobbs to the site at Arkansas Junction. For a close-up view of the site, see Figure 3-3. Surface drainage at the site is contained within a few, intermittent local playas that have no external drainage. Since runoff does not drain to one of the state’s major rivers, surface water is lost through evaporation, resulting in high salinity conditions in the water and soils associated with the playas. These conditions are not favorable for the development of viable

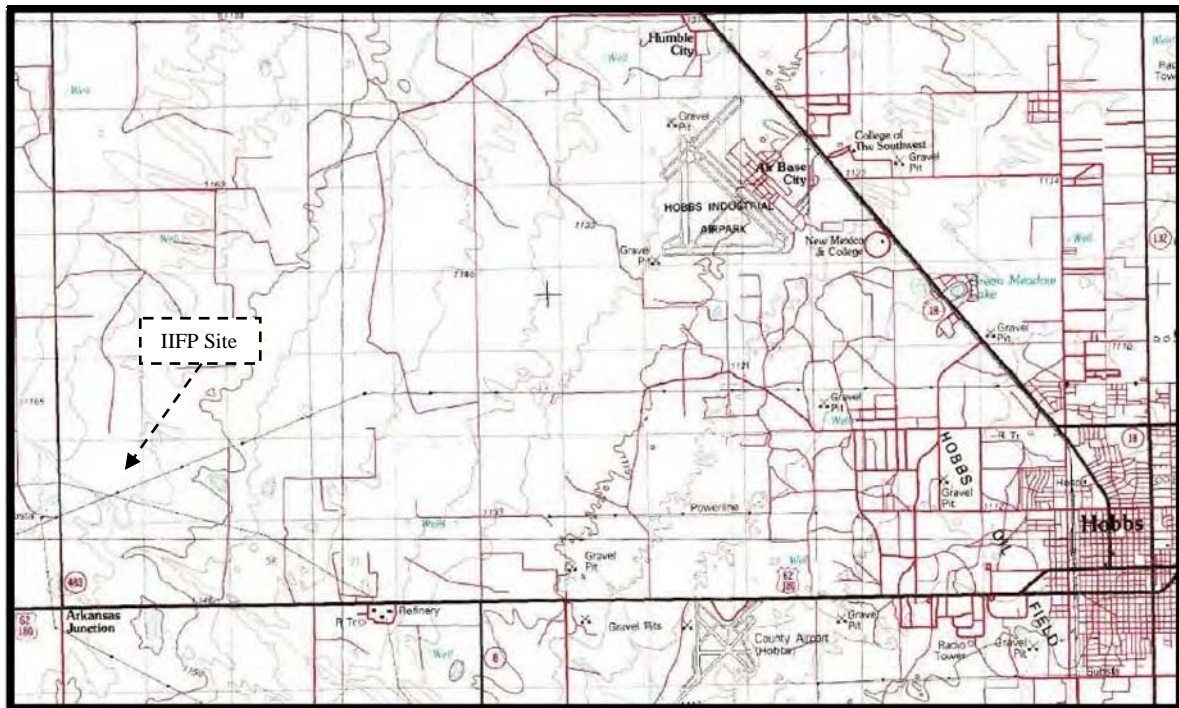

Figure 3- 31 Topographical Map of Area around IIFP Site at Arkansas Junction

aquatic or riparian habitats. There is also a small stream that runs from the northwest to the southeast across the property that is predominantly dry during the year.

Different life-form zones exist within Lea County. As with the other geography and landscape features, the life forms, both plant and wildlife, are separated by the Mescalero Ridge (Refer to Figure 3-15). Also see Figure 3-32, “Grasslands of National Forest Systems New Mexico, Oklahoma, and Texas,” to see this distinct separation. The area is a transitional zone between the short-grass prairie of the north of the Mescalero Ridge (Southern High Plains) and the desert communities south of the Mescalero Ridge (Chihuahuan Desert Scrub). The vegetation in this area is dominated by deep sand tolerant or deep sand adapted plant species. The vegetation community at the IIFP site has probably remained stable over the past 150 years since the introduction of domestic livestock grazing in the area by settlers from the eastern plains. By the mid-nineteenth century, there had already been a reduction of grasslands in the region by livestock herds associated with Spanish settlements along the Rio Grande River and Pecos River valleys. The site has been impacted by farming or oil and gas development which is prevalent in the region.

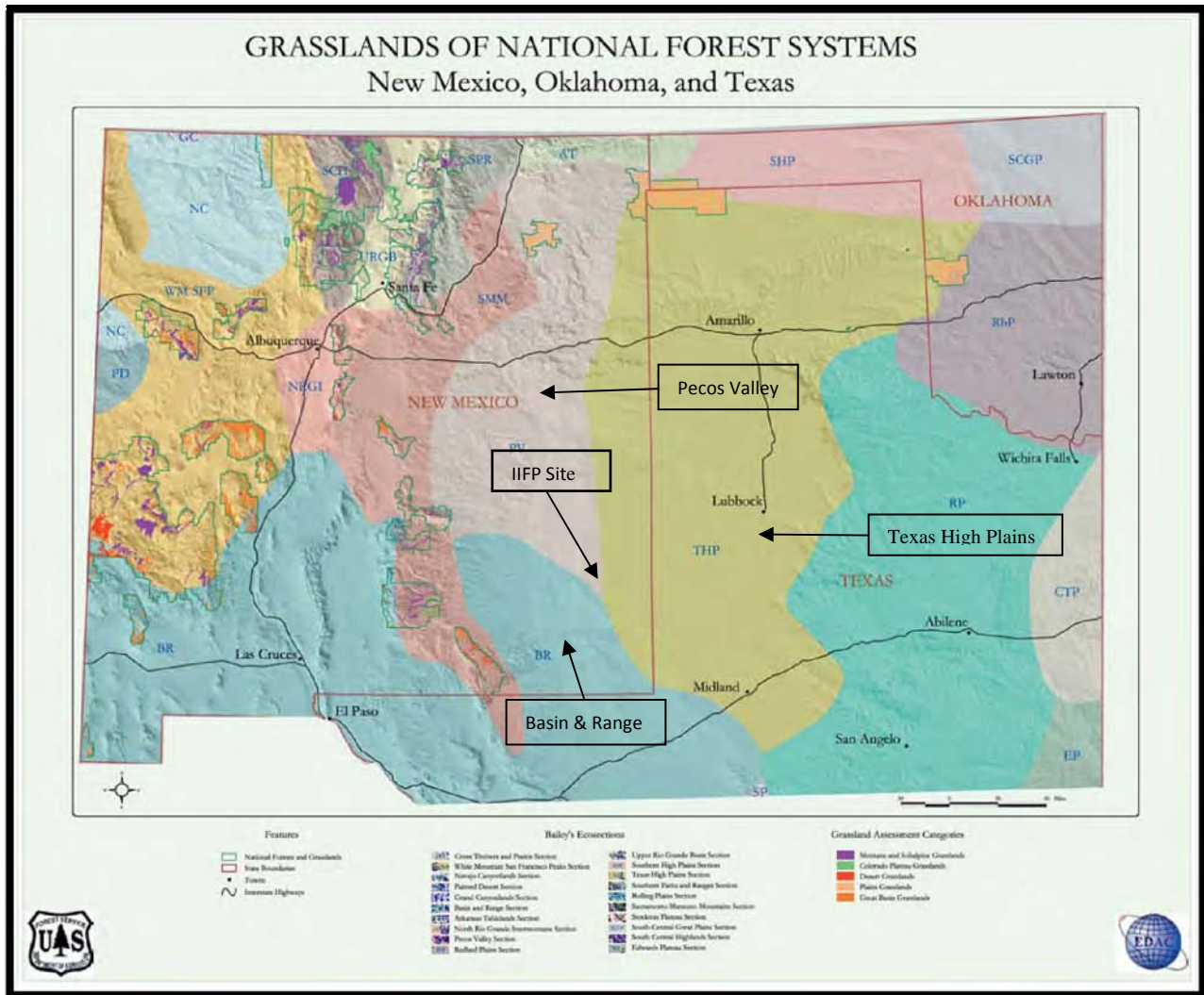

Figure 3- 32 Grasslands of National Forest Systems New Mexico, Oklahoma and Texas

The species composition of the wildlife community at the IIFP site is a direct function of the type, quality, and quantity of habitat that exists at the site and in the surrounding area. No site survey has been conducted on the IIFP site. Based on information on regional and local distribution of wildlife species and on species-specific habitat preferences, the wildlife species likely to occur at the IIFP facility can be identified. See Table 3-10, "Mammals, Birds, and Amphibians/Reptiles Potentially Inhabiting the Proposed IIFP Site and Vicinity, and Their Habitat and Seasonal Preferences." The mammals, birds, amphibians and reptiles expected to occur on the IIFP site are discussed below.

Because the IIFP site is in a transitional zone, wildlife species at the IIFP site are typical of species that occur in grassland habitats and desert habitats. Mammalian species common to this area of southeastern New Mexico include mule deer, pronghorn antelope, desert cottontail, black-tailed jackrabbit, plains pocket gopher, deer mouse, prairie vole, kangaroo rat, coyote, black-tailed prairie dog, collared peccary or javelin, striped skunk, and gray fox. Several species of bats that occur in the area include the Mexican freetailed bat and the pallid bat.

Common game birds include the mourning dove, bobwhite quail, and scaled quail. Other birds common to the area include scissor-tailed flycatcher, nighthawk, roadrunner, and the turkey vulture. Raptors include red-tailed hawk and barn owl. Reptiles include the western diamondback rattlesnake, eastern fence lizard, western box turtle, and the Great Plains Skink (Benyus, 1989).

Because the vegetative community at the site is in a stable, near climax, successional stage significant changes in habitat or mammalian species are not anticipated. The species listed were selectively chosen as those likely to live in or visit the region. Of these, approximately 18 species are likely to be summer residents, many of which may nest on the site. Approximately 15 of the species are probable winter residents of the site. A site-specific avian survey has not been conducted on the site. Future site-specific avian surveys will be conducted at appropriate times of the coming years.

Because the occurrence of amphibian species is closely related to water and the IIFP site contains no permanent natural surface water sources; there are very few associated amphibian species.

3.5.3 Major Vegetation Characteristics

The general vegetation community type that the subject property is located in is classified as Plains and Great Basin Grasslands. The community is further characterized by the presence of forbs, shrubs, and grasses that are adapted to the deep sand environment that occurs in parts of southeastern New Mexico.

The Plains Grasslands north of the Mescalero Ridge on the eastern portion of the Lea County consist of the short-grass, mid-grass, and tall-grass prairies of the National Grasslands. These grasslands extend throughout the Great Plains physiographic province and occur within the Southern High Plains, Pecos Valley, Redbed Plains, and Texas High Plains eco-region sections. Climate ranges from subhumid to semiarid as these grasslands extend from east to west. The characteristic plant species that are abundant throughout the short-grass prairie include blue grama and buffalo grass. The mid-grass prairie ecosystem is co-dominated by little bluestem, blue grama, and plains bristle grass. The tall-grass prairie is dominated by big bluestem. These different prairie ecosystems are aggregated and reduced to one category for this assessment and reflects a wide range of ecological properties and processes (USDA, 2004).

Table 3- 10 Mammals, Birds, and Amphibians/Reptiles Potentially Inhabiting the Proposed IIFP Site and Vicinity, and Their Habitat or Seasonal Preferences

Common Name	Scientific Name	Preferred Habitat
Mammals		
Black-Tailed Jackrabbit	<i>Lepus californicus</i>	Grasslands and open areas
Black-Tailed Prairie Dog	<i>Cynomys ludovicianus</i>	Short prairie grass
Cactus Mouse	<i>Peromyscus eremicus</i>	Grasslands, prairies, and mixed vegetation
Collared Peccary	<i>Dicotyles tajacu</i>	Brushy, semi-desert, chaparral, mesquite, and oaks
Coyote	<i>Canis latrans</i>	Open space, grasslands, and brush country
Deer Mouse	<i>Peromyscus maniculatus</i>	Grasslands, prairies, and mixed vegetation
Desert Cottontail	<i>Sylvilagus audubonii</i>	Arid lowlands, brushy cover, and valleys
Mule Deer	<i>Odocoileus hemionus</i>	Desert shrubs, chaparral, and rocky uplands
Ord's Kangaroo Rat	<i>Dipodomys ordii</i>	Hard desert soils
Plains Pocket Gopher	<i>Geomys bursarius</i>	Deep soils of the plains
Pronghorn Antelope	<i>Antilocapra Americana</i>	Sagebrush flats, plains, and deserts
Raccoon	<i>Procyon lotor</i>	Brushy, semi-desert, chaparral, and mesquite
Southern Plains Woodrat	<i>Neotoma micropus</i>	Grasslands, prairies, and mixed vegetation
Spotted Ground Squirrel	<i>Spermophilus spilosoma</i>	Brushy, semi-desert, chaparral, mesquite, and oaks
Striped Skunk	<i>Mephitis mephitis</i>	All land habitats
Swift Fox	<i>Vulpes velox</i>	Rangeland short grasses and low shrub density
White-Throated Woodrat	<i>Neotoma albigula</i>	Grasslands, prairies, and mixed vegetation
Yellow-faced Pocket Gopher	<i>Pappogeomys castanops</i>	Deep soils of the plains
Common Name	Scientific Name	Seasonal Preference
Birds		
American Kestrel	<i>Falco sparverius</i>	Summer
Ash-Throated Flycatcher	<i>Myiarchus cinerascens</i>	Summer
Bewick's Wren	<i>Thyromanes bewickii</i>	Spring
Black-Chinned Hummingbird	<i>Archilochus alexandri</i>	Year round
Blue Grosbeak	<i>Guiraca caerulea</i>	Summer and winter
Bullock's Oriole	<i>Icterus bullockii</i>	Summer
Cassin's Sparrow	<i>Aimophila cassinii</i>	Spring
Cactus Wren	<i>Campylorhynchus brunneicapillus</i>	Spring
Chihuahuan Raven	<i>Corvus cryptoleucus</i>	Rare
Common Raven	<i>Corvus corax</i>	Summer and winter
Crissal Thrasher	<i>Toxostoma dorsale</i>	Summer and winter
Eastern Meadowlark	<i>Sturnella magna</i>	Spring
European Starling	<i>Sturnus vulgaris</i>	Spring
Gambel's Quail	<i>Lophortyx gambelii</i>	Rare
Great-Tailed Grackle	<i>Quiscalus mexicanus</i>	Spring
Green-Tailed Towhee	<i>Pipilo chlorurus</i>	Migrant
House Finch	<i>Carpodacus mexicanus</i>	Summer and winter

Birds(Continued)		
Common Name	Scientific Name	Preferred Habitat
Killdeer	<i>Charadrius vociferous</i>	Year round
Lark Bunting	<i>Calamospiza melanocorys</i>	Winter
Lark Sparrow	<i>Chondestes grammacus</i>	Summer
Lesser Prairie Chicken	<i>Tympanuchus pallidicinctus</i>	Rare
Loggerhead Shrike	<i>Lanius ludovicianus</i>	Uncommon
Long-Eared Owl	<i>Asio otus</i>	Summer and winter
Mallard	<i>Anas platyrhynchos</i>	Summer
Mourning Dove	<i>Zenaida macroura</i>	Summer and winter
Nighthawk	<i>Chordeiles minor</i>	Summer and winter
Northern Mockingbird	<i>Mimus polyglottos</i>	Summer
Northern Bobwhite	<i>Colinus virginianus</i>	Summer and winter
Pyrrhuloxia	<i>Cardinalis sinuatus</i>	Uncommon
Red-Tailed Hawk	<i>Buteo jamaicensis</i>	Summer and winter
Red-Winged Blackbird	<i>Agelaius phoeniceus</i>	Spring
Roadrunner	<i>Geococcyx californianus</i>	Summer and winter
Sage Sparrow	<i>Amphispiza belli</i>	Summer and winter
Scaled Quail	<i>Callipepla squamata</i>	Summer and winter
Scissor-Tailed Flycatcher	<i>Tyrannus forficatus</i>	Migrant
Scott's Oriole	<i>Icterus parisorum</i>	Summer and winter
Swainson's Hawk	<i>Buteo swainsoni</i>	Summer
Turkey Vulture	<i>Cathartes aura</i>	Winter migrant
Vermilion Flycatcher	<i>Pyrocephalus rubinus</i>	Winter migrant
Vesper Sparrow	<i>Pooecetes gramineus</i>	Spring
Western Burrowing Owl	<i>Athene cunicularia hypugea</i>	Uncommon
Western Kingbird	<i>Tyrannus verticalis</i>	Summer
Amphibians/Reptiles		
Coachwhip	<i>Masticophis flagellum</i>	Mixed-grass prairie and desert grasslands
Collared Lizard	<i>Crotaphytus collaris</i>	Desert grasslands
Eastern Fence Lizard	<i>Sceoporus undulates</i>	Mixed-grass prairie and desert grasslands
Garter Snake	<i>Thamnophis Sp.</i>	Desert grasslands
Ground Snake	<i>Sonora semiannulata</i>	Desert grasslands
Longnose Leopard Lizard	<i>Gambelia wislizenii</i>	Mixed-grass prairie and desert grasslands
Lesser Earless Lizard	<i>Holbrookia maculate</i>	Mixed-grass prairie and desert grasslands
Longnosed Snake	<i>Rhinocheilus lecontei</i>	Desert grasslands
Ornate Box Turtle	<i>Terrapene ornate</i>	Desert grasslands and short-grass prairie
Pine-Gopher Snake	<i>Pituophis melanoleucus</i>	Short-grass prairie and desert grasslands
Plains Blackhead Snake	<i>Tantilla nigriceps</i>	Short-grass prairie and desert grasslands
Plains Spadefoot Toad	<i>Spea bombifrons</i>	Shallow to standing pools of water
Rattlesnakes	<i>Crotalus Sp.</i>	Short-grass prairie and desert grasslands
Sand Dune Lizard	<i>Sceloporus arenicolus</i>	Open sand and takes refuge under shinnery oak
Six-Lined racerunner	<i>Cnemidophorus sexlineatus</i>	Mixed-grass prairie and desert grasslands
Tiger Salamander	<i>Ambystoma tigrinum</i>	Tall-grass and mixed prairie
Texas Horned Lizard	<i>Phrynosoma cornutum</i>	Desert grasslands

Source: NRC, 2005

The Basin and Range Grassland occurs south of the Mescalero Ridge. These grasslands are higher in elevation and climatically cooler and moister than desert grasslands and are adjacent to and intermingle with juniper savanna ecosystems. The Great Basin Grasslands are similar to Brown's (1994) Plains and Great Basin grasslands and Dick-Peddie's (1993) Plains–Mesa grasslands except the geographic range of this category for this assessment is restricted to the Basin and Range Physiographic province. Diagnostic plant species include blue grama, galleta, Indian ricegrass, and sideoats grama. Some dropseeds and wolftail are co-dominant and add to the diversity of this category. The Great Basin grasslands tend to be drier than the Shortgrass Steppe grasslands and have a blend of warm and cool season graminoid and forb species. Shrubs that are present in association with grassland vegetation of this category include fourwing saltbush, sacahuista, small soapweed yucca, skunkbush sumac, and catcall mimosa. As this grassland integrates with savanna ecosystems, minor amounts of trees such as emory oak, alligator juniper, and Utah juniper dominated woodlands are evident (USDA, 2004). The IIFP site generally is characteristic of the Brown's (1994) vegetation.

Hairy grama is prevalent on the IIFP site and is a native, warm-season, perennial grass. The height is between 10 and 20 inches. The leaf blade is flat or slightly rolled; narrow; mostly basal; margins hairy. See Figure 3-33. This grass yields more if it is not overgrazed and grazing is deferred every 2 to 3 years during the period of most active growth. Hairy grama makes little growth before summer rains begin. If moisture is adequate, it matures rapidly.



Figure 3- 33 Hairy Grama Vegetation

During exceptionally dry years, it produces little forage but withstands drought well. In the northern part of its range, this grass usually has only 1 or 2 spikes per seedhead and short stolons that form a sod. Further south, it grows taller, more like a bunch grass, and has 2 to 4 spikes per seedhead. It is adapted to sandy and sandy loam soils and gravelly loams and does well on soils neutral to slightly calcareous. It is often associated with blue grama, but is more drought resistant (NRCS, 2007).

Ring Muhly (Figure 3-34) is also observed on the site with hairy grama and other various forbs and grasses. Mesquite, prickly pear, horse crippler cacti, and rainbow cacti were also observed. See Figure 3-35 for a typical site photograph of ground cover on the IIFP site.



Figure 3- 34 Ring Muhly Grass in Semi Desert Grasslands



Figure 3- 35 Site Photograph of Ground Cover on IIFP Site

3.5.4 Habitat Importance

The importance of the habitat for most threatened, endangered, and other important species relative to the habitat of those species throughout their entire range is rather low. Most of these species have little or no suitable habitat on the IIFP site and the habitats present on the site are not rare or uncommon in the local area or range wide for these species.

There is a low frequency and extent of shinnery oak dunes and large blowouts, which provide the habitat and micro-habitats necessary for sand dune lizard survival.

The IIFP site could provide suitable food sources for the lesser prairie chicken, though there are limited water sources on the site. Due to the high density of shrubs, the IIFP site is not optimal prairie dog habitat as well.

The vegetative community at the IIFP site can play an important role in providing suitable habitat for wildlife at the site and in the area with habitat conditions fluctuating with the relative abundance of individual plant species. Certain plant species that are better adapted to soil and climatic conditions of a given area occur at higher frequencies and define the vegetation community.

Shrubs provide habitat and seeds for bird and small mammal species. Perennial grasses provide forage for large grazing mammals and seeds for small mammals. The dominant plant species should be distributed uniformly across the site, such that no one area of the site contains that species exclusively. New Mexico Department of Game and Fish, U.S. Fish and Wildlife Service, and the New Mexico State Forestry Department personnel will be contacted for any threatened or endangered plant species on the IIFP site.

3.5.5 Listing of Rare, Threatened or Endangered (RTE) Species Known or Potentially Occurring in the Project Area

Based on information from New Mexico Department of Game and Fish, the U.S. Fish and Wildlife Service, the New Mexico Ecological Services Field Office, and the Bureau of Land Management-Carlsbad Field Office, the IIFP site is located within the known range of eight species of concern and four species on the endangered listing or candidate species. The lesser prairie chicken is currently on the federal candidate list for listing as a candidate species. The sand dune lizard is currently listed as a candidate species on the federal listing and as endangered on the New Mexico State Threatened and Endangered list. The northern aplomado falcon and the black-footed ferret are listed as endangered by the U.S. Fish and Wildlife Services. Additionally, the American peregrine falcon, the Arctic peregrine falcon, Baird's sparrow, and the Bell's vireo are listed as threatened by New Mexico. Eight species as shown in Table 3-11 are listed as a species of concern under the *Endangered Species Act* by the U.S. Fish and Wildlife Service (USFWS, 2009a).

Endangered species are any species which are in danger of extinction throughout all or a significant portion of its range. Threatened species are any species which are likely to become an endangered species within the foreseeable future throughout all or a significant portion of its range. For Lea County, the black-footed ferret and northern aplomado falcon are listed as endangered, while the lesser prairie chicken and the sand dune lizard are listed as candidate species.

3.5.6 Inter-specific Relationships Resulting in Decline of These RTE Species

In the late-1800s, large numbers of cattle were introduced onto Southwest grasslands occupied by aplomados, and their numbers remained high through the 1920s. Decades of overstocking had degraded desert grasslands by the 1920s. Recognition of this led to reductions in cattle numbers by the late-1920s and 1930s, particularly after passage of the *Taylor Grazing Act in 1934*. However, cattle stocking rates may have remained comparatively high well into the late-1900s, since these ranges were mostly in private ownership and not subject to regulation by the federal act (Texas Parks, 2009).

There is some evidence from early naturalists to support the notion that prairie dogs greatly expanded in the Southwest after the introduction of large cattle herds. Widespread and intensive grazing by cattle may have stimulated such an expansion, since prairie dogs require low-stature grassland habitats. Regardless of the cause, prairie dog numbers and acreages occupied were extremely high during the late-1800s through about 1920. A U.S. government campaign to control prairie dogs on publicly-owned lands in Arizona, New Mexico, and Texas by use of strychnine poison began in 1912. Prairie dogs were substantially reduced through poisoning by the 1920s. Their decline peaked in the 1930s, and they were virtually eliminated from southeastern Arizona and southwestern New Mexico by the 1940s and 1950s, respectively (Texas Parks, 2009).

Table 3- 11 Listed and Sensitive Species With Species of Concern in Lea County

Common Name	Scientific Name	Group	State Status	Federal Status ¹
Lesser Prairie Chicken	<i>Tympanuchus pallidicinctus</i>	Bird	Not Listed	Candidate
Sand Dune Lizard	<i>Sceloporus arenicolus</i>	Reptile	Endangered	Candidate
Northern Aplomado Falcon	<i>Falco femoralis septentrionalis</i>	Bird	Endangered	Endangered
Black-footed ferret	<i>Mustela nigripes</i>	Bird	Not Listed	Endangered
American Peregrine Falcon	<i>Falco peregrinus anatum</i>	Bird	Threatened	Species of concern
Arctic Peregrine Falcon	<i>Falco peregrinus tundrius</i>	Bird	Threatened	Species of concern
Baird's sparrow	<i>Ammodramus bairdii</i>	Bird	Threatened	Species of concern
Bell's Vireo	<i>Vireo bellii</i>	Bird	Threatened	Species of concern
Western Burrowing Owl	<i>Athene cunicularia hypugea</i>	Bird	Not Listed	Species of concern
Yellow-billed Cuckoo	<i>Coccyzus americanus</i>	Bird	Not Listed	Species of concern
Black-Tailed Prairie Dog	<i>Cynomys ludovicianus</i>	Mammal	Not Listed	Species of concern
Swift Fox	<i>Vulpes velox</i>	Mammal	Not Listed	Species of concern

¹**Endangered:** Any species which is in danger of extinction throughout all or a significant portion of its range.

Candidate: Candidate species (taxa for which the Service has sufficient information to propose that they be added to list of endangered and threatened species, but the listing action has been precluded by other higher priority listing activities.

Threatened: Any species which is likely to become an endangered species with the foreseeable future throughout all or a significant portion of its range.

Proposed: Any species of fish, wildlife or plant that is proposed in the Federal Register to be listed under section 4 of the Act. This could be either proposed for endangered or threatened status.

Species of Concern: Taxa for which further biological research and field study are needed to resolve their conservation status OR are considered sensitive, rare, or declining on lists maintained by Natural Heritage Programs, State wildlife agencies, other Federal agencies, or professional/academic scientific societies. Species of Concern are included for planning purposes only.

Source: USFWS, 2009a and NMGF, 2009

Prairie dogs once moved across the landscape over decades and centuries in response to drought, fire, bison grazing and other factors. Now prairie dog colonies are small and isolated with restricted movement and connectivity. It is reasoned that overall abundance, biomass, and catchability of avian and small mammal prey were greater inside prairie dog towns than in the surrounding grasslands. Many other sensitive species such as burrowing owls, mountain plovers, (non-listed) golden eagles, swift fox, and ferruginous hawks are strongly linked to this habitat for their survival. At least some potentially important avian prey species, such as meadowlarks, some plovers, mourning dove, horned lark, and others, seem to respond positively to grazing.

By continuously burrowing and clipping the plants around them (sometimes for food, other times to remove visual obstacles), prairie dogs create areas of unique habitat. The towns become sites of great wildlife diversity. Animals, including many small rodents, burrowing owls, and rattlesnakes make their homes in prairie dog burrows. As many as 140 different animal species have been identified on the towns, with varying degrees of dependency. At least one species, the endangered black-footed ferret, is largely dependent on the prairie dog for both its food and shelter.

The ferret populations suffered from prairie dog town fragmentation due to development and farming and diseases such as canine distemper and sylvatic plague. The prairie ecosystem was further transformed by

the poisoning, trapping and shooting of other prairie denizens such as badgers, coyotes, and foxes. These activities disrupted the natural processes of the ecosystem. Also, in the case of poisonings, often there can be secondary effects when non-target species consume a poisoned animal and subsequently die (BFFRIT, 2009).

The burrowing owl is directly dependent on prairie dog burrows and other prairie dog habitat features for optimal nesting and rearing of young. It appears that a majority of historic encounters with aplomado falcons and high numbers and acreage of black-tailed prairie dogs coincided with historically high livestock stocking rates on southwest grasslands (all between 1870 and 1920). One potential factor in the decline of the lesser prairie chickens is the near absence of prairie dog towns throughout much of its historic range (BFFRIT, 2009).

3.5.7 Description of RTE Species Known or Potentially Occurring in the Project Area

Specific information, as habitat requirements, life history, and population dynamics on each RTE specie listed in Table 3-12, is provided below.

3.5.7.1 Lesser Prairie Chicken

A member of the grouse family, the adult lesser prairie chicken (See Figure 3-36.) is 38-41 cm (15-16 in) tall, a smaller and paler version of the greater prairie chicken. The male has reddish colored air sacs on the neck that are inflated and deflated to create a "booming" sound during courtship. The lesser prairie chicken diet consists of insects and seeds of wild plants and grains such as sorghum, oats and wheat when available. During periods of below average precipitation, water distribution can become a limiting factor for lesser prairie-chicken habitat in southeastern New Mexico. The IIFP site could provide suitable food sources for the lesser prairie chicken, though there are limited water sources on the site.



Figure 3- 36 The Lesser Prairie Chicken

Habitat Requirements

The lesser prairie chicken requires relatively large areas of native prairie mixed shrub lands for cover, food, water and breeding. Ideal interspersions of lesser prairie-chicken habitat components consists of a complex of sand sagebrush, sand plum, skunkbush sumac, and shinnery oak shrubs and sand dropseed, side oats grama, sand bluestem, and little bluestem grasses growing in various stages of development on open rangelands with flat surfaces. In order for successful lesser prairie-chicken reproduction and survival to occur, all required habitat components must be available in relatively close proximity to one another

(within 2-4 mi²). For example, the highest-quality nesting habitat is of little use if the nearest open foraging habitat is not close by. Distribution and interspersions of food and cover in the form of varying habitats determines whether or not an area can support a lesser prairie-chicken population and the number of individuals in a population (NRCS, 1999).

The minimum land area needed to maintain a breeding population of lesser prairie chickens is an area of prime nesting and brood-rearing cover approximately two-square miles (1,280 acres) in size, surrounded by a minimum of 10,000 acres of feeding and loafing habitat. Complexes of suitable lesser prairie chicken habitat of up to 25,000 acres provide optimum conditions for maintaining populations. While smaller parcels by themselves may not provide the area needed, each contributes to the mosaic of larger habitat blocks that do meet minimum habitat size requirements. Although typically not a limiting factor on rangelands due to cattle grazing patterns, lek areas created through active habitat management efforts should be at least 50 yards in diameter per 15 males and located on higher ground with little or no shrub cover (NRCS, 1999).

Lesser prairie chickens prefer to use the same gobbling grounds or leks each year, but often move their leks to another site if the vegetation structure is inadequate. Short vegetation is preferred on gobbling grounds, so mowing, spot burning followed by spot grazing, or supplementing cattle on the gobbling ground will usually improve its attractiveness to lesser prairie chickens. Prairie dog towns are favorite places for gobbling grounds. Less than 1% of historic prairie dog towns remain. Besides creating optimal gobbling ground conditions, prairie dog towns play an important role in creating lesser prairie-chicken habitat. Many important forbs that produce seed are common around prairie dog towns and are particularly evident after abandonment. These highly disturbed areas create diverse early succession and plant communities (i.e., abundant annual and perennial forbs) that are very important for lesser prairie-chicken adults and broods. For these reasons, rangeland and wildlife professionals have raised serious questions about traditional management philosophies that endorse prairie dog eradication, herbicide use, and uniform grazing patterns (OSU, 2002).

In the area of the IIFP site, the presence of mesquite shrubs provide needed protective cover from raptors and the short grass prairie vegetation meets the requirements for the breeding areas known as "booming grounds" or leks. Though the IIFP site contains suitable lesser prairie chicken habitat, this type of habitat is not uncommon in the general area.

A nomination has been submitted (Stinnett, 2002) to the Bureau of Land Management (BLM) to designate two public land parcels within Lea County as an Area of Critical Environmental Concern (ACEC) for the lesser prairie chicken. The nearest nominated ACEC straddles Lea and Eddy Counties and is about 24 km (15 mi) west of the proposed IIFP site. The other nominated ACEC, which is further north, borders the northwest corner of Lea County. Currently, the BLM is evaluating this nomination and expects to make a decision within the next several years. See Figure 3-37 for the map showing the historic and current distribution of the lesser prairie chicken (WildEarth Guardians, 2008).

Life History

Normal clutch size is 11 to 14 eggs. The eggs are grayish-olive, buffy-plain, or spotted (rarely). Nests are slight excavations in well-drained soils and are lined with grasses and feathers. The incubation period ranges from 23 to 28 days, but typically lasts 25 days. The hen will lead her brood away from the nest within hours after the last chick has hatched, usually in early morning. Hens then move broods into areas of early stage plant succession. Such areas have abundant tall forbs, an open understory with bare ground, and high insect densities. The brood usually remains with the hen 8 to 10 weeks, after which the brood

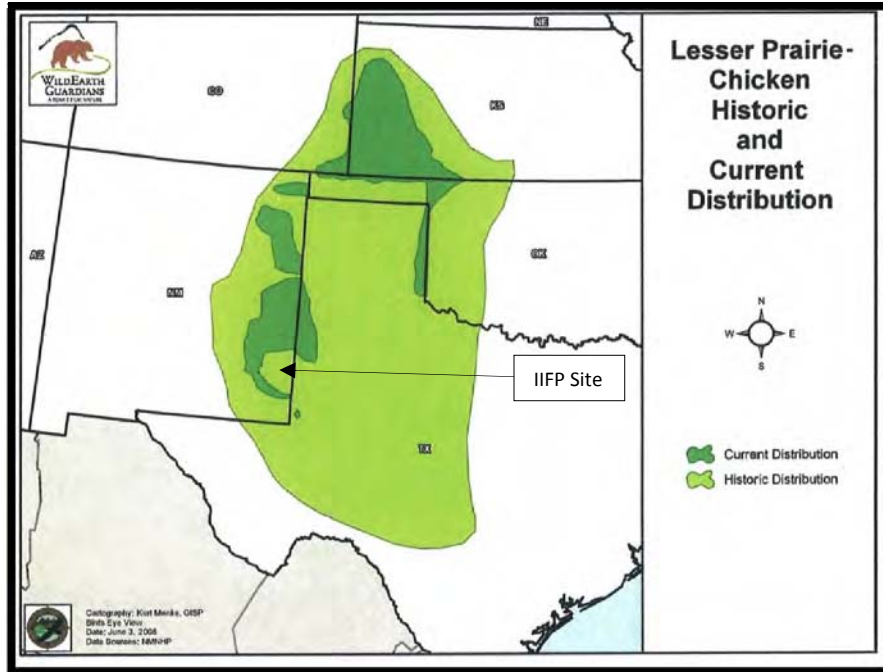

Source: WildEarth Guardians, 2008

Figure 3- 37 Lesser Prairie Chicken Historic and Current Distribution

disperses. Often, two or more broods will intermix when 6 to 8 weeks old. Juveniles will attend established leks in the fall, triggered by changing day length (OSU, 2002).

Population Dynamics

The life cycles of prairie-chickens require vast areas of relatively unfragmented grassland habitat. More than 90% of North America’s historic prairies have been destroyed or seriously altered. Thus, the effect of each additional fragmentation influence is magnified. Many other factors diminish existing unfragmented habitats, including oil and gas production, road construction, housing development, crop production, excessive livestock grazing, and woody plant invasion. Lesser prairie chickens avoid even high-quality habitat within 200 m (656 ft) of a single oil or gas well pump, and they avoid the area within 600 m (1,970 ft) of an improved road, and within 1,000 m (3,280 ft) of an elevated power line, regardless of whether avian predators are present (OSU, 2002). High human disturbance and predator potential in the area make it unlikely that lesser prairie chickens will colonize the area. Based on these findings, no mitigation measures are planned to reduce the impacts on or to protect the lesser prairie chicken at the IIFP site.

3.5.7.2 Sand Dune Lizard

A small diurnal species of *Sceloporus*, the sand dune lizard has a maximum snout to vent length of 70 mm (2.8 in) in females and 65 mm (2.6 in) in males (CBD, 2002). Its upper surface is light brown without distinct pattern. A grayish-brown band extends from the ear onto the tail. On some individuals, the chin and throat has scattered blue flecking. Dorsal scales are keeled and pointed. See Figure 3-38.



Source: CBD, 2002

Figure 3- 38 Female Sand Dune Lizard Under Shinnery Oak

Habitat Requirements

The sand dune lizard populations are mostly confined to shinnery oaks and dune habitats of southeastern New Mexico and West Texas. This lizard occurs only in areas with open sand, but forages and takes refuge under shinnery oak and is seldom more than 4 to 6 ft from the nearest plant. The sand dune lizard is restricted to areas where sand dune blow-outs, topographic relief, or shinnery oak occur. See Figure 3-39, “Sand Blowout Surrounded by Shinnery Oak, Exemplifying Optimal Sand Dune Lizard Habitat.”



Figure 3- 39 Sand Blowout Surrounded by Shinnery Oak, Exemplifying Optimal Sand Dune Lizard Habitat

Sand dune lizards do not use dunes that lack shinnery oak, which they probably use for cover from predators, foraging, and shade. Sand dune lizards select sites with more medium sand grains (>250-354 μm) and less coarse, fine and extra fine grains, though the reasons for this are not yet fully understood. One possibility is that fine-grained sand inhibits respiration when sand dune lizards bury themselves to avoid predators or to regulate their temperature. Because the sand dune lizard is dependent on a feature of the landscape—dune blowouts—that is spatially dynamic, protection of habitat presents a difficult problem. As wind blows sand across the landscape, areas that are suitable today may not be in the future and areas that are unsuitable may become so in the future (CBD, 2002).

Dunes that have become completely stable by vegetation appear to be unsuitable habitat. The sand dune lizard diet consists primarily of insects such as ants, crickets, grasshoppers, beetles, spiders, ticks and other arthropods. Most feeding appears to take place with or immediately adjacent to patches of vegetation. It is likely that the IIFP site provides an adequate food source for the sand dune lizard; however, the habitat areas likely containing the sand dune lizard starts approximated 19.3 km (12 mi) south of the IIFP site. See Figure 3-40, “Expected Range of the Sand Dune Lizard,” in Lea, Eddy, and Chaves Counties, New Mexico (Painter, 2004).

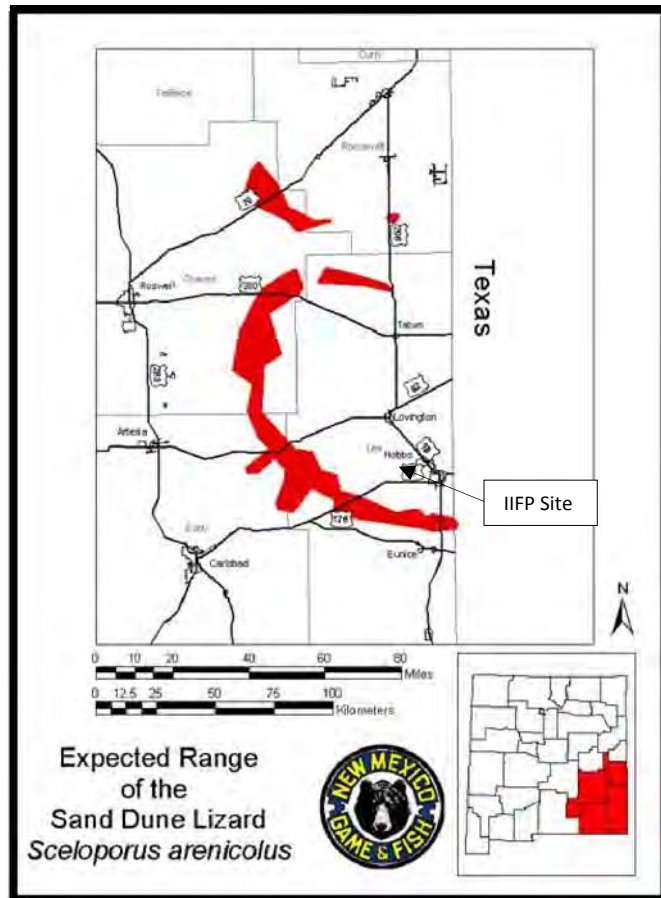

Source: NMGF, 2004, Painter, 2004

Figure 3- 40 Expected Range of the Sand Dune Lizard

Life History

Females reach sexual maturity in their first spring after hatching with vitellogenesis beginning in late April. Some individuals live and reproduce for two years. Females can produce 1-2 clutches with 3-6 eggs per clutch. The first clutch is laid in late June and the second in late July. Hatching occurs between late July and late September. Juvenile and adult survival has not been calculated for the sand dune lizard, but it is known that some individuals live and reproduce for two years (CBD, 2002).

Population Dynamics

The sand dune lizard has a limited and often spotty distribution throughout its range in southeastern New Mexico. Estimated population densities are low: e.g. only 3 to 4.9 lizards/acre in good habitat east of Roswell and Chaves Counties, New Mexico (Painter, 2004). The sand dune lizard is endemic to a small area of shinnery oak habitat in parts of southeast New Mexico and adjacent Texas. In New Mexico, the species is known to exist as fragmented populations within an area of approximately 2,312 sq. km (892.6 sq. mi) in parts of Chaves, Eddy, Lea, and Roosevelt counties. However, within this area the potential and occupied habitat consists of only 1,697.3 sq. km (655.3 sq. mi). Total extent of the range in Texas is unknown although it includes parts of Andrews, Crane, Gaines, Ward, and Winkler counties. In New Mexico, large populations of the sand dune lizard occur on lands managed by the U.S. Department of Interior Bureau of Land Management (BLM) (48.9%) although important populations occur on New Mexico State (20.1%) and private lands (30.9%) as well. Historic population sizes of the sand dune lizard are unknown, although the chemical treatment and removal of shinnery oak and oil and gas extraction activities have caused the decrease or extirpation of some populations since the species were discovered in southeast New Mexico in 1960 (CBD, 2002).

The high frequency of mesquite and grassland associations on the site is associated with environmental conditions that do not support the specie. In addition, the frequency and extent of shinoak dunes and large blowouts on the site, which provide the habitat and microhabitats necessary for sand dune lizards' survival, are low. No mitigation measures are planned at this time to reduce impacts on or protect the sand dune lizard at the IIFP site.

3.5.7.3 Northern Aplomado Falcon

Historically, northern aplomado falcons were found throughout coastal prairie habitat along the southern Gulf coast of Texas, and in savanna and grassland habitat along both sides of the Texas-Mexico border, southern New Mexico, and southeastern Arizona. The aplomado falcon has a steel grey back, red breast, black "sash" on its belly, and striking black markings on the top of its head, around its eyes, and extending down its face. See Figure 3-41 for a photograph of the northern aplomado falcon.



Figure 3- 41 Photograph of the Northern Aplomado Falcon

Habitat Requirements

The aplomado falcon requires open habitats that have scattered trees for hunting, roosting, and nesting and an understory of grass and shrubs. Habitat types include yucca-covered ridges in coastal prairie, riparian woodland in open grassland, palm and oak savannas, deciduous woodland, yucca-mesquite grasslands, and a variety of other open desert grassland and shrub habitats. The aplomado falcons do not build their own nests; instead they use abandoned stick nests of other bird species, including other raptor species, crows, and ravens (USFWS, 2005).

Life History

Aplomado falcons are most often seen in pairs. Pairs work together to find prey and flush it from cover. Aplomados eat most birds and insects. They are fast fliers and often chase prey animals as they try to escape into dense grass. Parents make 25-30 hunting attempts per day in order to feed their young. Chicks are fed 6 or more times each day. They live up to 20 years in captivity (USFWS, 2005).

Population Dynamics

Historic ranges of the black-tailed prairie dog and the northern aplomado falcon in the Southwest matched closely. This has led to speculation that habitat conditions generated by prairie dogs may have benefited aplomado falcons. Insects, reptiles, birds, and small mammals that used prairie dog colonies were probably easier to detect and catch by aplomados than in surrounding grasslands, where herbaceous vegetation was denser and higher. In similar ways, cattle grazing may have provided short-term benefits to aplomados (Texas Parks, 2009).

The natural coincidence of aplomado and prairie dog distributions in the Southwest and their simultaneous declines suggest that these events may have been related. Prairie dogs were eradicated by strychnine poisoning. This method of control was nonselective and undoubtedly killed other wildlife in the vicinity of dog towns. Aplomado falcons could have been adversely affected by feeding on poisoned birds and mammals through relay toxicity. Relay toxicity also could have killed other raptors and ravens that provided nest platforms for aplomados (Texas Parks, 2009).

Aplomado falcons and black-tailed prairie dogs, with overlapping distributions, disappeared from the Southwest landscape in the 1930s. Although, it is clear that prairie dogs were intentionally eradicated, causes of the aplomados disappearance remain obscure. In Arizona and New Mexico, large scale mesquite and other shrub invasion into grasslands appears to have occurred after the demise of the falcon (Texas Parks, 2009).

In 1986, the northern aplomado falcon was federally listed as endangered in the U.S. and in Mexico based on evidence of population declines in the U.S. and threats to reproduction in eastern Mexico related to pesticide contamination. Subsequently, the northern subspecies was state-listed as endangered in Arizona, New Mexico, and Texas; and in 1990, a federal recovery plan was prepared. No mitigation measures are planned at this time to reduce impacts on or protect the northern aplomado falcon at the IIFP site.

3.5.7.4 Black-Footed Ferret

It is a slender, wiry animal with a black face mask, black feet, and a black-tipped tail. The rest of its short, sleek fur is a yellow-buff color, lighter on the belly and nearly white on the forehead, muzzle, and throat. See Figure 3-42 for a photograph of the black-footed ferret. It has short legs with large front paws and



Figure 3- 42 Black-Footed Ferret in a Snow Environment

claws developed for digging. The ferret's large ears and eyes suggest it has acute hearing and sight, but smell is probably its most important sense for hunting prey underground in the dark.

Habitat Requirements

The black-footed ferret is well adapted to its prairie environment. Its color and marking blend so well with grassland soils and plants that it is hard to detect until it moves. Conversion of native grasslands to intensive agricultural uses, widespread prairie dog eradication programs, and the fatal non-native plague disease have reduced ferret habitat to less than 2% of what once existed. Remaining habitat is now fragmented, with prairie dog towns separated by expanses of cropland and human development. They spend most of their time underground in prairie dog burrows, typically spending only a few minutes above ground each day to hunt or find new burrows or, in spring, to mate. In burrows they sleep, cache their food, escape from predators and harsh weather, and give birth to their young. Ferrets do not hibernate, but in winter, the amount of time they are active and the distances they travel decrease substantially. They have been found to remain underground in the same burrow system for a week at a time in winter (BFFRIT, 2009).

Life History

The black-footed ferret is 46 to 61 cm (18 to 24 in) long, including a 13 to 15 cm (5 to 6 in) tail. It weighs only 0.7 to 1.1 kg (1.5 to 2.5 lb), with males slightly larger than females. Breeding activity generally occurs in March and April, and after a gestation period of 41 to 43 days, a litter of kits is born. The average litter size is three to four young, but single kits, as well as litters of nine or ten have been recorded (BFFRIT, 2009).

Population

Black-footed ferrets once occurred in grassland habitats throughout the Great Plains in 12 states and two Canadian provinces, and likely portions of northern Mexico. In the decades following their discovery, European settlement across North America changed the landscape rapidly and dramatically. Through the plowing of the land and poisoning of prairie dogs, the habitat was transformed into largely exclusive crop and grazing land respectively. As their habitat and primary food and shelter source diminished, so did the black-footed ferret. Today, less than 2% of the original geographic distribution remains (BFFRIT, 2009).

In the 1950s, ferrets were still thought to occur in low densities throughout most of their historic range. No mitigation measures are planned at this time to reduce impacts on or protect the black-footed ferret at the IIFP site.

3.5.7.5 American Peregrine Falcon

The peregrine is the fastest bird (See Figure 3-43) on record reaching horizontal cruising speeds of 65-90 km/h (40-55 mph) and not exceeding speeds of 105-110 km/h (65-68 mph). When in a stooping position, the peregrine flies at much greater speeds, varying from 160-440 km/h (99-273 mph) (Extreme Science, 2008).



Figure 3- 43 American Peregrine Falcon

Habitat Requirements

In the Rocky Mountain States, peregrine falcons require cliffs for breeding, and there are no cliffs in the area. The nest is a scrape or depression dug in gravel on a cliff ledge. Rarely, peregrines will nest in a tree cavity or an old stick nest. Many peregrines readily nest on manmade structures, including skyscraper ledges, tall towers, and bridges, the urban equivalents of cliff ledges (USFWS, 2006).

Life History

Peregrine falcons are monogamous. They also breed in the same territory or area for their entire lives. There are exceptions, such as when one mate dies or is replaced by a stronger individual. Sexual maturity occurs during the second year of life, followed by approximately one month of courtship. In the spring, 3 or 4 eggs are laid. Incubation takes approximately 33 days and although both parents share incubating duties, the female performs the greater share. Two or three chicks usually hatch and fledge in approximately 42 days. After fledging, young peregrine falcons are still dependent on their parents for food until they learn to hunt which takes about 1-1/2 months (USFWS, 2008).

Population Dynamics

Studies in the 1930s and 1940s estimated that there were about 500 breeding pairs of peregrine falcons in the eastern United States and about 1,000 pairs in the West and Mexico. Then, beginning in the late

1940s, peregrine falcons suffered a devastating and rapid decline. By the mid-1960s, the species had been eliminated from nearly all of the eastern U.S. Although less severe, the decline spread west, where peregrine populations were reduced by 80 to 90% by the mid-1970s.

The proposed IIFP site has little to no potential to attract breeding American peregrine falcons. The species uses a variety of open habitats, potentially like those on the IIFP site, for foraging, but the closest breeding sites make it unlikely that birds would travel to the area for foraging. Transient birds may use the area during migration but the species are unlikely to winter in the area.

3.5.7.6 Arctic Peregrine Falcon

The Arctic peregrine falcon is very similar to the American peregrine falcon except that it is slightly smaller and paler (FWS, 2001)

Habitat Requirements

The arctic peregrine falcon (Figure 3-44) breeds on the North American tundra and winters along the Gulf Coast from Florida west to eastern Mexico. It is also found in winter in Baja California and south to Chile and Argentina.



Source: FWS, 2001

Figure 3- 44 Arctic Peregrine Falcon

Life History

The life history characteristics of the Arctic peregrine falcon are the same as the American peregrine falcon subspecies.

Population Dynamics

The Arctic peregrine falcon breeds on the North American tundra and winters along the Gulf Coast from Florida west to eastern Mexico. It is also found in winter in Baja California and south to Chile and Argentina (FWS, 2001).

Today, Arctic peregrine numbers continue to increase. Although the species is currently doing well, there are still threats, such as habitat modification that could potentially affect Arctic peregrines. Since habitat

modification has drastically increased since the 1970s, however, while Arctic peregrine populations tripled during the same period, habitat modification may not currently threaten the continued existence of the subspecies. Pesticides accumulated in Latin America, where the use of DDT continues, still affect eggshell thickness, and although shell thickness has increased, it is still below pre-DDT levels and therefore still at risk of decreasing to below critical levels (CBD, 2009).

The proposed IIFP site has little to no potential to attract breeding arctic peregrine falcons. Arctic peregrine falcons are not known to breed in New Mexico. Transient birds may use the area during migration but they are unlikely to winter in the area.

3.5.7.7 Baird's Sparrow

The Baird's Sparrow has an ochre-colored median crown stripe, narrow band of fine black streaks on a light-colored breast with yellowish-brown head, brownish-streaked body. (See Figure 3-45.)



Figure 3- 45 Baird's Sparrow

Habitat Requirements

Details of winter habitat requirements of Baird's sparrow are not well understood. Generally, the species winters in areas of dense and expansive grasslands, with only a minor shrub component. In Arizona, Baird's sparrows winter in diverse desert grasslands dominated by perennial bunchgrasses, including many species of grama, three-awn and lovegrass, both native and exotic. In these areas, scattered mesquite is the only significant woody vegetation. In various studies, Baird's sparrows established territories in grasslands dominated by native grasses, shrub cover <20%, litter depth 0.1 to 4 cm, and average grass height 10 to 30 cm (4 to 12 in) (NMACP, 2009).

Areas with fairly extensive litter and ground cover, but lacking a solid mat of vegetation, are preferred. In Arizona, higher abundances were recorded in summer-grazed pasture than in a nearby area ungrazed for 30 years. However, this species elsewhere shows a preference for minimally grazed areas, and may be absent from areas receiving more than a moderate amount of grazing. In southern New Mexico, Baird's sparrows prefer areas with denser grass cover than surrounding areas. Baird's sparrows typically arrive in the Southwest from September to mid-October, and remain through early April (NMACP, 2009).

Life History

Facts for the life history of the Baird's sparrow (USFWS, 2009b) are as follows:

- Only female chooses nest site and incubates eggs although both parents tend to young.
- Prefers mixed grass native prairie and forbs without excessive grass litter or heavy brush.
- Three to six eggs in nest with an average of five. Eggs grayish-white and heavily marked with reddish-brown spots.
- Incubation period of 11 to 12 days.
- Nestlings spend eight to 10 days in the nest and depart with the parents while still flightless.
- Feeds mainly on insects and seeds.
- Young eat only spiders and insects.
- One brood per year.

Population Dynamics

Baird's Sparrow breeds in a fairly small geographic area of south-central Canada, Montana, and North and South Dakota. It winters on grasslands of the northern Mexican plateau, primarily in Chihuahua and Durango but including portions of bordering states. The winter range extends into small portions of southeast Arizona, southern New Mexico, and southwest Texas. In New Mexico, Baird's sparrow has been found on Otero Mesa and in the Animas Valley, and may occur in other areas of suitable winter habitat, particularly in the southeast portion of state. Areas with fairly extensive litter and ground cover, but lacking a solid amt of vegetation, are preferred. In Southern New Mexico, Baird's sparrows prefer areas with denser grass cover than surrounding areas. Baird's sparrows typically arrive in the Southwest from September to mid-October, and remain through early April (NMACP, 2009).

Baird's sparrow populations have been reduced by conversion of native prairie breeding habitat to cropland and exotic vegetation, invasion of native grasslands by exotic plant species, and proliferation of shrubs due to fire suppression. It is not known to what degree these same factors in wintering areas contribute to population declines. In New Mexico, wintering Baird's sparrows are considered vulnerable to ongoing fragmentation and degradation of Chihuahuan desert grassland habitat. It is estimated a species population of 1.2 million. Size of the wintering population in New Mexico is unknown, but considered small and somewhat variable (NMACP, 2009).

The proposed IIFP site is outside of the breeding range of the Baird's sparrow and does not include typical breeding habitat. Baird's sparrows may utilize the area during migration, but the species is not likely to winter in the area. In winter, Baird's sparrows prefer dense grassy habitats and are generally found to the south of the IIFP site.

3.5.7.8 Bell's Vireo

A small insectivorous bird of the central and southwestern United States and northern Mexico, the Bell's Vireo is drably colored and indistinctly marked. It is best told from other vireos by its facial pattern. The white eye ring of the Bell's Vireo is broken in front of and behind the eye. See Figure 3-46. Its distinctive song can be heard coming from the dense vegetation of scrubby woodlands, old fields, or mesquite brushlands.



Source: USGS, 2009b

Figure 3- 46 Bell's Vireo

Habitat Requirements

This species prefers to nest in low, dense, scrubby vegetation in areas of early succession and is particularly dependent on corridors of habitat along rivers and streams. A variety of trees are used, including willow (especially arroyo, black, and seep willows), cottonwood, coastal live oak, and mesquite. Research on the endangered Least Bell's Vireo suggests that it is most important to have a dense shrub layer between 0.6 and 3.0 m (2 and 10 ft) from the ground. It occurs from sea level to about 1,219 m (4,000 ft). Migrating vireos use thick scrub, coastal chaparral, and brushy fields. In winter, they inhabit similar ecosystems in Mexico (NAS, 2007).

Life History

Interesting facts on the life history of the Bell's vireos (USGS, 2009) are as follows:

- Breeding Habitat: Successional-Scrub
- Nest Location: Ground-low nesting; Nest Type: Open-cup
- Clutch Size: 3-5
- Length of Incubation: 14 days
- Days to Fledge: 11-12
- Number of Broods: 2
- Diet: Almost Exclusively Insects

Population Dynamics

The breeding range of this species extends, in the Midwest, from North Dakota to Indiana, south through Arkansas. It breeds across much of Texas westward through southern New Mexico and Arizona into southern California. Breeding bird survey data between 1994 and 2003 show the greatest concentrations in south central Arizona, southwestern Texas, and east central Oklahoma (NAS, 2007).

The Bell's Vireo is a neotropical migrant. In late summer and early fall, birds in the northern part of its range begin moving south, but the migration is drawn out, with many lingering in southern California and southwestern Arizona through November. Singing along the way, males depart their wintering grounds in

Mexico sometime in early spring, so that early arrivals appear in the southern U.S. in March. Females soon follow, and both sexes appear to migrate mostly at night in loose flocks (NAS, 2007).

The proposed IIFP site is unlikely to attract Bell's vireos. In New Mexico, the species generally uses dense riparian woodland habitats for breeding. Although dense mesquite thickets may be used by the species, they generally will use areas only near water. Transient birds may use the area during migration, but they are very unlikely to winter in the area.

3.5.7.9 Western Burrowing Owl

Burrowing owls have bright yellow eyes. The beak can be between yellowish or greenish depending on the subspecies. The owls have prominent white eyebrows and a white "chin" patch which they expand and display during certain behaviors, such as bobbing of the head when agitated.

Adult owls have very brown upperparts with white spotting. The breast and belly are white with variable brown spotting or barring (See Figure 3-47). Males and females are similar in size and appearance. The female bird is darker in color, however, adult males appear lighter in color because they spend more time outside the burrow during daylight, and their feathers become "sun-bleached." The average adult is slightly larger than an American robin at 25 cm (10 in) length, 53 cm (21 in) wingspan, and 170g (6 oz) (Wikipedia, 2009).



Figure 3- 47 Burrowing Owl

Habitat Requirements

Their typical breeding habitat is open grassland or prairie. Burrowing owls are slightly tolerant of human presence, often nesting near roads, farms, homes, and regularly maintained irrigation canals. The owls nest in an underground burrow. If burrows are unavailable and the soil is not hard or rocky, the owls may excavate their own. Burrowing owls will also nest in shallow, underground, man-made structures that have easy access to the surface.

Life History

The nesting season begins in late March or April in North America. Burrowing owls are usually monogamous, but occasionally a male will have two mates. Pairs of owls will sometimes nest in loose colonies. The female will lay an egg every 1 or 2 days until she has completed a clutch, which can consist of 4-12 eggs (usually 9). She will then incubate the eggs for three to four weeks while the male brings her

food. After the eggs hatch, both parents will feed the chicks. Four weeks after hatching, the chicks are able to make short flights and begin leaving the nest burrow. The parents will still help feed the chicks for 1 to 3 months. While most of the eggs will hatch, only four to five chicks usually survive to leave the nest (Wikipedia, 2009).

Population Dynamics

Data for Western Burrowing Owls in most of the U.S. are insufficient to estimate trends in abundance. Limited data suggest that they are decreasing in some areas, but may be stable or increasing in others. Populations in New Mexico have exhibited mixed trends. Stable or increasing populations were associated with the presence of suitable habitat and increased precipitation and food availability, while decreasing populations were associated with loss of suitable habitat. They migrate south during September and October, and north during March and April. In many parts of their range they are non-migratory (FWS, 2003).

The proposed IIFP site has the potential to attract burrowing owls. The site is within the range of burrowing owls and harbors habitats (open grass and shrub habitats with sparse cover) used by burrowing owls. The species requires burrows (natural or human-constructed) for nesting. If there are burrowing mammals such as prairie dogs or badgers in the area, then it is likely that the area may be attractive to burrowing owls.

3.5.7.10 Yellow-Billed Cuckoo

Yellow-billed cuckoos reach a length of 26 to 32 cm (10.5 to 12.5 in), with a wingspan of 43 cm (17 in). Their lower bill is yellow, and they have a black upper bill that curves slightly downward. Head, neck, back and upper wings are brown, with a white chin, breast and belly. See Figure 3-48 for a picture of the yellow-billed cuckoo. They also have two columns of large white spots on the underside of their long, slender tail. Feathers account for almost half of the yellow-billed cuckoo's body weight (Texas Parks, 2009b).



Manomet, 2009

Figure 3- 48 Yellow-Billed Cuckoo

Habitat Requirements

Open woodlands with dense undergrowth, overgrown orchards and pastures, moist thickets and willow groves along stream banks are the preferred habitat of the yellow-billed cuckoo.

Life History

The varied diet of the yellow-billed cuckoo includes insects (especially hairy caterpillars and cicadas) bird eggs, snails, small frogs, lizards, berries, and some fruit. Predators such as raccoons and jays feed on the cuckoo's eggs, and fledglings are sometimes eaten by raptors. Yellow-billed cuckoos reach sexual maturity in the spring. Mating season lasts from mid-April through mid-September, peaking in May. Nests are saucer-shaped and flimsy, made of twigs and lined with roots and dried leaves, 1 to 2.5 m (4 to 8 ft) above the ground. Females typically lay two to four light blue eggs, about 31mm (1.2 in) long. Chicks hatch in nine to 11 days. The chicks are altricial (they hatch helpless, blind, and featherless). Within a week of hatching, the chicks can climb onto branches and within three weeks, they can fly (Texas Parks, 2009b).

Because they spend winters in mature tropical forests in South America, they are one of the last migratory bird species to arrive in North America. They arrive so late that they have little time to build a nest, select a mate, lay eggs and raise their young. Cuckoos mate with one partner a year. The male courts the female by offering her sticks and other nest building materials. If the female seems receptive, the male will land on her shoulders and place a piece of food in her mouth. Egg laying is timed to occur when caterpillars and other invertebrate prey are most abundant. If food is abundant, the cuckoos will lay more eggs, and they will sometimes use other birds' nests (nest parasitism). The male takes care of the first fledgling and the female cares for the rest (Texas Parks, 2009b).

Population Dynamics

Yellow-billed cuckoos range throughout North, Central and South America. They migrate to North America throughout the summer months, but winter in South America. They can be seen in Texas from April through November (Texas Parks, 2009b).

The proposed IIFP site has little to no potential to attract breeding yellow-billed cuckoos. Cuckoos require riparian woodlands and, in the Southwest, are generally not found using other habitats. Dense underground foliage appears to be an important factor in nest site selection, while riparian willow and cottonwood trees are an important foraging habit. There are no areas on the IIFP site that would qualify as riparian woodland suitable for breeding yellow-billed cuckoos. It is possible that a cuckoo might use the site during migration, but wintering at the site would be very unlikely.

3.5.7.11 Black-Tailed Prairie Dog

Black-tailed prairie dogs are large rodents weighing 0.5 to 1.4 kg (1 to 3 lb) and are 25 to 41 cm (10 to 16 in) long. See Figure 3-49. They live in well-organized colonies or "towns" with family subgroups. Prairie dogs dig extensive, deep and permanent burrows with a dome-shaped mound at the entrance. Nest cavities are in the deeper parts of burrows for protection of the young and to mitigate temperature fluctuations. Black-tailed prairie dogs are diurnal, being active primarily during daylight hours. In southeastern New Mexico, they may remain active throughout the year, although they may remain below ground during adverse winter weather (NRCS, 2003).



Texas Parks, 2009a

Figure 3- 49 Black-Tailed Prairie Dogs

Habitat Requirements

Throughout much of its range, black-tailed prairie dog habitat consists of short grass plains, mid-grass prairies, and grass-shrub habitats. Historically, they were widespread and abundant east of the Rio Grande River and in the grasslands of southwestern New Mexico. Though they have expanded their range into shinnery oak and other grass-shrub habitats, they typically avoid areas with tall grass, heavy sagebrush, and other thick vegetation cover. Colonies of black-tailed prairie dogs have been reported in the Plains-Mesa Grasslands vegetation type of southeastern New Mexico. They are not dependent on free water, getting adequate water from plants and precipitation events in arid and semi-arid habitats (NRCS, 2003).

Black-tailed prairie dogs depend on grass as their dominant food source, and usually establish colonies in short-grass vegetation types that allow them to see and escape predators. Tall grass and shrubs provide hiding cover for predators such as coyotes and badgers. Shrubs provide perching locations for raptors that also prey on prairie dogs (NRCS, 2003).

Life History

Historically, black-tailed prairie dog towns on the mixed grass plains ranged in size from a few individuals to several thousand. Currently, large concentrations are rare due to extensive poisoning and loss of habitat during the last century. Typically, in southeastern New Mexico, prairie dog towns range in size from 20 to 100 acres, although some towns are smaller than 20 acres and some are larger than 100 acres (NRCS, 2003).

Population Dynamics

Black-tailed prairie dogs breed from January to March, with a 29-60 day gestation period. Young are live-born with litter size ranging from 3 to 5. Normally, there is one litter per year. At about six weeks of age, the young appear above ground and are able to walk, run, and eat green food. The family units remain intact for almost another month, but the ties are gradually broken and the family disperses. Sexual maturity is reached in the second year (NRCS, 2003).

Formerly, the chief predators of black-tailed prairie dogs were black-footed ferrets, badgers, and raptors. Because of their competition with domestic livestock for grass, prairie dogs were extensively poisoned, trapped, and hunted during the late 19th century and throughout the 20th century. Consequently, the

prairie dog numbers have been reduced by 98% to 99% of their former numbers across the West (NRCS, 2003).

No mitigation measures are planned to reduce the impacts on or to protect the black-tailed prairie dog at the IIFP site.

3.5.7.12 Swift Fox

Swift foxes have buffy-gray backs, orange-tan sides, whitish throats, chests, and bellies, black-tipped, bushy tails, and black patches on either side of their noses. In the winter, their fur becomes thick and soft (Figure 3-50). Adult swift foxes weigh less than six pounds and body length seldom exceeds 34 inches. Swift foxes are monogamous and pair for life. They are primarily nocturnal and use dens year-round, unlike other members of the canid family (NRCS, 2005).



NRCS, 2005

Figure 3- 50 Swift Fox

Habitat Requirements

Swift foxes typically prefer short-grass or mixed-grass prairie with flat to gently rolling terrain and low-growing sparse vegetation that allows for good mobility and visibility. Habitats within the short-grass and mixed-grass prairie ecosystems are able to provide the essentials for swift fox survival. These essentials include a diverse prey base, topography that allows long viewing distances to detect predators, and firm, friable soils suitable for dens. Swift foxes tend to avoid areas of dense shrubs and tall vegetation, which, because of their small size, limit their vision and movements (NRCS, 2005).

Life History

Swift foxes begin their breeding season in late December or early January in the southern portion of their range, and as late as March in the northern portion of their range. Gestation is approximately 51 days, and litter sizes range from one to seven pups, born in early spring. Pups live in the pup-rearing den until late May/early June, after which they frequent temporary dens in the immediate vicinity, but return to the pup-rearing den every 4 to 5 days. Young foxes typically disperse in autumn, when they are 4 to 6 months old (NRCS, 2005).

The average adult swift fox frequents a core area of approximately 544 acres (0.85 mi²). During breeding season or when food resources are scarce, swift foxes travel outside this core area to what is known as the

home range. Home range for swift foxes is estimated at 1,850 to 8,500 acres (2.9 to 13.2 mi²). If conditions are favorable, swift fox families' home ranges can overlap. However, recent data provide evidence that swift foxes are territorial, as there is a near total exclusion of an individual's core area from other same-sex individuals (NRCS, 2005).

Population Dynamics

The swift fox is a native to the short-grass and mixed-grass prairies of the Great Plains Region. Until the late 1800s to the early 1900s, swift foxes were common or abundant in North and South Dakota, Montana, Nebraska, Wyoming, Colorado, Kansas, Oklahoma, New Mexico, Texas, and southern portions of Alberta and Saskatchewan. In the 1850s, fox numbers began to decline and by the 1930s only sporadic observations were reported. This decline is largely attributed to inadvertent poisoning from strychnine-laced baits for gray wolves; intense trapping; and modification, degradation, loss, and fragmentation of native grasslands. Approximately 45% of swift fox habitat throughout the historic range has been lost as a result of prairie conversion to cropland. Even where natural prairies remain, they are often fragmented and isolated, reducing habitat and prey while increasing predation and competition. The prairie ecosystem itself has changed due to fire suppression and domestic livestock grazing, making it difficult for populations of swift fox to persist (NRCS, 2005).

The proposed IIFP site contains habitat that has the potential to attract swift fox. The swift fox is known to inhabit Plains-Mesa Sand Scrub and Plains-Mesa Grasslands vegetation types that occur at or in the immediate vicinity of the IIFP site. However, this small fox is more closely associated with grasslands. The swift fox preys primarily on rodents such as kangaroo rats and rabbits, and is closely associated with prairie dogs and other burrowing animals. Breeding habitat requires burrows in relative soft soils that the fox digs or alternatively, it may occupy existing burrows of other animals such as prairie dogs or badgers. Given the existing facilities in the immediate area of the IIFP site and the low population density of the swift fox, the IIFP site is marginally attractive to the swift fox. The swift fox generally requires 1,280 to 2,300 acres of short-grass to mid-grass prairie habitat with abundant prey to support a pair (EPA, 2009a).

3.5.8 Location of Important Travel Corridors

There are no known migratory wildlife species potentially occupying the IIFP 640-acre Section (See Table 3-10); therefore, these species do not have established migratory travel corridors. However, three of the species, mule deer, lesser prairie chicken, and scaled quail, are highly mobile and utilize a network of diffuse travel corridors linking base habitat requirements (i.e., food, water, cover, etc.). Travel corridors for each species may change from season-to-season as well as from year to year and can occur anywhere within the species home range.

Mule deer and scaled quail utilize and often thrive in altered habitats. They can and do live in close proximity to man and human activities. For these two species, any travel corridors that would potentially be disrupted by the Proposed Action would easily and quickly be replaced by an existing or new travel corridor linking base habitat requirements for these two species.

The IIFP 640-acre Section does not provide optimal habitat for the lesser prairie chicken and has not been identified as an important travel corridor for this species.

The sand dune lizard is restricted to areas where sand dune blow-outs, topographic relief, or shinnery oak occur. Thus, the sand dune lizard is not a highly-mobile species and is confined to small home ranges within the active sand dune shinnery oak habitat type. Travel corridors are not important features of the lizard habitat.

Prairie dogs dig extensive, deep and permanent burrows (i.e. they do not migrate) and are not dependent on free water. Thus, the black-tailed prairie dog is not a highly-mobile specie. Travel corridors are not important features of the prairie dog habitat.

3.5.9 Important Ecological Systems

The IIFP 640-acre Section contains fair to poor quality wildlife habitat. The Plains and Great Basin vegetative community has been impacted by past land use practices. The 640-acre Section has been grazed by domestic livestock for over a hundred years and has a U.S. highway along the southern boundary and a New Mexico state highway along the western boundary. The degraded habitat generally lacks adequate cover and water for large animal species.

Based on the published literature, there are no known important ecological systems on the 640-acre Section that are especially vulnerable to change or that contain important species habitats such as breeding areas, nursery, feeding, resting, and wintering areas, or other areas of seasonally high concentrations of individuals of important species. The species selected as important for the site are all highly mobile species, with the exception of the black-tailed prairie dog, and are not confined to the site or dependent on habitats at the site. The Plains and Great Basin vegetation type covers hundreds of thousands of acres in southeastern New Mexico and is not unique to the IIFP 640-acre Section.

3.5.10 Characterization/Significance of the Aquatic Environment

The IIFP 640-acre Section contains no known aquatic habitat and no known rare, threatened and endangered species. There are several intermittent playa water bodies on the IIFP 640-acre Section. There is no hydrological or chemical monitoring station on the 640-acre Section, and no data have been recorded in the past. Since the IIFP 640-acre Section contains no permanent aquatic habitat, the relative regional significance of the aquatic habitat is very low.

3.5.11 Location and Value of Commercial and Sport Fisheries

Due to the lack of aquatic habitat (no permanent surface water), there are no commercial and/or sport fisheries located on the IIFP site or in the local area. The closest fishery, the Pecos River and Lake McMillan located on the Pecos River near Carlsbad, New Mexico, is approximately 105 km (65 mi) west of the IIFP site.

3.5.12 Key Aquatic Organism Indicators

Due to the lack of aquatic life known to exist on the IIFP site, no key aquatic organisms indicators expected to gauge changes in the distribution and abundance of species populations that are particularly vulnerable to impacts from the Proposed Action can be identified.

3.5.13 Importance/Significance of Ecological Systems

There are no known important aquatic ecological systems on site or in the local area that are especially vulnerable to change or that contain important species habitats, such as breeding areas, nursery areas, feeding areas, wintering areas, or other areas of seasonably high concentrations of individuals of important species.

3.5.14 Description of Conditions Indicative of Stress

Pre-existing environmental stresses on the plant and animal communities at the IIFP 640-acre Section consist of power line transmission lines, pipeline installation, two adjacent highways, and domestic livestock grazing. The impact of pipeline and power transmission lines installation and maintenance of the right-of-way has been mitigated by the colonization of the disturbed areas by local plant species.

Historical and current domestic livestock grazing and fencing of the site constitute a pre-existing and continuing environmental stress. Heavily grazed native grasslands tend to exhibit changes in vegetation communities that move from mature, climax conditions to mid-successional stages with the invasion of woody species such as honey mesquite and sagebrush. The IIFP site has large stands of mesquite indicative of long-term grazing pressure that has changed the vegetative community dominated by climax grasses to a sand scrub community and the resulting changes in wildlife habitat.

Another periodic environmental stress is changes in local climatic and precipitation patterns. The IIFP site is located in an area of southeastern New Mexico that experiences shifts in precipitation amounts that can affect plant community diversity and production on a short-term seasonal basis and also on a long-term basis that may extend for several years. Below average precipitation that negatively impacts the plant community also directly alters wildlife habitat and may severely reduce wildlife populations.

Past livestock grazing, fencing and the maintenance of transmission line and pipeline right-of-ways represent the primary pre-existing environmental stress on the wildlife community of the site.

The probable result of the past and current use of the IIFP site is a shift from wildlife species associated with mature desert grassland to those associated with a grassland shrub community. Large herbivore species, such as the pronghorn antelope, that require large, open prairie areas with few obstructions such as fences, have decreased. Other mammalian species that depend on open grasslands such as the black-tailed prairie dog also are no longer present in the immediate area. Bird species that depend on the mature grasslands for habitat such as the lesser prairie chicken have decreased in the region and are not known to inhabit the IIFP site. Other species that thrive in a mid-successional plant community such as the black-tailed jackrabbit, desert cottontail, and mule deer probably have increased (LES, 2005).

3.5.15 Description of Ecological Succession

Long-term ecological studies of the IIFP site are not available for analysis of ecological succession at this specific location. The property is located in a Plains and Great Basin vegetation community, which is a climax community that has been established in southeastern New Mexico for an extended period. The majority of the subject property is a mid-successional stage due primarily to historic and contemporary grazing of domestic livestock and climactic conditions.

Development of the property is limited to adjacent highways, power transmission lines, and gas lines. These areas contain some colonizing plants that are common to disturbed ground.

Regional grazing by domestic livestock has occurred for about 150 years. Reduced grass canopy from historic and contemporary livestock grazing may be contributing to the colonization of mesquite due to reduced competition. Mesquite is considered noxious on rangeland because of its ability to compete for soil moisture and its reproductive ability.

3.5.16 Description of Ecological Studies/Habitat Modeling

The Southwest Regional Gap Analysis Project (SWReGAP) is an update of the Gap Analysis Program’s mapping and assessment of biodiversity for the five-state region encompassing Arizona, Colorado, Nevada, New Mexico, and Utah (USGS, 2009). It is a multi-institutional cooperative effort coordinated by the U.S. Geological Survey Gap Analysis Program. The primary objective of the update is to use a coordinated mapping approach to create detailed, seamless GIS maps of land cover, all native terrestrial vertebrate species, land stewardship, and management status, and to analyze this information to identify those biotic elements that are underrepresented on lands managed for their long term conservation or are “gaps.”

The final land cover map is shown in Figure 3-51 with a subset of land cover classes in the legend. As seen in Figure 3-51, Lea County has several land-cover classes within its boundary instead of a wide-

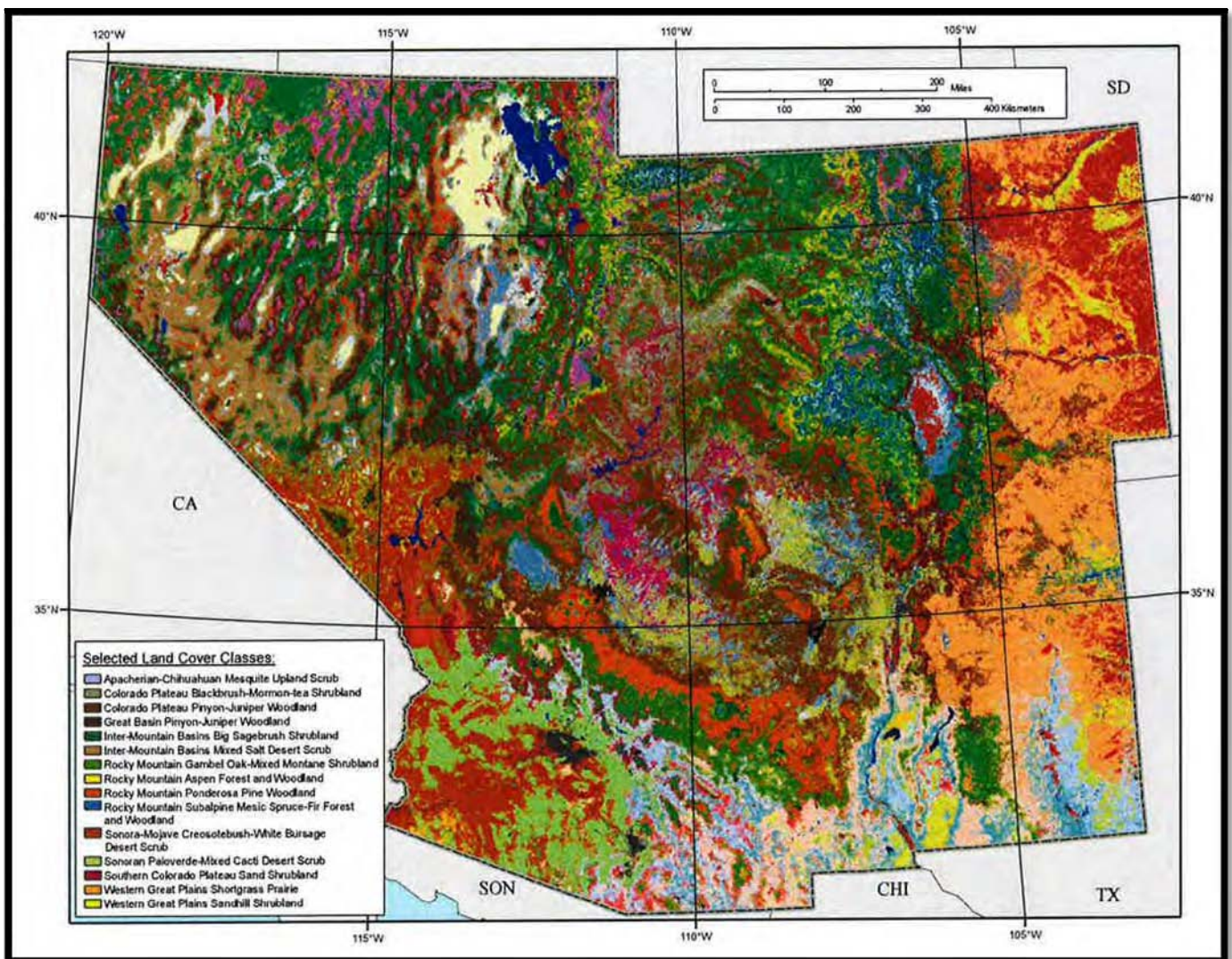

USGS, 2009

Figure 3- 51 Final Land Cover Map Showing a Subset of Land Cover Classes in the Legend

spread land cover class. The data set was searched and eight land cover classes were found for Lea County as delineated below (USGS, 2009):

- **Western Great Plains Sandhill Shrubland** This system is found mostly in south-central areas of the Western Great Plains division ranging from the Nebraska region south to central Texas. The climate is semi-arid to arid for much of the region on which this system occurs. This system is found on somewhat excessively to excessively well-drained, deep sandy soils that are often associated with dune systems and ancient floodplains. In some areas, this system may actually occur as a result of overgrazing in Western Great Plains Tallgrass Prairie or Western Great Plains Sand Prairie.
- **Apacherian-Chihuahuan Mesquite Upland Scrub** This ecological system occurs as upland shrublands that are concentrated in the extensive grassland-shrubland transition in foothills and piedmont in the Chihuahuan Desert. Substrates are typically derived from alluvium, often gravelly without a well-developed argillic or calcic soil horizon that would limit infiltration and storage of winter precipitation in deeper soil layers. Grass cover is typically low. During the last century, the area occupied by this system has increased through conversion of desert grasslands as a result of drought, overgrazing by livestock, and/or decreases in fire frequency.
- **Chihuahuan Mixed Desert and Thorn Scrub** This widespread Chihuahuan Desert land cover type is composed of two ecological systems which include xeric creosote bush basins and plains and the mixed desert scrub in the foothill transition zone.
- **Western Great Plains Shortgrass Prairie** This system is found primarily in the western half of the Western Great Plains Division in the rain shadow of the Rocky Mountains and ranges from the Nebraska Panhandle south into Texas and New Mexico. This system occurs primarily on flat to rolling uplands with loamy, ustic soils ranging from sandy to clayey. Because this system spans a wide range, there can be some differences in the relative dominance of some species from north to south and from east to west. Large-scale processes such as climate, fire and grazing influence this system. High variation in amount and timing of annual precipitation impacts the relative cover of cool and warm-season herbaceous species. The shortgrasses that dominate this system are extremely drought and grazing tolerant. These species evolved with drought and large herbivores and, because of their stature, are relatively resistant to overgrazing. This system in combination with the associated wetland systems represents one of the richest areas for mammals and birds. Endemic bird species to the shortgrass system may constitute one of the fastest declining bird populations.
- **Recently Burned** Areas that have been burned in the recent past that are clearly evident in the imagery acquired between 1999 and 2001.
- **Developed, Open Space – Low Intensity**
 - Open Space: includes areas with a mixture of some construction material, but mostly vegetation in the form of lawn grasses. Impervious surfaces account for less than 20% of total cover. These areas most commonly include large-lot single-family housing units, parks, golf courses, and vegetation planted in developed setting from recreation, erosion, control, or aesthetic purposes.
 - Developed, Low Intensity: Includes areas with a mixture of constructed materials and vegetation. Impervious surfaces account from 20-49% of total cover. These areas most commonly include single-family housing units.
- **Developed, Open Space – Medium Intensity**
 - Developed, Medium Intensity: includes a mixture of constructed materials and vegetation. Impervious surface accounts for 50-79% of the total cover. These areas most commonly include single-family housing units.

- Developed, High Intensity: includes highly developed areas where people reside or work in high numbers. Examples include apartment complexes, row houses and commercial or industrial property. Impervious surfaces account for 80 to 100% of the total cover.
- **Agriculture** An aggregated land cover type that includes both pasture/hay accounting for greater than 20% of total vegetation and cultivated crops where crop vegetation accounts for greater than 20% of total vegetation.

SWReGAP predicted habitat for 820 vertebrate species that reside, breed, or use habitat in the five-state region for a substantial portion of their life history. SWReGAP mapped predicted suitable habitat for all terrestrial vertebrates that breed or use habitat in the region for an important part of their history. Habitat modeling uses, but is not constrained by known occurrence. It also uses probable and possible occurrence to define range limits.

RTE Species or Species of Concern are identified for each land cover type mapped in the Southwest Regional Gap Analysis Project as shown in Table 3-12.

Table 3- 12 RTE Specie or Specie of Concern in Lea County, New Mexico Land Covers

Land Cover Description	Classifications	RTE Specie or Specie of Concern
Western Great Plains Sandhill Shrubland	Scrub/Scrub	Lesser Prairie Chicken Sand Dune Lizard Black-Footed Ferret Peregrine Falcon Western Burrowing Owl Black-Tailed Prairie Dog
Apacherian-Chihuahuan Mesquite Upland Scrub	Scrub/Scrub	Peregrine Falcon Bell's Vireo Western Burrowing Owl
Chihuahuan Mixed Desert and Thorn Scrub	Scrub/Scrub	Aplomado Falcon Peregrine Falcon Western Burrowing Owl Swift Fox
Western Great Plains Shortgrass Prairie	Grassland/Herbaceous	Lesser Prairie Chicken Aplomado Falcon Black-Footed Ferret Western Burrowing Owl Black-Tailed Prairie Dog Swift Fox
Recently Burned	Altered or Disturbed	None Listed
Developed, Open Space – Low Intensity	Developed	Western Burrowing Owl Black-Tailed Prairie Dog
Developed, Medium – High Intensity	Developed	None Listed
Agriculture	Agriculture	Western Burrowing Owl Swift Fox

Source: USGS, 2009

3.5.17 Information of RTE Sightings

Ecological resource field surveys will be conducted to determine any RTE sightings prior to construction activities.

3.5.18 Agency Consultation

Ecological resource consultation has been initiated with appropriate federal and state agencies and local community organizations. Any additional agencies or organizations requiring contact will be consulted, as identified.

3.6 Meteorology, Climatology and Air Quality

In this section, data characterizing the meteorology (e.g., winds, precipitation, and temperature) for the proposed IIFP site are presented along with discussions on severe storms, ambient air quality, and the impact of local terrain features on site meteorology.

3.6.1 On-site Meteorological Conditions

3.6.1.1 Regional Climate

The climate in the region of the proposed IIFP site is semi-arid with mild temperatures, low precipitation and humidity, and high evaporation rate. The weather is often dominated in the winter by a high-pressure system in the central part of the U.S. and a low-pressure system in north central Mexico. The region is affected by a low-pressure system located over Arizona in the summer (WRCC, 2006).

3.6.1.2 Temperature

There are three weather stations in the close proximity to the IIFP site to provide meteorological data. The closest weather station is located at the Hobbs Regional (FAA) Airport just 12.9 km (8 mi) east of the proposed site, while the station with the greatest distance from the site is only 22.5 km (14 mi) away. See Table 3-13 for the listing of the weather stations along with their location and the length of service for providing the weather data.

Table 3- 13 Weather Stations at Hobbs, New Mexico

Station	Latitude/Longitude	Length of Record ¹	Station Elevation meters (feet)
Hobbs	32.686 N/103.117 W	92 (1914 -2006)	1,104 (3,622)
Hobbs FAA Airport	32.698 N/103.337 W	64 (1942-2006)	1,143 (3,749)
Hobbs 13 W	32.637 N/103.313 W	10 (1996-2006)	1,123 (3,684)

¹Years of compiled data
Source: WRCC, 2006

The Hobbs station is a part of the National Climatic Data Center Cooperative Network. Table 3-14 presents a summary of temperatures in the Hobbs area from this monitoring station from 1914 to 2006. 2006 is the latest data available from the Western Regional Climate Center (WRCC). The mean monthly temperature ranged from 42.2°F in January to 80.2°F in July. July is the hottest month with an average maximum of 94°F and an average minimum of 67°F. The daily extreme high temperature is over 100°F for the May through September months. January is the coldest month with a mean of 42°F, a minimum

average of 28°F, and an average maximum of 57°F. The extreme daily high temperature is under 0°F for the months of December, January, and February.

Table 3-15 presents the annual temperature summaries for all three weather stations at Hobbs, New Mexico. The weather station within the city limits of Hobbs and the FAA airport station are in fairly good agreement based on more than 64 years of data. It appears that the temperature has increased over the period 1996 to 2006 based on the data from the Hobbs 13 W station.

Table 3- 14 Summary of Monthly Temperature at Hobbs, New Mexico, from 1914 to 2006

<i>Month</i>	<i>Monthly Averages</i>			<i>Daily Extremes</i>			
	Maximum	Minimum	Mean	High	Date	Low	Date
January	13.6°C (56.5°F)	-2.3°C (27.9°F)	5.7°C (42.2°F)	28.3° 83°F	01/11/1953	21.7°C (-7°F)	01/11/1962
February	16.7°C (62.0°F)	0.0°C (32.0°F)	8.3°C (47.0°F)	30.6°C (87°F)	02/12/1962	18.9°C (-2°F)	02/02/1985
March	20.5°C (68.9°F)	2.9°C (37.4°F)	11.7° (53.2°F)	35.0°C (95°F)	03/27/1971	-17.2°C (1°F)	03/02/1922
April	25.5°C (77.8°F)	7.9°C (46.3°F)	16.7°C (62.1°F)	36.7°C (98°F)	04/30/1928	-7.8°C (18°F)	04/04/1920
May	29.7°C (85.5°F)	13.0°C (55.3°F)	21.4°C (70.5°F)	41.7°C (107°F)	05/30/1951	1.1°C (34°F)	05/02/1916
June	33.8°C (92.9°F)	17.5°C (63.4°F)	25.7°C (78.2°F)	45.6°C (114°F)	06/27/1998	4.4°C (40°F)	06/03/1919
July	34.3°C (93.8°F)	19.2°C (66.7°)	26.8°C (80.2°F)	43.3°C (110°F)	07/15/1958	10.0°C (50°F)	07/01/1927
August	33.4°C (92.1°F)	18.7°C (65.6°F)	26.0°C (78.8°F)	41.7°C (107°F)	08/09/1952	8.3°C (47°)	08/29/1916
September	30.0°C (85.9°F)	15.2°C (59.4°F)	22.6°C (72.7°F)	40.6°C (105°F)	09/05/1948	1.1°C (34°F)	09/23/1948
October	25.1°C (77.1°F)	9.2°C (48.5°F)	17.1°C (62.8°F)	36.7°C (98°F)	10/03/2000	-11.1°C (12°F)	10/29/1917
November	18.5°C (65.2°F)	2.6°C (36.8°F)	10.6°C (51.0°F)	31.1°C (88°F)	11/01/1952	-15.6°C (4°F)	11/29/1976
December	14.4°C (58.0°F)	-1.4°C (29.5°F)	6.6°C (43.9°F)	28.9°C (84°F)	12/09/1922	-17.2°C (-1°F)	12/24/1983

Source: WRCC, 2006

Table 3- 15 Annual Temperature Summaries for all Hobbs, NM Weather Stations

Station	Annual Temperature Summary [°C (°F)]		
	Average Maximum	Average Minimum	Average
Hobbs	24.6 (76.3)	8.6 (47.4)	16.6 (61.9)
Hobbs FAA Airport	24.8 (76.7)	8.0 (46.4)	16.1 (61.0)
Hobbs 13 W	25.1 (77.1)	9.5 (49.1)	17.3 (63.1)

Source: WRCC, 2006

Table 3-16 presents the monthly average number of days less than or equal to 32°F or greater than or equal to 90°F. For July months, 25 to 26 days are hotter than 90°F with June and August having 22 to 24 days hotter than 90°F. For the January and December months, 16 to 22 days are colder than 32°F while the February months will have 12 to 16 days colder than 32°F.

Table 3-17 provides the temperature extremes at the three Hobbs weather monitoring stations. The highest daily maximum temperature on record is 114°F (June 27, 1998), and lowest daily temperature is -11°F (February 1, 1951). The data show extremely varying extremes, but that could be the result of missing data from a particular station for a particular day. One would anticipate good agreement for the

Table 3- 16 Monthly Average Number of Days Maximum Temperature Less Than or Equal to 32°F or Greater Than or Equal to 90°F

Month	Monthly Average Number of Days					
	Hobbs		Hobbs FAA Airport		Hobbs 13 W	
	<=32°F	>=90°F	<=32°F	>=90°F	<=32°F	>=90°F
January	22	0	21	0	16	0
February	15	0	16	0	12	0
March	9	0	11	0	7	0
April	2	2	2	1	1	1
May	0	10	0	9	0	14
June	0	22	0	23	0	22
July	0	25	0	25	0	26
August	0	22	0	24	0	23
September	0	10	0	12	0	12
October	0	2	0	1	0	4
November	9	0	12	0	6	0
December	20	0	21	0	18	0
Year	76	93	84	95	60	103

Source: WRCC, 2006

Table 3- 17 Temperature Extremes at Hobbs, New Mexico

Station	Temperature Extremes [°C (°F)]			
	High	Date	Low	Date
Hobbs	45.6 (114)	June 27, 1998	21.7 (-7)	January 11, 1962
Hobbs FAA Airport	42.2 (108)	July 14, 1958	23.9 (-11)	February 1, 1951
Hobbs 13 W	41.7 (107)	June 25, 1998	16.1 (3)	December 8, 2005

Source: WRCC, 2006

two stations operating for at least 64 years since the extremes for each occurred after both were on line and the stations are within 22.5 km (14 mi) of each other.

Figure 3-52 shows the extremes from the Hobbs weather station. The “Extreme Max.” is the maximum of all daily maximum temperatures recorded for the day of the year, while the “Extreme Min.” records the minimum of all daily minimum temperature. The “Average Max” and the “Average Min” is the average of all daily maximum or minimum temperatures recorded for the day of the year.

3.6.1.3 Precipitation

The average annual total rainfall as measured in Hobbs, New Mexico is 16 inches. Rainfall amounts range from an average 0.45 inch in January to 2.60 inches in September. Maximum and minimum monthly totals are 13.8 inches and zero. Table 3-18 presents a summary of precipitation in the Hobbs area for monthly and annual means from the Hobbs weather station with monitoring data from 1914 to 2006. Total snowfall is also shown in Table 3-18. The mean snowfall is 5.1 inches with a high of 27.1 inches in 1980 at this monitoring location.

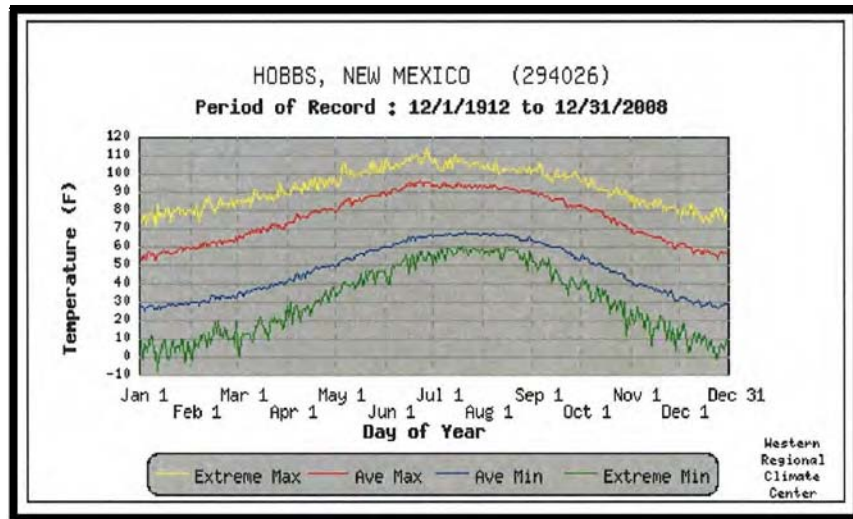

Source: WRCC, 2009

Figure 3- 52 Extreme and Average Daily Temperatures for the Hobbs Station

Figure 3-53 presents the average total monthly precipitation for the Hobbs Station from December 1912 through December 2008. As shown graphically, May through September has the highest total

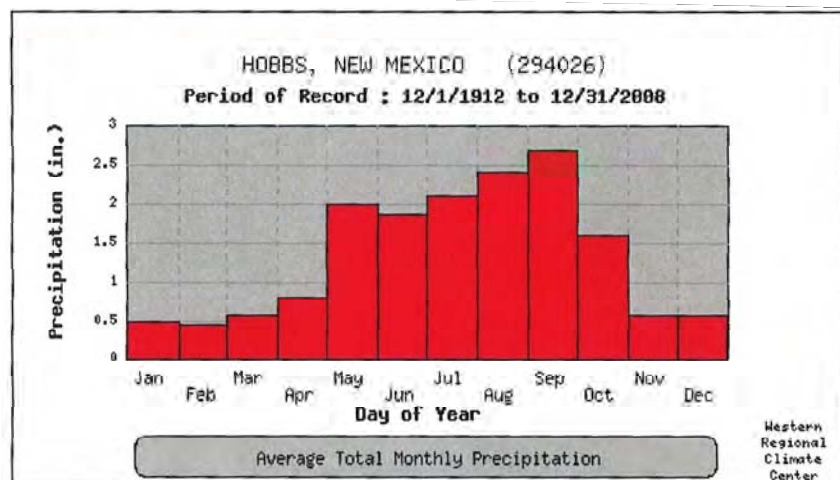

Source: WRCC, 2009

Figure 3- 53 Average Total Monthly Precipitation for the Hobbs Weather Station

Table 3- 18 Summary of Monthly Precipitation at Hobbs, New Mexico, from 1914 to 2006

Month	Rainfall				Total Snowfall				
	Mean	High	Year	Low	Year	1-Day Maximum	Mean	High	Year
January	1.14 cm (0.45 in)	7.52 cm (2.96 in)	1949	0.00	1924	3.07 cm (1.21 in)	3.30 cm (1.3 in)	31.75 cm (12.5 in)	1983
February	1.14 cm (0.45 in)	6.20 cm (2.44 in)	1923	0.00	1917	3.53 cm (1.39 in)	2.79 cm (1.1 in)	36.32 cm (14.3 in)	1973
March	1.40 cm (0.55 in)	7.57 cm (2.98 in)	2000	0.00	1918	5.08 cm (2.00 in)	1.27 cm (0.5 in)	25.40 cm (10.0 in)	1958
April	2.03 cm (0.80 in)	13.13 cm (5.17 in)	1922	0.00	1917	4.75 cm (1.87 in)	0.51 cm (0.2 in)	22.86 cm (9.0 in)	1983
May	5.16 cm (2.03 in)	35.13 cm (13.83 in)	1992	0.00	1938	13.21 cm (5.20 in)	0.0	0.0	1948
June	4.80 cm (1.87 in)	23.62 cm (9.30 in)	1921	0.00	1924	11.23 cm (4.42 in)	0.0	0.0	1948
July	5.33 cm (2.10 in)	23.90 cm (9.41 in)	1988	0.00	1954	11.35 cm (4.47 in)	0.0	0.0	1948
August	6.02 cm (2.37 in)	23.29 cm (9.17 in)	1920	0.10 cm (0.04 in)	1938	11.30 cm (4.45 in)	0.0	0.0	1948
September	6.68 cm (2.60 in)	32.99 cm (12.99 in)	1995	0.00	1939	19.05 cm (7.50 in)	0.0	0.0	1948
October	4.04 cm (1.59 in)	20.70 cm (8.15 in)	1985	0.00	1917	14.22 cm (5.60 in)	.025 cm (0.1 in)	11.43 cm (4.5 in)	1976
November	1.45 cm (0.57 in)	11.00 cm (4.33 in)	1978	0.00	1915	9.65 cm (3.80 in)	1.52 cm (0.6 in)	41.91 cm (16.5 in)	1980
December	1.42 cm (0.56 in)	12.90 cm (5.08 in)	1986	0.00	1917	4.72 cm (1.86 in)	2.29 cm (0.9 in)	24.13 cm (9.5 in)	1986
Annual	40.49 cm (15.94 in)	81.76 cm (32.19 in)	1941	13.41 cm (5.28 in)	1917	19.05 cm (7.50 in)	12.95 cm (5.1 in)	68.83 cm (27.1 in)	1980

cm – centimeter.

In – inch.

Source: WRCC, 2006.

accumulated precipitation, generally from 2-2.5 inches of rain. The winter months generally average 0.5 inch of precipitation.

Summer rains fall almost entirely during brief, but frequently intense thunderstorms. Frequent rain showers and thunderstorms from June through September account for over half the annual precipitation. The general southeasterly circulation from the Gulf of Mexico brings moisture from the storms into the State of New Mexico, and strong surface heating combined with orographic lifting as the air moves over higher terrain causes air currents and condensation. Orographic lifting occurs when air is intercepted by a mountain and is forcefully raised up over the mountain, cooling as it rises. If the air cools to its saturation point, the water vapor condenses and a cloud forms. August and September are the rainiest months with 30 to 40% of the year's total moisture falling during those months. That is also shown graphically in Figure 3-54, "Average Daily Precipitation for the Hobbs, New Mexico Weather Station." The highest daily average is only 0.18 inch. To see the daily fluctuations, Figure 3-55 presents the extreme and the average precipitation at the Hobbs station. Over 7.5 inches of rain has fallen within one day; and a few days, 5 inches of rain has fallen within a day. Obviously, the average precipitation barely registers on the figure with the scale necessary to show the extreme precipitation.

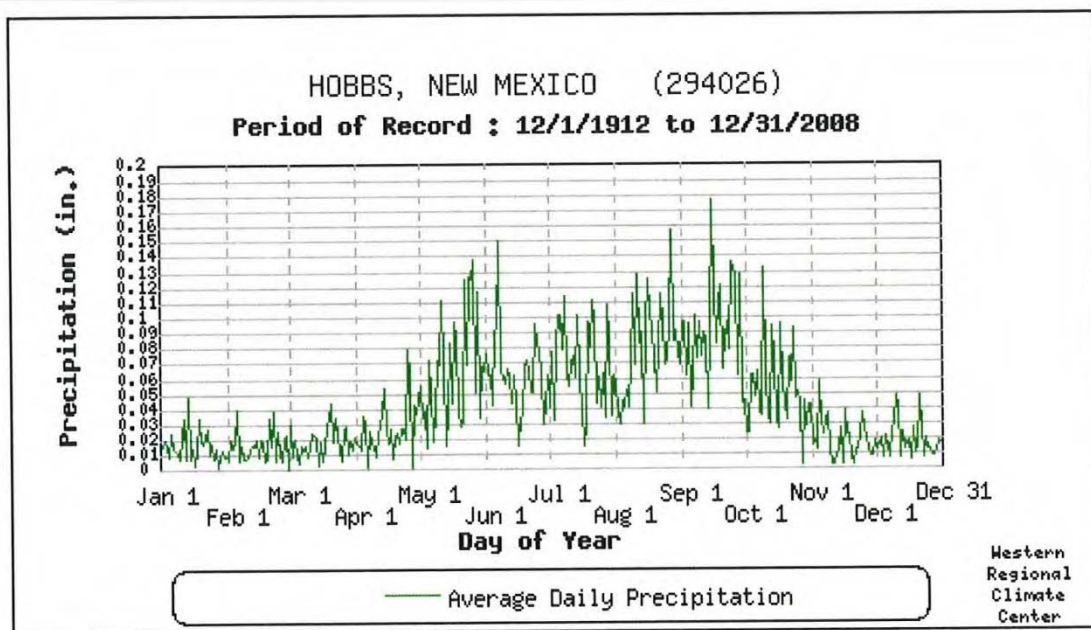

Source: WRCC, 2009

Figure 3- 54 Average Daily Precipitation for the Hobbs, New Mexico Weather Station

As storms move inland, much of the moisture is precipitated over the coastal and inland mountain ranges of California, Nevada, Arizona, and Utah. Much of the remaining moisture falls on the western slope of the Continental Divide and over northern and high-central mountain ranges. Winter is the driest season in New Mexico except for the portion west of the Continental Divide. This dryness is most noticeable in the Central Valley and on eastern slopes of the mountains. In New Mexico, much of the winter precipitation falls as snow in the mountain areas, but it may occur as either rain or snow in the valleys. Climatology data collected from the Midland-Odessa, TX station indicate the relative humidity throughout the year ranges from 45% to 61% with the highest humidity occurring during the early morning hours.

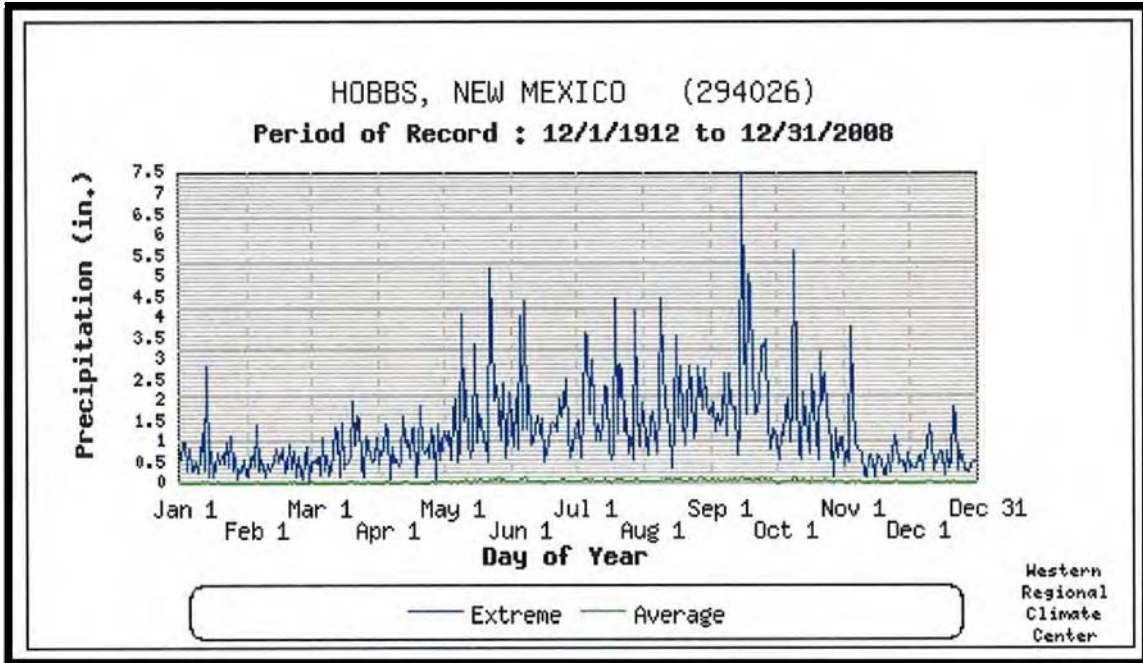

Source: WRCC, 2009

Figure 3- 55 Extreme and Average Precipitation Recorded at the Hobbs Weather Station

As a further indicator as to the arid conditions around Hobbs, Table 3-19 presents the number of days of measurable rainfall at the three weather stations around the IIFP site. The rainfall equals or exceeds 0.5 inches only on 10 days or less. Rainfall measuring at least 1.0 inch only occurs three to four times a year.

Table 3- 19 Number of Days of Measurable Rainfall in Hobbs, NM

Station	Number of Days			
	≥ 0.01 in	≥ 0.1 in	≥ 0.5 in	≥ 1.0 in
Hobbs	44	29	10	4
Hobbs FAA Airport	47	23	8	3
Hobbs 13 W	48	30	10	4

Source: WRCC, 2006

Table 3-20 presents the monthly average number of days when the rainfall is greater than or equal to 0.01 inch. Generally, the winter months will average about 3 days where measurable rainfall (0.01 inch) will fall. Generally in the summer months, only 5 to 6 days will receive measurable precipitation.

In designing the retention/evaporation basins for the 1-hour or 24-hour, 100-year rain event, Table 3-21 provides the data for such an event at the 3 Hobbs weather monitoring stations for both values. The mean with the 90% confidence interval is provided in the table.

3.6.1.4 Wind

Wind speeds over the State of New Mexico are usually moderate, although relatively strong winds often accompany occasional frontal activity during late winter and spring months and sometimes occur just in

Table 3- 20 Monthly Average Number of Day Rainfall Greater Than or Equal to 0.10 Inches

Month	Number of Days		
	Hobbs	Hobbs FAA Airport	Hobbs 13 W
January	3	3	3
February	2	4	4
March	2	2	3
April	3	4	3
May	5	6	4
June	5	4	5
July	5	6	6
August	5	6	5
September	5	4	4
October	4	5	5
November	2	2	3
December	2	1	2

Source: WRCC, 2006

Table 3- 21 Estimates of the 24-Hour 100-Year Rain Event in Hobbs, New Mexico

Station	Rainfall Frequency Estimates 1-Hour Event (24-Hour Event) In Inches ¹		
	Mean (90% Confidence Interval)	Lower Limit (90% Confidence Interval)	Upper Limit (90% Confidence Interval)
Hobbs	3.35 (7.07)	2.93 (6.21)	3.74 (7.81)
Hobbs FAA Airport	3.40 (6.47)	2.99 (5.75)	3.78 (7.10)
Hobbs 13 W	3.41 (6.60)	3.00 (5.82)	3.77 (8.36)

Source: WRCC, 2006

¹ 1 inch = 2.54 centimeters

advance of thunderstorms. Frontal winds may exceed 30 miles/hour (mph) for several hours and reach peak speeds of more than 50 mph. (See Table 3-22).

Spring is the windy season. Winds of 15 mph or more occur from February through May. Blowing dust and serious soil erosion of unprotected fields may be a problem during dry spells. Winds are generally stronger in the eastern plains than in other parts of the State. Winds generally emanate from the southeast in summer and from the west in winter, but local surface wind directions will vary greatly because of local topography and mountain and valley breezes.

In the Environmental Impact Study (EIS) conducted by the Nuclear Regulatory Commission (NRC) for the National Enrichment Facility at Eunice, New Mexico (NRC, 2005), NRC staff examined climatology data from four weather stations in the area. These locations include Eunice, New Mexico; Hobbs, New Mexico; Midland-Odessa, Texas; and Roswell, New Mexico. See Table 3-22, Weather Stations Located near the Proposed IIFP Site, for the distances and directions of these stations from the IIFP Site and the length of the records for the reported data.

Table 3- 22 Weather Stations Located Near the Proposed IIFP Site

Station	Distances and Direction from Proposed Site	Length of Record ¹	Station Elevation (meters)
Eunice, New Mexico	34 km (21 mi) west of site	10 (1993-2003)	1,050
Hobbs, New Mexico	22.5 km (14 mi) south of site	16 (1982-1997)	1,115
Midland-Odessa, Texas	161 km (100 mi) southeast of site	16 (1982-1997)	872
Roswell, New Mexico	120 km (75 mi) northwest of site	16 (1982-1997)	1,118

¹Years of compiled data for climatology analysis.
Source: WRCC, 2006

The data from the NRC study is presented in Figure 3-56, “Wind Roses for Midland-Odessa, Roswell, Hobbs, and Eunice for 1993.” From this one-year comparison, the general wind patterns for Midland-

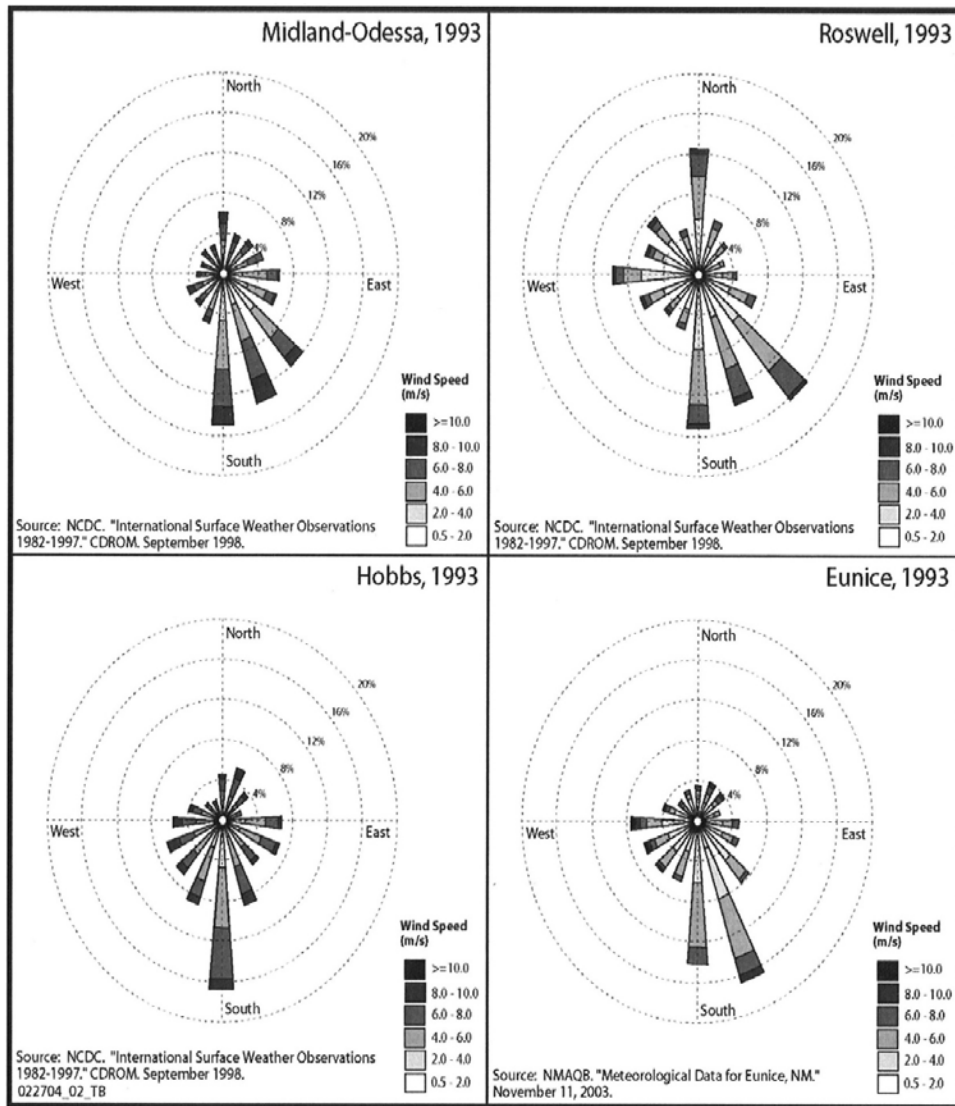

Source: NRC, 2005

Figure 3- 56 Wind Roses for Midland-Odessa, Roswell, Hobbs, and Eunice for 1993

Odessa, Hobbs, and Eunice were somewhat similar. Roswell data, appeared to be different with a stronger northerly and westerly component. The EPA requires that meteorological data be at least 75-percent complete (with less than 25% missing data) to be reliably usable as inputs for dispersion models. Despite the fact that Hobbs is the closest station to the proposed IIFP site, the Hobbs data did not meet the 75-percent completeness criteria. However, Hobbs observations can be used for a general description of the meteorological conditions at the proposed IIFP site. Midland-Odessa and Hobbs had comparable climate data based on a comparative analysis of meteorological data at the four locations surrounding the proposed IIFP site. Since Midland-Odessa was a first-order weather station with data completeness exceeding EPA requirements, NRC used the data from the Midland-Odessa weather station for its dispersion modeling for the EIS for the NEF.

The hourly meteorological observations at Midland-Odessa were used to generate wind rose plots. Monthly wind speeds and prevailing wind directions at Midland-Odessa for the years 1987 to 1991 are presented in Figure 3-57. The annual mean wind speed was 11 mph and the prevailing wind direction was 180 degrees with respect to North. The maximum five second wind speed was 70 mph (NRC, 2005).

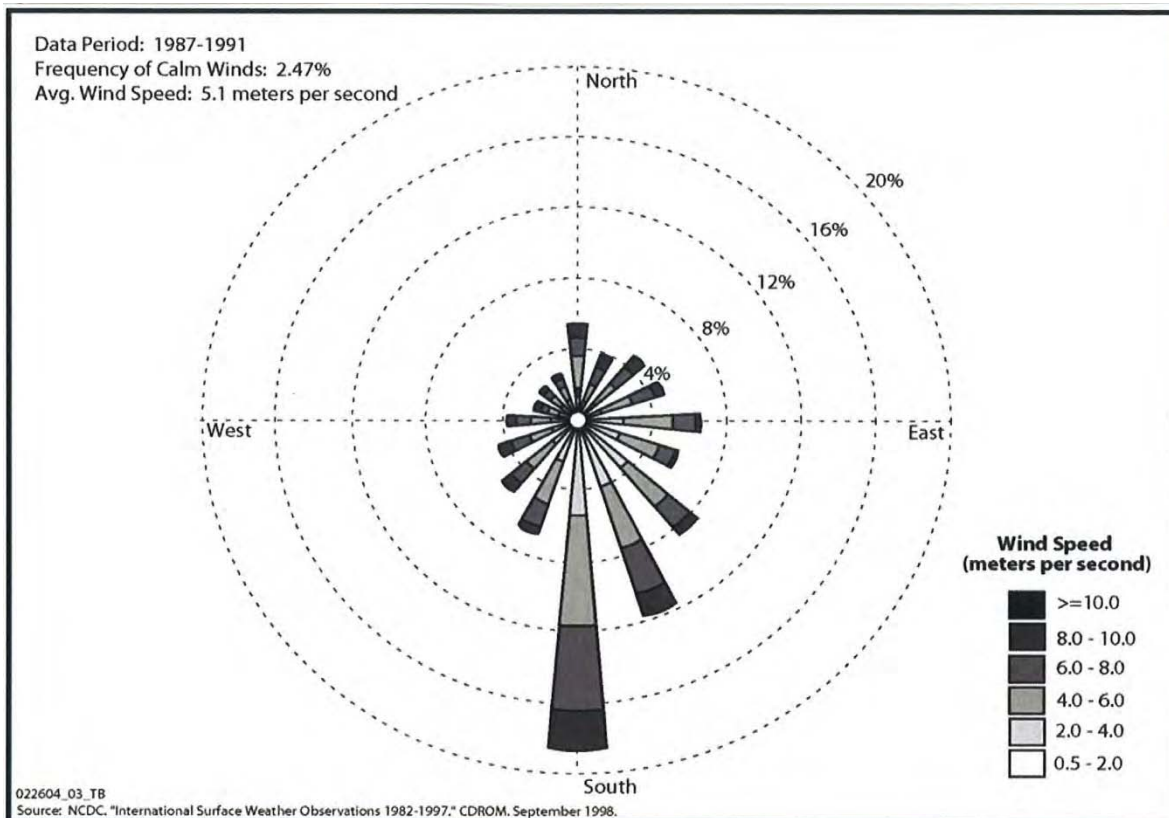

Source: NRC, 2005

Figure 3- 57 Wind Rose for Midland-Odessa, 1987-1991

3.6.1.5 Atmospheric Stability

Five years of data (1987-1991) from Midland-Odessa weather station were used to generate joint frequency distributions of wind speed (Figure 3-58) as a function of Pasquill stability class (A-F). The

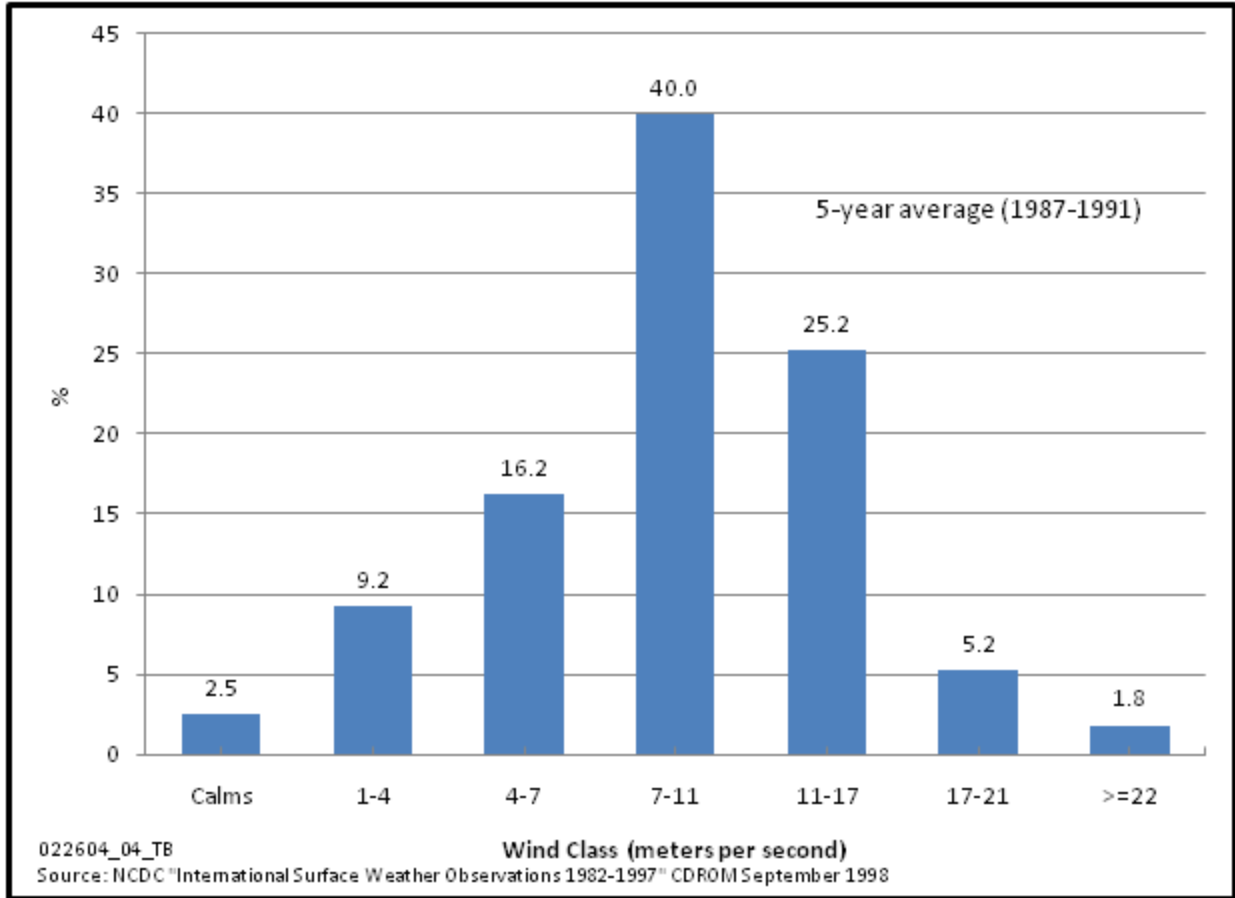

Source: NRC, 2005

Figure 3- 58 Wind Distribution for Midland-Odessa, 1987-1991 (NCDC, 1998)

stability class was determined using the solar radiation/cloud cover method. Figure 3-59, "Distribution of Stability Classes for Midland-Odessa, 1987-1991" presents frequency distributions of wind speed and direction as a function of Pasquill stability class (A-F). The most stable classes (E and F) occur 18.9% and 13% of the time, respectively. The least stable (Class A) occurs 0.4% of the time. Important conditions for atmospheric dispersion, stability class F, and low wind speeds 1 to 3 mph, occur 2.2% of the time. The highest occurrences of the Class F and low wind speeds 1 to 3 mph with respect to wind direction are 0.28% and 0.23% with south and south-southeast winds (NRC, 2005).

Additional wind data for Hobbs and Roswell from 1996 through 2006 are given in Table 3-23. For Hobbs, the average wind speed varied from 10.0 mph for the month of August to 13.4 mph for the month of April. The annual average for Hobbs was 11.4. The prevailing wind direction was out of the north blowing to the south. The wind dynamics were different for Roswell varying from 7.3 mph in December to 11.1 mph in April with annual averages of 8.8 mph. The prevailing wind direction was to the SSE.

3.6.1.6 Storms

Thunderstorms may occur during any month but are most common in the spring and summer months. Thunderstorms occur an average of 36.4 days/yr. The seasonal average are: 11 days in the spring (March through May) and 17.4 days in the summer (June through August); 6.7 days in the fall (September

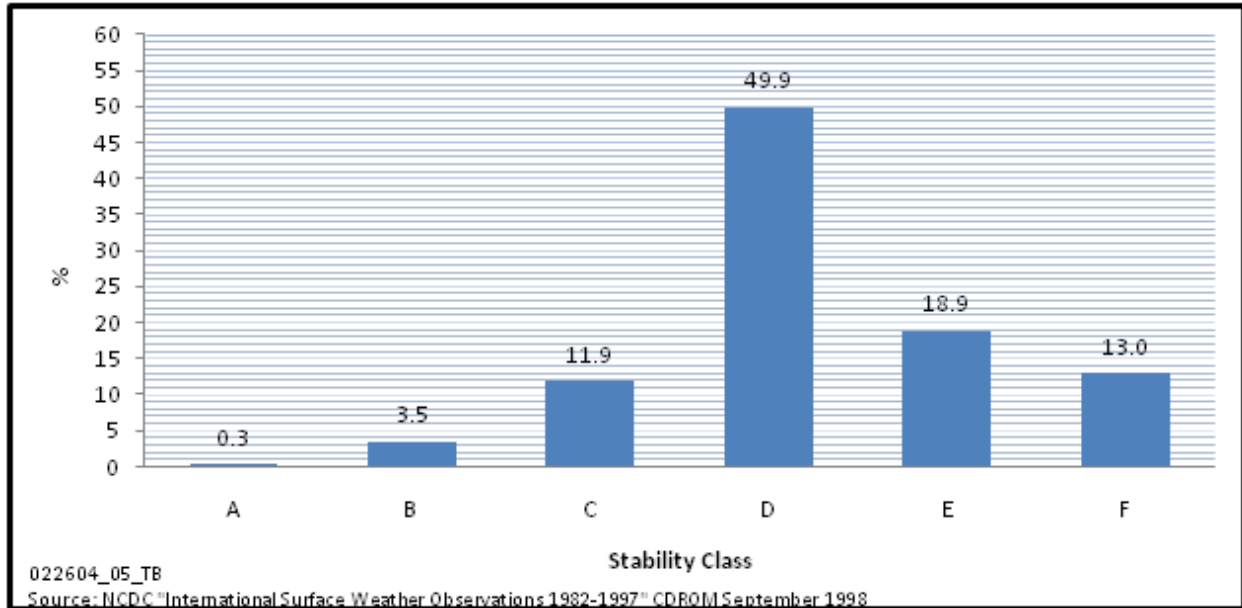

Source: NRC, 2005

Figure 3- 59 Distribution of Stability Classes for Midland-Odessa, 1987-1991

Table 3- 23 Wind Dynamics for Hobbs and Roswell from 1996 to 2006

Month	Hobbs Airport		Roswell Airport	
	Average Wind Speed (mph)	Prevailing Wind Direction	Average Wind Speed (mph)	Prevailing Wind Direction
January	11.3	W	7.4	N
February	11.9	WSW	8.9	SSE
March	12.6	S	9.9	SSE
April	13.4	S	11.1	S
May	12.5	S	10.3	S
June	12.3	S	10.2	SSE
July	11.0	S	8.8	SSE
August	10.2	S	7.9	SSE
September	10.2	S	8.3	SSE
October	10.6	S	8.0	SSE
November	10.7	S	7.5	N
December	11.1	S	7.3	N
Annual	11.4	S	8.8	SSE

Source: WRCC, 2006

through November); and 1.3 days in winter (December through February). Occasionally, thunderstorms are accompanied by hail.

Only two lightning events having sufficient intensity to cause loss of life, injury, significant property damage, and/or disruption to commerce were reported in Lea County, New Mexico, between January 1, 1950 and April 30, 2004 (NCDC, 2004). The closest lightning event occurred in Hobbs with minor property damage of \$3,000 on August 12, 1997. The second occurred in Lovington on August 8, 1996, causing two deaths.

Tornadoes are occasionally reported in New Mexico, most frequently during afternoon and early evening hours from May through August. There is an average of nine tornadoes a year in New Mexico. Tornadoes occur infrequently in the vicinity of the IIFP site. Only two tornadoes were reported in Lea County from 1880 to 1989. Only one tornado was reported in Andrews County, Texas in the same period. See Figure 3-60 showing the Tornado Probability Map of the United States.

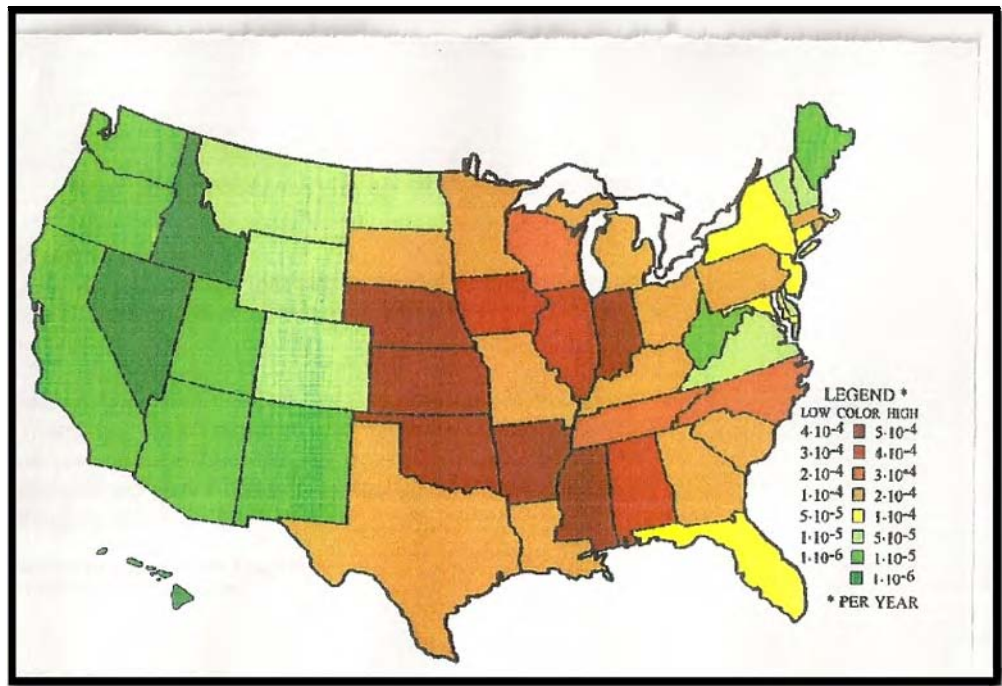

EDCLC, 2008

Figure 3- 60 Tornado Probability Map of the United States (all Intensities)

Hurricanes are low pressure weather systems that develop over the tropical oceans and as they move inward they lose their intensity quickly once they make landfall. The IIFP site is approximately 500 mile from the nearest coast, it is likely that any hurricane that moved in that direction would have downgraded to a tropical depression before it reached the IIFP facility.

3.6.1.7 Mixing Heights

Mixing height is defined as the height above the earth's surface through which relatively strong vertical mixing of the atmosphere occurs. Holzworth developed mean annual morning and afternoon mixing heights for the contiguous United States (EPA, 1972). This information is presented in Table 3-24, Annual Average Morning and Afternoon Mixing Heights. From this table, the mean annual morning and afternoon mixing heights for the IIFP site are approximately 436 m (1,430 ft) and 2,089 m (6,854 ft), respectively.

Table 3- 24 Average Morning and Afternoon Mixing Heights (Midland-Odessa, Texas)

Time of Day	Winter	Spring	Summer	Fall	Annual
Morning	290 meters (951 feet)	429 meters (1,407 feet)	606 meters (1,988 feet)	419 meters (1,375 feet)	436 meters (1,430 feet)
Afternoon	1,276 meters (4,186 feet)	2,449 meters (8,035 feet)	2,744 meters (9,003 feet)	1,887 meters (6,191 feet)	2,089 meters (6,854 feet)

Source: EPA, 1972

3.6.1.8 Sandstorms

Blowing sand may occur occasionally in the area due to the combination of strong winds, sparse vegetation, and the semi-arid climate. High winds associated with thunderstorms are frequently a source of localized blowing dust. Dust storms that cover an extensive region are rare; and those that reduce visibility to less than 1.61 km (1 mi) occur only with the strongest pressure gradients such as those associated with intense extra-tropical cyclones which occasionally form in the area during winter and early spring (DOE, 2003d).

3.6.2 Existing Levels of Air Pollution and Effects on Plant Operations

The EPA uses six criteria pollutants as indicators of air quality (Table 3-25). Concentrations above maximum concentrations may cause adverse effects on human health. These concentrations are referred to as the National Ambient Air Quality Standards (NAAQS). Table 3-26 presents a list of the NAAQS and the State of New Mexico Air Quality Standards. Areas either meet the national primary or secondary air quality standards for criteria pollutants (attainment) or do not meet the national primary or secondary air quality for the criteria pollutants (nonattainment). The criteria pollutants are nitrogen dioxide, ozone, lead, carbon monoxide, particulate matter, and sulfur dioxide.

According to information from the EPA (EPA, 2009d), Lea County is in attainment for all criteria pollutants (Figure 3-61, “Counties Designated Nonattainment for Criteria Air Pollutants”). Air quality in the region is very good. Normal operations at the IIFP facility can result in emissions of the some of the criteria pollutants; these potential emissions are also addressed in ER section 4.6.

The closest monitoring station to the facility by the Monitoring section of the New Mexico Quality Bureau is in Hobbs, New Mexico. The station monitors particulate matter, particles ≤ 2.5 microns and ≤ 10 microns in diameter, and ozone. Summary readings for some of the eight criteria air pollutants from this monitor as well as data for VOCs and NH₃ are presented in Table 3-27, Total Annual Emissions (tons per year) of Criteria Air Pollutants at Lea County, New Mexico, and Andrews and Gaines Counties, Texas. No instances of the particulate matter National Ambient Air Quality Standards being exceeded have been measured by this monitoring station. See Figure 3-61, Counties Designated Nonattainment for Criteria Air Pollutants (EPA, 2009d).

Table 3- 25 Criteria Pollutants

Nitrogen dioxide is a brownish, highly reactive gas that is present in all urban atmospheres. Nitrogen dioxide can irritate the lungs, cause bronchitis and pneumonia, and lower resistance to respiratory infections. The major mechanism for the formation of nitrogen dioxide in the atmosphere is the oxidation of the primary air pollutant nitric oxide. Nitrogen oxides play a major role, together with volatile organic carbons, in the atmospheric reactions that produce ozone. Nitrogen oxides form when fuel is burned at high temperatures. The two major emissions sources are transportation and stationary fuel combustion sources such as electric utility and industrial boilers.

Ozone is a photochemical (formed in chemical reactions between volatile organic compounds and nitrogen oxides in the presence of sunlight) oxidant and the major component of smog. Exposure to ozone for several hours at low concentrations has been shown to significantly reduce lung function and induce respiratory inflammation in normal, healthy people during exercise. Other symptoms include chest pain, coughing, sneezing, and pulmonary congestion.

Lead can be inhaled and ingested in food, water, soil, or dust. High exposure to lead can cause seizures, mental retardation, and/or behavioral disorders. Low exposure to lead can lead to central nervous system damage.

Carbon monoxide is an odorless, colorless, poisonous gas produced by incomplete burning of carbon in fuels. Exposure to carbon monoxide reduces the delivery of oxygen to the body's organs and tissues. Elevated levels can cause impairment of visual perception, manual dexterity, learning ability, and performance of complex tasks.

Particulate matter such as dust, dirt, soot, smoke, and liquid droplets are emitted into the air by sources such as factories, power plants, cars, construction activity, fires, and natural windblown dust. Exposure to high concentrations of particulate matter can affect breathing, causes respiratory symptoms, aggravates existing respiratory and cardiovascular disease, alters the body's defense system against foreign materials, damage lung tissue, and causes premature death.

Sulfur dioxide results largely from stationary sources such as such as coal and oil combustion, steel and paper mills, and refineries. It is a primary contributor to acid rain and contributes to visibility impairments in large parts of the country. Exposure to sulfur dioxide can affect breathing and may aggravate existing respiratory and cardiovascular disease.

Source: EPA, 2009d

There are 80 sources/facilities of criteria pollutants in Lea County, New Mexico, 8 sources in Andrews County, Texas, and 9 sources in Gaines County, Texas listed in the EPA Air Data Monitor Summary Report. In comparison to the areas sizes of the counties, Table 3-28 shows the emissions densities for some of the emission types for Lea County in New Mexico and for Andrews and Gaines Counties in Texas. Emissions densities for these listed emissions are also presented for Bernalillo County where Albuquerque, New Mexico is located and for Dallas and Harris Counties in Texas where Dallas and Houston, respectively, are located.

Table 3- 26 EPA National Ambient Air Quality Standards and State of New Mexico Air Quality Standards

Pollutant	EPA Standard Value*		Standard Type	New Mexico Standard
Carbon Monoxide (CO) 8-hour Average 1-hour Average	9 ppm 35 ppm	(10 mg/m ³) (40 mg/m ³)	Primary Primary	8.7 ppm 13.1 ppm
Nitrogen Dioxide (NO₂) Annual Arithmetic Mean	0.053 ppm	(100 g/m ³)	Primary (P) and Secondary (S)	0.05 ppm
Ozone (O₃) 1-hour Average 8-hour Average	0.12 ppm 0.08 ppm	(235 g/m ³) (157 g/m ³)	(P) and (S) (P) and (S)	None None
Lead (Pb) Quarterly Average	1.5 g/m ³		(P) and (S)	None
Particulate (PM₁₀) Particles with diameters of 10 • m or less				
Annual Arithmetic Mean 24-hour Average	50 g/m ³ 150 g/m ³		(P) and (S) (P) and (S)	60 g/m ³ 150 g/m ³
Particulate (PM_{2.5}) Particles with diameters of 2.5 •m or less				
Annual Arithmetic Mean 24-hour Average	15 g/m ³ 65 g/m ³		(P) and (S) (P) and (S)	None None
Sulfur Dioxide (SO₂) Annual Arithmetic Mean 24-hour Average 3-hour Average	0.03 ppm 0.14 ppm 0.50 ppm	(80 g/m ³) (365 g/m ³) (1,300 g/m ³)	Primary Primary Secondary	0.02 ppm 0.10 ppm None
Hydrogen Sulfide (H₂S) 1-hour Average (not to be exceeded more than once per year)	Not a NAAQS Pollutant		N/A	0.010 ppm
Total Reduced Sulfur ½-hour Average	Not a NAAQS Pollutant		N/A	0.003 ppm

*Parenthetical value is an approximately equivalent concentration
 NAAQS – National Ambient Air Quality Standards
 •m -10⁻⁶ meters or 0.000001 meters ppm – parts per million
 •g/m³ –micrograms per cubic meter mg/m – milligrams per cubic meter
 N/A – not applicable
 Sources: NRC, 2005

3.6.3 Impact of the Local Terrain and Bodies of Water on Meteorological Conditions

Local terrain in the form of hills, valleys and large water bodies can have a significant impact on meteorological conditions. The IIFP 640-acre Section lies in a semi arid region of the southwestern corner of the High Plains. The 640-acre Section is approximately 1,100 m to 1,340 m (3,600 to 4,400 ft) above mean sea level. The 640-acre Section is relatively flat. IIFP expects that there will be no impacts on meteorological conditions from local terrain and bodies of water on site or nearby.

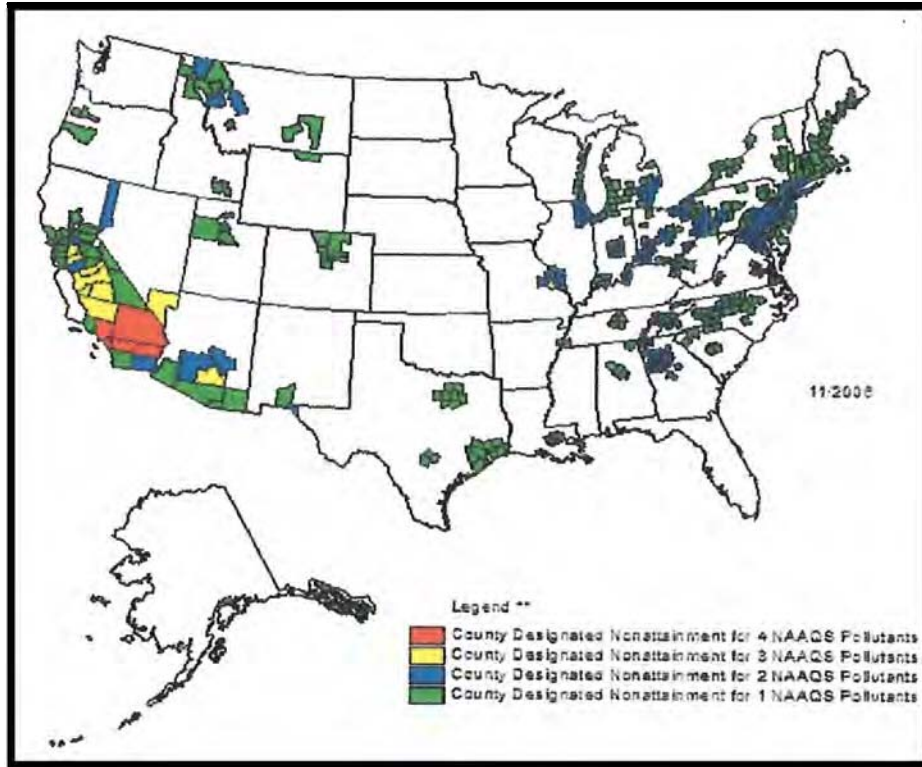

EPA, 2009d

Figure 3- 61 Counties Designated Nonattainment for Criteria Air Pollutants

Table 3- 27 Total Annual Emissions of Air Pollutants at Lea County, New Mexico, and Andrews and Gaines Counties, Texas In Comparison with Larger New Mexico/Texas Counties

County, State	Total Emissions (Tons/Year)							Total
	CO	NO _x	VOC	SO ₂	PM _{2.5}	PM ₁₀	NH ₃	
Lea County, New Mexico	23,417	29,894	4,890	8,084	3,188	27,611	2,101	95,996
Bernalillo County, New Mexico	185,250	24,930	24,310	1,568	8,183	61,892	908	298,857
Andrews County, Texas	7,087	4,729	10,13	2,535	343	2,488	612	28,363
Gaines County, Texas	9,690	4,650	7,107	485	988	6,859	4,971	33,762
Dallas County, Texas	550,278	77,452	75,013	21,488	11,332	60,869	3,238	36,893
Harris County, Texas	763,618	200,053	146,366	57,624	28,858	149,569	7,457	1,316,887

A ton is equal to 0.9078 metric ton
 VOC: volatile organic compounds
 NO_x: nitrogen oxides

SO₂: sulfur dioxide
 PM_{2.5}: particulate matter less than 2.5 microns
 PM₁₀: particulate matter less than 10 microns

CO: carbon monoxide
 Source: Based on 2002 data (EPA, 2009b)

Table 3- 28 Density of Annual Emissions at Lea County, New Mexico, and Andrews and Gaines Counties, Texas In Comparison with Larger New Mexico/Texas Counties

County, State	Emissions Density (Tons/Square Mile)							
	CO	NO _x	VOC	SO ₂	PM _{2.5}	PM ₁₀	NH ₃	Total
Lea County, New Mexico	5.3	6.8	1.1	1.8	0.73	6.3	0.48	21.9
Bernalillo Co. New Mexico	158.9	21.3	20.9	1.3	7.02	53.1	0.78	256.3
Andrews County, Texas	4.7	3.2	7.3	1.7	0.23	1.7	0.41	18.9
Gaines Co., Texas	6.5	3.15	4.7	0.32	0.66	4.6	3.3	22.5
Dallas County, Texas	625.6	88.1	85.3	24.4	12.9	69.2	3.7	896.2
Harris County, Texas	441.7	115.7	84.8	33.3	16.7	81.9	4.3	761.7

A ton is equal to 0.9078 metric ton
VOC: volatile organic compounds
NO_x: nitrogen oxides
CO: carbon monoxide

SO₂: sulfur dioxide
PM_{2.5}: particulate matter less than 2.5 microns
PM₁₀: particulate matter less than 10 microns
Source: Based on 2002 data (EPA, 2009b)

3.7 Noise

Noise is defined as unwanted sounds. At high levels, noise can damage hearing, cause sleep deprivation, interfere with communication, and disrupt concentration. The definition of noise implies adverse effects of people and the environment.

3.7.1 Extent of Noise Analysis

Background noise measurements will be conducted at all four corners of the 640-acre section boundary. The noise background is expected to be between 50 and 60 decibels. The nearest receptors are anticipated to receive the highest noise levels during construction and when the plant is operational. Noise intensity can be affected by factors including weather, foliage, temperature, and land contours.

There are no city, county or New Mexico State ordinances or regulations governing noise. There are no affected Indian tribes within the sensitive receptor distances from the site; therefore, the proposed IIFP site is not subject to federal, State, tribal and local noise regulations.

3.7.2 Community Distribution

The proposed IIFP 640-acre Section is located in a sparsely populated area of southeastern New Mexico that is used primarily for intermittent cattle grazing. The nearest commercial noise receptors are Xcel Energy Cunningham Generating Station on the west property line of the site, the Xcel Energy Maddox Generating Station on the east side, and the Colorado Energy Generating Station on the northeast of the site. The nearest known residential noise receptor is approximately 8.5 km (5.3 mi) northeast of the site.

The ability of an average individual to perceive changes in noise levels is well documented. Generally, an increase of less than 3 dBA is barely perceptible to most listeners, a 5 dBA increase is readily noticeable, and a 20 dBA increase normally is perceived as a doubling of noise. A list of typical community sound levels and noise levels of common sources is shown in Table 3-29.

Table 3- 29 Noise Levels of Common Sources

Sound Source	Sound Pressure Level (dBA)
Air Raid Siren at 50 feet	120
Maximum Levels at Rock Concerts (Rear Seats)	110
On Platform by Passing Subway Train	100
On Sidewalk by Passing Heavy Truck or Bus	90
On Sidewalk by Typical Highway	80
On Sidewalk by Passing Automobiles with Mufflers	70
Typical Urban Area	60-70
Typical Suburban Area	50-60
Quiet Suburban Area at Night	40-50
Typical Rural Area at Night	30-40
Isolated Broadcast Studio	20
Audiometric (Hearing Testing) Booth	10
Threshold of Hearing	0

Source: CEQR, 2001

3.7.3 Background Noise Levels

The primary noise source is vehicle traffic along the southern border of the site on U.S. Highways 62/180 and on the western border of the site on NM 483. Other noise sources included aircraft that operate out of the Lea County Regional Airport approximately 6.4 km (4 mi) from the site.

3.7.4 Topography and Land Use

The 959 ha (2369 ac) site, from which the 242 ha (600 ac) IIFP site would be carved, slopes gently to the south-southwest with a maximum relief of about 12 m (40 ft). The highest elevation is approximately 1,045 m (3,430 ft) msl in the northeast corner of the property. The lowest site elevation is approximately 1,033 m (3,390 ft) msl along the southwest corner of the site. Figure 3-62, Topographic Map of the site shows the topography near the IIFP site. For a close-up topography map of the site, see Figure 3-3, “Topographic Map of the Proposed IIFP Site.”

Rangeland comprises 98.5% of the area within an 8 km (5 mi) radius of the IIFP site, encompassing 12,714 ha (31,415 acres) within Lea County, New Mexico and 7,213 ha (17,823 acres) in Andrews County, Texas. Rangeland is an extensive area of open land on which livestock wander and graze and includes herbaceous rangeland, shrub and brush rangeland and mixed rangeland. Built-up land and barren land constitute the other two land use classifications in the site vicinity, but at considerably smaller percentages. Land cover due to built-up areas, which includes residential and industrial developments, makes up 1.2% of the land use. This equates to a combined total of 243 ha (601 acres) for Lea and Andrews Counties. The remaining 0.3% of land area is considered barren land which consists of bare exposed rock, transitional areas and sandy areas. Refer to ER Section 3.1 for further discussion of land use.

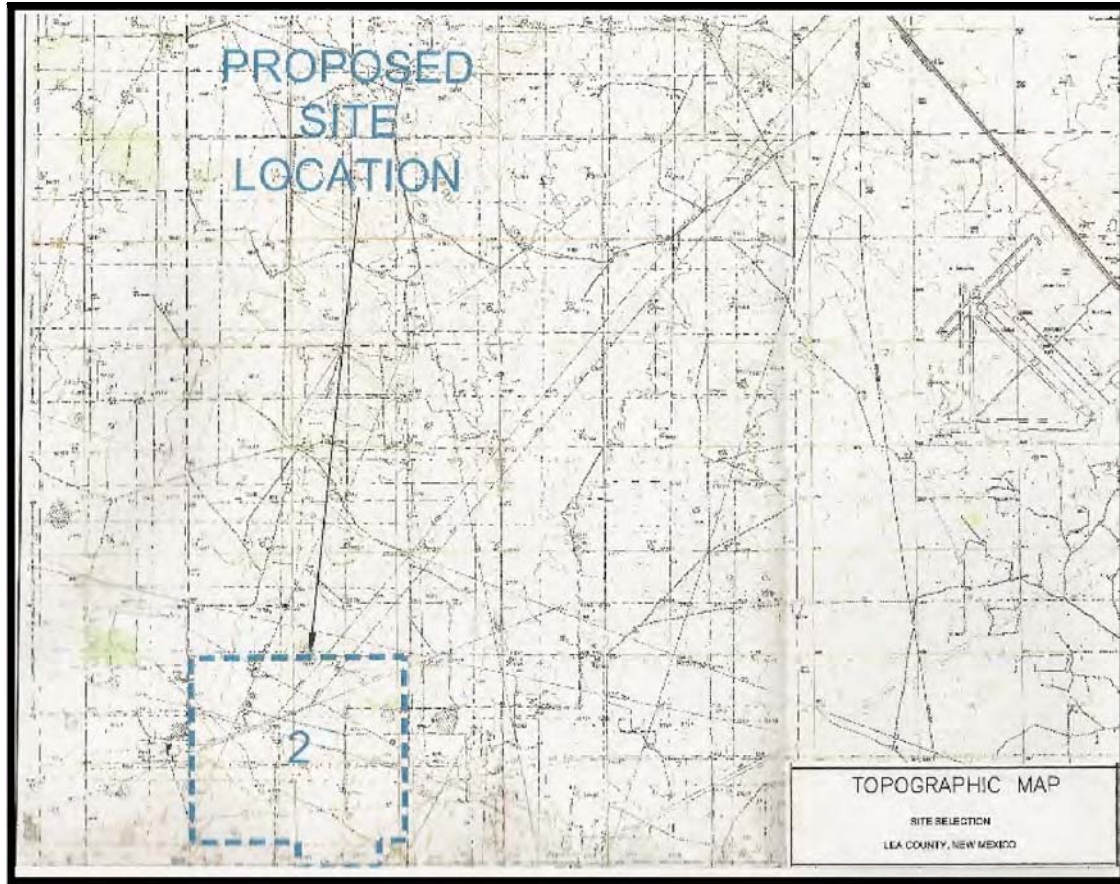

Source: EDCLC, 2008

Figure 3- 62 Topographic Map Around the Proposed IIFP Site

3.7.5 Meteorological Conditions

The meteorological conditions at the IIFP site have been evaluated and summarized in order to characterize the site climatology. See ER Section 3.6, “Meteorology, Climatology and Air Quality,” for a detailed discussion.

The annual mean wind speed at the Midland-Odessa, Texas monitoring station was 4.9 m/hr (11.0 mi/hr) and the prevailing wind direction was from the south, i.e., 180 degrees with respect to true north. The annual mean wind speed at the Roswell, New Mexico station was 3.7 m/hr (8.2 mi/hr) and the prevailing wind direction was wind from 160 degrees from true north. The maximum five-second wind speed was 31.3 m/hr (70 mi/hr) at Midland-Odessa, Texas, and 27.7 m/s (62 mi/hr) from 270 at Roswell, New Mexico.

Noise intensities are affected by weather conditions for a variety of reasons. Snow-covered ground can absorb more sound waves than an uncovered paved surface that would normally reflect the noise. Operational noise can be masked by the sound of a rainstorm or high winds, where environmental noise levels are raised at the point of the noise receptor. Additionally, seasonal differences in foliage, as well as temperature changes, can affect the environmental efficiency of sound wave absorption (i.e., a fully leafed tree or bush will mitigate more sound than one without leaves). Because of those variables, the noise

levels, both background and after the plant is built, will be variable. However, even when such variations are taken into consideration, the noise levels are well within the specified guidelines.

3.7.6 Sound Level Standards

Agencies with applicable standards for community noise levels include the U.S. Department of Housing and Urban Development (HUD, 1985) and the Environmental Protection Agency (EPA, 1973). See Table 3-30, “Site Acceptability Noise Standards as Established by U.S. Department of Housing and Urban Development.” There are no city, county, or New Mexico state ordinances or regulations governing

Table 3- 30 Site Acceptability Noise Standards as Established by U.S. Department of Housing and Urban Development

Standard	Day/Night Average Sound Level (In Decibels)	Special Approval and Requirements
Acceptable	Not exceeding 65 dB ¹	None
Normally Unacceptable	Above 65 db but not exceeding 75 dB	Special Approvals ² Environmental Review ³ Attenuation ⁴
Unacceptable	Above 75 dB	Special Approvals ² Environmental Review ³ Attenuation ⁵

¹Acceptable threshold may be shifted to 70 dB in special circumstances pursuant to Sec. 51.105(a)

²See Sec 51.104(b) for requirements. (When an EIS is required, the concurrence of the Program Assistant Secretary is also required before a project can be approved.)

³See Sec 51.104(b) for requirements. (If an EIS is not required, a Special Environmental Clearance is required if in the Normally Unacceptable zone.)

⁴See Sec 51.104 (a) for requirements. (5 dB additional attenuation is required for sites above 65 dB but not exceeding 70 dB and 10 dB additional attenuation required for sites above 70 dB but not exceeding 75 dB.)

⁵Attenuation measures to be submitted to the Assistant Secretary for CPD for approval on a case-by-case basis

Source: 24 CFR Part 51

environmental noise. In addition, there are no affected American Indian tribal agencies within the sensitive receptor distances from the site. Thus, the IIFP site is not subject either to local, tribal, or State noise regulations. Nonetheless, anticipated IIFP noise levels are expected to fall below the HUD (24 CFR Part 51, Environmental Criteria and Standards) and EPA standards and are not expected to be harmful to the public's health and safety, nor a disturbance of public peace and welfare.

The EPA has defined a goal of 55 dBA for average day-night sound levels (Ldn) in outdoor spaces, as described in the EPA Levels Document (EPA, 1973). HUD has developed land use compatibility guidelines for acceptable noise versus the specific land use.

Especially important in assessing the impact of noise is an understanding of the sound environment at noise-sensitive receptors (NSRs). According to the Federal Highway Administration (FHWA, 1995), NSRs are categorized from A to E depending on the level of human activity normally associated with each (Table 3-31). Category C NSRs are commercial and industrial areas, office buildings, and other developed lands. Noise abatement criteria are more stringent for Category A than Category C NSRs.

Table 3- 31 Federal Highway Administration Noise Abatement Criteria

Activity Category	Hourly A-Weighted Description of Activities	dBA¹
A	Lands or places where preservation of serenity and quiet is essential to continue to serve the intended purpose	57 to 60 (exterior)
B	Picnic, sports, and recreation areas, playgrounds, parks, residences, motels, hotels, schools, churches, libraries, and hospitals	67 to 70 (exterior)
C	Developed lands, properties, or activities not included in Categories A or B above	72 to 75 (exterior)
D	Undeveloped land including roadside facilities and dispersed recreation	None
E	Residences, motels, hotels, public meeting rooms, schools, churches, libraries, hospitals, auditoriums	52 to 55 (interior)

¹These sound levels are only to be used to determine impact. These are the absolute levels where abatement must be considered. Noise abatement should be designed to achieve a substantial noise reduction and simply to satisfy the noise abatement criteria.
Source: FHWA, 1995

3.8 Historic and Cultural Resources

3.8.1 Known Cultural Resources in the Area

The region surrounding the proposed IIFP 640-acre Section in southeastern New Mexico and Western Texas is rich in prehistoric and historic American Indian and Euro-American history. However, the environmental setting in the immediate vicinity of the proposed site has greatly affected both prehistoric and historic occupation and use of the area. This local setting, which occurs well onto the Llano Estacado (see section 3.6, “Geology and Soils”), is a flat, treeless plain lacking nearby permanent or semi-permanent surface water. As a result, the proposed IIFP site was not conducive to extensive human use over the centuries. In contrast to the proposed IIFP site area, shelter and other resources were more readily available at selected locales elsewhere on the Llano Estacado where temporary and some permanent springs and lakes were found.

Southeastern New Mexico has been an area of human occupation for the last 12,000 years. Prehistoric land use and settlement patterns include short- and long-term habitation sites and are generally located on flood plains and alluvial terraces along drainages and on the edges of playas. Specialized campsites were situated along the drainage basins and playa edges. European interactions began in 1541 with a Spanish entrada into the area in search of great riches in "Quivira" by Francisco Vasquez de Coronado. Colonization of New Mexico began in 1595, although settlement in the IIFP region did not occur until the late nineteenth century. The real boom to the region began with the discovery of oil and gas in the region, and most settlement of the region began after the 1930's.

3.8.2 Archaeological or Historical Surveys

3.8.2.1 Physical Extent of the Survey

A pedestrian survey has been completed for the footprint of the IIFP 640-acre Section. See Figure 3-63, “Survey Area Conducted at the IIFP Site.”

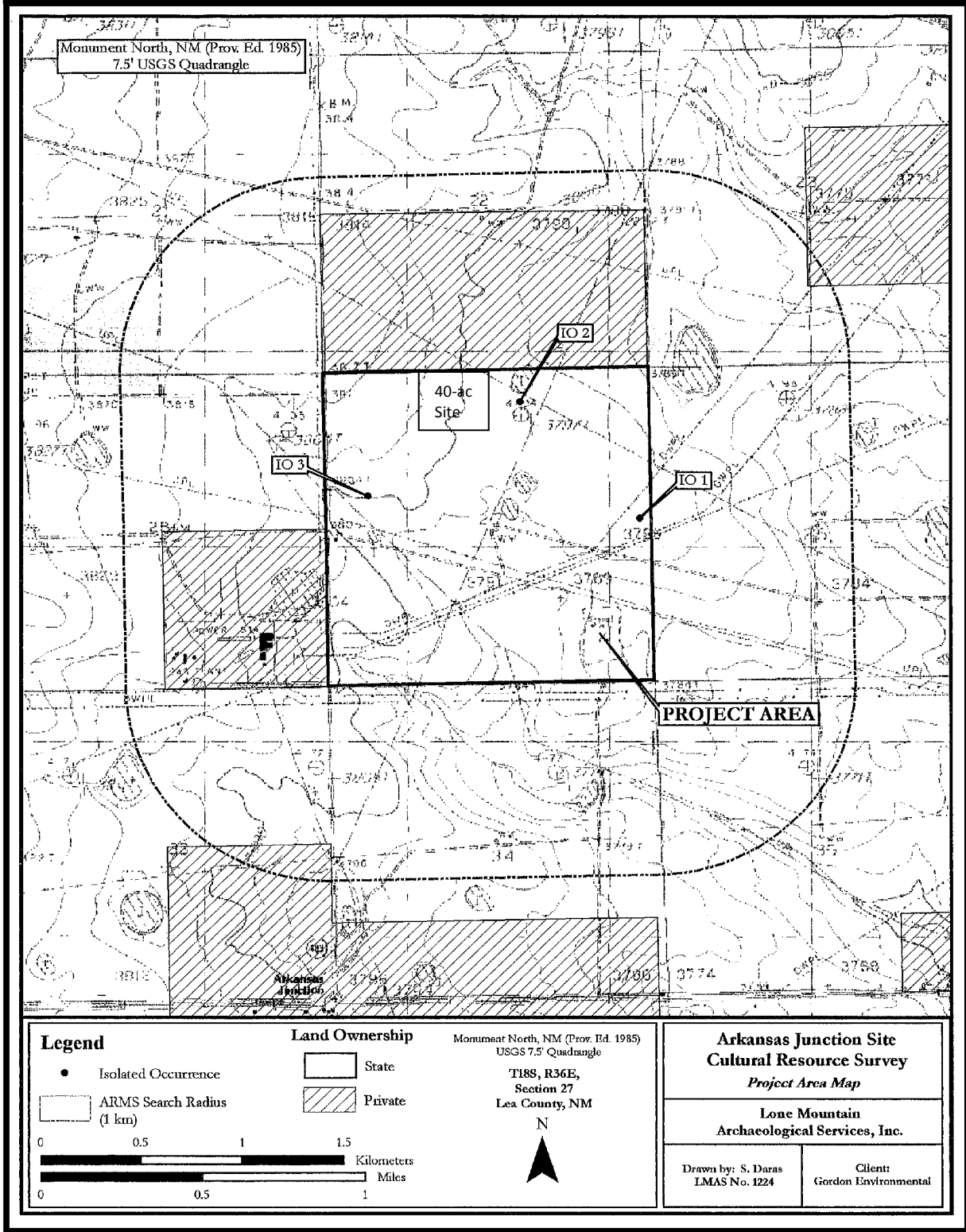

Source: NMCRIS, 2009

Figure 3- 63 Survey Area Conducted at the IIFP Site

3.8.2.2 Description of Survey Techniques

The walk-down survey was conducted to determine if any prehistoric archaeological sites are identified that are potentially eligible for the National Register of Historic Places (NRHP) and to determine if any are located in the Area of Potential Effect (APE). The APE consists of the site and area that includes the building(s) footprints, temporary lay-down areas, entry and site roadways, and the stormwater retention basins. The initial approach was that any potentially eligible archaeological site will either be avoided or a mitigation plan will be developed and implemented if required.

A survey using block survey units [100% coverage at 15 m (49 ft) increments] was conducted on the site May 18-25, 2009 (NMCRIS, 2009). Ground visibility was 100% in burned areas; approximately 45% of the survey area had been burned by recent grass fires. Ground visibility was 75-80% in grassy areas. Vegetation is characteristic of semi-desert grassland.

3.8.2.3 Cultural Resource Specialist Qualifications

The survey at the Lea County, New Mexico proposed IIFP plant was performed using a survey crew with professional experience in historical and prehistoric archaeology in the American Southwest. The crew was supervised in the field by a degreed anthropologist.

3.8.2.4 Survey Findings

Three isolated occurrences of cultural resources were identified. Refer to Figure 3-63, "Survey Area Conducted at the IIFP Site," for the location of these occurrences. Also see Table 3-32 for a description of the occurrences. Files-check yielded three previous NMCRIS activities, but no previously recorded sites within 1 km (0.62 mi) of the project area were found. See Figure 3-64, "Archeological Sites/Surveys Around the IIFP Site."

Table 3- 32 Isolated Occurrences (UTM NAD 27, Zone 13)

IO Number	Northing	Easting	Description
IO 1	3621150	656161	A brown chert San Jose Projectile fragment, distal end, reworked (35 mm x 23 mm) (See Figure 3-65)
IO 2	3621745	655564	One gray quartzite hammerstone, one end and edge battered (53 mm x 43 mm x 26 mm)
IO 3	3621263	654810	Three manganese decolorized glass body fragments ¼ in thick

The absence of cultural resources in the site area may be explained by the presence of shallow sediments with exposed caliche (indicating a lack of lithic raw materials), and a lack of permanent water sources. This may have made the location unattractive to prehistoric peoples.

No other discoveries were made. The isolated occurrences have been completely recorded in a manner consistent with current standards and do not require any additional work (NMCRIS, 2009).

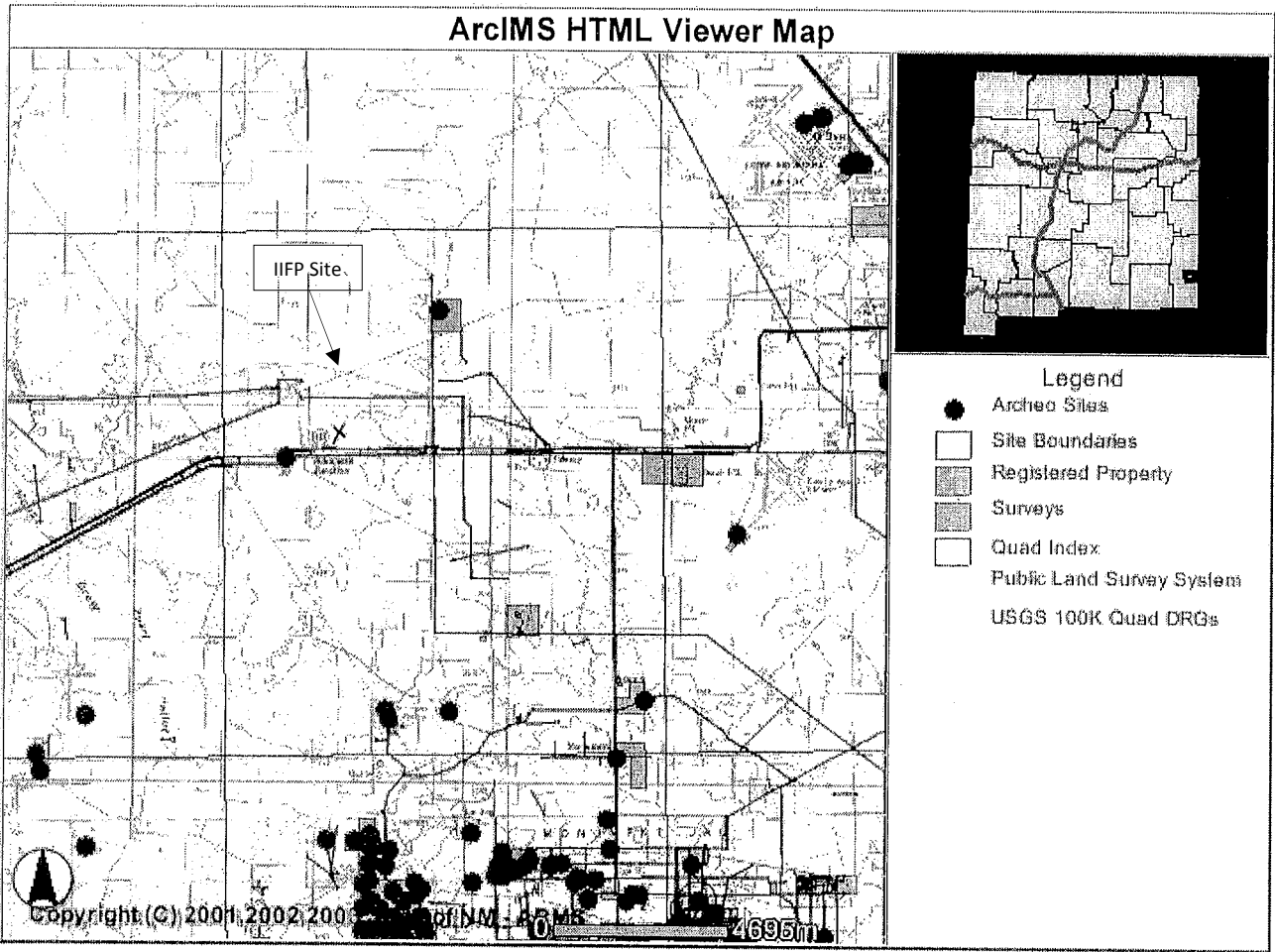

Figure 3- 64 Archeological Sites/Surveys Around the IIFP Site

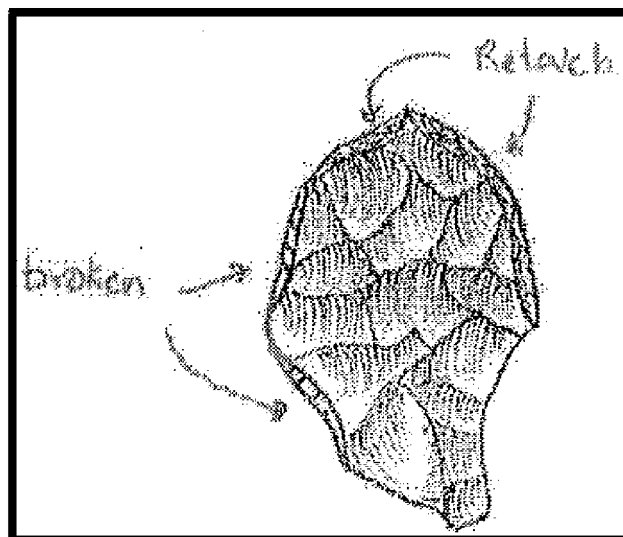

Figure 3- 65 San Jose Projectile Point (IO 1)

3.8.3 List of Historical and Cultural Properties

The listing of the historical/cultural properties discovered at the Proposed IIFP Site is shown in Table 3-32.

3.8.4 Agency Consultation

The cultural resources report which includes the New Mexico Cultural Resources Information System (NMCريس) Abstract Form and two maps have been provided to the State Land Office. Continued consultation is being performed with appropriate federal and state agencies and affected Native American Tribes.

3.8.5 Statement of Site Significance

No archaeological sites were identified from the survey. Pre-licensing construction and general construction of the IIFP facility will have no effect on cultural resources at the site.

3.9 Visual/Scenic Resources

3.9.1 Viewshed Boundaries

Urban development is relatively sparse in the vicinity of the proposed IIFP site. The nearest city, Hobbs, New Mexico, is approximately 22.5 km (14 mi) to the east; the proposed site is not visible from the city. However, the site is visible from traffic on U.S. 62/180 on the southern boundary of the site and on NM 483, which borders the 640-acre Section to the west. Considering distances and that the IIFP plant will be near the center on the section, on-site structures may be visible from nearby locations, but their details will be weak and tend to merge into larger patterns.

3.9.2 Site Photographs

Figure 3-66, "Underground Gas Pipeline Going Southeast to Northwest"

Figure 3-67, "Mark West Pinnacle 2 Lines Going East and West"

Figure 3-68, "Duke Energy Field Services In Approximate Center of Section"

Figure 3-69, "Power Tex and PNM Gas Services Facility in Approximate Center of Section"

Figure 3-70, "Teppco Pipeline Clean Out Trap at Approximate Center of West Side of Section"

3.9.3 Affected Residents/Visitors

Due to neighboring industrial Xcel Energy's Cunningham and Maddox Generating Stations, the Colorado Energy Generating Station, and expansive oil and gas developments in the site vicinity, very few local residents or visitors will be affected aesthetically by changes to the proposed IIFP site.

3.9.4 Important Landscape Characteristics

The landscape of the site and vicinity is typical of a semi-arid climate and consists of caliche soils with desert-like vegetation such as mesquite bushes and native grasses (See Figure 3-66).



BBCI, 2009

Figure 3- 66 Underground Gas Pipeline Going Southeast to Northwest

The IIFP site has numerous power lines and underground pipelines crossing the property as well as various aboveground gas service facilities. See Figure 3-67, Figure 3-68, and Figure 3-69. The 40-acre site location has been chosen to minimize the impact to the IIFP facility from these power lines, pipelines, and gas-service facilities.

Except for man-made structures associated with the neighboring industrial properties and the local oil and gas industry, nearby landscapes are similar in appearance. The only agricultural activity in the site vicinity is domestic livestock ranching.

The proposed site is within the southern part of the Llano Estacado or Staked Plains, which is a remnant of the southern extension of the Southern High Plains. The Southern High Plains are remnants of a vast debris apron spread along the eastern front of the mountains of Central New Mexico by streams flowing eastward and southeastward during the Tertiary period. The site and surrounding area has a nearly flat



BBCI, 2009

Figure 3- 67 Mark West Pinnacle 2 Lines Going East and West

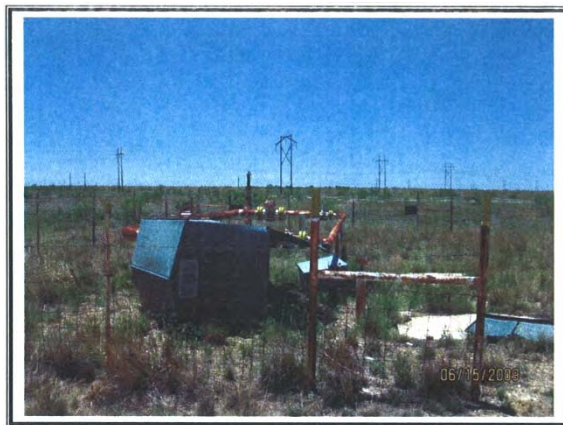

BBCI, 2009

Figure 3- 68 Duke Energy Field Services in Approximate Center of Section



BBCI, 2009

Figure 3- 69 Power Tex and PNM Gas Services Facility in Approximate Center of Section

surface. Natural drainage is south to southeast. Surface drainage is into numerous undrained depressions as well as a small intermittent water tributary running from the northwest to the southeastern boundary.

There are no mountain ranges in the site vicinity. There are a few shallow playas on the site, but no significant bodies of water such as rivers or lakes. There are no parks, wilderness areas or other recreational areas located within or immediately adjacent to the IIFP site. In addition, based on site visits and available local information, there are no architectural or aesthetic features that would attract tourists to the area.

3.9.5 Location of Construction Features

Refer to Figure 3-70 for the location of constructed features on the proposed IIFP site.

3.9.6 Access Road Visibility

Visibility of IIFP facilities from U.S. 62/180 and from NM 483 will be mainly limited to taller on-site structures. This limited visibility is partly due to locating the plant near the center of the property.

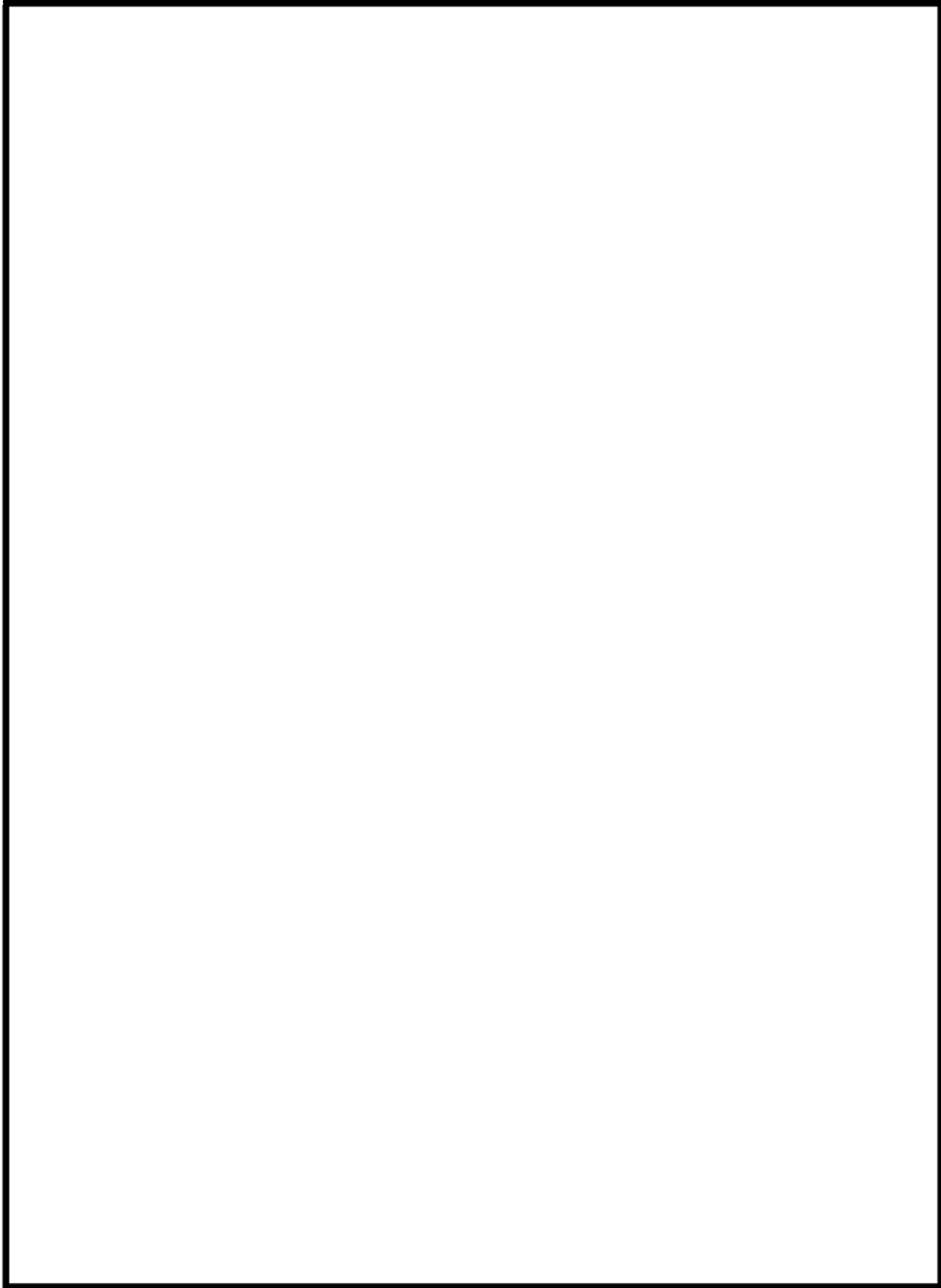

Figure 3- 70 Buildings within the HFP Facility Redacted Security Related Information

3.9.7 High Quality View Areas

Based on site visits and discussion with local officials, there are no regionally or locally important or high quality views associated with the Proposed IIFP Facility. The facility is considered common in terms of scenic attractiveness, given the large amount of land in the area that appears similar.

3.9.8 Viewshed Information

Although the site is visible from neighboring properties and from U.S. 62/180 and NM 483, due to development of nearby land for various industrial purposes and oil and gas exploration, very few local residents or visitors will be affected aesthetically by changes to the site.

3.9.9 Regulatory Information

Currently, the IIFP 640-acre Section is not zoned. There are no local or county zoning, land use planning or associated review process requirements. However, development of the site will meet federal and State requirements for nuclear and radioactive material sites regarding design, siting, construction materials, effluent treatment, monitoring, and licensing. In addition, all applicable local ordinances and regulations will be followed during construction and operation of the IIFP plant.

3.9.10 Aesthetic and Scenic Quality Rating

The visual resource inventory process provides a means for determining visual values (BLM, 2009a; BLM, 2009b). The inventory consists of a scenic quality evaluation, sensitivity level analysis, and a delineation of distance zones. Based on these three factors, lands are placed into one of four Visual Resource Classes. These classes represent the relative value of the visual resources: Classes I and II being the most valued, Class III representing a moderate value, and Class IV being of least value. The classes provide the basis for considering visual values in the resource management planning (RMP) process. Visual Resource Classes are established through the RMP process.

The IIFP site has been evaluated using the BLM visual resource inventory process to determine the scenic quality of the site. The IIFP site falls within Class IV. Class IV is of the least value and allows for the greatest level of landscape modification. The proposed use of the IIFP site does not fall outside the objectives for Class IV, which provides for management activities that require major modifications of the existing character of the landscape.

3.9.11 Coordination with Local Planners

No local or county zoning, land use planning or associated review process requirements are anticipated. Applicable, local ordinances and regulations will be followed during the pre-licensing construction, construction, and operation of the IIFP plant.

3.10 Socioeconomic

This section describes the social and economic characteristics of the 80-km (50-mi) region of influence surrounding the proposed IIFP site including Lea, Eddy, and Chaves Counties in New Mexico, along with Andrews, Gaines, Cochran, Winkler, Loving, and Yoakum Counties County in Texas. See Figure 3-71 “Region of Influence within a 80-km (50-mi) Radius of the IIFP Facility.”

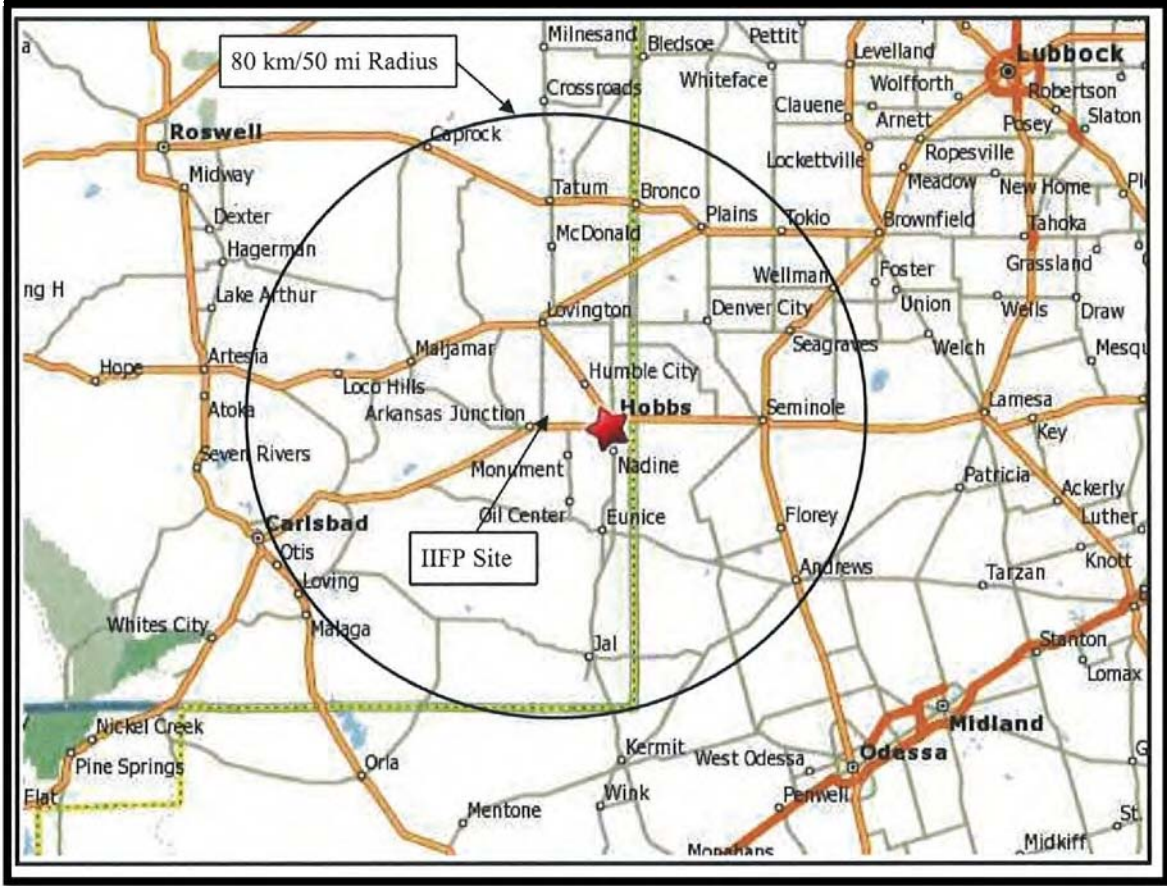

Figure 3- 71 Region of Influence within a 80-km (50-mi) Radius of the IIFP Facility

Information is provided on population, including minority and low-income areas (i.e., environmental justice as discussed in ER Section 4.11), economic trends, housing and community services in the areas of education, health, public safety, and transportation.

The proposed IIFP site is in Lea County, New Mexico. The figure also shows the city of Hobbs, New Mexico, the closest population center to the site, at a distance of about 22.5 km (14 mi). Other population centers are at highway distances from the site as follows:

- Eunice, Lea County, New Mexico: 27 km (17 mi) south
- Jal, Lea County, New Mexico: 56 km (35 mi) south
- Lovington, Lea County, New Mexico: 33 km (20 mi) north-northwest
- Seminole, Gaines County, Texas: 48 km (30 mi) east
- Denver City, Gaines County, Texas: 54 km (33 mi) north-northeast
- Andrews, Andrews County, Texas: 70 km (43mi) southeast

Aside from these communities, the population density around the site region is extremely low. Other communities in Lea County include Buckeye, Caprock, Humble City, Knowles, McDonald, Maljamar, Monument, Oil Center, and Tatum.

The primary labor market for the construction and operation of the proposed facility will be the counties within about 80 km (50 mi) of the site. The majority of the impacts are expected to occur in Lea County, given its larger population and workers living in closer proximity to the proposed IIFP site. Portions of Eddy County and Chaves County, New Mexico, with Gaines, Andrews, Winkler, Yoakum, Loving, and Cochran Counties in Texas are within the region of influence but are not expected to be impacted to any great extent. See Figure 3-72, “Nine-County Area of Influence around the IIFP Site.”

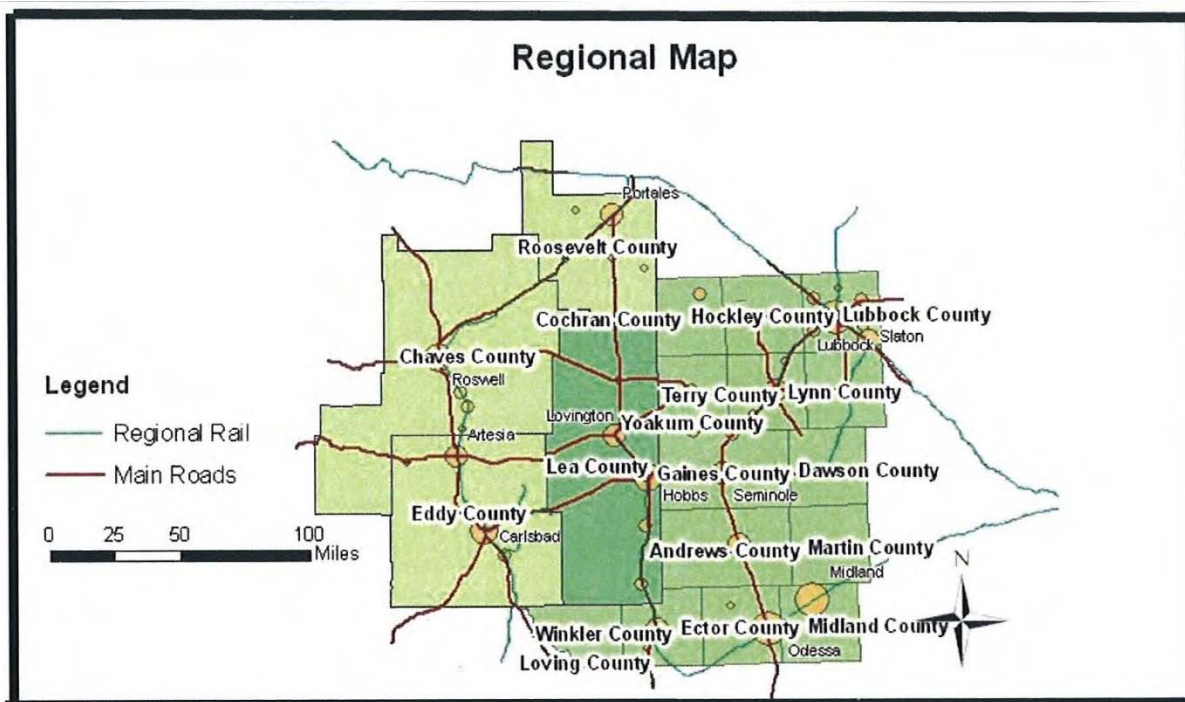

Source: BBER, 2007b

Figure 3- 72 Nine-County Area of Influence around the IIFP Site

Lea County, New Mexico, was established in 1917, five years after New Mexico was admitted to the Union as a State. The county seat is located in Lovington, New Mexico. The site area is very rural and semi-arid. Principal commercial activities are petroleum production and related services, cattle ranching, and the dairy industry. Among U.S. states, New Mexico also ranked 7th in crude oil production in 1999. Lea County, New Mexico ranked first among oil producing counties in New Mexico in 2001.

Lea County covers 11,378 km² (4,393 mi²) or 2,822,522 acres which is three times the size of Rhode Island and only slightly smaller than Connecticut. From north to south, the County spans 174 km (108 mi) with 71 km (44 mi) at its widest point. The county population density is 16% lower than the New Mexico state average (12.6 versus 15.0 population density per square mile). The county housing density is 20% lower than the New Mexico state average (5.3 versus 6.4 housing units per square mile).

The county seat and largest city of Eddy County, New Mexico is Carlsbad. The county has a total area of 10,872 km² (4,198 mi²) or 2,675,200 acres, of which 10,831 km² (4,182 mi²) of it is land and 40 km² (16 mi²) of it is water (0.37%). The lowest point in the state of New Mexico is located on the Red Bluff Reservoir in Eddy County, where the impounded Pecos River flows out of New Mexico and into Texas.

The county seat of Chaves County, New Mexico is Roswell. The county's area comprises 3,885,440 acres, fourth largest county in the state. According to the U.S. Census Bureau, the county has a total land area of 15,723 km² (6,071 mi²) and 11 km² (4 mi²) is water. (0.07%)

The seat of Andrews County, Texas is Andrews. Andrews is named for Richard Andrews, a soldier of the Texas Revolution. According to the U.S. Census Bureau, the county has a total area of 3,888 km² (1,501 mi²), of which 1 km² of it is water (0.02%). The county contains many playa lakes, the two largest being Baird lake and Shafter Lake.

Cochran County, Texas is named for Robert E. Cochran, a defender of the Alamo. The seat of the county is Morton. According to the U.S. Census Bureau, the county has a total area of 2,008 km² (775 mi²) and less than 1 km² (less than 1 mi²) of it is water (0.01%).

Gaines County, Texas is named for James Gaines, a merchant who signed the Texas Declaration of Independence. The seat of the county is Seminole. The county has a total area of 3,892 km² (1,503 mi²) of which 2.6 km² (1 mi) is water (0.03%).

Loving County, Texas is the least populous county in the entire United States. Its seat and only community is Mentone. The nearest sizable towns are Pecos, Texas, and Carlsbad, New Mexico. In 2000, its population was 67. Oil was discovered in 1921, leading to a population increase in Loving County. By 1930 there were 195 residents, mostly living in what would become the town of Mentone. By 1933, the population had peaked at 600, only to enter a steady decline to the present day. Loving County has a total area of 1,753 km² (677 mi²), of which 10 km² (4 mi²) is water (0.56%). The Pecos River is the county's western boundary, forming the Red Bluff Reservoir along its northwestern border with Reeves County, Texas and Eddy County, New Mexico. Loving is the smallest county by area in the Permian Basin region.

The seat of Winkler County, Texas is Kermit. The county has a total area of 2,179 km² (841 mi²), virtually all of which is land. The climate is generally dry. In spring and summer, the hottest daily maximum temperatures in the continental U.S. are often recorded in lower elevation areas near the Pecos River in the county, particularly during the months of April, May, and June.

Yoakum County, Texas has its seat in Plains. Yoakum County contained primarily nomadic buffalo hunters and a few scattered ranchers until after 1900. The county has a total area of 2,071 km² (800 mi²).

3.10.1 Population Characteristics

3.10.1.1 Population Levels in the Region of Influence

In New Mexico, as well as in Texas, the discrepancy between the Census Bureau and the state population estimates may be attributed largely to methodological differences used between the institutions. The Bureau of Business and Economic Research (BBER) uses a bottom-up approach and a housing unit-based method to estimate county populations. Texas also uses a bottom-up approach but employs multiple housing unit based methodologies. The Census Bureau employs a top-down approach that uses the national population as a control total. The independently estimated county populations are summed up and the result is compared to the control total. If the county totals do not add up to the control total, a raking factor is used to force the county population total to equal to the national total. Further, if a county is successful in challenging the Census Bureau estimates, an upward adjustment for this county will mean a downward adjustment in another. Moreover, the use of IRS returns, for reasons presented above, can further distort the county estimates. Inevitably, the Census Bureau estimates end up lower in counties that are sensitive to the weakness of the Census Bureau methodology (BBER, 2008).

Table 3-33 shows the state population estimates for the region of influence from 2000 through 2008 for the three New Mexico counties and the six Texas counties. Table 3-34 presents the U.S. Census growth rate for the region of influence as well as for New Mexico and for Texas. The region of influence increased by 5,252 people from 2000 through 2008 with the three New Mexico counties accounting for approximately 96% of the growth.

The three New Mexico counties grew at a pace of 2.98% as compared to the New Mexico rate of 9.09% over the 2000-2008 span. Lea County had the largest growth over that period at 6.56%. However, Lea County lost population in 2001 and in 2003. All three counties lost population in 2001, and only Chaves County experienced a positive growth in 2003. Chaves County also experienced a positive growth of 2.73% during that time span, while Eddy County lost population slightly at -0.58 percent.

Table 3-33 shows that, overall, the populations in the six Texas counties continue the decline that started since the 1990s. Overall, that population slide continued until 2005 until a slow growth started through 2008. At the county level, population growth was very unstable. From year to year, the county populations went up and down like a roller coaster. Between 2000 and 2008, this region's total population increased by 228 people (0.5%) compared to the Texas growth at 16.14%. Texas's excellent growth was attributable to over a 17% growth in 2005 alone. Andrews County had the biggest gain in population of the six counties, 641 versus 614 for Gaines County. Yoakum County was the only other county exhibiting positive growth at 3.4%. Loving County lost over 37% of its people over that span; however, that amounted to only 25 people.

3.10.1.2 Population Trends in the Region of Influence

Table 3-35 shows that under the most likely scenario, the combined population of the three New Mexico counties is projected to increase from approximately 181,000 in 2010 to almost 215,000 by 2030, which is an 18% increase over a 20-year period. During this period, the relative share of each county will change slightly in favor of Lea County. The region's population is distributed as follows: Chaves County, 36%; Eddy County, 30%; and Lea County, 34%. The resurgence of the oil and gas industry and the increasing role of nuclear energy in the region appear to benefit all three counties. In the future, the county that can diversify its economy and be responsive to the demand for housing will have the comparative population advantage.

Table 3-35 presents data that show Lea County will outpace both Chaves County and Eddy County in total and rate of population growth. The influx of economic migrants who are predominantly in their peak reproductive and productive years will have continued residual effect on the population of Lea County.

Population growth in all three counties will gradually slow, but the Chaves County rate will decelerate faster than that for either Eddy County or Lea County. By the end of the 2030, the population growth rates of Chaves County (0.68%) and Eddy County (0.67%) will converge but Lea County (0.84%) will maintain its lead of both counties. The increase in these counties' growth rate between 2010 and 2015 reflects the impact of the leading edge of the baby boom generation swelling the ranks of the elderly. Advancements in medical research, improvements in the health delivery system, and the relatively healthy lifestyle of baby boomers have resulted in larger numbers surviving to older ages. In Lea County, their impact is muted because of the influx of relatively young migrants during the 2000 decade (BBER, 2007a).

Table 3- 33 State Population Level Estimates for the Region of Influence

Area	Population Estimates as of July 1								
	Census 2000	2001	2002	2003	2004	2005	2006	2007	2008
New Mexico									
Lea	55,511	54,841	58,375	55,225	55,608	55,990	56,793	57,992	59,155
Eddy	51,658	50,676	50,805	50,700	50,803	50,173	50,638	50,960	51,360
Chaves	61,382	60,792	60,433	60,680	60,722	61,189	61,498	62,460	63,060
Total	168,551	166,309	169,613	166,605	167,133	167,352	168,929	171,412	173,575
New Mexico	1,819,041	1,828,330	1,848,986	1,867,909	1,889,266	1,912,884	1,937,916	1,964,402	1,984,356
Texas									
Andrews	13,004	12,761	12,870	12,789	12,759	12,696	12,841	13,120	13,645
Cochran	3,730	3,657	3,491	3,439	3,313	3,261	3,173	3,082	2,977
Gaines	14,467	14,240	14,061	14,154	14,197	14,337	14,555	14,807	15,081
Loving	67	62	66	60	45	54	57	54	42
Winkler	7,173	7,014	6,893	6,630	6,597	6,410	6,425	6,505	6,675
Yoakum	7,322	7,283	7,181	7,166	7,262	7,273	7,255	7,414	7,571
Total	45,763	45,017	44,562	44,238	44,173	44,031	44,306	44,982	45,991
Texas	20,946,049	21,333,928	21,713,397	22,062,119	22,424,884	22,811,128	23,367,534	23,843,432	24,326,974
Region of Influence									
Total	214,314	211,326	214,475	210,843	211,306	211,383	213,235	216,394	219,566

Source: U.S. Census Bureau, 2009

Table 3- 34 State Annual Population Growth Estimates for the Region of Influence

Area	Annual Average Population Growth Rate								
	2000 - 2008	2000 - 2001	2001 - 2002	2002 - 2003	2003 - 2004	2004 - 2005	2005- 2006	2006 - 2007	2007 - 2008
New Mexico									
Lea	6.56	-1.21	6.44	-5.40	0.69	0.68	1.43	2.11	2.01
Eddy	-0.58	-1.90	0.25	-0.21	0.20	-1.24	0.93	0.64	0.78
Chaves	2.73	-0.96	0.59	0.41	0.07	0.77	0.51	1.56	0.96
Total	2.98	-1.33	1.99	-1.77	0.30	0.13	0.94	1.47	1.26
New Mexico	9.09	0.51	1.03	1.02	1.14	1.25	1.31	1.37	1.02
Texas									
Andrews	4.93	-1.87	0.85	-0.63	-0.23	-0.49	1.14	2.17	4.00
Cochran	-20.19	-1.96	-4.50	-1.49	-3.66	-1.57	-2.70	-2.87	-3.41
Gaines	4.24	-1.57	-1.27	0.66	0.30	0.99	1.52	1.73	1.85
Loving	-37.31	-7.46	6.45	-9.09	-25.00	20.00	5.56	-5.26	-22.22
Winkler	-6.94	-2.27	-1.73	-3.82	-0.50	-2.83	0.23	1.25	2.61
Yoakum	3.40	-0.53	-1.40	-0.21	1.34	0.15	-0.25	2.19	2.12
Total	0.50	-1.63	-1.01	-0.73	-0.15	-0.32	0.62	1.53	2.24
Texas	16.14	1.85	1.78	1.61	1.64	17.22	2.44	2.04	2.03
Region of Influence									
Total	2.45	-1.39	1.49	-1.69	0.22	0.04	0.88	1.48	1.47

Source: U.S. Census Bureau, 2009

Table 3- 35 Population Growth Projections in the Region of Influence

County/State	2010	2015	2020	2025	2030
New Mexico					
Lea County	60,962	64,579	67,703	70,578	73,538
Eddy County	54,443	57,008	59,515	61,782	63,882
Chaves County	65,260	68,712	72,015	74,827	77,410
Total	180,665	190,299	199,233	207,187	214,830
New Mexico	2,112,957		2,382,999		2,626,333
Texas					
Andrews County	13,956	14,248	14,259	13,990	13,604
Cochran County	4,142	4,267	4,320	4,282	4,202
Gaines County	16,058	16,698	16,977	16,974	16,867
Winkler County	7,623	7,734	7,739	7,574	7,301
Yoakum County	8,138	8,500	8,663	8,673	8,598
Total	49,917	51,447	51,958	51,493	50,572
Texas	24,395,179		27,917,492		31,197,014
Region of Influence					
Total	230,582	241,746	251,191	258,680	265,402

Source: U.S. Census Bureau, 2009

Table 3-35 also presents the growth rate of the five of the six counties in Texas as well as the three counties in the New Mexico. Loving County was not included due to the very small population of the county. The Texas projections show little to no growth in the five counties adjacent to Lea County. All five counties are expected to have a slight population increase in the next 15 years, after which their populations will gradually decline.

For the region of influence as a whole, the population is projected to remain stable throughout the two decades. Both New Mexico and Texas are expected to continue to experience high population growth rates. IIFP has not identified any programs or planned developments in the region that would have a significant impact on area population.

3.10.1.3 Lea County Population Levels

Figure 3-73 provides a visual depiction of the geographic distribution of the population and the changes that occurred in Lea County during the 1990s. The biggest gainer during this period was unincorporated

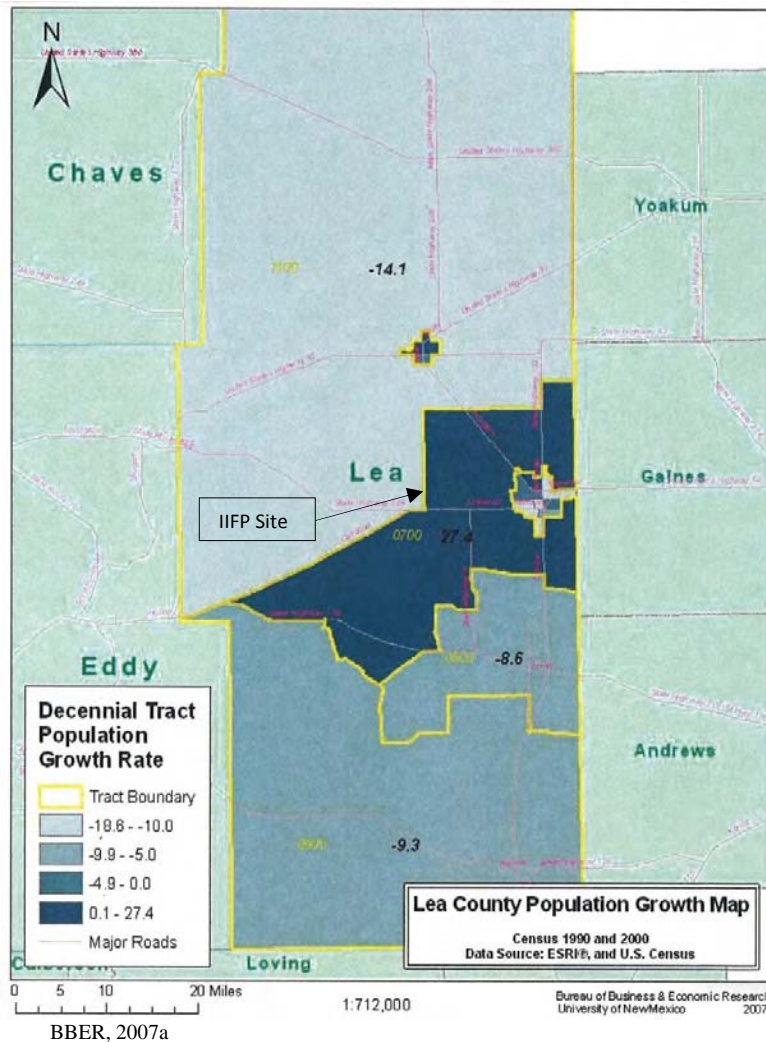

Figure 3- 73 Percent Change in Lea County Between 1990 and 2000, by Census Tract

Hobbs (Census Tract 7.00 in which the IIFP site is located), which upped its 1990 population of approximately 6,300 by 25% or an additional 1,569 people in 2000. In absolute numbers, the biggest loser was the City of Hobbs. In the last decade, it lost over 1,800 people (6.0%). Accordingly, these growth rate differentials changed the relative distribution of the county population.

Table 3-36 shows the population estimates for Lea County for July 1, 2001 to July 1, 2005. BBER estimates for that time period have been consistently higher than the Census Bureau estimates. BBER estimated Lea County's July 1, 2001 population at 55,590 and its July 1, 2005 population at 57,335. The corresponding Census Bureau estimates for the same years were 55,035 and 56,650 people, respectively. Table 3-36 shows that the annual percent change in the population of Lea County did not exceed two-tenths of a percent between April 1, 2000 and July 1, 2003. However, by mid-2003, the population began to rebound. The combination of the rise in the price of oil and the start of construction of the uranium enrichment plant by the Louisiana Energy Services (LES) attracted large numbers of workers to Lea County. Lea County, in general, and the cities of Hobbs and Eunice, in particular, were hard pressed to meet the demand for housing generated by the influx of these economic migrants to the area. In one year, between July 1, 2003 and July 1, 2004, the county population expanded by 1.6% or 874 people, more than triple the population growth between 2000 and 2003. This strong growth has continued through July 1, 2006 (BBER, 2007a).

Table 3- 36 Distribution of Lea County Population Estimates July 1, 2001 to July 1, 2006

Area	Census 2000	2001	2002	2003	2004	2005	2006
Population Estimates as of July 1							
City of Hobbs	28,725	28,634	28,633	28,645	29,011	29,346	29,716
Unincorporated Hobbs	7,906	7,993	8,075	8,184	8,391	8,600	8,802
Hobbs Area	36,631	36,627	36,708	36,829	37,402	37,946	38,518
Eunice Area	2,896	2,889	2,886	2,892	2,939	2,961	3,006
Jal Area	2,118	2,112	2,111	2,112	2,148	2,163	2,200
Lovington Area	9,890	9,930	9,915	9,917	10,080	10,156	10,307
Tatum Area	3,976	4,032	4,024	4,033	4,088	4,109	4,165
Lea County	55,511	55,590	55,644	55,783	56,657	57,335	58,196
Population Distribution (%)							
City of Hobbs	51.7	51.5	51.5	51.4	51.2	51.2	51.1
Unincorporated Hobbs	14.2	14.4	14.5	14.7	14.8	15.0	15.1
Hobbs Area	66.0	65.9	66.0	66.0	66.0	66.2	66.2
Eunice Area	5.2	5.2	5.2	5.2	5.2	5.2	5.2
Jal Area	3.8	3.8	3.8	3.8	3.8	3.8	3.5
Lovington Area	17.8	17.9	17.8	17.8	17.8	17.7	17.7
Tatum Area	7.2	7.3	7.2	7.2	7.2	7.2	7.2
Lea County	100.0	100.0	100.0	100.0	100.0	100.0	100.0

Source: UNM Bureau of Business and Economic Research

Table 3-37 indicates that population recovery in Lea County was geographically uneven. Unincorporated Hobbs continued to lead the rest of Lea County in population growth. From 2003 to 2006, unincorporated Hobbs has grown consistently at over 2% annually. Despite its slower than average annual growth rate, the city of Hobbs has gone from virtually no growth during the previous years to an annual growth rate of

Table 3- 37 Lea County's Annual Growth Rate by Area: July 1, 2000 to July 1, 2006

Area	Annual Average Population Growth Rate (%)						
	2000-2006	2000-2001	2001-2002	2002-2003	2003-2004	2004-2005	2005-2006
City of Hobbs	0.54	-0.25	0.00	0.04	1.27	1.15	1.25
Unincorporated Hobbs	1.72	0.88	1.02	1.34	2.50	2.46	2.32
Hobbs Area	0.80	0.01	0.22	0.33	1.54	1.45	1.50
Eunice Area	0.60	-0.19	-0.10	0.21	1.51	0.75	1.51
Jal Area	0.61	-0.23	-0.05	0.05	1.69	0.70	1.70
Lovington Area	0.66	0.32	-0.15	0.02	1.63	0.75	1.48
Tatum Area	0.74	1.12	-0.20	0.22	1.35	0.51	1.35
Lea County	0.76	0.11	0.10	0.25	1.55	1.19	1.49

Source: UNM Bureau of Business and Economic Research

1.27% between 2003 and 2004. This growth slowed to 1.15% between 2004 and 2005 and rose again to 1.25% between 2005 and 2006. This up and down pattern of growth was more obvious among the smaller areas in Lea County, where even the smallest of change could register as a large variation in the growth rate (BBER, 2007a).

3.10.1.4 Lea County Projected Population Growth

Figure 3-74 presents the geographic distribution of the most likely population projections for the areas in Lea County. Through 2030, all areas in Lea County are expected to increase their populations albeit by

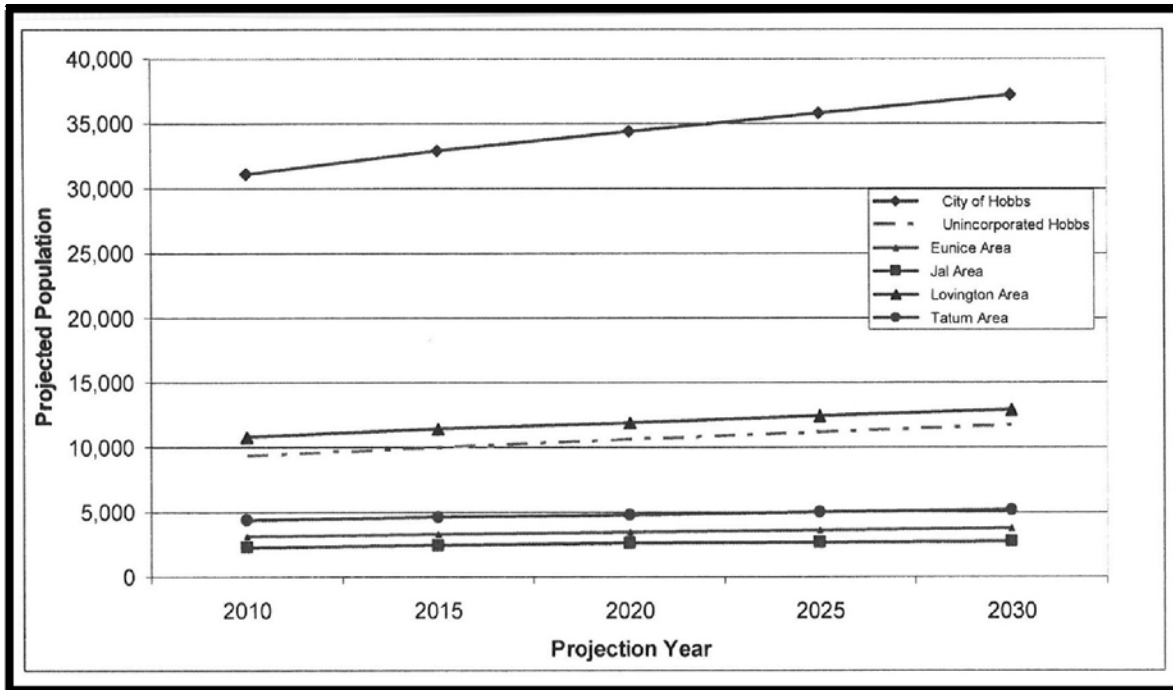

Source: BBER, 2007a

Figure 3- 74 Population Projections by Areas in Lea County Through 2030

varying amounts. Unincorporated Hobbs is projected to have higher than average growth rate while the rest of the county will have lower growth rate. Nevertheless, their relative shares will remain virtually the same. This projected growth in Lea County is predicated on the region's ability to sustain a strong economy and provide the infrastructure to accommodate the anticipated population growth. At least, until 2015, population growth throughout Lea County is expected to be over 1% annually. With the exception of unincorporated Hobbs, the annual average growth rate for the remainder of the county will drop below 1%. The Hobbs area will continue to maintain its demographic dominance in Lea County. In 2010, the Hobbs area will have over 40,000 residents. By 2030, this number will increase to 49,000. Nearly one-quarter (11,694) of this population will be in unincorporated Hobbs. Meanwhile, Lovington's population will grow from 10,800 in 2010 to 13,000 by 2030. Eunice is projected to add over 600 people between 2010 and 2030. The population of Jal will increase from 2,300 in 2010 to 2,800 by 2030 while Tatum will have more than 5,000 residents by 2030 (BBER, 2007a).

3.10.1.5 Minority Population

Based on U. S. census data, the minority populations of Lea County, New Mexico and Andrews County, Texas as of 2000 were 32.9% and 22.9%, respectively. These percentages are consistent with their respective state averages of 33.2% and 29.0%. The raw census data was tabulated and used to calculate the above percentage statistics. No other sources of data or information were used. By far, the largest population center in Lea County is Hobbs which also has the largest minority population. See Section 4.11.2 for the ethnic breakdown for Hobbs, New Mexico.

The relatively higher fertility and lower mortality rate among the minorities partially accounted for the population growth in Lea County. The category "Minority" includes individuals who identified themselves as "White Hispanic or Latino," American Indian, Black, Asian and Pacific Islander. "Hispanic or Latino" is an ethnicity, not a race. It is a subset of the Minority race category. The number of Minority births is inversely related to the number of Anglo births. Minority births have been increasing while Anglo births have been decreasing. The proportion of minority births in Lea County has increased from 55% in 1990 to 70% in 2005 whereas the proportion of Anglo births decreased from 45% in 1990 to 29% in 2000 (BBER, 2007a). This race reversal is the result of a combination of the following demographic phenomena: the influx of Minorities into Lea County; the exodus of Anglos due to the instability of Lea County's economy; and differential fertility rates between these two groups. The overall pattern in death rates indicates very little change in the proportion of deaths by race. The proportion of Anglos among the dead fluctuated around 80% while the proportion of Minorities hovered around 20%. The disparities in fertility and mortality rates between Anglos and Minorities, the strong presence of Minorities, primarily Hispanics, among recent migrants, and the aging of the baby boom generation, which in this case is predominantly Anglo, will accelerate the racial changeover in Lea County, from an Anglo to a Minority majority population. The differential growth patterns among the races in Lea County are shown graphically in Figure 3-75. Since 1995, deaths have outnumbered births in the aging Anglo population. In contrast, among the relatively younger Minority population, births outnumbered deaths by a large margin (BBER, 2007a).

Figure 3-75 illustrates this sharp contrast in the components of population change among the races in Lea County. The social and economic implications of these demographic patterns are intriguing. An aging population has different health, housing, transportation, and social needs from that of a young population. The aging Anglo population will require retirement and nursing homes, health facilities with specialized care, and age appropriate recreational facilities and services. The young Minority population will require schools, childcare services and facilities, jobs, and housing that can accommodate a growing family (BBER, 2007a).

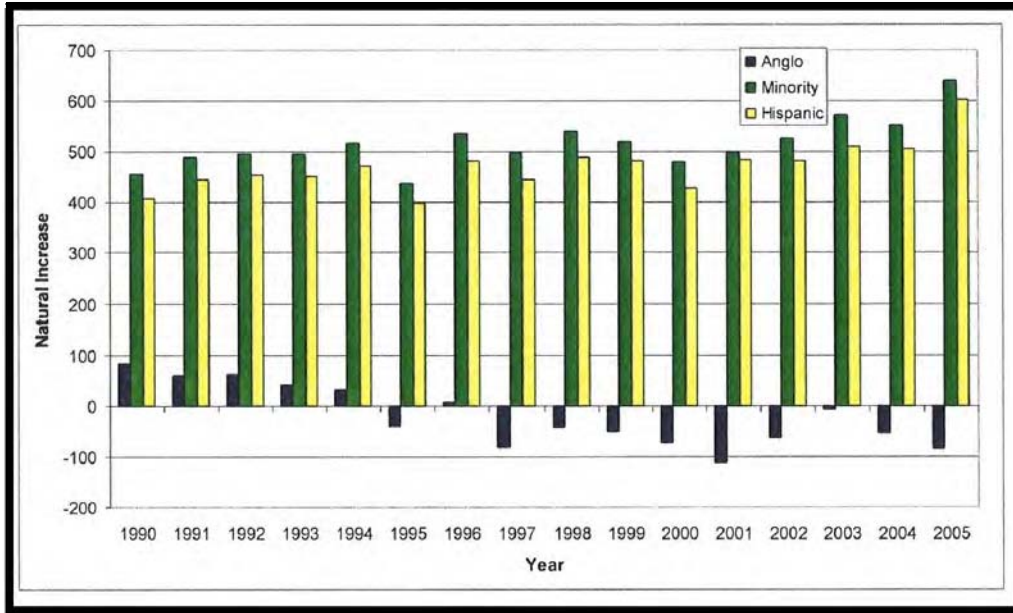

Source: UNM Bureau of Business and Economic Research; NM Department of Health

Figure 3- 75 Natural Increase in Lea County, by Race/Ethnicity: 1990 to 2005

The term “minority population” is defined for the purposes of the U. S. Census to include the five racial categories of black/African American, American Indian or Alaska Native, Asian, Native Hawaiian or other Pacific Islander, and some other race. It also includes those individuals who declared two or more races, an option added as part of the 2000 census. The minority population, therefore, was calculated to be the total population less the white population. In contrast to U. S. Census data, NUREG-1748, Appendix C (NRC, 2003a) defines minority populations to include individuals of Hispanic or Latino origin. Thus there is a difference between the minority population data discussed here and presented in Table 3-38, “Percentage of Minority and Low-Income Census Block Groups Within 80 Kilometers (50 Miles) of the Proposed IIFP Site,” and the data presented in ER Section 4.11, “Environmental Justice.”

The U.S. Census data were used to calculate the minority population reported above consistent with the U.S. Census definition of minority population. The same data were also used in the Environmental Justice assessment (see ER Section 4.1.1), which manipulated the census data to yield minority population estimates consistent with the NRC definition applicable to environmental justice.

3.10.2 Economic Characteristics

3.10.2.1 Historical Employment Trends for Lea County

To provide a sense of how the Lea County economy has performed over the past three and a half decades, Figure 3-76 compares the percentage change in total average annual employment for Lea County with that for New Mexico and the U.S. The figures on total employment include full- and part-time wage and salary workers and those who are self-employed as farm and non-farm proprietors. The large fluctuations for Lea County reflect the county’s relatively small employment base as compared with New Mexico and the U.S. Clearly, however, the Lea County economy is frequently out of sync with what is happening both nationally and in New Mexico.

Table 3- 38 Percentage of Minority and Low-Income Census Block Groups Within 80 Kilometers (50 Miles) of the Proposed IIFP Site

County/State	Total Census Block Groups in County	Below Poverty Level	African American/Black	Native American	Asian and Pacific Islander	Other Races	Two or More Races	Hispanic or Latino (All Races)	Minorities (Racial Minorities plus White Hispanics)	Total Minority Block Groups
State of New Mexico (%)	—	18.4	2.1	10.2	1.4	19.0	0.6	42.1	55.3	—
Threshold for EJ Concerns (%)	—	38.4	22.1	30.2	21.4	39.0	20.6	50.0/42.1	50.0	—
State of Texas (%)	—	15.4	11.7	0.9	3.0	13.0	0.4	32.0	47.6	—
Threshold for EJ Concerns (%)	—	35.4	31.7	20.9	23.0	33.0	20.4	50.0/32.0	50.0	—
<i>Number of Block Groups Meeting Environmental Justice Criteria</i>										
Eddy County	3	0	0	0	0	0	0	1	1	1
Lea County	63	8	1	0	0	15	0	28	29	31
New Mexico Counties	66	8	1	0	0	15	0	29	30	32
Andrews County	15	0	0	0	0	1	0	11	6	11
Ector County	5	0	0	0	0	0	0	3	1	3
Gaines County	13	0	0	0	0	1	0	10	4	10
Loving County	1	0	0	0	0	0	0	0	0	0
Terry County	1	0	0	0	0	0	0	1	0	1
Winkler County	10	1	0	0	0	1	0	9	3	9
Yoakum County	6	0	0	0	0	1	0	6	2	6
Texas Counties	51	1	0	0	0	4	0	40	16	40
Grand Total	117	9	1	0	0	19	0	69	46	72

Sources: NRC, 2005

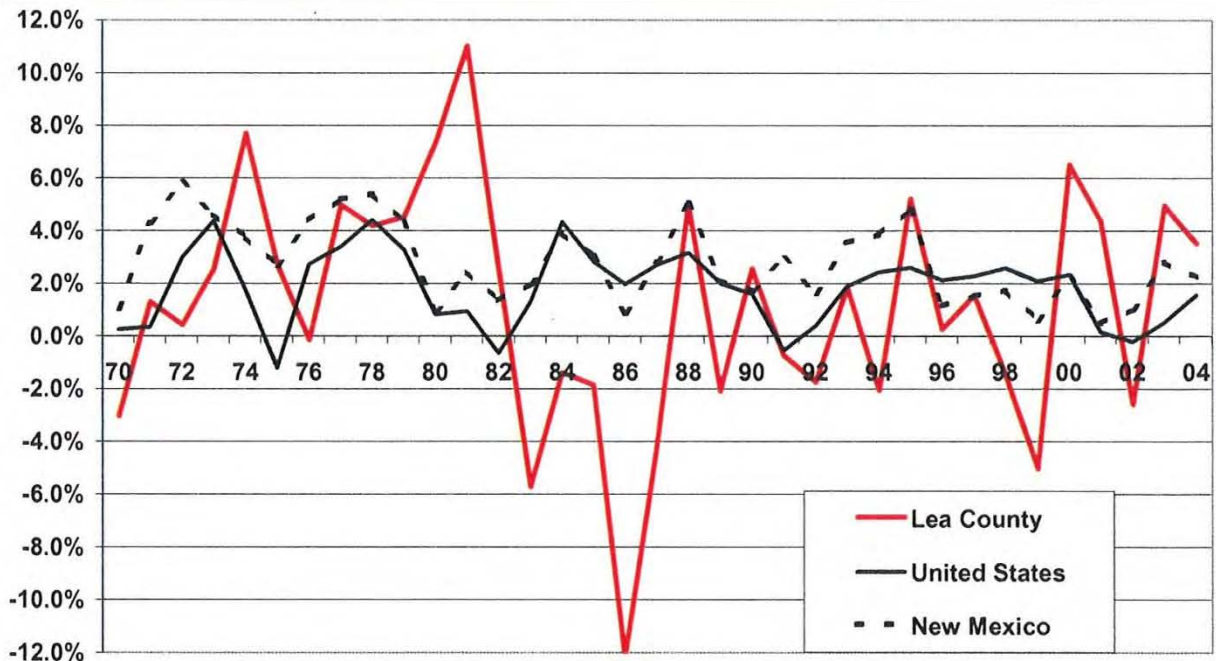

Source: US Bureau of Economic Analysis

Figure 3- 76 Comparison of Annual Growth in Total Employment for Lea County, New Mexico, and the United States

When Lea County’s employment performance is considered along with that for groups of counties within the larger region, it is evident that Lea County and the counties in the region often move together. The effects in Lea County may be more pronounced (again, the base is smaller), but when Lea County employment surges, a pickup in growth is frequently in evidence for the groupings of other counties. The counties in the region often rise together; so also do they fall (BBER, 2007b).

3.10.2.2 Employment, Jobs, and Occupational Patterns for the Region of Influence

In 2000, the civilian labor force of Lea County, New Mexico was 22,302, as shown in Table 3-39, Employment in the Region of Influence. Of these, 2,032 were unemployed in Lea County, New Mexico, for an unemployment rate of 9.1%. The unemployment rate was higher by about 2% than that for rest for the state (DOC, 2002). Eddy County had the lowest unemployment level at 6.8%. For the three counties, over 5,800 people were unemployed for an 8.3% rate.

The unemployment rate was 8.1% in Andrews County, Texas while the unemployment rate for Gaines County was less at 5.5%. The unemployment rate for the Texas counties in the region of influence was higher than the Texas average. About 1,500 people in the six Texas counties were unemployed for a rate of 7.7% which is significantly higher than the 6.0% rate for Texas. Interestingly, all 42 in-labor force personnel for Loving County were employed.

Table 3-40 shows the unemployment rate for the 9 counties in the region of influence from 2001 through 2006. Lea County had a fairly consistent drop in the unemployment rate ranging from 5.4% in 2002 to 3.2% in 2006. Total employment increased almost 21% between 2000 and 2006. Eddy and Chaves Counties also had drops in the unemployment rate through the same time span from 7.4% down to 3.2%.

Table 3- 39 Employment in the Region of Influence for Census Year 2000

Entity	In-Labor Force	Employed	Unemployed	Unemployment Rate
New Mexico				
Chaves County	25,361	23,028	2,285	9.1
Eddy County	22,104	20,591	1,494	6.8
Lea County	22,302	20,254	2,032	9.1
Total	69,767	63,873	5,811	8.3
New Mexico	834,632	763,116	60,324	7.2
Texas				
Andrews Co. TX	5,511	5,064	447	8.1
Cochran Co TX	1,500	1,334	166	11.1
Gaines Co. TX	5,776	5,460	316	5.5
Loving Co. TX	42	42	0	0
Winkler Co. TX	2,790	2,561	229	8.2
Yoakum Co. TX	3,152	2,861	291	9.2
Total	18,771	17,322	1,449	7.7
Texas	9,937,150	9,234,372	596,187	6.0
Region of Influence				
Total	88,538	81,642	7,260	8.2

Source: BBER, 2007b

Table 3- 40 Unemployment Rate for the Region of Influence (2001-2006)

Entity	2001 (%)	2002 (%)	2003 (%)	2004 (%)	2005 (%)	2006 (%)
New Mexico						
Chaves County	5.6	6.5	7.4	6.9	5.9	4.5
Eddy County	5.0	5.9	6.0	5.7	4.8	3.6
Lea County	4.3	5.4	5.3	5.0	4.2	3.2
New Mexico	4.9	5.5	5.9	5.8	5.3	4.2
Texas						
Selected Rural Counties ¹	4.6	5.6	5.8	5.3	4.7	4.4
Andrews County	4.3	5.5	5.5	4.7	4.0	3.5
Winkler County	5.6	8.7	7.4	6.1	4.7	4.1
Yoakum County	4.3	5.4	5.5	5.1	4.6	4.3
Texas	5.8	6.6	6.5	5.6	5.3	4.6

¹Includes Cochran, Gaines, and Loving Counties
Source: BBER, 2007b

Eddy County had an 11.3% increase in the number of employed since 2000; while Chaves County only had a 5.6% increase in the number of employed personnel since 2000. The New Mexico exhibited a similar decline in the unemployment rate, dropping from a high of 7.2% unemployment level in 2000 down to 4.2% in 2006 (BBER, 2007b).

The Texas counties had similar unemployment trends as their counterpart counties in New Mexico. Andrews County unemployment percent rate dropped from a high of 5.5 down to 3.5 in 2006. Employment in Andrews increased 27% from the year 2000. The selected rural counties which included Gaines, Cochran, and Loving had similar declines in the unemployment rates (BBER, 2007b).

Table 3-41 presents the breakdown of employment in the various industries for the New Mexico counties for the year 2000. The largest percent in all three counties are employed in the educational, health and social services sector at 20%. Lea County also has a 20.7% employed in the mining and agriculture industry while Chaves and Eddy Counties have 9.9 and 14.3%, respectively, employed in that sector. The averages of the three counties in each sector are fairly consistent with the New Mexico percentage rates in those sectors.

The employment rate in the various industries for the Texas counties in the year 2000 is provided in Table 3-42. As in Lea County, each of the six Texas counties has a high percentage working in the agriculture and mining industry (24.1 percentage average). Texas only has 2.7% employed in that sector. These Texas counties also have 23% employed in the educational, health, and social services sector. Texas employs a significantly higher percentage in the professional and management sector and in the manufacturing sector than the counties in the region of influence.

3.10.2.3 Employment, Jobs, and Occupational Patterns for Lea County

Oil production and related services are the largest part of the site area economy. In 2008, the oil and natural gas industries were responsible for contributing \$2.938 billion to New Mexico. That is the equivalent of paying into the State coffers \$8.05 million each and every day. That amount does not include the \$1.5 million New Mexico producers send to the federal government on a daily basis (IPANM, 2009). The Permian Basin including Lea and Eddy Counties in New Mexico and Gaines and Andrews Counties in Texas produces oil and natural gas from approximately 35,500 wells. It is estimated that there are 41 trillion cubic feet of natural gas and 1.3 billion barrels of oil lying undiscovered in the Permian Basin Province (EDCLC, 2009a). About 21% of jobs in Lea County, New Mexico involve mining (oil production), as compared to approximately 4% for New Mexico. However, the mining and extraction industry is highly volatile and the trend is similar to that of a roller coaster, as seen in Figure 3-77.

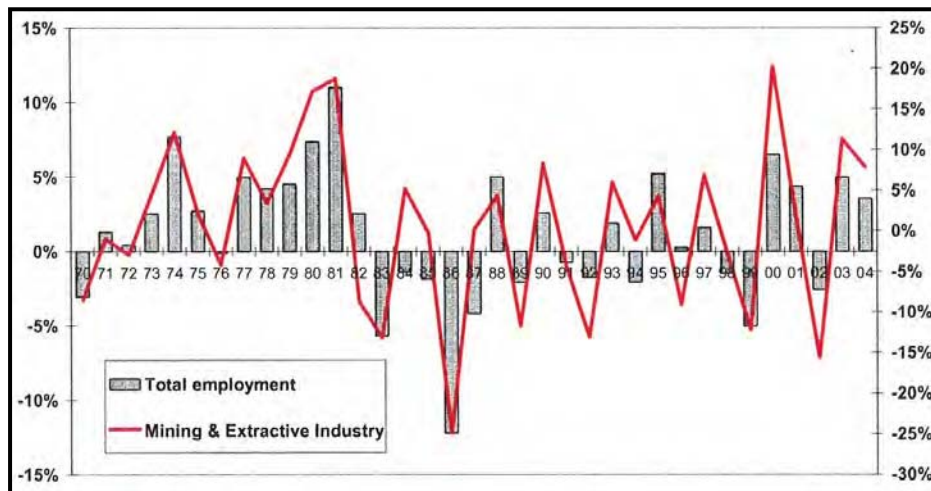

EDC, 2009

Figure 3- 77 Lea County Total Employment versus Employment in the Mining and Extraction Industries, 1969 to 2004

Table 3- 41 Employment in the Various Industries in New Mexico in Year 2000

Industry	Chaves County		Eddy County		Lea County		Total		New Mexico	
	No.	%	No.	%	No.	%	No.	%	No.	%
Agriculture, Forestry, Fishing And Mining	2,275	9.9	2,941	14.3	4,188	20.7	9,404	14.7	30,529	4.0%
Construction	1,575	6.8	1,413	6.9	1,268	6.3	4,256	6.7	60,602	7.9%
Manufacturing	2,226	9.7	1,279	6.2	715	3.5	4,220	6.7	49,728	6.5%
Wholesale Trade	700	3.0	515	2.5	658	3.2	1,873	2.9	20,747	14.9%
Retail Trade	2,938	12.8	2,753	13.4	2,418	11.9	9,982	15.6	92,766	
Transportation and Utilities	1,216	5.3	1,090	5.3	1,347	6.7	3,653	5.8	35,710	4.7%
Information	408	1.8	348	1.7	227	1.1	983	1.5	18,614	2.4%
Finance, Insurance, and Real Estate	1,154	5.0	873	4.2	642	3.2	2,669	4.2	41,649	5.5%
Professional, Mgt., Scientific, Admin., And Waste Mgt.	1,449	6.3	1,538	7.5	918	4.5	3,905	6.1	71,715	9.4%
Educational, Health, and Social Services	4,891	21.2	3,720	18.1	4,173	20.6	12,784	20.0	165,897	21.7%
Arts, Recreation, Entertainment, etc	1,899	8.2	1,619	7.9	1,327	6.6	4,845	7.6	747,89	9.8%
Other Services	1,214	5.3	1,408	6.8	1,343	6.6	3,965	6.2	38,988	5.1%
Public Administration	1,083	4.7	1,094	5.3	1,030	5.1	3,207	5.0	61,382	8.0%

Sources: USCB, 2000

Table 3- 42 Employment in the Various Industries in Texas in Year 2000

Industry	Andrews County (%)	Cochran County (%)	Gaines County (%)	Loving County (%)	Winkler County (%)	Yoakum County (%)	Total		Texas (%)
							Number	(%)	
Agriculture, Forestry, Fishing And Mining	21.0	27.1	25.0	28.6	18.7	34.9	4,280	24.1	2.7
Construction	5.1	2.2	7.3	7.1	7.1	3.3	961	5.5	8.1
Manufacturing	8.6	2.8	5.3	-	3.3	4.3	966	5.6	11.8
Wholesale Trade	2.5	2.1	4.6	-	2.3	2.4	533	3.1	3.9
Retail Trade	11.4	11.9	9.9	-	7.9	9.4	1,546	8.9	12.0
Transportation and Utilities	4.1	7.4	7.4	16.7	10.8	4.1	1,261	7.3	5.8
Information	1.8	0.4	1.3	-	0.4	0.3	292	1.7	3.1
Finance, Insurance, and Real Estate	3.5	1.1	3.7	-	3.2	3.1	565	3.3	6.8
Professional, Mgt., Scientific, Admin., And Waste Mgt.	4.6	2.1	1.5	-	2.9	2.1	479	2.8	9.5
Educational, Health, and Social Services	24.6	27.1	20.2	7.1	27.2	20.2	3,987	23.0	19.3
Arts, Entertainment, Recreation, etc	5.2	4.0	4.7	9.5	5.4	5.9	884	5.1	7.3
Other Services	4.5	5.3	6.6	-	4.6	4.8	909	5.2	5.2
Public Administration	3.2	6.4	2.7	31.0	6.2	5.2	717	4.1	4.5

Table 3-43 provides data on the recent performance of employment by sector for Lea County. Between 2001 and 2006, private sector employment in Lea County grew at a compound annual rate of 3.6%, with growth accelerated to 6.2% in 2006, when the net increase in private sector wage and salary employment approached 1400. The mining sector dominated, as it has since 2003, accounting for 849 jobs (15.8%), followed by transportation and warehousing (153 or a 45.1% increase). Wholesale accounted for an additional 162 jobs (a 17.4% increase in 2006). Manufacturing and Construction also had good increases in 2006 with 45.1% and 4.6%, respectively. Many of the job gains outside the mining sector are related to oil and gas, so the energy boom has been driving the economy as well as contributing to labor shortages throughout the region. Sectors losing jobs included administrative and waste management services (8.0%), real estate, rental and leasing (-9.1%), and retail trade with a 1.1% loss (BBER, 2007b).

Table 3- 43 Lea County Wage and Salary Employment by Sector, 2001-2006

Industry	Annual Average Employment						Average Growth (%)	
	2001	2002	2003	2004	2005	2006	2001-2006	2006
Agric, Forestry, Fishing & Hunting	385	452	463	380	417	402	0.9	-3.6
Mining	4,802	3,949	4,627	4,605	5,387	6,236	5.4	15.8
Utilities	246	243	232	235	242	242	-0.3	0.0
Construction	1,672	1,585	1,505	1,655	1,687	1,765	1.1	4.6
Manufacturing	369	328	361	336	339	492	6.0	45.1
Wholesale Trade	1,070	1,013	930	880	930	1,092	0.4	17.4
Retail Trade	2,731	2,552	2,466	2,681	2,719	2,690	-0.3	-1.1
Transportation and Warehousing	811	746	757	836	915	1150	7.2	25.7
Information	227	222	224	223	246	261	2.9	6.1
Finance and Insurance	540	578	607	623	644	649	3.8	0.8
Real Estate & Rental and Leasing	286	334	368	377	406	369	5.3	-9.1
Professional and Technical Services	276	320	358	391	373	435	9.5	16.6
Mgt of Companies and Enterprises	103	64	69	76	*	83	-4.3	*
Administration & Waste Services	1,072	1,199	950	1,407	1,457	1,340	4.6	-8.0
Health Care & Social Services	2,501	2,803	2,964	2833	2,826	2,843	2.6	0.6
Arts, Entertainment & Recreation	*	100	113	158	*	*	*	*
Accommodation & Food Services	1,477	1,416	1,566	1,708	1,833	1,888	5.0	3.0
Other Services	677	752	797	826	871	856	4.8	-1.7
Total Private Sector	19,555	18,885	19,209	20,460	21,935	23,297	3.6	6.2
Public Administration	3,507	3,360	3,361	3,391	3,384	3,390	-0.7	0.2
Grand Total	23,062	22,245	22,570	23,851	25,319	26,687	3.0	5.4

*Non-Disclosure of data due to Confidentiality
Source: BBER, 2007b

Lea County generally has fewer managerial and professional positions than New Mexico (Table 3-41), and instead has more blue-collar positions such as construction, production, transportation, and material moving, which is a reflection of the rural nature of the area and the presence of the petroleum industry (DOC, 2002). The percentage of the labor force in professional, scientific, and management-related occupations in these counties is about half of the labor force for New Mexico and Texas (DOC, 2002). According to the New Mexico Department of Labor, there will be an increase of 1,185 jobs for Hobbs by 2014. See Section 4.10.2.1, “Jobs, Income, and Population” for a breakdown of the industries impacted by this increase of jobs.

3.10.2.4 Income

Table 3-44, “Income Levels for the Nine-County Region in Census Year 2000,” provides the median household incomes and per capita incomes of selected groups. Generally, the counties in the region of influence had a lower median household income than their respective states, except for Loving County which is the lowest populated county in the U.S. The same is true for the per capita income for the counties in the region except for Loving County. Eddy County has the highest median and per capita income in the three New Mexico counties. The white per capita income for the three New Mexico counties is comparable to the state average, while the five Texas counties have significantly lower per capita incomes than the state. The Hispanic or Latino per capita income for all the counties is significantly less than the corresponding state averages.

Table 3- 44 Income Levels for the Nine-County Region in Census Year 2000

County	Median Household Income ¹ (\$)	Per Capita Income ² (\$)	White Per Capita Income ³ (\$)	Hispanic or Latino Per Capita Income ⁴ (\$)
New Mexico				
Chaves County	28,513	14,990	17,377	8,825
Eddy County	31,998	15,823	17,304	10,165
Lea County	29,799	14,184	16,778	8,667
New Mexico	34,133	17,261	17,261	12,045
Texas				
Andrews County	34,036	15,916	18,119	9,016
Cochran County	27,525	13,125	16,078	7,810
Gaines County	30,432	13,088	14,271	7,979
Loving County	40,000	24,083	28,249	4,983
Winkler County	30,591	13,725	15,635	7,771
Yoakum County	32,672	14,504	16,967	7,439
Texas	39,927	19,617	22,282	10,770

¹ U.S Median Household Income; \$41,994

² U.S Per Capita Income; \$21,587

³ U.S White Per Capita Income; \$23,918

⁴ U.S Hispanic or Latino Per Capita Income; \$12,111

Sources: U.S. Census Bureau, 2002; ePodunk

Specifically, the per capita income in Lea County was only 82.2% of the state average. Per capita income in Lea County, New Mexico was \$14,184, as compared to the respective state value of \$17,261. Similarly, the median household income in the county was also below the state average of \$34,133 at 87.3% (DOC, 2002). The county per capita individual poverty level of 21.1% is higher than the state level of 18.4% (DOC, 2002). The state household poverty level of 14.5% was below that of Lea County, New Mexico (17.3%).

3.10.2.5 Tax Structure

New Mexico's property tax rate is perennially ranked among the three lowest in the nation, with any change requiring an amendment to the state constitution. The property assessment rate is uniform, statewide, at a rate of 1/3 of the value (except oil and gas properties), which means that the net taxable value is one third of the assessed value minus allowable exemptions. The maximum operating levy that may be imposed by a county in New Mexico is 11.85 mils, while the maximum for a municipality is 7.65 mils. The tax applied is a composite of state, county, municipal, school district and other special district levies. Properties outside city limits are taxed at lower rates. Major facilities may be assessed by the New Mexico State Taxation and Revenue Department instead of by the county. The Lea County, New Mexico tax rate for non-residential property outside the city limits of Hobbs is 24.9 mils per \$1,000 of net taxable value of a property (LCNM, 2009). New Mexico communities can abate property taxes on a plant location or expansion for a maximum of 30 years, (usually 20 years in most communities), controlled by the community.

The state also has a Gross Receipts Tax paid by product producers. This tax is imposed on businesses in New Mexico, but in almost every case it is passed to the consumer. In that way, the gross receipts tax resembles a sales tax. The gross receipts tax rate for the Hobbs area, outside the city limits is 5.00% (BBER, 2007b). Certain deductions may apply to this tax for plant equipment.

The gross receipts tax provides over two-thirds of New Mexico municipality general fund revenues and is of growing importance to county governments. Municipalities have the authority to impose up to 1.25 cents in quarter and eighth cent increments for a municipal gross receipts tax, with an additional quarter cent of authority to impose increments of municipal infrastructure tax. They also can impose a one eighth cent environmental gross receipts tax. Municipalities also all receive a 1.225% distribution of State-shared receipts based on state revenues from activity within the municipality (BBER, 2007b).

Table 3-45 provides five years of data on gross receipts tax distributions for Lea County and the municipalities in the county. The annual growth rates are presented, the compound annual growth between 2002 and 2006 and the growth between 2005 and 2006. The revenue growth is affected by changes in the local option taxes and by changes in the tax base. The recent strong growth in taxable receipts is related to oil and gas activity (BBER, 2007b).

Table 3- 45 Gross Receipts Tax Distributions for Lea County

Entity	FY 2002	FY 2003	FY 2004	FY 2005	FY 2006	FY Annual Growth (%)	
						2002-2006	2005-2006
County Govt.	3,477,204	3,225,683	3,748,633	5,514,270	6,607,446	17.4	19.8
Eunice	1,134,186	1,168,945	1,375,416	1,885,204	2,314,250	19.5	22.8
Hobbs	19,905,160	19,235,346	22,252,548	28,751,528	34,154,693	14.5	18.6
Jal	656,789	648,589	520,476	688,525	737,064	2.9	7.0
Lovington	2,925,999	2,951,055	3,570,609	4,743,855	4,645,842	12.3	-2.1
Tatum	279,059	279,289	300,446	470,889	411,348	10.2	-12.6

Source: BBER, 2007b

Counties have more limited general authority to impose a county gross receipts tax and they do not receive a state-shared distribution. However, counties have numerous options to impose taxes for other

purposes. Some of these taxes, e.g., fire protection, county environmental gross receipts tax, may only be imposed on residents of the unincorporated area. Some, like that for jails and hospital and health care, reflect county responsibilities and are imposed county-wide.

Property taxes provide a majority of revenue for local services in Texas. Property taxes are based on the most current year's market value. Any county, municipality, school district or college district may levy property taxes. Texas local governments make much more use of the property tax than is true of their New Mexico counterparts. According to the Tax Foundation, property taxes per capita in Texas were \$1,405, versus \$495 in New Mexico in 2006. Texas ranked 13th among the states, while New Mexico ranked 48th (Tax Foundation, 2006a). By contrast, state and local gross receipts taxes per capita in Texas in FY 06 were \$974, giving the state a ranking of 18th, while per capita gross receipts taxes in New Mexico were \$1,280, putting the state in 8th place (Tax Foundation, 2006b). While not a local government revenue source, New Mexico's personal income tax per capita in 2006 ranked it 37th among the states. Texas has no personal income tax (Tax Foundation, 2006c).

3.10.3 Community Characteristics

3.10.3.1 Housing

Housing in Lea County, New Mexico, varies from the state in general, reflecting the rural nature of the area. Table 3-46 provides the housing statistics for the region of influence around the IIFP site. The number of rooms per housing unit is similar to state average (5.1 rooms versus 5.0 for the state). The

Table 3- 46 Housing in the Region of Influence around the IIFP Site for Census Year 2000

Area	Total Housing Units	Occupied Units	Land Area (mi ²)	Housing Density (units/mi ²)	Median Value (Year 2000 \$)
New Mexico					
Chaves County	25,647	22,561	6,075	4.2	61,000
Eddy County	22,249	19,379	4,198	5.3	64,200
Lea County	23,405	19,699	4,393	5.3	50,100
Total (3 counties)	71,301	61,639	14,666	4.9	58,433 ¹
New Mexico Total	780,579	677,971	121,356	6.4	108,100
Texas					
Andrews County	5,400	4,601	1,501	3.6	42,500
Cochran County	1,587	1,309	775	2.0	25,700
Gaines County	5,410	4,681	1,503	3.6	48,000
Loving County	70	31	673	0.1	Not Specified
Winkler County	3,214	2,584	841	3.8	29,600
Yoakum County	2,974	2,469	800	3.7	40,400
Total (6 counties)	18,655	15,675	6,093	3.1	37,240 ¹
Texas Total	8,157,575	7,393,354	261,797	31.2	82,500
Region of Influence					
Total	89,956	77,314	20,759	4.3	45,188 ¹

¹Average computed from the number of counties involved.
Source: USCB, 2002

density of housing units for Lea County is also comparable to the state density (5.3 versus 6.4 units/mi²). However, the value of housing is considerably different for the state; the median value of the housing unit

is over twice the value of the Lea County housing unit. Chaves County has the lowest density of the 3 New Mexico counties at 4.2 units/mi² compared to the 4.9 units/mi² for the 3 counties.

The housing density for the Texas counties in the region of influence is significant less than the New Mexico county housing densities. The housing densities for the 6 counties are only 10% of those for the state of Texas. Additionally, the housing density for Texas is almost 5 times greater than the housing density for New Mexico. Interestingly, the least populated county in the U.S. has a housing density of only 0.1 units/mi², only 0.03% of the state density. Also of interest is that the average value of the housing unit in the Texas counties is only 45% of the median value of the Texas housing unit.

Table 3-47 shows the mix of housing types in Lea County. The Census classifies housing units into single detached, two or more units, and mobile homes. In 2000, three-quarters of all Lea County were single family dwellings. Less than 10% were multi-unit structures and one in six was a mobile home (BBER, 2007a).

Table 3- 47 Lea County Housing Units by Type Geographical Area for Census Year 2000

Study Area	Number of Housing Units			
	Single Detached	Two or more Units	Mobile Homes	Total
City of Hobbs	9,493	1,570	1,593	12,656
Unincorporated Hobbs	1,449	51	1,079	2,579
Hobbs Area	10,942	1621	2,672	15,235
Eunice Area	954	57	240	1,251
Jal Area	941	12	90	1,043
Lovington Area	3,222	243	558	4,023
Tatum Area	1,320	25	508	1,853
Lea County	17,379	1,958	4,068	23,405

Source: Census 2000; BBER, 2007a

As seen in Table 3-46, the median cost of a home in Lea County, New Mexico of \$50,100. The cost of a home in Lea County is about one-half or less of the median values for the state. In Andrews and Gaines counties, the housing unit density is 1.4 units/km² (3.6 units/mi²). The Texas State average housing density is 12 units/km² (31.2 units/mi²), and the median cost of a home is \$82,500. The variation in housing between the counties and the State averages is reflective of the rural nature of the county areas. The percentage of vacant housing units is 15.8% for Lea County which compares to the state vacancy rate of 13.1%. See Table 3-48, “Vacant Housing Units in Lea County, By Area.”

Figure 3-78 shows that Tatum had the highest proportion (65.1%) of vacant units that were classified as “Other,” followed by Eunice (61.7%). Tatum also had the highest proportion (8%) of vacant housing units for seasonal or occasional use. Hobbs, on the other hand, had the largest proportion (41.4%) of rental vacancies (BBER, 2007a). The percentage of vacant housing units is 14.8% for Andrews County and 13.5% for Gaines County compared with 9.4% rate for the state of Texas (DOC, 2002).

Table 3- 48 Vacant Housing Units in Lea County, by Area in Census Year 2000

Area	Vacancy Rate	Total Vacant Units
City of Hobbs	16.2	2,054
Unincorporated Hobbs	9.8	253
Hobbs Area	15.0	2,307
Eunice Area	23.7	188
Jal Area	14.2	247
Lovington Area	13.7	563
Tatum Area	21.6	401
Lea County	15.8	3,706

Source: BBER, 2007a

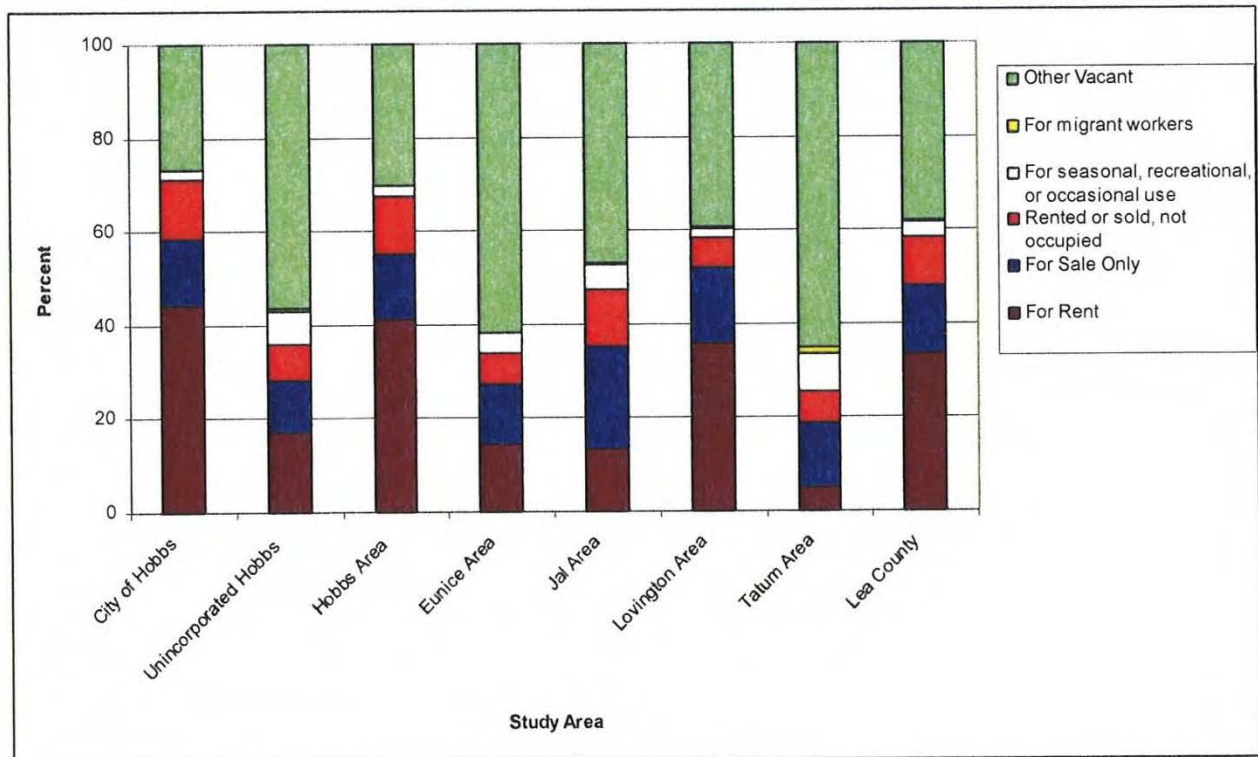

Source: BBER, 2007a

Figure 3- 78 Vacant Housing Units in Lea County by Type and Area in Census Year 2000

3.10.3.2 Education in the Region of Influence

Table 3-49 summarizes the school enrollment data for the region of influence. The table lists the percentages of school enrollment for the Lea County, New Mexico, and for Gaines County and Andrews County in Texas as well as their respective states. In general, the population in Lea County, New Mexico, has less advanced education than the general population in New Mexico.

Table 3-50 provides the education attainment for the nine county region of influence based on the latest census figures. The table lists the percent ages of educational attainment for the population 25 years and

Table 3- 49 Education Characteristics in the Region of Influence for Census Year 2000

Area	School Enrollment	Grades <8 (%)	Grades 9-12 (%)	College (%)
New Mexico				
Chaves County	18,132	46.2	25.2	18.1
Eddy County	14,292	49.6	25.5	13.6
Lea County	16,534	48.4	25.5	16.7
New Mexico	533,786	44.7	22.3	22.5
Texas				
Andrews County	3,864	51.0	30.3	8.6
Cochran County	1,081	51.9	32.1	7.9
Gaines County	4,369	57.8	25.1	6.1
Loving County	27	33.3	25.9	40.7
Winkler County	1,938	51.0	30.9	7.0
Yoakum County	2,286	47.6	32.7	8.0
Texas	5,948,260	45.5	21.9	20.2

Source: USCB, 2002

Table 3- 50 Education Attainment in the Region of Influence for Census Year 2000

Area	Population 25 Years and Over	High School Graduate or Higher (%)	Bachelor's Degree or Higher (%)
New Mexico			
Chaves County	37,811	72.6	16.2
Eddy County	32,572	75.0	13.5
Lea County	33,291	67.1	11.6
New Mexico	1,134,801	78.9	23.5
Texas			
Andrews County	7,815	68.0	12.4
Cochran County	2,236	62.7	10.2
Gaines County	8,006	56.2	10.5
Loving County	51	86.3	5.9
Winkler County	4,380	60.3	10.5
Yoakum County	4,322	59.4	10.2
Texas	12,790,893	75.7	23.2

Source: USCB, 2002

over in those same areas. The state population with either a bachelor's, graduate or professional degree is about double the corresponding percentage in Lea County, New Mexico (DOC, 2002).

3.10.3.3 Education in the Lea County

Table 3-51 and Figure 3-79 provides detailed breakdown of the level of educational attainment in Lea County, specifically. One in three adults in Lea County did not have a high school diploma in 2000. The elderly (65 years old and over) had the lowest educational attainment. Two in five elderly did not complete their high school education. The young adults (18 to 24 years old) had the second lowest educational attainment. Approximately 37% of them had less than a high school diploma. The population

Table 3- 51 Highest Educational Attainment of Population 18 Years and Older in Lea County

Educational Attainment/Aage	Population 18 Year and Older		
	Males	Females	Both Sexes
18 to 24 Years:	2,970	2,521	5,491
Less than high School	1,234	810	2,044
High School Graduate	1,612	1,483	3,095
College Degree	124	228	352
25 to 34 years:	3,390	3,459	6,849
Less than high School	1,131	1,022	2,153
High School Graduate	1,820	1,672	3,492
College Degree	439	765	1,204
35 to 44 Years:	4,319	4,070	8,389
Less than high School	1,408	1,215	2,623
High School Graduate	2,202	2,028	4,230
College Degree	709	827	1,536
45 to 64 Years:	5,513	5,587	11,100
Less than high School	1,651	1,676	3,327
High School Graduate	2,768	2,776	5,544
College Degree	1,094	1,135	2,229
65 Years and Older:	2,985	3,968	6,953
Less than high School	1,144	1,711	2,855
High School Graduate	1,451	1,802	3,253
College Degree	390	455	845
All Ages:	19,177	19,605	38,782
Less than high School	6,568	6,434	13,002
High School Graduate	9,853	9,762	19,614
College Degree	2,756	3,410	6,166

Source: BBER, 2007a)

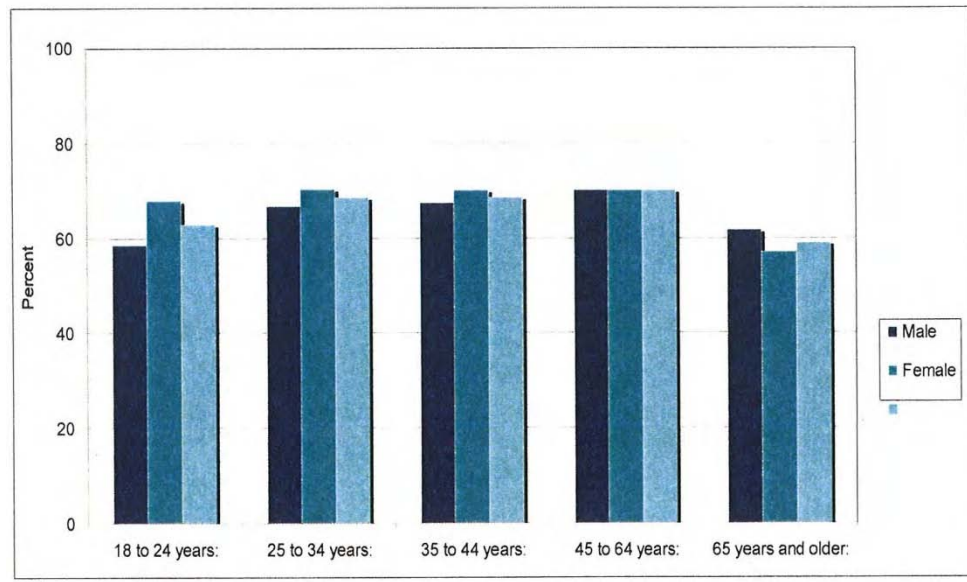

Figure 3- 79 Population 18 Years and Older with a High School Diploma or Higher

25 to 64 years old had the highest educational attainment, close to 70% of this population reported a high school diploma or a college degree in 2000 (BBER, 2007a).

Among women, high educational attainment was inversely related to age. Women in the 25 to 34 age group (22%) had the highest proportion of college graduates while those in the 65 years and older category had the lowest. Among men, college education was directly correlated with age. The proportion of college educated men gradually increased from 4% in the 18 to 24 year old category to a high of 20% among the 45 to 64 year olds, after which the proportion dropped to 13% in the oldest category (BBER, 2007a).

Table 3-52 shows that Lea County has a total of 20 elementary schools, 9 middle schools, and 7 high schools. Hobbs Municipal Schools has the most number of schools with 12 elementary, three middle schools, and two high schools. Two private schools are also located in Hobbs. Also, there are three colleges, including a community vocational junior college (BBER, 2007b).

Table 3- 52 Public School Districts in Lea County

School District	Elementary School	Middle High School	High School	Total
Eunice Municipal Schools	1	1	1	3
Hobbs Municipal Schools	12	3	2	17
Jal Public Schools	1	1	1	3
Lovington Public Schools	5	3	2	10
Tatum Municipal Schools	1	1	1	3
Lea County Total	20	9	7	36

Source: BBER, 2007a

3.10.3.4 Health Care, Public Safety, and Transportation Services

Health Care

There are two hospitals in Lea County, New Mexico. The Lea Regional Medical Center is located in Hobbs, New Mexico. Lea Regional Medical Center is a 250-bed hospital that can handle acute and stable chronic care patients. In Lovington, New Mexico, Covenant Medical Systems manages Nor-Lea Hospital, a full-service, 27-bed facility. A health care clinic at Eunice, New Mexico, was constructed and opened for patients in February 2009. The clinic was expanded in 2008 with more exam rooms, equipment, storage space, and offices. There are fourteen nursing homes or senior living facilities in Hobbs, New Mexico (EDCLC, 2009c).

Public Safety

Fire support service for the Hobbs area is provided by the Hobbs Fire and Rescue, located approximately 22.5 km (14 mi) from the proposed site. It is staffed by a full-time Fire Chief with 72 employees and a class rating of 4. The Hobbs Fire Department has 19 paramedics and 43 EMT-1, and 2 SWAT Medics serving with the Hobbs Fire Department. The Hobbs Fire Department inventory of EMS units has increased to seven. The Hobbs Fire Department now averages 425 EMS responses each month (5100 runs/year (EDCLC, 2009c).

If additional fire equipment is needed, or if the Hobbs Fire and Rescue is unavailable, the Central Dispatch will call the Eunice, NM or Andrews, TX Fire Departments. In instances where radioactive or

hazardous materials are involved, knowledgeable members of the facility Emergency Response Organization (ERO) will provide information and assistance to the responding off-site personnel.

Based on a review of the IIFP rev 0, Emergency Plan by the local emergency services organizations and their responses, it is expected that mutual aid agreements will be obtained with the Lea County emergency service organizations. If emergency services personnel in Lea County are not available at a particular locale, the mutual aid agreements are activated and the Hobbs Central Dispatch will contact the appropriate agencies for the services requested at the site.

The Hobbs Police Department, with five full-time officers, provides local law enforcement. The Lea County Sheriff's Department also maintains a substation in the community of Hobbs. If additional resources are needed, officers from mutual aid communities within Lea County, New Mexico can provide an additional level of response. The New Mexico State Police provides a third level of response.

Transportation

The main highway in the county is U.S. Highways 62/180, which runs east-west through Hobbs. It is designated as a primary feeder to the interstate highway system.

The nearest active rail transportation is a short-line carrier, the Texas-New Mexico Railroad accessible in Hobbs, New Mexico.

Several airports are located within the Lea County. The only commercial carrier airport facility is Lea County Regional Airport west of Hobbs, New Mexico, about 12.9 km (8 mi) from the Proposed IIFP Facility. Other airports include the Hobbs Industrial Airpark (Humble City), the Eunice Airport, the Gaines County Airport in Seminole, TX, the Jal Airport, and the Lovington County Airport. Privately owned planes are the primary users of these airports. There are no control towers and no commercial air carrier flights at these airports.

3.11 Public and Occupational Health

Routine operations at the IIFP facility create the potential for radiation exposure to plant workers, members of the public, and the environment. Workers at the IIFP plant are subject to higher potential radiation exposures than members of the public because they are involved directly with handling depleted UF₆ cylinders; processes handling DUF₆, DUF₄, and the depleted uranium oxides; storage of DUF₄; and decontamination of containers and equipment. In addition to the radiological hazards associated with uranium, workers may be potentially exposed to the chemical hazards associated with uranium. However, workers at the IIFP facility are protected by the implementation of a combination of a Radiation Protection Program, a Chemical Safety Program, and a Health and Safety Program. The Radiation Protection Program and the Chemical Safety Program complies with applicable NRC requirements contained in 10 CFR 20 (CFR, 2009a), Subpart B, and the Health & Safety Program at the IIFP plant complies with applicable OSHA requirements contained in 29 CFR 1910 (CFR, 2009g).

Members of the general public also may be subject to potential radiation or chemical exposure in the unlikely event of an accident at the IIFP plant. Public exposure to plant-related uranium may occur as the result of gaseous and liquid effluent discharges; transportation of DUF₆; depleted uranium oxides; and storage of DUF₆, DUF₄. In each case, the amount of exposure incurred by the general public is expected to be very low. Engineered effluent controls, effluent sampling, and administrative limits as described in Section 6.1.1, Effluent Monitoring Program, are in place to assure that any impacts on the health and safety of the public resulting from routine plant operations are maintained as low as reasonably

achievable (ALARA). The effectiveness of the effluent controls will be confirmed through implementation of the Radiological Environmental Monitoring Program (described in ER Section 6.1.2, “Radiological Environmental Monitoring Program”). Radiological impacts to the public are discussed in ER Section 4.12, “Public and Occupational Health Impacts.”

3.11.1 Major Sources and Levels of Background Radiation

The sources of radiation at the IIFP site historically have been, and still are, associated with natural background radiation sources and residual man-made radioactivity from fallout associated with the atmospheric testing of nuclear weapons in the western United States and overseas in the 1950s and 1960s. Naturally-occurring radioactivity includes primordial radionuclides (nuclides that existed or were created during the formation of the earth and have a sufficiently long half-life to be detected today) and their progeny, as well as nuclides that are continually produced by natural processes other than the decay of the primordial nuclides. These primordial nuclides are ubiquitous in nature, and are responsible for a large fraction of radiation exposure referred to as background exposure. The majority of primordial radionuclides are isotopes of the heavy elements and belong to the three radioactive series headed by ^{238}U (uranium series), ^{235}U (actinium series), and ^{232}Th (thorium series) (NCRP, 1987a). Alpha, beta, and gamma radiation is emitted from nuclides in these series. The relationship among the nuclides in a particular series is such that, in the absence of chemical or physical separation, the members of the series attain a state of radioactive equilibrium, wherein the decay rate of each nuclide is essentially equal to that of the nuclide that heads the series. The nuclides in each series decay eventually to a stable nuclide. For example, the decay process of the uranium series leads to a stable isotope of lead. There are also primordial radionuclides, specifically ^{40}K and ^{37}Rb , which decay directly to stable elements without going through a series of decay sequences. The primordial series of radionuclides represents a significant component of background radiation exposure to the public (NCRP, 1987a). Cosmogenic radionuclides make up another class of naturally occurring nuclides. Cosmogenic radionuclides are produced in the earth's crust by cosmic-ray bombardment, but are much less important as radiation sources (NCRP, 1987a).

The naturally occurring forms of radioactive elements incorporated into the earth during its formation that is still present are referred to as “terrestrial radionuclides.” The most significant terrestrial radionuclides include the uranium and thorium decay series, potassium-40 and rubidium-87. Virtually all material found in nature contain some concentration of terrestrial radionuclides. Table 3-53 lists the average and typical ranges of concentrations of terrestrial radionuclides. Although the ranges in the table are typical, larger variations exist in certain areas (NRC, 2009).

Naturally-occurring radioactivity in soil or rock near the earth's surface belonging to the primordial series represents a significant component of background radiation exposure to the public (NCRP, 1987a). The radionuclides of primary interest are ^{40}K and the radioactive decay chains of ^{238}U and ^{232}Th . These nuclides are widely distributed in rock and soil. Soil radioactivity is largely that of the rock from which it was derived. The original concentrations may have been diminished by leaching and dilution by water and organic material added to the soil, or may have been augmented by adsorption and precipitation of nuclides from incoming water. Nevertheless, a soil layer about 0.25 m (0.8 ft) thick furnishes most of the external radiation from the ground (NCRP, 1987a). In general, typical soil and rock contents of these radionuclides indicate that the ^{232}Th series and ^{40}K each contributes an average of about 150 to 250 pGy per year (15 to 25 mrad per year) to the total absorbed dose rate in air for typical situations, while the uranium series contribute about half as much (NCRP, 1987a).

The public exposure from naturally-occurring radioactivity in soil varies with location. In the U.S., background radiation exposures in the Southwest and Pacific areas are generally higher than those in

Table 3- 53 Typical Average Concentration Ranges of Terrestrial Radionuclides

Material	Radium-226 (Bq/kg) ^a	Uranium-238 (Bq/kg) ^a	Thorium-232 (Bq/kg) ^a	Potassium-40 (Bq/kg) ^a
Soil, U.S.	40 (8-160) ^b	35 (4-140) ^b	35 (4-130) ^b	370 (100-700) ^b
Phosphate Fertilizer	200 ^c - 100,000 ^d	200-1,500 ^b	20 ^b	--
Concrete	(19-89) ^e	(19-89) ^f	(15-120) ^f	(260-1,100) ^f
Concrete Block	(41-780) ^e	(41-780) ^f	(37-81) ^f	(290-1,100) ^f
Brick	(4-180) ^e	(4-180) ^f	(1-140) ^f	(7-1,200) ^f
Coal Tar	(100-300) ^e	(100-300) ^b	--	--
Fly Ash-Bottom Ash	200 ^e	200 ^b	200 ^b	--
Coal, U.S.	--	18 (1-540) ^g	21 (2-320) ^g	52 (1-710) ^g
Tile	--	(550-810) ^h	650 ^h	--
Porcelain, Glazed	--	(180-37,000) ^{h, i}		--
Ceramic, Glazed ^b	(79-1,200) ^{h, i}			

^a To convert Bq/kg to pCi/g, multiply by 0.027.

^b UNSCEAR, Sources and Effects of Ionizing Radiation (UNSCEAR 2000).

^c U.S. Environmental Protection Agency (EPA), 2000. *Evaluation of EPA's Guidelines for Technologically Enhanced Naturally Occurring Radioactive Materials (TENORM)*.

^d National Academy of Sciences (NAS). 1999. *Evaluation of Guidelines for Technologically Enhanced Naturally Occurring Radioactive Materials (TENORM)*, Committee on Evaluation of EPA Guidelines for Exposure to Naturally Occurring Radioactive Materials Board on Radiation Effects Research Commission on Life Sciences National Research Council, National Academy Press, p. 72.

^e Ra-226 is assumed to be in secular equilibrium with U-238

^f Eicholz G.G., Clarke F.J., and Kahn, B., 1980. (Eicholz, 1980) *Radiation Exposure From Building Materials*, in "Natural Radiation Environment III," U.S. Department of Energy CONF-780422.

^g Beck H.L., Gogolak C.V., Miller K.M., and Lowder W.M., 1980 (Beck, 1980). *Perturbations on the Natural Radiation Environment Due to the Utilization of Coal as an Energy Source*, in "Natural Radiation Environment III," U.S. Department of Energy CONF-780422.

^h Hobbs T.G., 2000. (Hobbs, 2000) *Radioactivity Measurements on Glazed Ceramic Surfaces*, J. Res. Natl. Inst. Stand. Technol. **105**, 275-283.

ⁱ Values reported as total radioactivity without identification of specific radionuclides

much of the Eastern and Central regions. There is also a wide variation in annual background terrestrial radiation across the State of New Mexico. The North Central region (Albuquerque area) exhibits an average annual absorbed dose in air of about 0.75 mGy (75 mrad); while the southeastern corner of the State (Carlsbad area), which includes the IIFP site area in Lea County, measures annual average terrestrial absorbed dose of about 0.30 mGy (30 mrad) (NCRP, 1987a). Applying the same weighting factor, the annual average dose equivalent for the Albuquerque and Carlsbad areas are about 525 and 210 pSv (53 and 21 mrem), respectively. Some of the variation is linked to location, but factors such as moisture content of soil, the presence and amount of snow cover, the radon daughter concentration in the atmosphere, the degree of attenuation offered by housing structures, and the amount of radiation originating in construction materials may also account for variation (NCRP, 1987b).

Background radiation for the public also includes various sources of man-made radioactivity, such as fallout in the environment from weapons testing, and radiation exposures from medical treatments, x-rays, and some consumer products. All of these types of man-made sources contribute to the annual background radiation exposure received by members of the public. Of these, fallout from weapons testing should be included as an environmental radiation source for the IIFP site. The two nuclides of concern with regard to public exposure from weapons testing are ¹³⁷Cs and ⁹⁰Sr due to their relative abundance, long half lives (30.2 and 29.1 years, respectively) and their ability to be incorporated into human exposure pathways, such as external direct dose and ingestion of foods. The average range of doses from weapons testing fallout to residents of New Mexico has been estimated as 1-3 mGy (100-300 mrad) (CDCP, 2001). Use of radiation in medicine and dentistry is also a major source of man-made background radiation exposure to the U.S. population. Although radiation exposures from medical treatments, X-rays, and

some consumer products are considered to be background exposures, they would not be incurred by the public at the IIFP facility. Nevertheless, as a point of reference, medical procedures contribute an average of 0.39 mSv (39 mrem) for diagnostic x-rays and nuclear medicine contributes an average of 0.14 mSv (14 mrem) to the annual average dose equivalent received by the U.S. population (NCRP, 1989). Exposures at these levels are approximately the same as the expected exposure in the southwest area of the country which includes the IIFP site from primordial radionuclides. Consumer products (e.g., television receivers, ceramic products, tobacco products) also contribute to annual background radiation exposure. The average annual dose equivalent from consumer products and other miscellaneous sources (e.g., x-ray machines at airports, building materials) can range from fractions of a microsievert (millirems) to several Sieverts (hundreds of rems) (NCRP, 1987b).

3.11.1.1 Current Radiation Sources

Workers at the IIFP facility are subject to higher potential exposures than members of the public because they are involved directly with handling depleted UF₆ cylinders; processes handling DUF₆, DUF₄, and the depleted uranium oxides; and storage of DUF₄. During routine operations, workers at the plant may potentially be exposed to direct radiation, airborne radioactivity, and limited surface contamination. These potential exposures include various types of radiation, including gamma, neutron, alpha, and beta. Activities primarily contributing to worker annual exposures include transporting cylinders, coupling and uncoupling containers, and other handling tasks. Office workers at the IIFP plant may be exposed to direct radiation from the plant operations mentioned above.

Since the IIFP site has not previously been developed for industrial or commercial purposes, there are no known past uses of the property that would have used man-made or enhanced concentrations of radioactive materials. Therefore, for members of the public, the only sources of radiation exposure currently present at the Proposed IIFP Site are associated with natural background radiation and residual radioactivity from weapons testing fallout.

3.11.1.2 Historical Exposure to Radioactive Materials

In the United States, individuals receive 360 mrem per year dose equivalent, on the average, from normal background radiation (NCRP, 1987). See Figure 3-80.

3.11.1.3 Summary of Health Effects

Health effects from radiation exposure became evident soon after the discovery of x-rays in 1895 and radium in 1898. Following World War II, many studies were initiated to investigate the effect of radiation on Japanese populations who survived the atomic bombing of Hiroshima and Nagasaki. The reports of the United Nations Scientific Committee on the Effects of Atomic Radiation (UNSCEAR) (UNSCEAR, 1986; UNSCEAR, 1988) and the National Academy of Sciences Committee of the Biological Effects of Ionizing Radiation (BEIR) (NAS, 1980; NAS, 1988) are comprehensive reviews of the Japanese data. In addition, numerous radiobiological studies have been conducted in animals (e.g., mouse, rat, hamster, dog), and in cells and tissue cultures. Extrapolations to humans from these experiments are problematic and despite the large amount of accumulated data, uncertainties still exist regarding the effects of radiation at low doses and low dose rates.

The most reliably estimated risks are those associated with relatively high doses (i.e., greater than 1 Gy (100 rad)) (NCRP, 1989). The radiation health community is in general agreement that risks at smaller doses are at least proportionally smaller (e.g., no more than 1/100 the risk at 1/100 the dose). It is likely that the risks may be considerably smaller (NCRP, 1980).

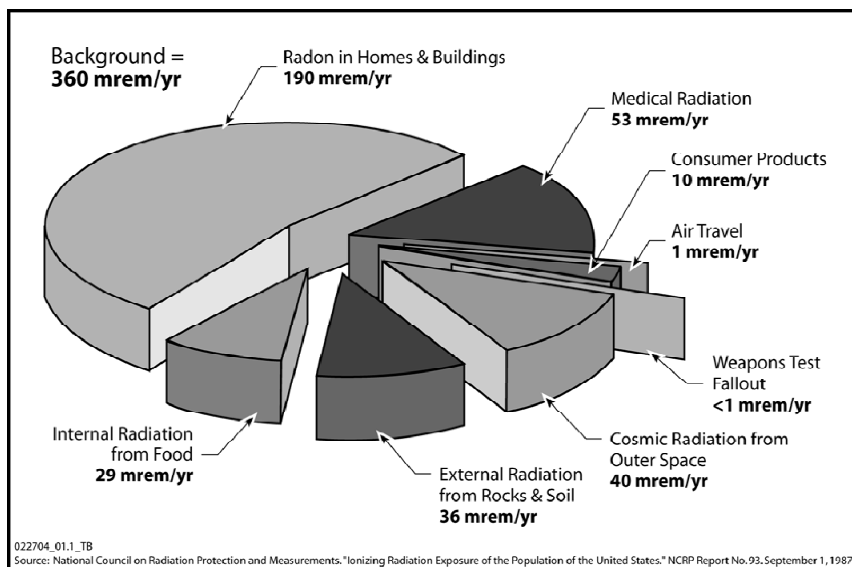

Figure 3- 80 Ionizing Radiation Exposure of the Population of the United States

Serious radiation-induced diseases fall into two categories: stochastic effects and non-stochastic effects. A stochastic effect is defined as one in which the probability of occurrence increases with increasing absorbed dose but the severity in affected individuals does not depend on the magnitude of the absorbed dose (NCRP, 1989). A stochastic effect is an all-or-none response as far as the individuals are concerned. Cancers such as solid malignant tumors, leukemia and genetic effects are regarded as the main stochastic effects to health from exposure to ionizing radiation at low-absorbed doses (NCRP, 1989). It is generally agreed among members of the scientific community that a radiation dose of 100 mGy (10 rads) increases the risk of developing cancer in a lifetime by about 1% (NCRP, 1989). In comparison, a non-stochastic effect of radiation exposure is defined as a somatic effect which increases in severity with increasing absorbed dose in affected individuals, owing to damage to increasing numbers of cells and tissues (NCRP, 1989). Examples of non-stochastic effects from radiation exposure are damage to the lens of the eye, nausea, epilation, diarrhea, and a decrease in sperm production in the male (NCRP, 1980; NCRP, 1989). These effects have been observed only following high-dose exposures, typically greater than 1 Gy (100 rads) to the whole body (NCRP, 1989). The potential doses to the public due to routine operations at the IIFP plant are presented in ER Section 4.12, "Public and Occupational Health." Impacts are several orders of magnitude below the natural background doses discussed here. For further information, NCRP Report No. 64 (NCRP, 1980) provides an overview of research results and data relating to biological effects from radiation exposures.

3.11.2 Major Sources and Levels of Chemical Exposure

The IIFP site has no history as an industrial site. Consequently, there are currently no known major sources of chemical exposure at the site that may impact the public. In ER Section 1.2, Table 1-1 identifies the inventories of major chemicals for the Phase 1 and Phase 2 facility. A written agreement has been obtained with the New Mexico Environment Department for limits on the maximum amount of uranium and other major chemical inventories at the IIFP facility. These maximum limits are included Table 1.1.

Section 3.6.2, Existing Levels of Air Pollution and Their Effects on Plant Operations, discusses the regional air quality for both Lea County, New Mexico and Andrews County, Texas for those parameters

or pollutants tracked under EPA requirements, including a listing of existing sources of criteria pollutants, such as volatile organic compounds (VOC). In general, ambient air quality in the region is characterized as very good and in compliance of EPA criteria for pollutants. ER Section 4.6, Air Quality Impacts, discusses expected IIFP emissions of criteria pollutants from house boilers that power the facility's heating system.

3.11.2.1 Occupational Injury Rates

Occupational injury rates at the IIFP facility are expected to be better than the industry average owing to the commitment that IIFP is making in a safe design basis for facilities and programs, the safety culture, and adherence to the ISMS program and procedures. IIFP senior management commitment to safety is evident by its safety experience at its Idaho Falls facility and the recognition it has received. Common occupational accidents at uranium plants similar to the proposed IIFP plant typically involve hand and finger injuries, tripping accidents, minor burns and impacts due to striking objects or falling objects. Table 3-54 shows incidence rates representative of the nonfatal occupational injuries from the construction and operation for Total Private Industry. This representative calculation is based on the Bureau of Labor Statistics of the U.S. Department of Labor (2007). The representative number of injuries would be that number for the Total Private Industry rate if the industry had an average of 200 workers during the construction of the facility for 18 months and 150 average workers during the operations of the facility.

Table 3- 54 Nonfatal Occupational Injuries Projected for Construction and Operations of the IIFP Facility

Case Type	Construction (18 months)		Operations (Yearly)	
	Incidence Rate ¹	Number	Incidence Rate ¹	Number
Total Recordable Cases (TRC)	4.2	12.6	4.2	6.3
Days Away from Work, Job Transfer, or Restriction Cases (DART)	2.1	6.3	2.1	3.15
Days Away From Work Cases (DAFW)	1.2	3.6	1.2	1.8
Days of Job Transfer or Restricted Only Cases (DJTR)	0.9		0.9	
Other Recordable Cases (ORC)	2.1	6.3	2.1	3.15
TRC by Employment Size	5.3	15.9	5.3	7.95

Source: Bureau of Labor Statistics, U.S. Department of Labor (BLS, 2008)

¹2007 Incidence Rate per 100 full-time workers for Total Private Industry

3.11.2.2 Public and Occupational Exposure Limits

The radiation exposure limits for the general public have been established by the NRC in 10 CFR 20 (CFR, 2009a) and by the EPA in 40 CFR 190 (CFR, 2009u). The NRC exposure limits place annual restrictions on the total dose equivalent exposure [1 mSv (100 mrem)], which includes external plus internal radiation exposures and dose equivalent rate [0.02 mSv (2 mrem)] in any 1 hour in unrestricted areas that are accessible by members of the public who are not employees, but who may be present during the year at the IIFP plant. Public exposure at off-site locations due to routine operations complies with these limits. Annual exposure to the public is maintained ALARA through effluent controls and monitoring (ER Section 6.1, “Radiological Monitoring”).

The NRC also places restrictions on radiation exposures incurred by employees at the IIFP facility. The NRC restricts the annual radiation exposure that an employee may receive to a total effective dose equivalent (TEDE) of 50 mSv (5 rem), which includes external and internal exposure. In addition, the NRC places restrictions of the dose equivalent to the lens of the eye [0.15 Sv (15 rem)], skin (0.5 Sv (50 rem)), extremities [0.5 Sv (50 rem)], and on the committed dose equivalent to any internal organ [0.5 Sv (50 rem)]. Annual radiation exposure for an employee will be controlled, monitored, and maintained ALARA through the radiation safety program at the IIFP plant.

The Environmental Protection Agency (EPA) and the Occupational Safety and Health Administration (OSHA) have developed exposure limits for Hydrogen Fluoride (HF). These regulations are enforceable by law. Recommendations for public health have also been developed, but cannot be enforced by law; however, accidental release criteria have been established by the EPA for reportability and public protection. Federal organizations that develop recommendations for public health from toxic substances are the Agency for Toxic Substances and Disease Registry (ATSDR) and the National Institute for Occupational Safety and Health (NIOSH). The American Conference of Governmental Industrial Hygienists (ACGIH) also provide occupational exposure limits for HF, which are updated periodically and whose research is used by NIOSH, which in turn provides data and recommendations to OSHA.

Of primary importance to IIFP is the control of depleted uranium hexafluoride (DUF_6). UF_6 readily reacts with air, moisture, and some other materials. The most significant UF_6 reaction products in this plant are hydrogen fluoride (HF), uranyl fluoride (UO_2F_2), and small amounts of uranium tetrafluoride (UF_4). Of these, HF is the most significant hazard, being toxic to humans. When UF_6 reacts with moisture, it breaks down into UO_2F_2 and HF. The health dangers of UF_6 stem more from its chemical properties than from its radiological properties.

Contact with HF can cause severe irritation of the eyes, inhalation can cause extreme irritation of the respiratory tract, and ingestion can cause vomiting, diarrhea and circulatory collapse. Initial exposure to HF may not cause the appearance of a typical acid burn; instead the skin may appear reddened and painful, with increasing damage occurring over a period of several hours or days. Tissue destruction and loss can occur with contact to HF; and in worst cases, large doses of HF can cause death due to the fluoride affecting the heart and lungs. The actual amount of HF that can cause death has not been quantified. Breathing moderate amounts of HF for several months caused rats to develop kidney damage and nervous system changes, as well as learning problems. Inhalation of HF or HF-containing dust will cause skeletal fluorosis, or changes in bones and bone density (HHS, 2001).

OSHA has set a limit of 2.0 mg/m^3 for HF for an 8-hr work shift, while the NIOSH recommendation is 2.5 mg/m^3 (NIOSH, 2001). As with most toxicological information and health exposure regulations, limits have been established based on past exposures, biological tests, accident scenarios and lessons learned, and industrial hygiene data that is continually collected and researched in occupational environments.

3.12 Waste Management

Waste Management for the IIFP facility is divided into gaseous and solid wastes. Descriptions of the generation, management, and disposal of various wastes from construction and operations are discussed in this section. Disposal plans, waste minimization, and environmental impacts are discussed in ER Section 4.13, "Waste Management Impacts."

3.12.1 Gaseous Waste Streams

Gaseous wastes generated at the IIFP occur in the form of air emissions released to the atmosphere from the operations of the facility. Sources, quantities, and control of gaseous air emissions from the operations at the IIFP facility are described in Section 4.6.2.1, "Description of Gaseous Effluents."

3.12.2 Solid Waste Management

Solid waste generated at the IIFP plant will be grouped into industrial (nonhazardous), radioactive and mixed, and hazardous waste categories. In addition, solid radioactive and mixed waste will be further segregated according to the quantity of liquid that is not readily separable from the solid material. The solid waste management systems will be a set of facilities, administrative procedures, and practices that provide for the collection, temporary storage, (no solid waste processing is planned), and disposal of categorized solid waste in accordance with regulatory requirements. Solid radioactive wastes generated will be low-level wastes (LLW) as defined in 10 CFR 61 (CFR, 2009e). See Table 3-55, "Estimated Annual Quantities of Waste Generated at the IIFP Facility."

Table 3- 55 Estimated Annual Quantities of Waste Generated at the IIFP Facility

Material	Phase 1 (lb)	Total Phase 1 and Phase 2 (lb)
Depleted uranium oxide including drums	2,800,000-6,000,000	8,700,000-18,000,000
Other process LLW	42,000-68,000	45,500-73,000
Misc, LLW	35,000-55,000	70,000-100,000
RCRA	32,300-361,500*	45,500-174,000*
Industrial waste including sanitary waste	71,000-108,500	85,400-135,000

*Includes Calcium Fluoride which if sold may not be RCRA Waste

The depleted uranium oxide waste from the de-conversion process is shipped to an off-site LLW disposal facility licensed for accepting depleted uranium oxide.

Industrial waste, including sanitary waste, miscellaneous trash, vehicle air filters, empty cutting oil cans, miscellaneous scrap metal, and paper will be shipped off site for minimization, if appropriate, and then sent to a licensed waste landfill.

Radioactive waste, including dust collector bags, ion exchange resin, crushed contaminated drums, contaminated trash, contaminated coke, carbon trap material will be collected in labeled containers in each Restricted Area and transferred to the Radioactive Waste Storage Area for inspection. Suitable waste will be volume-reduced, if appropriate, and radioactive waste disposed of at a licensed low-level waste (LLW) disposal facility.

Hazardous wastes and some mixed wastes will be generated at the IIFP site. These wastes will also be collected at the point of generation, transferred to the Waste Storage Area, inspected, and classified. Any mixed waste that may be processed to meet land disposal requirements may be treated in its original collection container and shipped as LLW for disposal.

Resource Conservation and Recovery Act (RCRA) hazardous wastes will be collected and packaged in approved containers and shipped by a licensed RCRA transporter and sent to licensed RCRA disposal

facility. Under New Mexico regulations, a facility that generates more than 1,000 kg (2,200 lb) per month is a large quantity generator of RCRA wastes. In New Mexico, hazardous waste generators are classified by the actual monthly generation rate, not the annual average.

There is no on-site disposal of any solid or liquid waste at the IIFP facility. Waste management impacts for on-site disposal, therefore, are not evaluated.

3.12.2.1 Construction Wastes

Efforts are made to minimize the environmental impact of construction. Erosion, sedimentation, dust, smoke, noise, unsightly landscape, and waste disposal are controlled to practical levels and permissible limits, where such limits are specified by regulatory authorities. In the absence of such regulations, IIFP will ensure that construction proceeds in an efficient and expeditious manner, remaining mindful of the need to minimize environmental impacts.

Wastes generated during site preparation and construction will be varied, depending on the activities in progress. The bulk of the wastes will consist of non-hazardous materials such as packing materials, paper and scrap lumber. These types of wastes will be transported off site to an approved landfill.

Hazardous wastes that may be generated during construction include paint, solvents, thinners, organics; petroleum products, oils, lubricants; adhesives, resins, sealers, caulking; lead (batteries); and pesticides. Any such wastes that are generated will be handled by approved methods and shipped off site to approved disposal sites.

A Spill Prevention, Control and Countermeasure (SPCC) Plan is implemented during construction to minimize both the possibility of spills of hazardous substances, and to minimize the environmental impact of actual spills. The SPCC ensures prompt and appropriate remediation. Spills during construction are more likely to occur around vehicle maintenance and fueling operations, storage tanks, painting operations and warehouses. The SPCC plan identifies sources, locations and quantities of potential spills and provides appropriate response measures. The plan identifies individuals and their responsibilities for implementation of the plan and provides for prompt notifications of state and local authorities, when required.

3.12.2.2 Scrap Metal

Metallic wastes are generated during routine and abnormal maintenance operations. The metal may be clean or contaminated with radioactive or hazardous material. Radioactive contamination of scrap metal is in the form of surface contamination caused by uranium compounds adhering to the metal or accumulating in cracks and crevices.

Clean scrap metal is collected in bins. This material is transported by contract carrier to a local scrap metal vendor for disposal. Items collected outside of Restricted Areas are disposed of as industrial scrap metal unless there is reason to suspect they contain hazardous material.

Scrap metal is monitored for contamination before it leaves the site. Metal found to be contaminated is either decontaminated or disposed of as radioactive waste. When feasible the material is reduce in size prior to disposal at a licensed disposal facility.

Metallic items containing hazardous materials are collected at the location of the hazardous material. The items are wrapped to contain the material and taken to the waste storage area. The items are then cleaned

on site, if practical. If on-site cleaning cannot be performed then the items are sent to a hazardous waste processing facility for off-site treatment or disposal.

3.12.3 Process and Non-Process Waste Waters

No process effluents are treated and recycled or reused within the processes. Relatively small amounts of aqueous and non-aqueous liquid waste generation can be expected. These miscellaneous materials are collected in approved containers. Solutions containing uranium may be sent to the Decontamination Building for removal of the uranium followed by evaporation of the treated water. Aqueous laboratory samples and other miscellaneous liquids from maintenance activities that may contain uranium are sampled to determine their uranium or hazardous waste content, collected in approved containers and sent to an approved licensed disposal facility appropriate for that type hazardous material, if applicable. Where potentially contaminated areas have to be cleaned with solutions, the solution, if contaminated, is sent to the De-contamination Building to remove uranium, evaporate the liquids, and packaging of any uranium residues for shipment to an off-site licensed disposal facility.

Non-process waste liquids that are determined to contain regulated or hazardous contaminants are collected and disposed at off-site licensed facility. Cooling water is recycled and steam condensate is either reused as process makeup water or treated and returned to the boiler.

A retention basin is used for the collection and monitoring of general site storm water runoff. Sanitary sewage effluent is discharged into a package treatment unit where it receives primary, secondary and tertiary treatment. The effluent from sanitary treatment is used in the plant for process make-up water or for landscape or site tree watering.

4. ENVIRONMENTAL IMPACTS

This chapter evaluates the potential environmental impacts associated with the construction and operation of the Proposed IIFP Facility. This chapter is divided into sections that assess the impact on each related resource described in Chapter 3, "Description of the Affected Environment." These include land use, transportation, geology and soils, water resources, ecological resources, air quality, noise, historic and cultural resources, and visual/scenic resources. Other topics include socioeconomic, environmental justice, public and occupational health, and waste management.

A standard of significance has been established for assessing environmental impacts. Based on the regulations developed by the Council on Environmental Quality, and promulgated by the NRC, each impact is to be assigned one of the following three significance levels:

- **SMALL:** The environmental effects are not detectable or are so minor that they neither destabilize nor noticeably alter any important attribute of the resource.
- **MODERATE:** The environmental effects are sufficient to noticeably alter but not destabilize important attributes of the resource.
- **LARGE:** The environmental effects are clearly noticeable and are sufficient to destabilize important attributes of the resource. (NRC, 2003a)

4.1 Land Use Impacts

4.1.1 Proposed Action

The Proposed Action, as described in Section 2.1.2, "Proposed Action," is that International Isotopes, Inc. (IIFP) will construct and operate a facility that will use depleted uranium hexafluoride (DUF_6) to produce inorganic fluorides, uranium oxide, and anhydrous hydrofluoric acid (AHF). Figure 4-1 presents a schematic of the integrated facility showing the location of process buildings, roads, grounds, and other non-production facilities.

4.1.1.1 Construction Impacts

The Proposed IIFP Facility will be built on approximately 16.2 ha (40 ac) of a 259-ha (640-ac) Section. The IIFP facility will be built approximately in the center of the site. This site will be carved out of the 959-ha (2,369-ac) Section as shown in the Figure 2-5 in Section 2.1.2.1 "Description of the Proposed Site." The site is currently undeveloped except for electrical power lines and gas pipelines crossing the site. This area within New Mexico has been previously developed by the oil and gas industries and is less agricultural than the area across the state border into Texas. See Figure 4-2, "Aerial Photograph of Southeastern New Mexico and West Texas in the Hobbs Area."

It is anticipated that construction will occur in three phases. The first phase will involve certain pre-licensing construction tasks based on approval of an exemption prior to NRC approval of the license for the Phase 1 facility. These activities could begin as early as 2011. They will be preparatory in nature and will not involve any process or safety related equipment or systems. The pre-licensing construction

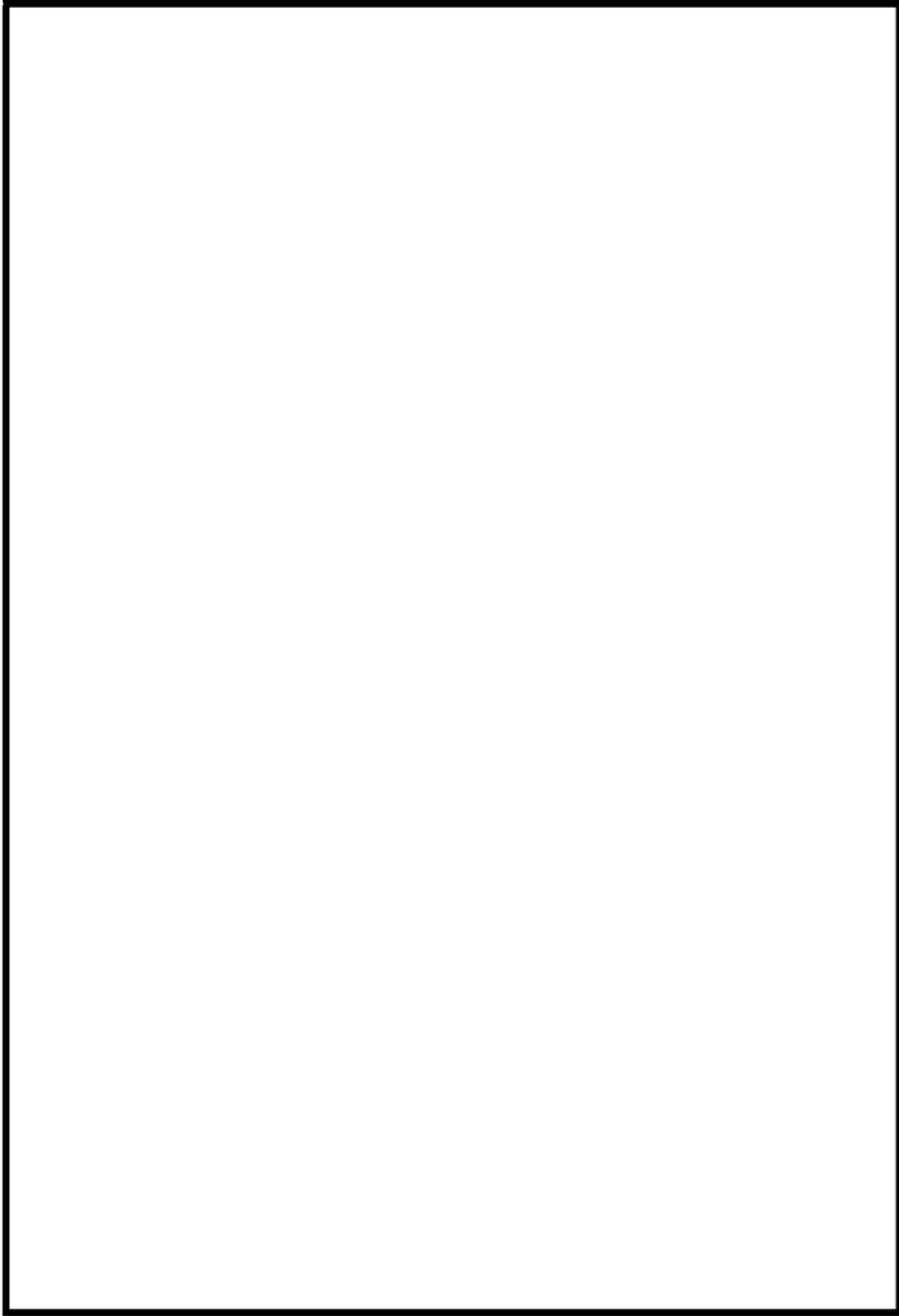

Figure 4- 1 ~~Integrated Facility~~ Redacted Security Related Information



Figure 4- 2 Aerial Photograph of Southeastern New Mexico and West Texas in the Hobbs Area

activities only affect the timing of work and will not increase the scope or environmental impact of facility construction. Potential pre-licensing construction activities may include the following:

- Clearing land,
- Site grading and erosion control,
- Installing main entrance roadbed and drainage to highway,
- Installing construction trailer,
- Preparing preliminary site roadways and gravel parking area,
- Potential drilling of water wells,
- Constructing power substation,
- Stubbing in gas line to the meter,
- Beginning administration building construction,
- Beginning warehouse building construction,
- Installing geothermal heating/cooling loops, and
- Installing firewater tanks.

The second construction phase will begin after NRC approval of the license. This phase will complete any unfinished pre-licensing construction activities and will perform general construction through completion of the Phase 1 facility. The third construction phase is expected to begin in 2015 and will complete the Phase 2 facility to add DUF₆ de-conversion capacity.

During the construction phases of the IIFP Site, conventional earthmoving and grading equipment will be used. The removal of very dense soil (caliche) may require the use of heavy equipment with ripping tools. Soil removal work for foundations will be controlled to minimize excavation. In addition, loose soil and/or damaged caliche will be removed prior to installation of foundations for seismically designed structures. Approximately 6.3% of the total site area will be disturbed, affording wildlife of the site an opportunity to move to undisturbed on-site areas or to additional areas of suitable habitat bordering the IIFP Site. No mitigation is necessary to offset this SMALL impact.

4.1.1.2 Utilities

The IIFP plant will require the installation of water, natural gas, and electrical utility lines. It is expected that these utilities will be installed during the pre-licensing construction period. In lieu of connecting to the local sewer system, sanitary waste will be tertiary-treated on site and reused in plant processes or for landscape watering.

Two wells will be drilled on site to supply potable water, process makeup water, and fire water. The Site is over the Ogallala Aquifer. These wells will have a SMALL impact on land use and do not require mitigation measures.

The natural gas line feeding the Site will connect to an existing, nearby line. This will minimize impacts of short-term disturbances related to the placement of the tie-in line. The gas line will have a SMALL impact on land use and does not require mitigation measures.

A new electrical transmission line is proposed for providing electrical service to the IIFP facility. There are currently 115 and 230 kV transmission lines along U.S. Highway 62/180 (U.S. 62/180) and New Mexico Highway 483 (NM 483). In conjunction with the new electrical lines serving the Site, the local electrical utility company will install an independent substation to ensure service. The electrical transmission lines and the new substation have a SMALL impact on land use and do not require mitigation measures.

4.1.1.3 Operations

The operation of the plant is not anticipated to significantly affect land use. Land use impacts to the site and vicinity will be minimal considering that the majority of the site will remain undeveloped, the current industrial activity on neighboring properties, the nearby expansive oil and gas well fields, and the placement of most utility installations along highway easements. Operation of the IIFP facility has a SMALL impact on land use and does not require mitigation measures.

4.1.1.4 Decommissioning

The plans for decommissioning of the Proposed IIFP Facility are described in the License Application, Chapter 10, "Decommissioning." At the end of useful plant life, the IIFP facility will be decommissioned such that the Site and remaining facilities may be released for unrestricted use and for NRC license termination pursuant to 10 CFR 20.1401 and 20.1402 (CFR, 2009a). Process equipment will be removed; only building shells and the site infrastructure will remain. All remaining facilities will be at acceptable levels for unrestricted use. Therefore, land use impacts resulting from the decommissioning of the Proposed IIFP Facility are SMALL.

4.1.2 Cumulative Impacts

The IIFP site and the surrounding land have been and continue to be used for livestock grazing, oil and gas production, and power generation. Except for pre-licensing and general construction, operation, and eventual decommissioning of the IIFP plant, the land use is expected remain virtually unaffected. There are no anticipated cumulative impacts from these uses. The cumulative land use impacts resulting from the Proposed IIFP Facility are SMALL.

IIFP is not aware of any federal action that will have cumulatively significant land use impacts. Except for the proposed construction of the IIFP facility, there are no other known current or future land use

plans, including staged plans, for the site or immediate vicinity. Similarly, since the site is not subject to local or county zoning, land use planning or associated review process requirements, there are no known potential conflicts of land use plans, policies or controls.

4.1.3 Control of Impacts

The anticipated effects on the soil during construction activities are limited to a potential short-term increase in soil erosion. However, this will be mitigated by design considerations and construction best management practices (BMP). These practices include minimizing the construction footprint to the extent possible, limiting site slopes to a horizontal to vertical ratio of three to one or less, the use of a sedimentation retention basins, protection of undisturbed areas with silt fencing and straw bales as appropriate, and site stabilization practices such as placing crushed stone on top of disturbed soil in areas of concentrated runoff. In addition, as indicated in mitigation measures ER Section 5.2.2, "Transportation," on-site construction roads will be periodically watered down, if required, to control fugitive dust emissions. Water conservation will be considered when deciding how often dust suppression sprays will be applied. After construction is complete, the site will be stabilized with natural, low-water maintenance landscaping and pavement.

Impacts to land and groundwater will be controlled during construction activities through compliance with the National Pollution Discharge Elimination System (NPDES) Construction General Permit obtained from Region 6 of the Environmental Protection Agency (EPA). A Spill Prevention, Control and Countermeasures (SPCC) plan will also be implemented during construction activities to minimize environmental impacts from potential spills and to ensure prompt and appropriate remediation. Potential spills during activities are likely to occur around vehicle maintenance and fueling locations, storage tanks, and painting operations. The SPCC plan identifies sources, locations and quantities of potential spills and response measures. The plan also identifies individuals and their responsibilities for implementation of the plan and provide for prompt notifications of state and local authorities, as required.

Waste management BMPs are used to minimize solid and hazardous waste materials. These practices include the placement of waste receptacles and trash dumpsters at convenient locations and the designation of vehicle and equipment maintenance areas for the collection of oil, grease and hydraulic fluids. Where practicable, materials suitable for recycling are collected. Adequately maintained sanitary facilities are provided for construction crews.

4.1.4 Comparative Land Use Impacts of Alternative Actions

ER Chapter 2 provides a discussion of possible alternatives to the construction and operation of the IIFP facility, including an alternative of "No-Action," i.e., not building the IIFP facility. Additionally, IIFP considered reasonable alternatives using alternative technologies for de-conversion services and production of fluorine products.

4.1.4.1 No-Action Alternative

The DOE de-conversion facilities are sized and built to dispose of the DOE DUF₆ inventory. The de-conversion and disposal is expected to take 20 to 25 years. If DOE were to process privately owned DUF₆, de-conversion would likely have to await completion of the DOE mission or DOE would have to add additional capacity to their plants. A 20 to 25 year delay in processing the DUF₆ would force private enrichment facilities to store tails on site or to build or use their own de-conversion facilities.

The No-Action Alternative of long-term storage of DUF_6 may present potential unnecessary risk to the public. If DOE were to expand its facilities for additional capacity, additional land use impacts will be incurred at Paducah, KY and/or Piketon, OH. If the Proposed Action is not implemented, there will be no land use impact to New Mexico.

4.1.4.2 Reasonable Alternative Actions

One of the Reasonable Alternatives considered the utilization of the alternate DOE de-conversion technology on the Proposed IIFP Site near Hobbs, New Mexico. This alternative technology is the same as that which will be used in the de-conversion process utilized at the DOE sites at Paducah, KY and Piketon, Ohio. With this DOE technology, UF_6 reacts with water and hydrogen to produce uranium oxide, which must be disposed of as waste in a licensed facility, and aqueous HF that has a lower market value than AHF. The land use impacts of this alternative are potentially greater in the event that relatively large amounts of aqueous HF cannot be sold. In this case, treatment facilities would be required, and the treatment could result in generation of large amounts of materials for disposal. If the treated materials are not sold, then materials would have to be disposed of in a licensed facility.

Two of the enrichment companies have de-conversion facilities overseas and could choose to ship their DUF_6 from the U.S. to those facilities for de-conversion. Those companies that do have existing overseas facilities and technologies would be required to ship DUF_6 overseas long-distances and may have to return the waste oxides to United States for licensed disposal or may have to arrange with other countries for disposal. It is expected that land use impacts for this option of shipping the DUF_6 overseas may be greater than the Proposed Action, if aqueous HF generated by this alternative is not marketable or sold. This potentially greater impact is due to the difference in technologies that produce HF, and in the case of aqueous HF, results in the treatment and generation of CaF_2 waste, if the CaF_2 cannot be sold.

The four enrichment companies could decide to build and operate their own de-conversion facilities in the U.S. If those companies were to build new facilities to de-convert “tails” material, it is expected that the land use impacts for this Reasonable Alternative are expected to be greater than the Proposed Action, if aqueous HF generated by this alternative is not marketable or sold. As above, this potentially greater impact is due to the difference in technologies that produce aqueous HF and in the treatment and generation of CaF_2 waste if it cannot be sold.

See Section 4.1.4.2, for the environmental impacts on land use should the enrichment companies utilize the present DOE de-conversion facilities.

4.2 Transportation Impacts

The IIFP site is located in southeastern New Mexico near the New Mexico/Texas state line in Lea County, New Mexico. The site lies along the north side of U.S. 62/180 and the east side of NM 483 running north to Lovington. See Figure 4-3, “Cities and Major Roads around Hobbs New Mexico.” U.S. 62/180 intersects NM 18 providing access from the city of Hobbs south to Eunice and Jal, New Mexico. NM 132 runs north from Hobbs at the intersection with U.S. 62/180 to Denver City. U.S. 62/180 runs southwest to Carlsbad, New Mexico, approximately 81 km (50 mi) from the proposed site. U.S. 62/180 runs east through Seminole, Texas, 45 km (28 mi) from Hobbs to Forth Worth, Texas, 547 km (340 mi) from the site. The nearest U.S. Interstate is Interstate 20, approximately 145 km (90 mi) to the southeast in Odessa, Texas. For the location of the interstate with reference to the site, see Figure 3-4 in ER Chapter 3.

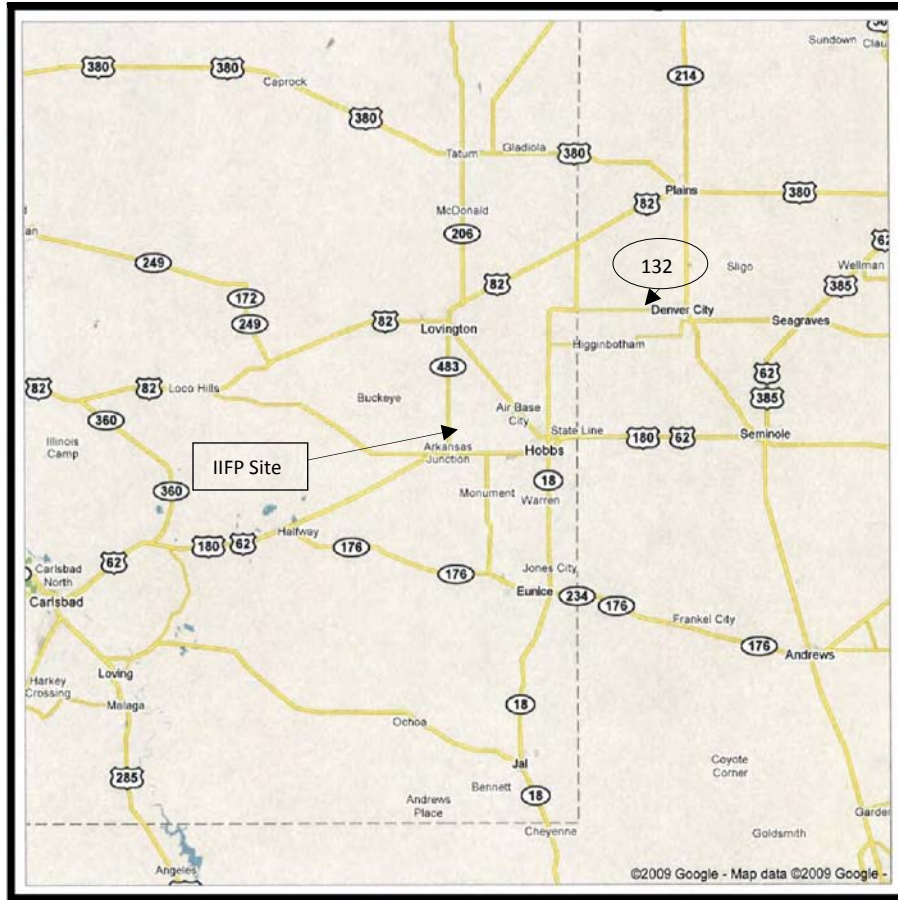

Figure 4- 3 Cities and Major Roads around Hobbs New Mexico

4.2.1 Transportation Mode

IIFP plans to use trucks and common carrier to make shipments during construction and operations. Therefore, the impacts of rail traffic are not evaluated. If rail shipments are needed for construction to bring large items to locations close to the plant where rail service is available, they are not expected to be a significant impact since they will be infrequent and will be managed as routine railroad traffic. Additionally, it is assumed that no air shipments will be used during construction or operation of the IIFP facility. Therefore, the impacts of air shipments are not evaluated. If air shipments are needed to bring specific items to the site, they are not expected to be a significant impact since they will be infrequent and will be managed as routine airfreight. Thus, the mode of transportation for construction and operation of the IIFP facility will consist of over-the-road trucks, ranging from heavy-duty 18-wheeled delivery trucks, concrete mixing trucks and dump trucks, to box and flatbed type light-duty delivery trucks. The primary transportation mode for the workforce to and from the site will be by car, truck, or van.

4.2.2 Transportation Route

The primary transportation route to the site from the east and west is U.S. 62/180, which leads directly by the site between Hobbs and Carlsbad. As seen in Table 4-1, from 2006 through 2008, the traffic count on U.S. 62/180 averaged 5,330 vehicles at the NM/Texas state line, increased to 6,980 at Hobbs, and slightly decreased to 6,460 at the junction of NM 8 which heads south through Monument and to Eunice via NM

176/234. Traffic count dropped significantly to 3,420 at NM 483 near the IIFP site before increasing to 4,090 at the Eddy County line, and dramatically increasing to 9,400 at Carlsbad. The percent commercial truck traffic ranged from 7% at the New Mexico state line to 52% past the site, then down to 25% at Carlsbad. NM 483 will be used for construction materials needed from the north from Lovington.

As can be seen in Table 4-2, the north-south traffic count for the same three years averaged 975 at the junction of NM 483 and U.S. 62/180 to Lovington. Commercial vehicles accounted for 44% of the traffic on NM 483. Some materials may come from the south (Eunice) via NM 234 and NM 8 then U.S. 62/180. The average vehicle traffic over NM 8 was 1,340 vehicles per day, with 39% attributed to commercial vehicles. An alternate route from the south at Jal, New Mexico through Eunice will be via NM 18 to Hobbs then U.S. 62/180 to the site. The traffic count averaged 2,000 vehicles at Jal, increased to 5,625 at

Table 4- 1 East-West Traffic Volume on U.S. Highways 62/180

Location of Traffic Count	Volume Characteristic (Average Annual Daily Traffic with Percent Commercial Truck)					
	2008		2007		2006	
	Number	%	Number	%	Number	%
At Carlsbad, NM (Mile 36.4) ¹	6,421	25	10,971	25	10,815	25
At Eddy/Lea County Lines (Mile 62.4) ²	4,058	43	4,102	43	4,110	43
At JCT NM 483 (Mile 92.1) ²	3,394	52	3,434	52	3,439	52
At JCT NM 8 (Mile 97.1) ¹	7,868	33	5,745	33	5,757	33
At Hobbs, NM (Mile 103.4) ²	7,052	12	6,993	12	6,894	12
1.2 Miles West of NM/Texas State Line (Mile 108.5) ¹	5,300	7	5,500	7	5,200	7

Source: NMDOT, 2009

¹Count derived from recent coverage counts

²Annual growth factor generalized from coverage counts within the traffic segment and updated with loop and growth factors

Table 4- 2 North-South Traffic Volumes on Other Highways in the Area of Influence

Highway/Location of Traffic Count	Volume Characteristic Average Annual Daily Traffic with Percent Commercial Truck)					
	2008		2007		2006	
	Number	%	Number	%	Number	%
NM 483 at JCT U.S. 62/180	955	44	975	44	998	44
NM 483 at Lovington ²	955	44	975	44	998	44
NM 8 at JCT NM 176 ²	1,325	38	1,353	38	1,385	38
NM 8 at U.S. 62/180 ²	1,302	40	1,329	40	1,360	40
NM 18 at JCT NM 128 in Jal, NM ¹	2,344	41	1,835	41	1,816	41
NM 18 at JCT 176 at Eunice, NM ¹	5,762	31	5,586	31	5,527	31
NM 18 at JCT U.S. 61/180 at Hobbs ²	12,407	16	12,303	16	11,705	16
NM 18 at JCT Avenue K in Lovington ²	7,588	16	7,525	16	7,418	16
NM 132 at Hobbs ²	2,122	42	2,186	42	2,227	42
NM 132 at JCT NM 83 West to Lovington ¹	1,550	36	1,650	36	1,500	36

Source: NMDOT, 2009

¹Count derived from recent coverage counts

²Annual growth factor generalized from coverage counts within the traffic segment and updated with loop and growth factors

Eunice, then further increased to 12,140 vehicles at Hobbs with the commercial truck traffic accounting for 41%, 31%, and 16%, respectively.

4.2.3 Traffic Pattern

U.S. 62/180 provides a direct access past the site. The site access road is off NM 483 approximately 2.4 km (1.5 mi) north of the intersection with U.S. 62/180 (Arkansas Junction). Considering that U.S. 62/180 is a divided 4-lane highway and serves as a main east-west trucking thoroughfare for local industry, it should be able to handle the increased heavy-duty traffic adequately since the traffic count is significantly less at the site than in the urban ends of the highway at the Hobbs and Carlsbad areas.

Table 4-3 provides the latest census data for workers (16 years and over) commuting to work in Lea County. Approximately 93% of the 19,828 workers in Lea County in 2000 used vehicles in getting to work.

Table 4- 3 Workers 16 Years and Over Commuting to Work in Lea County

Mode of Transportation	Number	Percentage (%)
Car, Truck, or Van, Drove Alone	15,626	78.8
Car, Truck or Van, Carpooled	2,963	14.9
Public Transportation (Including Taxicab)	21	0.1
Walked	343	1.7
Other Means	339	1.7
Worked at Home	536	2.7
Total	19,828	100
Mean Travel Time to Work (Minutes)	18.7	N/A

Source: USCB, 2000

4.2.4 Proposed Action

The Proposed Action, as described in Section 2.1, “Proposed Action,” IIFP will construct and operate a facility that will use DUF₆ to produce inorganic fluorides, uranium oxide, and anhydrous hydrofluoric acid. Figure 4-1 presents a schematic of the integrated facility showing the location of process buildings, roads, grounds, and other non-production facilities.

4.2.4.1 Construction of Access Road

Access to the site will be directly off of NM 483. The access roadway will eventually be converted to a permanent access road upon completion of construction. Therefore, impacts from this access road construction will be SMALL.

4.2.4.2 Construction

The impact on Transportation of IIFP employees is minimal (5-10) during the pre-licensing construction period. The number of construction workers during the pre-licensing construction period is estimated at between 30 and 60 per day. During Phase 1 construction activities the number of workers is estimated at between 90 and 150 per day. The maximum number of construction workers during the peak of the facility construction including Phase 2 is estimated at 200. Thus, the maximum potential increase from construction worker traffic during the construction phases is 200 roundtrips per day.

The maximum potential daily increase to traffic due to construction deliveries and waste removal will be about 20 roundtrips per day over the site preparation and major building construction period. This value is based on the estimated number of material deliveries and construction waste shipments during the period of site preparation and major building construction.

If all the construction traffic used the access road off NM 483, this will result in a 42% increase in traffic on that 2-lane highway. The vast majority of this increase is expected to be on the 1.5 mile section between the access road and U.S. 62/180. Compared with the traffic count for the various highways from 2006 through 2008 and the transportation commuting statistics in Lea County from the 2000 census data, the impact of this temporary increase in traffic during construction is considered SMALL to MODERATE for the peak construction period.

4.2.4.3 Operations

As stated in ER Section 4.10.2.1, the operational workforce at the IIFP plant during Phase 1 will be up to 138 employees. Thus the maximum potential increase to traffic due to operational workers is 138 roundtrips per day. This is an upper bound estimate since all workers do not work on any given day and some may carpool. It is anticipated that operations will be conducted using three 8-hour shifts per day. Operational shift changes for site personnel are estimated to average 40 to 60 vehicles per shift change. Considering both the leaving shift and the incoming shift, the operational shift change will double to 80 to 120 vehicles. This will amount to increased traffic of 240 to 360 vehicles per day for operational personnel.

After Phase 2 is operational, total plant employee population is estimated up to 160.

The increase in traffic on NM 483 will be 12% during each shift change or a 37% increase in traffic per day. If all the traffic went east/west on U.S. 62/180, this will be less than 4% increase at Arkansas Junction at each shift change or an 11% increase in traffic per day. The Proposed Action will have a SMALL to MODERATE impact on the transportation pattern from IIFP operations personnel.

The maximum potential increase to traffic due to operational deliveries and waste removal shipments is estimated at about 2,650 roundtrips per year. This value is based on estimated 550 radiological shipments per year plus 2,100 non-radiological shipments per year. Thus, an average of approximately 10 roundtrips for operational deliveries and waste management will occur daily during a normal 5-day work week. Compared with the transportation commuting statistics in Lea County from the 2000 census data and the traffic count on the specific highways, this increase in traffic from operational deliveries and waste removal will be SMALL. One mitigation measure to be considered by IIFP is to schedule operations worker shift changes and truck shipments for off-peak traffic periods, when practical.

Leaving the plant site on south NM 483, most vehicles will likely travel east at Arkansas Junction on U.S. 62/180 towards the city of Hobbs, New Mexico, and Seminole, Texas or turn south on NM 8 toward Eunice, New Mexico and then to NM 18 towards the city of Jal, New Mexico. Personnel leaving the plant site could also turn north onto NM 483 towards the city of Lovington, New Mexico. From U.S. 62/180 at Arkansas Junction, some vehicles will turn west toward the western part of Lea County and to Eddy County to Carlsbad. Considering the amount of traffic that nearby roadways experience on a daily average, the increase in vehicle flow associated with site construction and on-site operations will be low to moderate. Generally, as the distance from the site increases, impacts to the transportation network are expected to decrease as traffic becomes more dispersed.

4.2.4.4 Decommissioning

The plans for decommissioning of the Proposed IIFP Facility are described in Chapter 10 of the License Application, Decommissioning. The number of on-site workers required during the decommissioning phase of the Proposed IIFP Facility once production ceases is projected to be approximately 40 workers. This is 110 fewer workers than the number projected for the Phase 2 production of the IIFP facility. Decommissioning of the Proposed IIFP Facility will include the decontamination and removal of the equipment and other materials being shipped for off-site disposal. The number of truck shipments will depend on the quantities of equipment and waste materials resulting from decommissioning. It is expected that the average number of truck shipments from the site will be similar to the average daily truck traffic during the initial pre-licensing and general construction phases.

Radioactively-contaminated equipment and materials removed during decommissioning that require off-site disposal will be shipped to a licensed treatment or disposal facility (as appropriate for the material type) or disposed of in a manner authorized by the NRC. The transport of these shipments will comply with applicable NRC and U.S. Department of Transportation (DOT) requirements in effect at the time of facility closure. These truck shipments will occur over the period anticipated to complete the decommissioning activities. The number of truck trips from the Proposed IIFP Site, the destinations for those trips, and the routes used to travel to those destinations will depend on the quantities and types of equipment and demolition material shipped off site, as well as the locations of the treatment and disposal facilities open and with capacity to receive the shipments at the time that decommissioning will begin.

The transportation impacts associated with decommissioning of the Proposed IIFP Facility will be temporary and variable over the decommissioning period for the IIFP facility. Given the significant reduction in the number of on-site workers, the level of expected truck traffic, and the relatively short duration for many of the expected decommissioning activities, the transportation impacts of the Proposed Action during decommissioning are anticipated to be SMALL to MODERATE.

4.2.5 Other Construction Transportation Impacts

Impacts from construction transportation will include the generation of fugitive dust, changes in scenic quality, and added noise.

Dust will be generated to some degree during the various stages of construction activity. The amount of dust emissions will vary according to the types of activity. The first five months of construction will likely be the period of highest emissions since approximately 16.2 ha (40 ac) of the 259 ha (640 ac) will be involved, along with the greatest number of construction vehicles operating on an unpaved surface. Pre-licensing construction activities will reduce the maximum concentration of emissions but will extend the period over which emissions are generated. During construction of the Phase 2 facility, dust emissions will be considerably less since the access road and the plant roads will already be paved.

Air quality impacts from general construction site preparation for the IIFP plant have been evaluated using emission factors. Emission rates for fugitive dust were estimated using emission factors provided in AP-42, the U.S. Environmental Protection Agency's Compilation of Air Pollutant Emission Factors (EPA, 2009a). A more detailed discussion of air emissions can be found in ER Section 4.6.1, "Air Quality Impacts from Construction." The air quality impacts due to construction activities are SMALL.

Fugitive dust emission rates were assumed to be from a uniform area source with emissions occurring 10 hours per day, 5 days per week, and 50 weeks per year. This also assumes peak construction activity levels were maintained throughout the construction period. Emissions from fugitive dust were below the

National Ambient Air Quality Standards (NAAQS) (CFR, 2009i). Additionally, pre-licensing construction will lower the work density and therefore the maximum concentration of emissions/particulates. These conservative assumptions will result in predicted air concentrations that tend to overestimate the potential impacts. Fugitive dust will originate predominantly from vehicle traffic on unpaved surfaces, earth moving, excavating and bulldozing, and to a lesser extent from wind erosion.

Although plant construction will significantly alter its natural state of the site, there are no high quality viewing areas nearby and there is existing industrial development on surrounding properties. Therefore, impacts to the scenic quality of the site are considered to be SMALL. Also, construction vehicles are comparable to trucks servicing neighboring facilities.

As detailed in ER Section 4.7, "Noise Impacts," the temporary increase in noise levels along U.S. 62/180 and NM 483 due to construction vehicles is not expected to impact nearby receptors significantly, due to substantial truck traffic currently using these roadways and the distance to the receptors. Noise impacts due to construction traffic are SMALL.

4.2.6 Radioactive Material Transportation

The DUF₆ suppliers (customers) to IIFP have approval through their NRC license to use the type 48-Y or type 48-G cylinder design for containing DUF₆. These cylinders have a 14-ton (12-metric-ton) capacity. Cylinders shipped to the IIFP plant are transported by truck trailers that are Department of Transportation (DOT) approved. 48Y cylinders are designed, fabricated and shipped in accordance with ANSI N14.1, "Uranium Hexafluoride—Packaging for Transport." These will be transported by 18 wheel trucks, one per trailer/truck. Once the DUF₆ contents have been fed through the autoclaves at the IIFP facility, each cylinder will have remaining material (heel) of less than 23 kg (50 lb) of DUF₆ and uranium daughter products. Empty cylinders are shipped back to the suppliers/customers for refilling, after they have been weighed, inspected, and monitored.

The type 48-G cylinders may require the supplier/customer to obtain a DOT exemption for over-the-road shipment. The type 48-G cylinders have been shipped in the past by the Department of Energy, but typically it has been used in the industry as an on-site storage cylinder for DUF₆. If a customer were to contract for shipments of DUF₆ to the IIFP facility using type 48-G cylinders, the arrangement would require completely emptying the cylinder into the IIFP process and providing for final disposition of the empty cylinder. One means of disposing of the empty cylinder is to use it as a waste container for uranium oxide that is sent to the licensed disposal facility.

Radioactive material shipments will be transported in packages that meet the requirements of 10 CFR 71 and 49 CFR 173 (CFR, 2009m; CFR, 2009ii). The NRC has evaluated the environmental impacts resulting from the transport of nuclear materials in NUREG-0170, "Final Environmental Statement on the Transportation of Radioactive Material By Air and Other Modes" (NRC, 1977a), updated by NUREG/CR-4829, "Shipping Container Response to Severe Highway and Railway Accident Conditions" (NRC, 1987a). These references include accident scenarios related to the transportation of radioactive material. The NRC found that the accidents evaluated have no significant environmental impacts and the results bound IIFP transportation accidents. The materials that will be transported to and from the IIFP facility are within the scope of the environmental impacts evaluated by the NRC. Because these impacts have been addressed in a previous NRC environmental impact statement, these impacts do not require further evaluation in this report.

The dose equivalent to the public and worker for incident-free transportation has been conservatively calculated to illustrate the relative impact resulting from transporting radioactive material. Depleted

uranium feed and associated low-level waste (LLW) will be transported to and from the IIFP site. The following sections describe each of these conveyances, associated routes, and the dose contribution to the public and worker.

4.2.6.1 Transportation Modes, Routes, and Distances

The DUF₆ feed materials for the facility will be transported by truck via highway travel only. A main source of the DUF₆ feed material is expected to come from the Louisiana Enrichment Services (LES), National Enrichment Facility (NEF) near Eunice, New Mexico. The distance between the IIFP Facility and the NEF is 33 km (20 mi). The primary transportation route between the site and the depleted UF₆ feed from the NEF will be via NM 234 and NM 8 then U.S. 62/180.

Additionally, DUF₆ feed could come from the Global Laser Enrichment (GLE) facility to be built in Wilmington, NC. The GLE facility is presently seeking a license to enrich UF₆ using an advanced technology. Wilmington, NC is 2,350 km (1,460 mi) from Hobbs. The primary route from Wilmington to Hobbs is as follows: U.S.76 to Whitefield, NC; U.S.74 to I-95 south of Lumberton, NC; I-95 to I-20 prior to Columbia; SC, I-20 through South Carolina, Georgia, Alabama, Mississippi, and Louisiana to Big Spring, Texas; U.S. 87 to Lamesa, TX; then U.S. 180 to Hobbs.

DUF₆ feed could come from the AREVA facility near Eagle Falls, ID at a distance of 1,421 km (883 mi). For shipments from the AREVA facility, the primary route would be I-15 to Salt Lake City, UT; I-80 to Cheyenne, WY; I-25 to Las Vegas, NV; US -84 to Melrose, NM; NM 263/3 to Portales, NM; NM 206 to Lovington, NM; then NM 483 to the IIFP Site.

Additional DUF₆ feed could come from the Paducah USEC facility at a distance of 1415 km (879 mi) or from the USEC's American Centrifuge Facility near Piketon, Ohio at a distance of 1,950 km (1,250 miles). For shipments from the Paducah facility, the primary route would use US 60 to Cairo, IL; I-55 to Memphis, TN; I-40 to Little Rock, AR; I-30 and I-20 to Dallas, TX; I-20 to Big Springs, TX; US 87 to Lamesa, TX; then US 180 to Hobbs. For shipment from Piketon, OH, take US 35 to Dayton, OH; I-75N to Toledo, OH; I-70 to St. Louis, MO; I-44 Oklahoma City, OK; I-40 to I-40/I-27 to Lubbock, TX; US 62/82 to US 62/180 to the IIFP Site.

ER Section 3.12.2.2, "Radioactive and Mixed Wastes," describes the various radioactive waste types that will be generated by IIFP operations. All solid radioactive wastes generated will be Class A low-level wastes. One low-level waste disposal site that is likely to be used to process or dispose of IIFP radioactive or mixed waste is the Energy Solutions facility in Clive, Utah. The Clive site is owned and operated by Energy Solutions of Utah. Currently, the license allows acceptance of Class A waste only. In addition to accepting radioactive waste, the Clive facility may accept some mixed wastes. This facility is licensed to accept IIFP low-level waste either directly from the IIFP site or as processed waste from off-site waste processing vendors. The disposal site is approximately 1,636 km (1,016 mi) from the IIFP facility. The route to the Clive facility is as follows: take NM 483 to Lovington, then follow NM 206 N to Portales, then NM 267 to Melrose, then U.S. 84/U.S. 60 to Fort Sumner, then continue to follow U.S. 84 to I-40 near Santa Rosa west toward Las Vegas. Continue on I-40 through Colorado, entering Wyoming. Merge onto I-80 toward Laramie, entering Utah. Take exit 49 at Clive, Utah.

Waste Control Specialists (WCS) near Eunice currently owns and operates a RCRA/TSCA landfill and provides treatment and storage services for hazardous and mixed low-level radioactive wastes. WCS currently cannot receive and dispose of the IIFP uranium oxide wastes. The distance from WCS is approximately 33 km (20 mi). From the site, take NM 483 south to U.S. 62/180, then east toward Hobbs.

Take NM 8 south to NM 176. Take NM 176 east through Eunice and past the New Mexico/Texas border to the access road to WCS.

4.2.6.2 Radioactive Treatment and Packaging Procedure

Specific handling of radioactive and mixed wastes is discussed in detail in ER Section 3.12, "Waste Management." Packaging of product material, radioactive waste and mixed waste will be in accordance with plant implementation procedures that follow 10 CFR 71 (CFR, 2009m) and 49 CFR 171-173 (CFR, 2009hh; CFR, 2009ii). Depleted UF₆ shipments will have additional packaging controls in accordance with ANSI N14.1 (ANSI, 2001). Waste materials will have additional packaging controls in accordance with each respective disposal or processing site's acceptance criteria (CFR, 2009m).

4.2.6.3 Incident-Free Scenario Radiological Dose

Incident-free transport means that the radioactive material is transported without a traffic accident or other incident resulting in no release of radioactive material to the environment. The radiological dose a person is exposed to as a result of materials being transported incident-free to and from the Proposed IIFP Facility is dependent on several factors, including the external radiation levels of the package being transported, distance from the package to the exposed individual, exposure time per shipment, and number of shipments individuals are exposed to over a time period (i.e., shipments per year).

The radiological dose equivalents from incident-free transportation for categories of shipping are presented in Table 4-4, "Incident-Free Transportation Dose to the Public and Worker." Each shipment category represents the various material shipments to and from the IIFP site. Within each category, radioactive material may be shipped to different locations. For calculation purposes, the worst-case dose equivalent was calculated and showed SMALL impact. The collective dose equivalent to the general public from the worst case (highest dose) route in each shipping category (waste and DUF₆) totaled 1.50E-06 person-Sv/year (1.50E-04 person-rem/year). Similarly, the dose equivalent to the onlooker, driver and worker were 8.19E-03, 9.50E-01, 3.09E-08 person-Sv/year (8.19E-01, 9.50E+00, 3.09E-06 person-rem/year), respectively.

The cumulative dose equivalent to the general public from transportation of DUF₆ and solid waste was based on the model in NUREG/CR-0130 (NRC, 1978), which in turn was based on WASH-1238. NUREG/CR-0130 (NRC, 1978) defines the dose to the general public resulting from the transportation of radioactive materials as equal to 1.2E-07/person/Sv/km (1.9E-05 person-rem/mile), based on several demographic variables. This dose equivalent per distance was corrected for each route to or from the IIFP site. The 2000 census demographics information was proportioned to each route, resulting in a correlated dose equivalent to the general public, while still employing the same assumption in NUREG/CR-0130 (NRC, 1978) and WASH-1238.

Additionally, the routine transportation impacts involving UF₆ shipments are consistent with the findings of a prior EIS of NRC, NUREG-0170, "Final Environmental Statement on the Transportation of Radioactive Material by Air and Other Modes" (NRC, 1977a). The analysis in this NRC EIS concluded that "the average radiation dose to the population at risk from normal transportation is a small fraction of the limits recommended for members of the public from all sources of radiation other than natural and medical sources and is a small fraction of natural background doses" (NRC, 1977a). Routine transportation shipments from the IIFP facility are expected to be no greater than the conclusions drawn in the NRC EIS.

Table 4- 4 Annual Incident-Free Transportation Radiological Dose to the Public and Worker

Facility	Description	Number of Shipments	Distance (km)	Dose Equivalent to General Public ¹		Dose Equivalent to On-lookers ²		Dose Equivalent to Drivers ³		Dose Equivalent to Garage Personnel ⁴	
				Person-Sv	Person-rem	Person-Sv	Person-rem	Person-Sv	Person-rem	Person-Sv	Person-rem
NEF, Eunice, NM	Full DUF ₆ Cylinders	789	56	1.41E-08	1.41E-06	2.70E-03	2.70E-01	9.31E-03	9.31E-01	6.17E-09	6.17E-07
USEC, Paducah, KY	Full DUF ₆ Cylinders	789	1415	4.06E-07	4.06E-05	2.70E-03	2.70E-01	2.35E-01	2.35E+01	6.17E-09	6.17E-07
USEC, Piketon, OH	Full DUF ₆ Cylinders	789	1950	7.15E-07	7.15E-05	2.70E-03	2.70E-01	3.24E-01	3.24E+01	6.17E-09	6.17E-07
GLE, Wilmington, NC	Full DUF ₆ Cylinders	789	2350	5.91E-07	5.91E-05	2.70E-03	2.70E-01	3.91E-01	3.91E+01	6.17E-09	6.17E-07
NEF, Eunice, NM	Empty DUF ₆ Cylinders	789	56	1.41E-08	1.41E-06	5.40E-03	5.40E-01	9.31E-03	9.31E-01	2.47E-08	2.47E-06
USEC, Paducah, KY	Empty DUF ₆ Cylinders	789	1415	4.06E-07	4.06E-05	5.40E-03	5.40E-01	2.35E-01	2.35E+01	2.47E-08	2.47E-06
USEC, Piketon, OH	Empty DUF ₆ Cylinders	789	1950	7.15E-07	7.15E-05	5.40E-03	5.40E-01	3.24E-01	3.24E+01	2.47E-08	2.47E-06
GLE, Wilmington, NC	Empty DUF ₆ Cylinders	789	2350	5.91E-07	5.91E-05	5.40E-03	5.40E-01	3.91E-01	3.91E+01	2.47E-08	2.47E-06
Energy Solutions, Clive, UT	Uranium Oxide and Misc LLW Waste	450	1636	1.63E-08	1.63E-06	8.10E-05	8.10E-03	1.55E-01	1.55E+01	9.72E-12	9.72E-10
WCS, Eunice, NM	Uranium Oxide and Misc LLW Waste	450	56	8.04E-09	8.04E-07	8.10E-05	8.10E-03	5.31E-03	5.31E-01	9.72E-12	9.72E-10
GTS Duratek, Oak Ridge, TN	Uranium Oxide and Misc LLW Waste	450	1776	6.77E-08	6.77E-06	8.10E-05	8.10E-03	1.68E-01	1.68E+01	9.72E-12	9.72E-10

¹Collective dose equivalent based on population density along route

²Collective dose equivalent to onlookers was calculated by multiplying the dose equivalent rate at 2 m (6.6 ft) on side from the container, times 3 minutes, times 10 people exposed to each container, times number of shipments.

³Collective dose equivalent based on two truck drivers per shipment

⁴Collective dose equivalent to garage personnel was calculated by multiplying the dose equivalent rate at 2 m (6.6 ft) on side from the container, times 10 minutes, times two garage personnel exposed, times the number of shipments

4.2.6.4 Environmental Impacts from Severe Transportation Accidents of Radioactive Material

Evaluation of Radiological Impacts of Transportation Accidents Involving DUF₆

The Department of Energy evaluated the radiological consequences of a severe transportation accident involving DUF₆ (DOE, 2004a), (DOE, 2004b). These accidents are characterized by extreme mechanical and thermal forces, and accidents of this severity will be expected to be extremely rare (Biwer et al., 2001). Because DOE postulated a hypothetical accident that could occur at any location, the results are not route-dependent. DOE evaluated the radiological consequences to people in rural areas [6 persons/km² (15 persons/mi²)], suburban areas [719 persons/km² (1,798 persons/mi²)], and urban areas [1,600 persons/km² (4,000/persons mi²)]. Radiation doses were estimated under neutral atmospheric conditions [Stability Class D with a wind speed of 14 km/hr (9 mi/hr)] and stable atmospheric conditions [Stability Class F with a wind speed of 3.5 km/hr (2.2 mi/hr)].

Table 4-5 presents the radionuclide inventory of uranium cylinders. Table 4-6 and Table 4-7 list the radiological consequences of these severe transportation accidents based on the radionuclide inventories.

For a severe truck accident involving one cylinder of DUF₆, the population radiation dose could be as high as 32,000- person-rem in an urban area, if stable atmospheric conditions exist at the time of the accident. Based on this population radiation dose, it was estimated that there could be 20 Latent Cancer Fatalities (LCF) in the exposed population of about 3 million people. For comparison, in a population of 3 million people, approximately 700,000 will be expected to die from cancer of all causes. The radiation dose for the Maximum Exposed Individual (MEI) was estimated to be as high as 0.91 rem if stable atmospheric conditions existed at the time of the accident. The probability of a LCF for this individual was estimated to be 0.0005.

Table 4- 5 Radionuclide Inventory of Uranium Cylinders

Material	²³⁴ U Inventory (Ci)	²³⁵ U Inventory (Ci)	²³⁸ U Inventory (Ci)
DU Feed ^a	1.1	0.064	2.8
DU Tails ^b	0.50	0.037	2.8

Source: DOE (2004a, 2004b)

^aDU feed has a range of enrichments from 0.35 to less than 0.711 weight percent ²³⁵U. In this analysis the DU feed enrichment was assumed to be 0.35 weight percent ²³⁵U, which maximizes the amount of DU tails.

^bDU tails assumed to be 0.2 weight percent ²³⁵U.

Based on an equivalent number of operating years for the facilities, the IIFP accident consequence assessment for radiological impacts to the population from severe truck transportation accidents are expected to be no greater than the results presented in the DOE EIS for DUF₆, depleted uranium oxides and heel cylinders (See Table 4-6).

Table 4- 6 Potential Radiological Consequences for the Population from Severe Transportation Accidents^a

Mode	Neutral Meterological Conditions			Stable Meterological Conditions		
	Rural ^b	Suburban	Urban ^b	Rural ^b	Suburban	Urban ^b
DUF₆ Radiological Dose (person-rem)						
Truck	590	580	1,300	15,000	15,000	32,000
Depleted U₃O₈ (in bulk bags) Radiological Dose (person-rem)						
Truck	250	250	550	630	610	1,400
Depleted U₃O₈ (1 cylinder) Radiological Dose (person-rem)						
Truck	120	110	250	280	280	620
Heel cylinders^c Radiological Dose (person-rem)						
Truck	0.25	0.067	0.15	0.44	0.12	0.26
DUF₆ Radiological Risk (LCF)^c						
Truck	0.4	0.3	0.8	7	7	20
Depleted U₃O₈ (in bulk bags) Radiological Risk (LCF)^d						
Truck	0.1	0.1	0.3	0.3	0.3	0.7
Depleted U₃O₈ (1 cylinder) Radiological Risk (LCF)^d						
Truck	0.06	0.06	0.1	0.1	0.1	0.3
Heel Cylinders^c Radiological Risk (LCF)^d						
Truck	0.0001	3 x 10 ⁻⁵	7 x 10 ⁻⁵	0.0002	6 x 10 ⁻⁵	0.0001

Source: DOE (2004a, 2004b).

^a National average population densities were used for the accident consequence assessment, corresponding to densities of 6 person/km², 719 persons/km², and 1,600 person/km², for rural, suburban, and urban zones, respectively. Potential impacts were estimated for the population with a 50-mi (80-km) radius, assuming a uniform population density for each zone.

^b It is important to note that the urban population density generally applies to a relatively small urbanized area—very few, if any urban areas have a population density as high as 1,600 person/km², extending as far as 50-mi (80-km). The urban population density corresponds to approximately 32 million people within the 50-mi (80 km) radius, well in excess of the total populations along the routes considered in the assessment.

^c Cylinders assumed not to meet waste acceptance criteria for Envirocare. Shipped “as-is”, one per truck.

^d LCF’s were calculated by multiplying the dose by the ICRP Publication 60 health risk factors of 4 x 10⁻⁴ fatal cancers per person-rem for workers and 5 x 10⁻⁴ for the public (ICRP, 1991).

Table 4- 7 Radiological Consequences for the Maximally Exposed Individual from Severe Transportation Accidents Involving Depleted Uranium Hexafluoride

Mode	Neutral Atmospheric Conditions		Stable Atmospheric Conditions	
	Dose (rem)	Probability of LCF ^a	Dose (rem)	Probability of LCF ^a
Truck	0.43	0.0003	0.91	0.0005

Source: DOE (2004a, 2004b)

^aLCFs (latent cancer fatalities) are calculated by multiplying the radiation dose by the health risk conversion factor of 0.0006 fatal cancers per person-rem

Based on an equivalent number of operating years for the facilities, the IIFP radiological consequences for the Maximally Exposed Individual (MEI) from severe truck transportation accidents involving DUF₆ are expected to be no greater than the results presented in the DOE EIS summarized in Table 4-7 above.

Evaluation of Chemical Impacts of Transportation Accidents Involving DUF₆

The DOE studies also evaluated the chemical consequences of a transportation accident involving UF₆ (2004a, 2004b). If UF₆ is released to the atmosphere, it reacts with water vapor in the air to form HF an

UO₂F₂, independent of the enrichment of the UF₆ (i.e., natural, enriched, or depleted). The products are chemically toxic to humans. HF is extremely corrosive; it can damage the lungs and cause death if inhaled at high enough concentrations. In addition, uranium is a heavy metal that, in addition to being radioactive, can have toxic chemical effects (primarily on the kidneys) if it enters the body by way of ingestion and/or inhalation.

Because DOE postulated a hypothetical accident that could occur at any location, the results are not route-dependent. DOE evaluated chemical impacts to rural areas [6 persons/km² (15 persons/mi²)], suburban areas [719 persons/km² (1,798 persons/mi²)], and urban areas [1,600 persons/km² (4,000 persons/mi²)]. Chemical impacts depend only on the amount of DUF₆ in the container and not on the enrichment of the uranium.

The toxic effects, or chemical impacts, can be categorized as adverse health effects or irreversible adverse health effects. An adverse health effect includes respiratory irritation or skin rash associated with lower chemical concentrations. An irreversible adverse health effect generally occurs at higher chemical concentrations and is permanent in nature. Irreversible adverse health effects include death, impaired organ function (such as central nervous system or lung damage), and other effects that may impair daily functions. Of those individuals receiving an irreversible adverse health effect, approximately 1% or less will die from it.

Table 4-8 and Table 4-9 list the chemical consequences of these severe transportation accidents. The consequences of such an accident (worst-case scenario) were estimated on the basis of the assumption that the accident occurred in an urban area under stable atmosphere conditions (such as at night-time) when there is less dispersion of released material than during neutral atmospheric conditions. In such a case, it was estimated that approximately four persons might experience irreversible adverse effects (such as lung or kidney damage) from exposure to HF and uranium. The number of fatalities expected following an HF or uranium chemical exposure is expected to be somewhat less than 1% of those persons experiencing irreversible adverse effects. See Table 4-9. Thus, no fatalities will be expected (1% of 4).

Table 4- 8 Chemical Consequences for the Population from Severe Transportation Accidents Involving Depleted Uranium Hexafluoride^a

Mode	Neutral Atmospheric Conditions			Stable Atmospheric Conditions		
	Rural	Suburban	Urban ^b	Rural	Suburban	Urban ^b
Number of People with the Potential for Adverse Health Effects						
Truck	0	2	4	6	760	1,700
Number of People with the Potential for Irreversible Health Effects^c						
Truck	0	1	2	0	1	3

Source: DOE (2004a, 2004b).

^aNational average population densities were used for the accident consequences assessment, corresponding to densities of 6 persons/km² for rural zones, 719 persons/km² for suburban zones, and 1,600 persons/km² for urban zones. Potential impacts were estimated for the population within a 50-mi (80-km) radius, assuming a uniform population density for each zone.

^bIt is important to note that the urban population density generally applies to relatively small urbanized area-very few, if any, urban areas have a population density as high as 1,600 persons/km² extending as far as 80 km (50 mi). That urban population density corresponds to approximately 32 million people within the 50 mile radius, well in excess of the total populations along the routes considered in this assessment.

^cExposure to HF or uranium compounds is estimated to result in fatality to approximately 1% or less of those persons experiencing irreversible adverse effects.

Based on an equivalent number of operating years for the facilities, the IIFP accident consequence assessment for chemical impacts from severe transportation accidents involving DUF₆ are expected to be no greater than the results presented in the DOE EIS. (See Table 4-8).

Table 4- 9 Chemical Consequences for the Maximally Exposed Individual from Severe Transportation Accidents Involving Depleted Uranium Hexafluoride

Mode	Neutral Atmospheric Conditions		Stable Atmospheric Conditions	
	Adverse Effects	Irreversible Adverse Effects	Adverse Effects	Irreversible Adverse Effects
Truck	Yes	Yes	Yes	Yes

Source: DOE (2004a, 2004b)

aExposure to HF or uranium compounds is estimated to result in fatality to approximately 1% or less of those persons experiencing irreversible adverse effects.

Based on an equivalent number of operating years for the facilities, the IIFP radiological consequences for the Maximally Exposed Individual (MEI) from severe truck transportation accidents involving DUF₆ are expected to be no greater than the results presented in the DOE EIS summarized in Table 4-8 and 4-9 above.

4.2.7 Cumulative Impacts

The pre-licensing and general construction, operation, and decommissioning of the Proposed IIFP Facility will result in an incremental increase in the daily vehicle trips on NM 483, U.S. 62/180, and the other connecting roadways in the vicinity of the facility. However, the transportation impacts resulting from these traffic increases will not be cumulative over the pre-licensing and general construction, operation, and decommissioning phases of the Proposed Action.

The increased automobile and truck traffic associated with the Proposed IIFP Facility will increase motor vehicle air emissions and traffic noise in the vicinity of the site. Air emissions and noise impacts from the motor vehicle traffic accessing the Proposed IIFP Facility are discussed in Section 4.6, “Air Quality Impacts,” and Section 4.7, “Noise Impacts,” respectively.

The impact of the cumulative daily vehicle trips that will be generated by the Proposed IIFP Facility on traffic flow on the segment of U.S. 62/180 in the immediate vicinity of the Arkansas Junction is anticipated to be SMALL. However, the impact of cumulative daily vehicle trips on NM 483 is anticipated to be MODERATE. On a regional basis, the cumulative transportation impacts for the Proposed IIFP Facility are expected to be SMALL.

The cumulative routine transportation are determined to be SMALL as described in Section 4.2.6.3. The cumulative radiological or chemical (DUF₆) impacts of severe transportation accidents shipments are expected to be no greater than those evaluated in prior DOE and NRC Environmental Impact Statements as described and cited above.

Similarly, the NRC has evaluated the environmental impacts resulting from the transport of nuclear materials in NUREG-0170, “Final Environmental Statement on the Transportation of Radioactive Material by Air and Other Modes” (NRC, 1977a), and updated by NUREG/CR-4829, “Shipping Container Response to Severe Highway and Railway Accident Conditions” (NRC, 1987a). These references include accident scenarios related to the transportation of radioactive material. The NRC found that these accidents have no significant environmental impacts (NRC, 1977a; NRC 1987a).

4.2.8 Impact Controls

Control measures that can be used to mitigate the motor vehicle traffic impacts on U.S. 62/180 and NM 483 in the immediate vicinity of the IIFP facility with the connecting roads to the other communities due to the pre-licensing and general construction, operation, and decommissioning of the Proposed IIFP Facility include the following:

- Schedule Proposed IIFP Facility operations worker shift changes and truck shipments for off-peak traffic periods, when practical.
- Install a traffic light at the site entrance on NM 483.

4.2.9 Comparative Transportation Impacts of Alternative Actions

ER Chapter 2 provides a discussion of possible alternatives to the construction and operation of the IIFP facility, including an alternative of "No-Action," i.e., not building the IIFP facility. Additionally, IIFP considered reasonable alternatives using alternative technologies for de-conversion services and production of fluorine products.

4.2.9.1 No-Action Alternative

The DOE de-conversion facilities are sized and built to dispose of the DOE DUF₆ inventory. The de-conversion and disposal is expected to take 20 to 25 years. If DOE were to process privately owned DUF₆, de-conversion would likely have to await completion of the DOE mission or DOE would have to add additional capacity to their plants. A 20 to 25 year delay in processing the DUF₆ would force private enrichment companies to store tails on site or to build or use their own de-conversion facilities.

Transportation of DUF₆ cylinders from the NEF to de-convert at either DOE site will be considerably further by 1,415 km (879 mi) to Paducah or 1,950 km (1,212 mi) to Piketon. Transportation of DUF₆ cylinders from the GLE will be somewhat shorter distances. See Section 2.7.1.2, "Environmental Impacts for Transportation of Radioactive Material," for the transportation impact of this No-Action Alternative.

4.2.9.2 Reasonable Alternate Actions

One of the Reasonable Alternatives considered the utilization of the alternate DOE de-conversion technology on the Proposed IIFP Site near Hobbs, New Mexico. This alternative technology is the same as that which will be used in the de-conversion process utilized at the DOE sites at Paducah, KY and Piketon, Ohio. With this DOE technology, UF₆ reacts with water and hydrogen to produce uranium oxide, which must be disposed of as waste in a licensed facility, and aqueous HF that has a lower market value than AHF. In this case, treatment facilities would be required, and the treatment could result in generation of large amounts of materials for disposal. The transportation impacts for this scenario will be greater than the impacts of the Proposed Action due to the shipment of wastes generated by the neutralization of aqueous HF.

Two of the enrichment companies have de-conversion facilities overseas and could choose to ship their DUF₆ from the U.S. to those facilities for de-conversion. Those companies that do have existing overseas facilities and technologies would be required to ship DUF₆ overseas long-distances and may have to return the waste oxides to United States for licensed disposal or may have to arrange with other countries for disposal. It is expected that transportation impacts for this option of shipping the DUF₆ overseas may be greater than the Proposed Action.

The four enrichment companies could decide to build and operate their own de-conversion facilities in the U.S. If those companies were to build new facilities to de-convert “tails” material, it is expected that the transportation impacts for this Reasonable Alternative are expected to be similar than the Proposed Action at another site.

For the environmental impacts on transportation should the enrichment companies utilize existing DOE de-conversion facilities, see Section 4.2.9.1.

4.3 Geology and Soil Impacts

Site geology and soils are fully described in the ER Section 3.3. The sections below address the impacts of the Proposed Action on site geology and soils.

4.3.1 Geology Impacts

As indicated in Section 3.3, the IIFP site in Lea County, NM is located near the edge of High Plains, also called the Llano Estacado. The High Plains are capped by a thick layer of caliche, locally known as the Caprock that extends throughout northern Lea County. The caprock was formed when surface drying caused mineral-laden water to rise by capillary action to the surface. Evaporating, the minerals were left behind to cement the otherwise loose sandy sediments of the Ogallala Group. The caprock is generally covered by sands and soils. The shallow geological conditions will not create any significant impacts on site preparation and construction of the facility. The seismicity at the site is relatively low, but will be mitigated by incorporation of seismic criteria in the design.

4.3.2 Soils Impacts

Soils for the Hobbs site are sandy and well drained, with a well-developed caliche layer occurring at the surface or as shallow as 25 to 30 cm (10 in to 12 in) below the surface in some areas of the site. Caliche refers to a buff, white, or reddish brown calcareous material commonly found in layers on or near the surface of soils in arid regions. No soil sample borings are available for this site; however, the deposit of caliche cap across the site is expected to occur in a thickness range of 2.4 to 7.6 m (8 to 25 ft). The Hobbs site has a caliche rock layer that will have to be negotiated for civil construction work. The site is nearly flat with a slight slope that accommodates drainage.

Foundation conditions at the site are generally good and no potential for mineral development exists or has been found at the site. Construction activities may cause some short-term increases in soil erosion at the site, although rainfall in the region is limited. Erosion impacts due to site clearing and grading will be mitigated by utilization of construction and erosion control BMPs. (See ER Section 4.1, “Land Use Impacts,” for a discussion of construction BMPs and a list of potential pre-licensing construction tasks.) Disturbed soils will be stabilized as part of construction work. Earth berms, dikes and sediment fences will be utilized as necessary during all phases of construction to limit runoff. Much of the excavated areas will be covered by structures or paved, limiting the creation of new dust sources. Watering will be used to control potentially fugitive construction dust. Water conservation will be considered when deciding how often dust suppression sprays will be applied. Pre-licensing construction tasks conducted prior to NRC approval of the license for the Phase 1 facility will be preparatory in nature and will not involve any process or safety related equipment or systems. The pre-licensing construction activities only affect the timing of work and will not increase the scope or environmental impact of facility construction.

4.3.3 Site Preparation and Construction

Pre-licensing and general construction activities that will disturb the shallow site soils are anticipated to include stripping of topsoil within the 16.2-ha (40-ac) IIFP Facility Site; excavation of soils for a stormwater retention basins; backfill, compaction, and grading activities for parking areas and buildings; and shallow and/or deep foundation installations for buildings. Additionally, construction of the proposed access road will be included within the 259-ha (640-ac) buffer area.

The engineering design will specify the volume of soils that will be impacted during the construction phases. At this time, it is assumed that any shallow soils disturbed or moved during facility construction will be reused within the 16.2-ha (40-ac) Site. No off-site disposal of soil is expected.

4.3.4 Road Construction at the Proposed Site

The access road from NM 483 (Arkansas Junction Road) to the Proposed IIFP Facility will cross several different soil types, as outlined on the soil type map shown in Figure 3-24, "Custom Soil Resource Report Soil Map of the IIFP Site." The topsoil will likely need to be stripped before road construction can begin, and the remaining shallow soils that are considered suitable for a roadbed will need to be compacted. The resulting increase in impervious area will impact the volume of runoff from the land surface, but the amount of topsoil or sediment available for transport as erosion will be decreased. Roadbed preparations will have a SMALL impact on the site soils.

4.3.5 Grading within the IIFP Site

The grading within the IIFP facility site will begin with the removal of topsoil from areas designated for the new construction. The topsoil thickness to be removed will be determined by the soil test borings performed as part of the preliminary subsurface investigation. Following removal of topsoil, those areas at grade or designated to receive fill will likely be proof-rolled to identify those areas needing additional soil repair. Any area that ruts or bumps appear excessively in the opinion of the geotechnical engineer will be undercut to firm bearing or be repaired, as directed by the engineer.

4.3.6 Operations

Impacts to shallow soils after construction is complete and during Proposed IIFP Facility operation are SMALL. The stormwater retention basins within the 16.2-ha (40-ac) IIFP Facility Site will manage stormwater runoff up to a 100-year return period event. Operation of the Proposed IIFP Facility will not involve additional soil disturbances; therefore, additional areas susceptible to soil erosion and dust generation will not be created.

4.3.7 Decommissioning

Decommissioning of the Proposed IIFP Facility will involve removal of internal structures, utilities, and products from the building; however, the physical structure, associated foundations, access roads, and utility lines will likely remain intact. Soil testing will demonstrate that residual soils meet NRC and EPA guidelines for free release. Impacts to shallow soils are expected to be SMALL upon completion of the decommissioning process.

4.3.8 Cumulative Impacts to Site Soils

Approximately 16.2 ha (40 ac) of land will be disturbed during the development of this project. During construction, shallow soils will be disturbed for the construction of building footings and the excavation of stormwater retention basins; however, as with the Proposed Action, measures will be taken to ensure that the impacts will be minimized as indicated in Section 4.3.9. Also, there will be an increase in stormwater runoff and a decrease in erosion due to conversion of vegetated lands to impervious surfaces. These impacts will be mitigated by the designated retention basins. Cumulative shallow soils impacts from the Proposed Action are SMALL.

4.3.9 Impact Controls

The practices and measures used to control soil impacts during construction include the following:

- Best management practices (BMPs) to control soil and sediment migration. These BMPs are further described in Sections 4.4.7, "Control of Impacts to Water Quality," and Chapter 5.0, "Mitigation Measures."
- Engineering design plans that minimize soil disturbance during construction activities.
- Use of soils from on-site borrow pits, if necessary for construction purposes, that are accessible via existing roadbeds to minimize disturbance to other areas of the site.
- Management of construction activities so that only designated areas within the 16.2-ha (40-ac) Site are disturbed and so that no heavy equipment or construction operations are allowed to affect areas outside the 16.2 ha (40 ac) unless specifically designated, such as potential use of existing on-site borrow areas.
- Establishment and implementation of an approved Decommissioning Plan for ultimate NRC release of the site for unrestricted use and license termination.

4.3.10 Comparative Geology and Soil Impacts of Alternative Actions

ER Chapter 2 provides a discussion of possible alternatives to the construction and operation of the IIFP facility, including an alternative of "No-Action," i.e., not building the IIFP facility. Additionally, IIFP considered reasonable alternatives using alternative technologies for de-conversion services and production of fluorine products.

4.3.10.1 No-Action Alternative

The DOE de-conversion facilities are sized and built to dispose of the DOE DUF₆ inventory. The de-conversion and disposal is expected to take 20 to 25 years. If DOE were to process privately owned DUF₆, de-conversion would likely have to await completion of the DOE mission or DOE would have to add additional capacity to their plants. A 20 to 25 year delay in processing the DUF₆ would force private enrichment facilities to store tails on site or to build or use their own de-conversion facilities.

The No-Action Alternative of long-term storage of DUF₆ would impact geology and soil at the enrichment facilities due to the construction of storage facilities and may present potential unnecessary risk to the public. If DOE were to expand its facilities for additional capacity, additional geology and soil impacts will be incurred at Paducah, KY and/or Piketon, OH

4.3.10.2 Reasonable Alternative Actions

One of the Reasonable Alternatives considered the utilization of the alternate DOE de-conversion technology on the Proposed IIFP Site near Hobbs, New Mexico. This alternative technology is the same as that which will be used in the de-conversion process utilized at the DOE sites at Paducah, KY and Piketon, Ohio. With this DOE technology, UF_6 reacts with water and hydrogen to produce uranium oxide, which must be disposed of as waste in a licensed facility, and aqueous HF that has a lower market value than AHF. The geology and soil impacts of this alternative are potentially greater in the event that relatively large amounts of aqueous HF cannot be sold. In this case, treatment facilities would be required to neutralize the aqueous HF, and the treatment could result in generation of large amounts of materials for disposal. If the treated materials are not sold, then materials would have to be disposed of in a licensed facility.

Two of the enrichment companies have de-conversion facilities overseas and could choose to ship their DUF_6 from the U.S. to those facilities for de-conversion. Those companies that do have existing overseas facilities and technologies would be required to ship DUF_6 overseas long-distances and may have to return the waste oxides to United States for licensed disposal or may have to arrange with other countries for disposal. It is expected that geology and soil impacts for this option of shipping the DUF_6 overseas may be similar to the Proposed Action.

The four enrichment companies could decide to build and operate their own de-conversion facilities in the U.S. If those companies were to build new facilities to de-convert “tails” material, it is expected that the geology and soils impacts for this Reasonable Alternative are expected to be similar to the Proposed Action.

See Section 4.3.10.1 for the environmental impacts on geology and soil should the enrichment companies utilize existing DOE de-conversion facilities.

4.4 Water Resources Impacts

Surface water resources at the site are minimal. There are a few local shallow playas on the site with a small stream that runs from the northwest to the southeast across the 959-ha (2,369-ac) Section. Both the playas and the stream are predominantly dry during the year. The site sits upon the Ogallala Aquifer where groundwater resources are at depths greater than approximately 37 m (120 ft). The site region has semi-arid climate, with low precipitation rates and minimal surface water occurrence. Thus, the potential for negative impacts on surface water resources are very low due to lack of water presence and formidable natural barriers to any surface or subsurface water occurrences. Groundwater at the site will not likely be impacted by any potential releases.

Permits related to water must be obtained for pre-licensing and site construction and IIFP operation are described in ER Section 1.5, “Building Permits and Licenses.” The purpose of these permits is to address the various potential impacts on water and provide mitigation as needed to maintain state water quality standards and avoid any degradation to water resources at or near the site. These permits include:

- A National Pollutant Discharge Elimination System (NPDES) General Permit for Industrial Stormwater: This permit is required for point source discharge of stormwater runoff from industrial or commercial facilities to the waters of the state. All new and existing point source industrial stormwater discharges associated with industrial activity require a NPDES Stormwater Permit from the EPA Region 6 and an oversight review by the New Mexico Water Quality Bureau (NMWQB). IIFP is eligible to claim the “No Exposure” exclusion for industrial activity

of the NPDES storm water Phase 11 regulations. As such, IIFP will submit a No Exposure Certification immediately prior to initiating operational activities at the IIFP site. IIFP also has the option of filing for coverage under the Multi-Section General Permit (MSGP) because the IIFP facility is one of the 11 eligible industry categories. If this option is chosen, IIFP will file a Notice of Intent (NOI) with the EPA, Washington, D.C., at least two days prior to the initiation of IIFP operations. A decision regarding which option is appropriate for the IIFP site will be made in the future.

- NPDES General Permit for Construction Stormwater: Because construction of the IIFP facility will involve the disturbance of more than 0.4 ha (1 ac) of land [disturbance of about 16.2 ha (40 ac) will be required for the construction phases of the project], an NPDES Construction General Permit from the EPA Region 6 and an oversight review by the New Mexico Water Quality Bureau (NMWQB) are required. IIFP will develop a Stormwater Pollution Prevention Plan (SWPPP) and file a NOI with the EPA, Washington, D.C., at least two days prior to the commencement of construction activities. This permit will be required prior to initiation of any pre-licensing construction activities as described in Section 4.1, "Land Use Impacts."
- Section 401 Certification: Under Section 401 of the *Federal Clean Water Act*, states can review and approve, condition, or deny all federal permits or licenses that might result in a discharge to State waters, including wetlands. A 401 certification confirms compliance with the State water quality standards. Activities that require a 401 certification include Section 404 permits issued by the U. S. Army Corp of Engineers (USACE). The State of New Mexico has a cooperative agreement and joint application process with the USACE relating to 404 permits and 401 certifications.

IIFP site design addresses:

- Discharge of stormwater to a site retention (evaporation) basins.
- Sanitary waste treatment system design and construction.
- Both pre-licensing and general construction activities.
- Recycle of process wastewater and cooling water.

Collection and discharge of stormwater runoff will be made to the Site Stormwater Retention (Evaporation) Basins. These basins are described in ER Section 3.4.1.2, "Facility Withdrawals and/or Discharges to Hydrological Systems." The basins are designed to contain the runoff expected from a 100-year return period storm and will dispose of the water by evapotranspiration.

Pre-licensing and general construction for the IIFP site will provide a short-term risk with regard to a variety of operations and constituents used in construction activities. These will be controlled by employing BMPs including control of hazardous materials and fuels. BMPs will assure stormwater runoff related to all construction activities will be detained prior to release to the surrounding land surface. BMPs will also be used for dust control associated with excavation and fill operations during construction. See ER Section 4.1, "Land Use Impacts," for more information on construction BMPs. Impact from stormwater runoff generated during plant operations is not expected to differ significantly from impacts currently experienced at the site.

The water quality of the discharge from the site stormwater retention basins overflow would be typical of runoff from building roofs and paved areas from any industrial facility. Except for small amounts of oil and grease typically found in runoff from paved roadways and parking areas, the discharge is not expected to contain contamination.

4.4.1 Receiving Waters

The IIFP facility will not obtain any surface water or discharge any process effluents onto the site or into surface waters other than into engineered evaporation basins and for on-site use. Sanitary waste water will be processed through a tertiary-treatment system and reused in the plant or for landscape watering. Rain runoff from developed portions of the site will be collected in retention basins, described previously and in ER Section 3.4, "Water Resources." There are no planned discharges from the Site Stormwater Retention Basins; levels will be managed by evapotranspiration only.

The IIFP 2,369-acre Section includes hydrologic features of several playa lakes which are dry during most of the year. Four irrigation wells have been previously drilled on the proposed site. Groundwater was encountered at depths of 15.2 to 21.4 m (55 to 70 ft) to a total depth of 50 to 60.4 m (164 to 198 ft) (EDCLC, 2008). Significant quantities of groundwater are only found at a depth of approximately 61 m (200 ft) in the Ogallala Aquifer.

Due to high evapotranspiration rates for the area, it is not anticipated that there will be any receiving waters for runoff derived from the IIFP Facility other than residual amounts from that collected in the Site Stormwater Retention Basin or the Stormwater Retention Basin at the Full DUF₆ Cylinder Storage Pad. At shallower depths vegetation at the site provides highly efficient evapotranspiration processes, as described in ER Section 3.4.1.1, "Major Surface and Subsurface Hydrological Systems." That natural process will remove the major part of stormwater runoff at the site.

The stormwater retention basins for the site are designed to provide a means of controlling discharges of rainwater for about 8.1 to 16.2 ha (20 to 40 ac) of the IIFP site. Impacts to receiving waters from pre-licensing and general construction and operation of the IIFP facility are expected to be SMALL.

4.4.2 Impacts on Surface Water and Groundwater Quality

Although quantities are severely limited, local shallow groundwater is of a minimally suitable quality to provide sources of potable water. Water for most domestic and industrial uses is expected to contain less than 1,000 mg/l Total Dissolved Solids (TDS) (Davis, 1966). This compares with an EPA secondary standard of 500 mg/l TDS (CFR, 2009t) for potable water. Therefore, treatment will be necessary.

Control of surface water runoff will be required for IIFP facility pre-licensing and general construction activities, covered by the NPDES Construction General Permit. As a result, no significant impacts are expected for either surface water bodies or groundwater. During IIFP operation, stormwater from the site will be collected in a collection system that includes two runoff retention/evaporation basins, as described in ER Section 4.4.1, "Receiving Waters." No wastes from facility operational systems will be discharged to stormwater. In addition, stormwater discharges during plant operation will be controlled by a Stormwater Pollution Prevention Plan (SWPPP). Impacts of construction activities to the surface and groundwater are expected to be SMALL.

4.4.3 Hydrological System Alterations

Excavation and placement of fill will provide the site with a finished level grade. This work will not require alteration or filling of any surface water features on the site.

No alterations to groundwater systems will occur due to pre-licensing or general facility construction. Referring to ER Section 3.4.15, since there is no consistent groundwater in the sand and travel layer above the Chinle Formation, there is not a likely contaminant pathway in a lateral or vertical direction.

Although engineered fill will be used during site preparation and will likely be placed against the existing dense sand and gravel layer in some locations, the potential for water or other liquids from spills or pipeline leaks to introduce sufficient amounts of liquid to saturate the sand and gravel layer to a point where significant contaminant migration reaches and flows along the top of the Chinle Formation, is considered unlikely. The addition of on-site fill is not expected to alter this situation. Furthermore, the travel time to downstream users through a lateral contaminant pathway will be significant since potential contamination will travel laterally at very small rates, if at all. The low permeability of the Chinle Formation clay will impede deep infiltration of water as well.

4.4.4 Hydrological System Impacts

Due to limited effluent discharge from the facility operations, the lack of groundwater in the sand and gravel layer above the Chinle Formation, and the considerable depth to groundwater at the IIFP site, the impacts are expected to be SMALL for the site's hydrologic systems.

Control of surface water runoff will be required for both pre-licensing and general construction activities, covered by the NPDES Construction General Permit. As a result, no significant impacts are expected to either surface or groundwater bodies. Control of impacts from construction runoff is discussed in ER Section 4.4.7, "Control of Impacts to Water Quality."

The volume of water discharged into the ground from the Site Stormwater Retention Basins is expected to be minimal, as evapotranspiration is expected to be the dominant natural influence on standing water.

4.4.5 Ground and Surface Water Use

Table 4-10 provides the historical water use from the Ogallala Aquifer for Lea County as reported by the Lea County Water Users Association (LCWUA). During the period from 1975 to 1985, large increases in water use occurred in most categories, with exceptions for irrigation, livestock, and power. A 13% increase in population in Lea County during this period of time may account for much of the increased water use. Above average rainfall in 1985 may account for the reported decrease in irrigated agriculture and livestock use. Water use increased in Lea County from 1985 until 1995 by 22%. Public water supply use and domestic use increased 26% and 40% respectively, even though the population of Lea County increased only 13%. The primary water use categories in 1995 were irrigated agriculture (74% of total public water supply (11% of total), mining (11% of total), and power (3% of total) (LCWUA, 1999).

Potable, process, and fire water for IIFP will be provided by two wells drilled into the Ogallala Aquifer. All potable water supply used at the IIFP facility will be treated. Average and peak site water requirements for all purposes are expected to be approximately 11.36 m³/day (3,000 gal/day) and 37.85 m³/day (10,000 gal/day), respectively. These amounts correspond to 3.4 acre-feet and 11.2 acre-feet, respectively. Impacts to water resources on the site and in the vicinity of the IIFP facility are SMALL.

4.4.6 Identification of Impacted Ground and Surface Water Users

Location of an intermittent surface water feature and irrigation wells in the site vicinity are shown on Figure 3-27, "Watercourses, Floodplains, and Playas Map." Four producing supply water wells are within the boundaries of the IIFP site as shown on Figure 4-4. Other oil production, secondary recovery, exploration, prospecting, or mining/oil water wells are located around the site.

Table 4- 10 Lea County Historical Water Use: 1977-1998

Water Use Category	Use in Acre-Feet				Change (%)		
	1975	1985	1995	1998 ^a	1975-1998	1985-1995	1995-1998 ^b
Public Water Supply	9,966	12,818	16153	17,790 ^c	+29	+26	+10
Domestic	714	949	1,331	n/a ^d	+33	+40	n/a
Irrigated Water Supply	191,290	98,409	331,163	138,601 ^e	-49	+33	+6
Livestock	1,025	727	1,497	1,111 ^f	-29	+106	-26
Commercial	555	1,111	1,346	606	+100	+21	-55
Industrial	No report	0	1,497	2,524 ^g	n/a	n/a	+69
Mining	21,612	25783	18,975	12,439 ^h	+19	-26	-34
Power	13,876	5,708	4,445	4,485	-59	-22	<1
Reservoir Evaporation	100	0	0	0	-100	0	0
Recreation	0	887	No report	966 ⁱ	n/a	n/a	n/a
Total Use	239,138	146,392	176,407	178,522	-39	+21	+1

Source: LCWUA, 1999

^aData for 1998 is incomplete. Figures are based on withdrawals from the Lea County Underground Water Basin (UWB) only.

^bActual increases and decrease for this period are yet to be determined due to incomplete NMOSE data.

^cThe value includes 1,608 ac-ft of commercial, domestic, and industrial use by the City of Carlsbad and 725 ac-ft of municipal non-cities use.

^dDomestic use has not been estimated.

^eThis figure reflects an estimated area of 83,500 acres irrigated at 1.6 ac-ft per acre plus metered irrigation at 5,001 ac-ft.

^fThis figure includes dairies and cattle feed lots, but does not include livestock use in the Jal or Capitan UWBs.

^gThis figure includes manufacturing and petroleum processing.

^hThis figure includes secondary recovery of oil, mining or ore, and oil well dwellings.

ⁱRecreation was eliminated as a separate category by the NMOSE Technical Report.

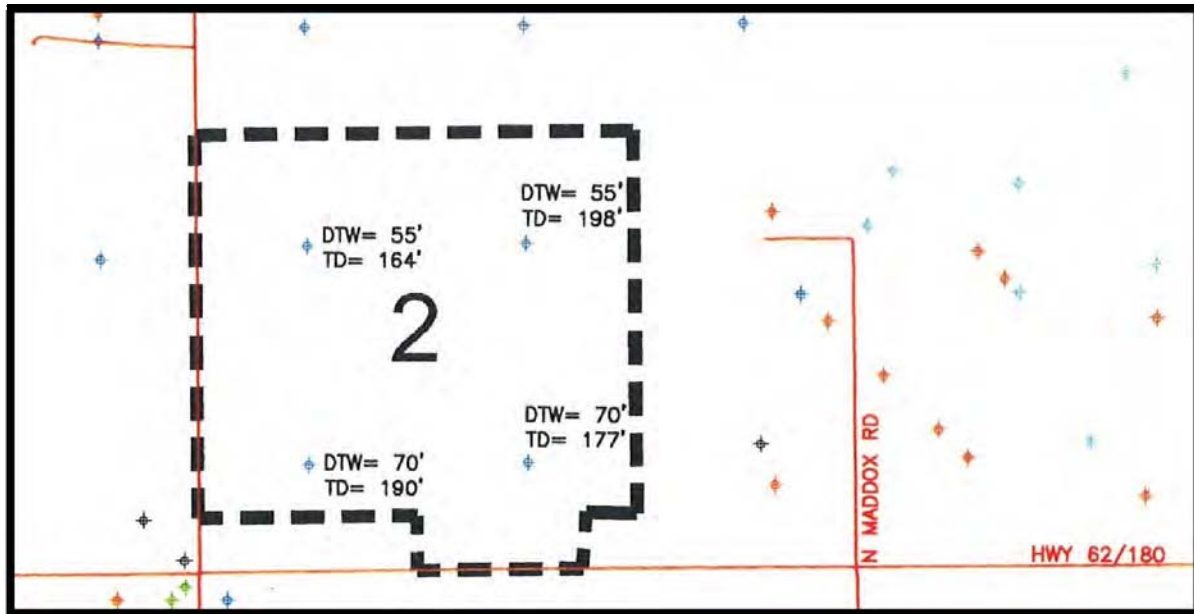

Figure 4- 4 Water Wells Located on the Proposed IIFP Site

The absence of near-surface groundwater users within 1.6 km (1 mi) from the site and the absence of surface water on the IIFP site will prevent any impact to local surface or groundwater users. Due to the lack of process water discharge from the facility to the environment, no impact is expected for these water users.

Effluent discharges will be controlled in a way that will also prevent any impacts. The location of the closest municipal water system is in Hobbs, New Mexico, 22.5 km (14 mi) east of the site. There is no potential to impact any other users. Additionally, the IIFP water usage from the aquifer will not impact other users; therefore, the impacts are SMALL.

4.4.7 Control of Impacts to Water Quality

Site runoff water quality impacts will be controlled during pre-licensing and general construction by compliance with NPDES Construction General Permit requirements and BMPs will be described in a site Storm-water Pollution Prevention (SWPP) plan.

Wastes generated during site construction will be varied, depending on activities in progress. Any hazardous wastes from construction activities will be handled and disposed of in accordance with applicable state regulations. This includes proper labeling, recycling, controlling and protected storage and shipping off site to approved disposal sites. Sanitary wastes generated at the site will be handled by portable systems until such time that the site sanitary waste treatment system is available for use.

The need to level the site for construction will require some soil excavation as well as soil fill. Fill placed on the site will provide the same characteristics as the existing natural soils thus providing the same runoff characteristics as currently exist due to the presence of natural soils on the site.

The IIFP facility stormwater runoff detention system will collect site stormwater runoff for dispersion by evapotranspiration. Spill Prevention Control and Countermeasure (SPCC) plan will be implemented for the facility to identify potential spill substances, sources and responsibilities. In addition, stormwater discharges during plant operation will be controlled by a Stormwater Pollution Prevention Plan (SWPPP) to assure that runoff released to the environment will be of acceptable water quality. These plans are described in ER Section 4.1, "Land Use Impacts."

The Stormwater Retention Basins are designed with an outlet structure for drainage if the basins were to exceed its design capacity. Local terrain serves as the receiving area for these basins. During a rainfall event larger than the design basis, the potential exists to overflow the basins. If at all possible, IIFP will sample and approve discharge from the retention (evaporation) basins. However, overflow of the basins is an unlikely event. The additional impact to the surrounding land over that which will occur during such a precipitation event alone will be small. Therefore, potential overflow of the Stormwater Retention Basin and the Cylinder Pad Stormwater Retention Basin during an event beyond its design basis is expected to have a SMALL impact on water quality or the surrounding land.

The existing groundwater monitoring program at the site will be supplemented with a focus on detecting any unforeseen impacts to groundwater quality associated with the Proposed Action (see Chapter 6 of this Report, "Environmental Measurement and Monitoring Programs"). Although there will be only a small potential for indirect impacts to groundwater quality, stormwater and effluent sampling will be conducted as necessary in accordance with the NPDES permit to protect surface water quality. In addition, site-wide groundwater levels will be monitored routinely, and the groundwater monitoring-well and pumping-well networks will be analyzed to confirm that the changes in groundwater levels associated with the Proposed

Action are minimal. Thus, the impact of the Proposed Action on off-site groundwater quality and the effectiveness of the existing on-site pumping well system are SMALL.

Water discharged from the IIFP site sanitary waste treatment system will meet required levels for all contaminants stipulated in any permit or license required for that activity, including 10 CFR 20 (CFR, 2009a) and a Groundwater Discharge Permit/Plan. The State of New Mexico has adopted the U.S. EPA hazardous water regulations (40 CFR Parts 260 through 266, 268 and 270) (CFR, 2009v; CFR, 2009w; CFR, 2009x; CFR, 2009y; CFR, 2009z; CFR, 2009aa; CFR,2009bb; CFR, 2009cc; CFR, 2009dd) governing the generation, handling, storage, transportation, and disposal of hazardous materials. These regulations are found in 20.4.1 NMAC, Hazardous Waste Management (NMAC, 2009). Therefore, the impact of the site sanitary waste treatment system on water quality is SMALL.

4.4.8 Identification of Predicted Cumulative Effects on Water Resources

The IIFP site and the surrounding land have been and continue to be used for oil/gas production and power generation. Except for pre-licensing and general construction, operation, and eventual decommissioning of the IIFP plant, the water use is expected remain virtually unaffected. There are no anticipated cumulative impacts from these uses. The cumulative water use impacts resulting from the Proposed IIFP Facility are SMALL.

The IIFP facility will not extract any surface water from the site and will obtain its water from the Ogallala Aquifer. Groundwater usage as described in Section 4.4.5, “Ground and Surface Water Use,” will have minimal impacts to the aquifer. IIFP will not discharge any effluent to the site other than into the engineered basins for evapotranspiration and re-use in the plant processes or for landscape watering. As a result, no significant effects on natural water systems are anticipated. Thus no cumulative effects are predicted.

4.4.9 Decommissioning

Decommissioning of the Proposed IIFP Facility will involve the removal of the internal equipment, utilities, and products from the building; however, the physical structure, associated foundations, access roads, and utility lines will likely remain intact. Landscape areas and maintained lawn areas established at the completion of the construction phase could be impacted during the decommissioning process for staging of equipment or temporary storage of materials. Erosion-control BMPs similar to those required during the construction phase will be used to mitigate potential impacts during the decommissioning phase.

The Decommissioning Plan to be prepared at the end of IIFP facility life will include decontamination, dismantlement, and clean-up procedures; methodology and general decontamination and cleaning methods; and waste management protocol. These procedures, methods, and protocol will be designed to prevent impacts to groundwater quality; therefore, impacts to groundwater quality during decommissioning will be SMALL. Sampling will also be integral to the decommissioning process to demonstrate that any residual impacts, as compared to the baseline sampling results, meet NRC and EPA guidelines.

Sanitary and process wastewater effluent discharges will gradually decrease during decommissioning as the processes and number of personnel in the Proposed IIFP Facility decrease. Stormwater will continue to be routed from the Proposed IIFP Facility to the Stormwater Retention Basins during and after the decommissioning phase; therefore, no additional impacts will occur. The overall impact to surface water quality from the decommissioning phase will be SMALL.

4.4.10 Comparative Water Resources Impacts of Alternative Actions

ER Chapter 2 provides a discussion of possible alternatives to the construction and operation of the IIFP facility, including an alternative of "No-Action," i.e., not building the IIFP facility. Additionally, IIFP considered reasonable alternatives using alternative technologies for de-conversion services and production of fluorine products.

4.4.10.1 No-Action Alternative

The DOE de-conversion facilities are sized and built to dispose of the DOE DUF₆ inventory. The de-conversion and disposal is expected to take 20 to 25 years. If DOE were to process privately owned DUF₆, de-conversion would likely have to await completion of the DOE mission or DOE would have to add additional capacity to their plants. A 20 to 25 year delay in processing the DUF₆ would force private enrichment facilities to store tails on site or to build or use their own de-conversion facilities.

The No-Action Alternative of long-term storage of DUF₆ would impact water resources at the enrichment facilities due to the construction of storage facilities and may present potential unnecessary risk to the public. If DOE were to expand its facilities for additional capacity, additional water resources impacts will be incurred at Paducah, KY and/or Piketon, OH. If the commercial enrichment facilities had to store tails indefinitely, no water resource impacts are anticipated. Additionally, if the Proposed Action is not implemented, there will be no water resource impact to New Mexico.

4.4.10.2 Reasonable Alternative Actions

One of the Reasonable Alternatives considered utilization of the alternate DOE de-conversion technology on the Proposed IIFP Site near Hobbs, New Mexico. This alternative technology is the same as that which will be used in the de-conversion process utilized at the DOE sites at Paducah, KY and Piketon, Ohio. With this DOE technology, UF₆ reacts with water and hydrogen to produce uranium oxide, which must be disposed of as waste in a licensed facility, and aqueous HF that has a lower market value than AHF. The water resources impacts of this alternative are essentially the same as the Proposed Action.

Two of the enrichment companies have de-conversion facilities overseas and could choose to ship their DUF₆ from the U.S. to those facilities for de-conversion. Those companies that do have existing overseas facilities and technologies would be required to ship DUF₆ overseas long-distances and may have to return the waste oxides to United States for licensed disposal or may have to arrange with other countries for disposal. It is expected that water resources impacts for this option of shipping the DUF₆ overseas may be similar to the Proposed Action.

The four enrichment companies could decide to build and operate their own de-conversion facilities in the U.S. If those companies were to build new facilities to de-convert "tails" material, it is expected that the water resources impacts for this Reasonable Alternative are expected to be similar to the Proposed Action.

See Section 4.4.10.1 for the environmental impacts on water resources should the enrichment companies utilize existing DOE de-conversion facilities.

4.5 Ecological Resources Impacts

4.5.1 Maps

See Figure 4-5, “Sand Dune Lizard Habitat Areas.”

4.5.2 Proposed Schedule of Activities

The following is a tentative, abbreviated schedule of proposed activities. Refer to ER Section 1.2.3, “Projected Construction and Operational Startup Schedules,” for major steps in the Proposed Action:

- Submit Environmental Report--December 2009
- Submit Integrated Safety Analysis--December 2009
- Submit Facility License Application--December 2009
- Initiate Pre-licensing Construction—Early 2011
- Initiate Phase 1 Facility Construction--Late 2011
- Achieve Phase 1 Start-up Operation--Late 2012
- Complete Phase 2 Construction--March 2016
- Achieve Phase 2 Start-up Operation –June 2016

4.5.3 Area of Disturbance/Site Preparation and Construction

Most of the impacts to ecological resources will occur during the preparation of the IIFP facility site and construction of the Proposed IIFP Facility, of which the major activities are planned to occur over 20-24 months. The area of land to be disturbed is approximately 16.2 ha (40 ac). This area includes about 2 ha (5 ac) that will be used for contractor parking and lay-down areas. The contractor lay-down and parking area will be restored after completion of plant construction. (See ER Figure 4-1, “IIFP Integrated Facility,” for a map indicating proposed buildings and surrounding areas.)

4.5.4 Construction Practices

Standard land clearing methods, primarily the use of heavy equipment, will be used during the pre-licensing and general construction phases of the IIFP site. Both temporary and permanent erosion, runoff and situation control methods will follow the BMPs referenced in ER Section 4.1, “Land Use Impacts.” Additionally, Stormwater Retention Basins will be constructed prior to land clearing and used as sedimentation collection basins during construction then converted to a retention basin once the site is revegetated and stabilized. When required, applications of water will be used to control dust in construction areas. Water conservation will be considered when deciding how often dust suppression sprays will be applied. After construction is complete, the site will be stabilized with native grass species, pavement, and crushed stone to control erosion. Ditches, unless excavated in rock, will be lined with riprap, vegetation, or other suitable material as dictated by water velocity to control erosion. Furthermore, any eroded areas that may develop will be repaired and stabilized. See ER Section 4.1 for additional information on BMPs that IIFP will use for the construction activities.

Mobile animals will be able to avoid direct impacts during preparation of the IIFP facility site and construction of the facility by moving to unaffected areas on the site or to neighboring properties; however, there will be adverse impacts to these populations from increased competition for existing resources between and within wildlife species. Indirect impacts to wildlife during construction may include increased noise (see Section 4.7, “Noise Impacts”), disruption of travel corridors, and behavioral

modifications. Wildlife on the site are adapted to current conditions, which include roads that fragment communities, loud noises from pumping at the oil/gas rigs, and irregular travel of vehicles on existing roads. Overall, wildlife populations on the Proposed Site will be altered but will not be destabilized; therefore, direct and indirect impacts to wildlife will be MODERATE.

4.5.5 Operation

The operation of the Proposed IIFP Facility will not directly impact additional biotic communities beyond those impacted during the site preparation and construction phase. Fencing around the Proposed IIFP Facility could cause additional disruption of wildlife travel corridors. However, wildlife would develop new travel corridors and utilize the fence line and the new road as corridors. Human encounters with some wildlife could increase due to disruption of travel corridors and loss of habitat. Operation of the IIFP facility will not noticeably alter the impact to biotic communities or wildlife. Impacts to travel corridors and habitat quality are SMALL.

Non-radiological air emissions from the IIFP facility will be lower than the National Ambient Air Quality Standards (NAAQS) for humans (see Section 4.6, "Air Quality Impacts"); however, emissions from vehicles and very small emissions from the operation of the facility will occur and could have small impacts to wildlife. No rare or unique habitats will be directly affected by the operational phases of the Proposed Action; therefore, overall indirect impacts from non-radiological air emissions will be SMALL.

4.5.6 Area of Disturbance by Habitat Type

The Proposed IIFP Site consists of one vegetation community type. The Basin and Range vegetation community is identified by the dominant presence of deep sand tolerant and deep sand-adapted plants. The Basin and Range vegetation community is common in parts of southeastern New Mexico. Density of specific plant species varies slightly across the proposed site. Differences in the composition of the vegetation community within the proposed site are accounted for by slight variations in soil texture and structure and small changes in aspect.

The majority of the proposed site is suitable for use by wildlife resources. The Basin and Range provides potential habitat for an assortment of birds, mammals, and reptiles (Reference ER Section 3.5.2, "General Ecological Conditions of the Site").

The total area of disturbance proposed for the IIFP site is approximately 16.2 ha (40 ac) of the 259-ha (640-ac) Section. The disturbance will have a SMALL affect the Basin and Range vegetation community.

4.5.7 Maintenance Practices

Maintenance practices such as the use of chemical herbicides, roadway maintenance, and clearing practices will be employed both during construction and plant operation. However, none of the practices are anticipated to permanently affect biota. (See ER Sections 4.1.1 and 4.2.5 for construction and maintenance BMPs.)

Herbicides may be used in limited amounts according to government regulations and manufacturer's instructions to control unwanted vegetation during operation of the facility. Additionally, natural, low-water consumption landscaping will be used and maintained. Any eroded areas that may develop will be repaired and stabilized.

Roadway maintenance practices will be employed both during construction and operational phases of the IIFP facility. These practices do not represent a significant impact to biota.

Clearing practices will be employed during the pre-licensing construction phase of the IIFP project. The additional noise, dust and other factors associated with the clearing practices will be short-lived in duration and represent only a temporary SMALL impact to the biota of the IIFP site.

Additionally, only 16.2 ha (40 ac) of the 259-ha (640-ac) total Section area will be disturbed, affording the biota of the site an opportunity to move to undisturbed areas within the IIFP site as well as additional areas of suitable habitat bordering the IIFP site. Refer to ER Section 4.1, "Land Use Impacts," for construction and clearing BMPs.

4.5.8 Short-Term Use Areas and Plans for Restoration

The area to be used on a short-term basis during construction, including contractor parking and lay-down areas, will be limited to approximately 2 ha (5 ac). These areas will be revegetated with native plant species and other natural, low-water consumption landscaping to control erosion upon completion of site construction and returned as close as possible to original conditions. Lay-down (short term use areas) will be selected as to minimize the impacts to local vegetation.

4.5.9 Activities Expected to Impact Sensitive Communities or Habitats

No communities or habitats that have been defined as rare or unique or that support threatened and endangered species have been identified on the 259-ha (640-ac) IIFP Section. Thus, no proposed activities are expected to impact communities or habitats defined as rare or unique or that support threatened and endangered species within the 640-acre Section.

The Range and Basin vegetation community at the IIFP site does have the potential to provide habitat for the lesser prairie chicken, the sand dune lizard and the black-tailed prairie dog. The lesser prairie chicken is currently on the federal candidate list for listing as a threatened species. The sand dune lizard is currently listed as a threatened species on the New Mexico State Rare, Threatened and Endangered (RTE) Species List. The black-tailed prairie dog is a federal listed candidate species; however, it has no state listing.

No lesser prairie chickens have been observed at the IIFP site. Located in the Range and Basin vegetation community, the IIFP site does provide potential habitat for the lesser prairie chicken, although the vegetation community is common in the general area. The Proposed IIFP Site is not in the current distribution of the lesser prairie chicken (See Figure 3-37). However, field surveys for the lesser prairie chicken on the IIFP site will be conducted prior to initiation of construction.

No surveys have been conducted for the sand dune lizard; however, various factors make the site unsuitable as its habitat. The closest known sand dune lizard population is approximately 16.1 km (10 mi) south of the IIFP site. See Figure 4-5, "Sand Dune Lizard Habitat Areas."

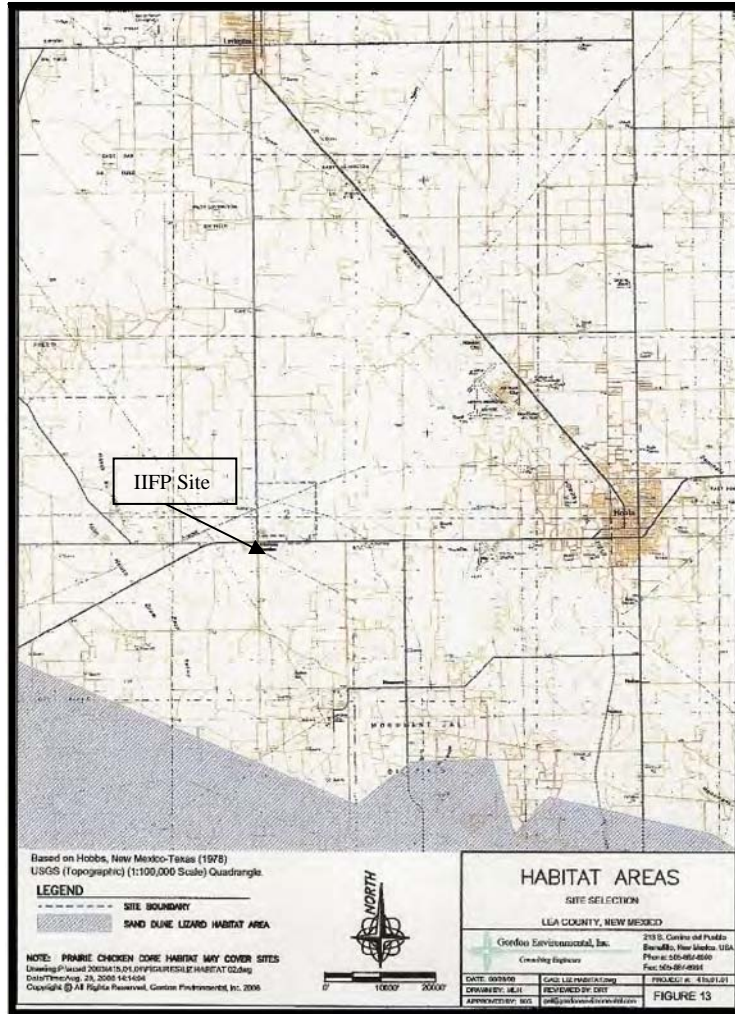

Source: EDCLC, 2008

Figure 4- 5 Sand Dune Lizard Habitat Areas

Although black-tailed prairie dogs have expanded their range into shinnery oak and other grass-shrub habitats, they usually establish colonies in short grass vegetation types. The predominant basin and range vegetation type on the IIFP site is not optimal prairie dog habitat due to high density shrubs.

The swift fox is vulnerable to construction activities that will result in a direct loss of breeding habitat (burrows/dens) and to a decrease in the rodent population that is the primary food source for the swift fox. Because the species has adapted to areas of human activities such as overgrazed pastures, plowed fields, and fence rows, it could potentially be present during the IIFP construction and operations. Decommissioning activities will have similar impacts on the swift fox as the construction phase with the potential for den/burrows being destroyed and the disruption of the rodent/rabbit food source.

The western burrowing owl is generally vulnerable to construction activities because of the possibility that burrows, and possibly birds or eggs in the burrows, may be destroyed by machinery or structures. The species is generally tolerant of human activity, provided they are not harassed. Relocation of active burrowing owl colonies may allow continued existence of the birds in the area if usable burrows and appropriate open habitats are provided.

4.5.10 Impacts of Elevated Construction Equipment or Structures

The construction of new stacks can create a potential impact on migratory birds, especially night-migrating species. Some of the species affected are also protected under the Endangered Species Act and Bald and Golden Eagle Act. However, the estimate of the potential impacts of elevated construction equipment or structures on species is extremely low for the IIFP site. The tallest building is 21.3m (70 ft).

Emission stacks are proposed to be less than 30.5 m (100 ft) tall. Both are well under the 61 m (200 ft) threshold that requires lights for aviation safety. This avoidance of lights, which attract species, and the low above ground level structure height, also reduces the relative potential for impacts. Additionally, security lighting for all ground level facilities and equipment will be directed downward to help to reduce the potential for impacts (USFWS, 1998). The impacts of elevated construction equipment or structures on the ecological species are expected to be SMALL.

4.5.11 Tolerances and Susceptibilities of Important Biota to Pollutants

Three of the species [i.e., game species (the mule deer, the lesser prairie chicken and the scaled quail)], are highly mobile species and are not susceptible to localized physical and chemical pollutants as other less mobile species such as invertebrates and aquatic species. Due to the lack of direct discharge of water, stormwater management practices (i.e., fenced and netted retention basins), and the lack of aquatic systems at the IIFP site, no significant impacts to aquatic systems are expected. Additionally, the two identified species of concern in the general area, the lesser prairie chicken and the sand dune lizard, are not known to occur on the IIFP site.

The mule deer has a relatively high tolerance to physical pollution such as noise, as do other smaller wildlife species such as rodents and coyotes that may inhabit the IIFP site. Larger wildlife species such as mule deer may be affected by chemical pollution by direct ingestion or contamination of plant species that serve as a food source. Depending on the type of chemical pollution, mule deer have tolerance levels that range from low to high (DOE, 2001h; Haney, 1996). Small wildlife species will exhibit a greater susceptibility to chemical pollution by direct ingestion.

4.5.12 Special Maintenance Practices

No important habitats (e.g.; marshes, natural areas, bogs) have been identified within the 259-ha (640-ac) IIFP Section. Therefore, no special maintenance practices are proposed.

4.5.13 Wildlife Management Practices

IIFP is proposing to incorporate several wildlife management practices in association with the IIFP facility. These wildlife management practices are delineated in Section 5.2.5, "Ecological Resources." In addition to these proposed wildlife management practices, IIFP will consider all recommendations of appropriate state and federal agencies including the U.S. Fish and Wildlife Service (USFWS) and the New Mexico Department of Game and Fish.

4.5.14 Practices and Procedures to Minimize Adverse Impacts

Several practices and procedures have been designed to minimize adverse impacts to the ecological resources of the IIFP site. These practices and procedures include the use of BMPs recommended by various state and federal management agencies, minimizing the construction footprint to the extent possible, avoiding all direct discharge (including stormwater) to any waters of the United States (i.e., the

use of retention basins), the protection of all undisturbed naturalized areas, and site stabilization practices to reduce the potential for erosion and sedimentation. Based on recommendations from the New Mexico Department of Game and Fish, retention basins will be fenced to exclude wildlife and the basin surface areas netted, or other suitable means utilized, to minimize the use of retention basin by birds and waterfowl. The use of native plant species in disturbed area for revegetation will enhance and maximize the opportunity for native wildlife habitat to be reestablished at the site.

4.5.15 Decommissioning

Decommissioning activities will occur within the limits of the IIFP facility. Landscape areas and maintained lawn areas established at the completion of the construction phase could be impacted during the decommissioning process. Disturbed areas will be re-planted in accordance with the regulations at the time of decommissioning. Impacts from possible radiological exposure will be similar to or less than exposure during the operation phase. The Decommissioning Plan regulations by the NRC and EPA minimize impacts to humans and, as a result, also afford protection to ecological resources. Overall impacts to wildlife and biotic communities from the decommissioning of the Proposed IIFP Facility will be SMALL.

4.5.16 Cumulative Impacts

During construction the Proposed IIFP Site could have an effect on terrestrial wildlife by causing loss of habitat, food sources, and travel corridors. The effect will be the loss of approximately 40 acres (16.2 ha) of habitat from the Proposed Action. Impacts during construction to ecological resources are MODERATE.

Cumulatively, the Proposed Action will only have SMALL impacts to these rare and unique communities and to migratory bird habitat during operations and decommissioning; therefore, cumulative impacts to ecological resources from the Proposed Action is SMALL.

4.5.17 Comparative Ecological Resource Impacts of Alternative Actions

ER Chapter 2 provides a discussion of possible alternatives to the construction and operation of the IIFP facility, including an alternative of "No-Action," i.e., not building the IIFP facility. Additionally, IIFP considered reasonable alternatives using alternative technologies for de-conversion services and production of fluorine products.

4.5.17.1 No-Action Alternative

The DOE de-conversion facilities are sized and built to dispose of the DOE DUF₆ inventory. The de-conversion and disposal is expected to take 20 to 25 years. If DOE were to process privately owned DUF₆, de-conversion would likely have to await completion of the DOE mission or DOE would have to add additional capacity to their plants. A 20 to 25 year delay in processing the DUF₆ would force private enrichment facilities to store tails on site or to build or use their own de-conversion facilities.

The No-Action Alternative of long-term storage of DUF₆ would impact ecological resources at the enrichment facilities due to the construction of storage facilities and may present potential unnecessary risk to the public. If DOE were to expand its facilities for additional capacity, additional ecological resources impacts will be incurred at Paducah, KY and/or Piketon, OH. If the Proposed Action is not implemented, there will be no ecological resources impact to New Mexico.

4.5.17.2 Reasonable Alternatives

One of the Reasonable Alternatives considered utilization of the alternate DOE de-conversion technology on the Proposed IIFP Site near Hobbs, New Mexico. This alternative technology is the same as that which will be used in the de-conversion process utilized at the DOE sites at Paducah, KY and Piketon, OH. With this DOE technology, UF_6 reacts with water and hydrogen to produce uranium oxide, which must be disposed of as waste in a licensed facility, and aqueous HF that has a lower market value than AHF. The ecological resources impacts of this alternative are essentially the same as the Proposed Action.

Two of the enrichment companies have de-conversion facilities overseas and could choose to ship their DUF_6 from the U.S. to those facilities for de-conversion. Those companies that do have existing overseas facilities and technologies would be required to ship DUF_6 overseas long-distances and may have to return the waste oxides to United States for licensed disposal or may have to arrange with other countries for disposal. It is expected that ecological resources impacts for this option of shipping the DUF_6 overseas may be similar to the Proposed Action.

The four enrichment companies could decide to build and operate their own de-conversion facilities in the U.S. If those companies were to build new facilities to de-convert "tails" material, it is expected that the ecological resources impacts for this Reasonable Alternative are expected to be similar to the Proposed Action.

See Section 4.5.17.1 for the environmental impacts on ecological resources should the enrichment companies utilize existing DOE de-conversion facilities.

4.6 Air Quality Impacts

This section describes the air quality impacts of the Proposed Action. Under the Proposed Action, a fluorine extraction and depleted uranium de-conversion facility will be built at Hobbs, New Mexico. New on-site air emission sources will be created at the proposed site during the pre-licensing and general construction, operation, and decommissioning of the Proposed IIFP Facility. The source types and the constituents and levels of the emissions to the atmosphere from the sources will vary over the life of the project. The use of air emissions control systems and the implementation of other planned mitigation measures for these on-site sources will reduce the levels of air emissions actually released to the atmosphere. Automobile and truck traffic traveling to and from the Proposed IIFP Facility will incrementally add small quantities of air emissions to the total motor vehicle air emissions to Lea County.

4.6.1 Air Quality Impacts from Construction

The primary source of on-site air emissions during the pre-licensing or general construction period will be fugitive dust. Fugitive dust is airborne particulate matter (PM) that is not emitted from a definable point source, such as a combustion unit stack or a process vent, but rather is emitted from natural and man-made area sources open to the atmosphere (e.g., exposed soils, unpaved roadways, material storage piles and handling operations, construction activities). Engine exhaust air emissions will be produced by heavy-duty, off-road construction equipment operated at the IIFP facility site. There will be no radioactive materials stored or used at the IIFP facility site during the initial construction phases. Small quantities of volatile organic compound (VOC) emissions will be released from the refueling and on-site maintenance of the off-road construction equipment used for construction. There is the potential for additional VOC emissions from certain painting and other construction-finishing activities, depending on the amounts of organic solvent-based paints and architectural coatings that will be used for the buildings and other structures. Air emissions from the automobiles and trucks traveling to and from the Proposed

IIFP Facility will be associated with the transportation impacts projected to occur from constructing the IIFP facility.

Construction of large projects the scale of the IIFP facility commonly produce fugitive dust emissions. These PM emissions typically are produced by the operation of heavy-duty, off-road construction equipment at the construction site for land-clearing, ground excavation, grading, and foundation work. The level of fugitive dust emissions at a typical construction site will vary from day to day, depending on the specific construction activities conducted, soil types exposed to the air, and meteorological conditions (e.g., amount of recent precipitation, wind speed). Wind blowing over disturbed areas of a construction site and on-site building material storage piles is also a potential source of fugitive dust emissions. Best management practices during the construction of the facility are described in Section 4.1.3, “Control of Impacts.” With the implementation of these BMPs, the air quality impacts on construction are anticipated to be SMALL

In addition to fugitive-dust emissions generated by the movements of heavy, off-road construction equipment at the IIFP facility site, additional air emissions will be released from the exhaust of the diesel engines used to power this equipment. Different mixes of heavy-duty, off-road construction equipment will be used for IIFP facility site preparation and access road construction (e.g., dozers, graders, loaders) than will be used during the later construction stages involving erection of the buildings, installation of utilities, and other general construction activities (e.g., cranes, forklifts, aerial lifts). Exhaust air emissions from diesel-engine-powered, off-road equipment consist of carbon monoxide (CO), nitrogen oxides (NO_x), sulfur dioxide (SO₂), PM, and VOCs. The emissions from each type of off-road equipment are a function of equipment-specific factors, including engine horsepower, load factor, and hours of operation.

An estimate of the air emissions resulting from operation of the off-road construction equipment at the IIFP facility site was made using the site-specific assumptions. The estimated air emissions for the off-road construction equipment used at the IIFP facility site are presented in Table 4-11.

Emission rates from vehicle exhaust and fugitive dust, as listed in Table 4-11, “Emission Rates during Construction,” were estimated for a 10-hour workday assuming peak construction activity levels were maintained throughout the year. Fugitive dust will originate predominantly from vehicle traffic on unpaved surfaces, earth moving, excavating and bulldozing, and to a lesser extent from wind erosion. It was assumed that the total disturbed area of the site was 16.2 ha (40 ac).

Table 4- 11 Emission Rates during Construction¹

Pollutant	Average Emissions	
	g/hr	lb/hr
Vehicle Emissions		
Hydrocarbons as Aldehydes	272	0.6
Carbon Monoxide	3,400	7.5
Nitrogen Oxides	11,880	26.2
Sulfur Oxides	770	1.7
Particulates	816	1.8
Fugitive Emissions		
Particulates as TOC ²	8,850	10.7

¹Based on 10 hours per day, 5 days per week, and 50 weeks per year

²TOCs as evaporative exhaust crankcase refueling.

Source: APTS, 2009.

Of the combustion sources, vehicle exhaust will be the dominant source. Fugitive volatile emissions will also occur because vehicles will be refueled on site. Estimated vehicles that will be operating on the site during construction consist of two types: support vehicles and construction equipment. The support vehicles included thirteen miscellaneous gasoline trucks and four smaller utility vehicles. Emission factors in AP-42 for highway mobile sources were used to estimate emissions of criteria pollutants and non-methane hydrocarbons for these vehicles. Thirteen pieces of miscellaneous construction equipment were used to estimate the emissions. Emission factors provided in AP-42, the U.S. Environmental Protection Agency's Compilation of Air Pollutant Emission Factors (EPA, 2009a) for diesel-powered construction equipment were used for these vehicles. Pre-licensing construction activities will reduce the work density and lower the concentration of air emissions at any given time. The gross amount of emissions will be unaffected.

Air quality impacts from site preparation for the IIFP plant were evaluated using emission factors and air dispersion modeling. Emission rates of Clean Air Act Criteria Pollutants and non-methane hydrocarbons (a precursor of ozone, a Criteria Pollutant) are estimated for exhaust emissions from construction vehicles and for fugitive dust using emission factors provided in AP-42, the U.S. Environmental Protection Agency's Compilation of Air Pollutant Emission Factors (EPA, 2009a). The total emission rates are used to scale the output from the Industrial Source Complex Short-Term (ISCST3) air dispersion model (air concentrations derived using a unit source term) to estimate both short-term and annual average air concentrations at the facility property boundary. ISCST3 is a refined, U.S. EPA-approved air dispersion model in the Users Network for Applied Modeling of Air Pollution (UNAMAP) series of air models (EPA, 1987). It is a steady-state Gaussian plume model that can be used to estimate ground-level air concentrations from industrial sources out to a distance of 50 km (31 mi). The air dispersion modeling is discussed in more detail in Section 4.6.2.3 of this ER.

Emissions were estimated in ISCST3 as a uniform area source with emissions occurring 10 hours per day, 5 days per week, and 50 weeks per year. The maximum predicted air concentrations at the site fence boundary for the various averaging periods predicted using five years (1987 to 1991) of hourly meteorological data from the Midland-Odessa, Texas, National Weather Service (NWS) station are presented in Table 4-12. These concentrations are compared to the appropriate National Ambient Air Quality Standard (NAAQS).

No NAAQS has been set for hydrocarbons; however, the total annual emissions of hydrocarbons predicted from the site [approximately 12,130 kg (26,750 lb or 13.4 tons)] are well below the level of 36,287 kg (40 tons) that defines a significant source of volatile organic compounds (40 CFR 50.21) (CFR, 2009h). Air concentrations of the Criteria Pollutants predicted for vehicle emissions were all at least an order of magnitude below the NAAQS. PM₁₀ emissions from fugitive dust were also below the NAAQS. The results of the fugitive dust estimates should be viewed in light of the fact that the peak anticipated fugitive emissions were assumed to occur throughout the year. These conservative assumptions will result in predicted air concentrations that tend to overestimate the potential impacts. ER Section 1.4.4, "State Agencies," presents information regarding the status of all State of New Mexico permits.

The results of air modeling show that annual average and short-term ambient air concentrations from fugitive dust and on-site motor vehicle emissions produced by construction activities for the Proposed IIFP Facility will be orders of magnitude below the level of the applicable ambient air quality standards. These incremental air quality impacts from the air emissions from preparation of the IIFP facility site and construction of the facility will not measurably change the existing ambient air quality in the vicinity of the Proposed IIFP Facility; therefore, the air quality impacts resulting from the construction of the Proposed IIFP Facility are anticipated to be SMALL.

Table 4- 12 Predicted Property-Boundary Air Concentrations and Applicable National Ambient Air Quality Standards

Emission Types		Max 1-hr	Max 3-hr	Max 8-hr	Max 24-hr	Annual
Vehicle Emissions ($\mu\text{g}/\text{m}^3$)						
HC	Modeled NAAQS	357 ---	134 ---	47 ---	21 ---	2 ---
CO	Modeled NAAQS	4,441 40,000	1,670 ---	591 10,000	258 ---	20 ---
NO _x	Modeled NAAQS	15,496 ---	5,828 ---	1,926 ---	900 ---	71 44
SO _x	Modeled NAAQS	998 ---	375 1,310 (secondary)	133 ---	58 365	5 80
PM ₁₀	Modeled NAAQS	1,071 ---	403 ---	142 ---	62 150	5 50
Fugitive Dust ($\mu\text{g}/\text{m}^3$)						
PM ₁₀	Modeled NAAQS	11,548 ---	4,343 ---	1,536 ---	671 150	53 50

HC – hydrocarbons; CO – carbon monoxide; NO_x – nitrogen dioxide; SO_x – sulfur oxides; PM₁₀ – particulate matter less than 10 microns; NAAQS – National Ambient Air Quality Standards; $\mu\text{g}/\text{m}^3$ – microgram per cubic meter; hr – hour--no standard

4.6.2 Air Quality Impacts from Operations

On-site air quality will be impacted during operation due to the operation of boilers and an emergency diesel generator. Operation emission types, source locations, and emission quantities are presented in Table 4-12, “Predicted Property-Boundary Air Concentrations and Applicable National Ambient Air Quality Standards.” Table 4-13 and Table 4-14 show that the total emissions from both these sources are far less than 100 tons per year. Thus, a Clean Air Act Title V permit will not be required.

Table 4- 13 Air Emissions during Operation of On-Site Boilers

Pollutant	Emission Factor	Emissions (ton/year)
Particulate Matter Less Than 10 Microns (PM ₁₀)	7.6E-06	0.50
Sulfur Oxides (SO _x)	6E-07	0.04
Nitrogen Dioxide (NO _x)	1E-05	6.57
Volatile Organic Carbon (VOC)	5.5E-06	0.36
Carbon Monoxide (CO)	8.4E-05	5.5

PM₁₀ – particulate matter less than 10 microns; SO_x – sulfur oxides; NO_x – nitrogen dioxide; VOC – Volatile Organic Carbon; CO – carbon monoxide

Table 4- 14 Estimated Air Emissions during Operation of On-Site Generators

Pollutant	Emission Factor (lb/gal)	Emissions (lb/year)
Particulate Matter Less Than 10 Microns (PM ₁₀)	0.0033	1.05
Sulfur Oxides (SO _x)	0.00785	2.5
Nitrogen Dioxide (NO _x)	0.24	7.7
Volatile Organic Carbon (VOC)	0.00034	0.1
Carbon Monoxide (CO)	0.005	1.6

PM₁₀ – particulate matter less than 10 microns; SO_x – sulfur oxides; NO_x – nitrogen dioxide; VOC – Volatile Organic Carbon; CO – carbon monoxide

NUREG-1748 (NRC, 2003a) requires that atmospheric dispersion factors (X/Q's) be used to assess the environmental effects of normal plant operations and facility accidents. In the following subsections, information is presented about the gaseous effluents, the gaseous effluent control systems, and computer models and data used to calculate atmospheric dispersion and deposition factors.

4.6.2.1 Description of Gaseous Effluents

Nonradioactive gaseous effluents include hydrogen fluoride (HF), silicon tetrafluoride (SiF₄), and boron trifluoride (BF₃). HF releases are estimated to be about 8.9 kg (19.6 lb) each year with SiF₄ and BF₃ releases estimated at 82 g (0.18 lb) and 399 g (0.88 lb) each year. Two natural gas-fired boilers will be used to provide steam for the plant heating and autoclave feed system. Emission data estimated for the boiler indicate that it will not emit more than 13.2 metric tons (14.5 tons) per year of any regulated air pollutant. At 100% power, the boiler will emit 5.6 metric tons (6.2 tons) per year of carbon monoxide (CO), 6.9 metric tons (7.6 tons) per year of nitrogen oxides (NO), and 366 kg (0.4 tons) per year of volatile organic compounds (VOC). The boilers will not require an air quality permit from the State of New Mexico (NMEDAQB, 2009).

In comparison, Table 4-15 shows the emissions for the subject emission types for Lea County in New Mexico and for Andrews and Gaines Counties in Texas as well as the largest counties in each state. Emissions for these listed types are also presented for Bernalillo County where Albuquerque, New Mexico is located and for Dallas and Harris Counties in Texas where Dallas and Houston, respectively, are located. Lea County has greater NO_x, SO₂, and NH₃ emissions than the more populated and industrialized Bernalillo County; however, the total emissions for Lea County are approximately 32% of those for Bernalillo County. Gaines County has greater CO, PM_{2.5}, PM₁₀ and NH₃ emissions than Andrews County with VOC concentrations approximately the same with the total emissions approximately 119% greater. Harris County emissions for each type greatly exceed those emissions from Dallas County with total emissions 167% higher. Except for NH₃, the emissions from Gaines County are

Table 4- 15 Annual Emissions at Lea County, New Mexico, and Andrews and Gaines Counties, Texas In Comparison with Larger New Mexico/Texas Counties

County, State	Emissions (Tons)							
	CO	NO _x	VOC	SO ₂	PM _{2.5}	PM ₁₀	NH ₃	Total
Lea County, New Mexico	31,185	38,160	6,713	16,096	5,188	28,548	2,101	95,996
Bernalillo Co., New Mexico	185,250	24,930	24,310	1,568	8,183	61,892	908	298,857
Andrews Co., Texas	6,680	3,259	2,873	1,398	440	1,577	612	28,363
Gaines Co., Texas	7,709	2,791	2,696	735	1,825	8,650	4,971	33,762
Dallas Co., Texas	550,278	77,452	75,013	21,488	11,332	60,869	3,238	788,339
Harris Co., Texas	763,618	200,053	146,366	57,624	28,858	149,569	7,457	1,316,887

A ton is equal to 0.9078 metric ton
VOC: volatile organic compounds
NO_x: nitrogen oxides
CO: carbon monoxide
Source: Based on 2002 data (EPA, 2009b)

SO₂: sulfur dioxide
PM_{2.5}: particulate matter less than 2.5 microns
PM₁₀: particulate matter less than 10 microns

generally less than 5% of the emissions from Harris County. The CO, NO_x, VOC, and SO₂ emissions from Gaines County are well less than 1% of those of Harris County.

In addition, there will be a diesel generator on site for use as emergency power sources. However, the use of the diesel generator will be administratively controlled (i.e., only run a limited number of hours per year) and are exempt from air permitting requirements of the State of New Mexico. Other smaller standby diesel generators may also be used to provide backup power to some specific systems. The number and size of these other diesel generators are not defined at this time.

The incremental air quality impacts from the air emissions from the Proposed IIFP Facility will not significantly change the existing ambient air quality in the vicinity of the Proposed IIFP Facility; therefore, the air quality impacts that will result from the Proposed IIFP Facility operations are SMALL.

4.6.2.2 Process Off-gas Emission Treatment (Plant KOH Scrubbing System)

Final off-gas streams from the DU₆ to DU₄, SiF₄ and BF₃ processes (comprised mostly of nitrogen, air some relatively low amounts of the product gases and other trace fluorides) enter the Plant KOH Scrubbing System. The off-gases flow through this 3-stage scrubber system for treatment prior to be vented to the atmosphere.

There are two parallel line systems that are basically alike to provide redundancy and operating flexibility. Each scrubber line consists of a primary wet venturi scrubber, followed by a secondary countercurrent-flow gas-liquid packed tower. The third-stage tertiary scrubber is designed to treat gas flow exiting the secondary packed tower scrubber through a bed of sized coke which is wetted by an aqueous KOH solution that serves as the scrubber liquor. The plant KOH scrubbing system uses an aqueous KOH solution that is recycled within each of the scrubbers until the concentration of KOH (spent) needs replenishment. The KOH solution concentration in the scrubber equipment is maintained at a safe margin to ensure it effectively reacts (scrubs) with fluoride components in the gas stream.

When there is a need to replenish the KOH scrubbing liquor concentration, some of the spent scrubbing solution, containing potassium fluoride (KF), water and some excess KOH is pumped from the scrubber recycle tanks to the Environmental Protection Process (EPP). The EPP is described in Section 3.1.7

The system equipment basically consists of a KOH storage tank, pump tank, regenerated KOH tank, two or three (installed spare) venturi scrubbers, two packed towers, and two coke boxes as shown in Figure 3-4. There are redundant pumps for each scrubber, pump tank, and storage tank.

Hydrogen fluoride, from the discharge of the DUF₆ to DUF₄ process and from the SiF₄ and BF₃ pre-condensers is routed to one venturi. Final off-gas streams exiting the SiF₄ and BF₃ processes, containing some of the uncollected SiF₄ and BF₃ and trace quantities of other fluorides are routed to another venturi scrubber.

The plant KOH scrubbing system vents treated gases through a single stack. The three-stage KOH scrubbing system is designed for removing fluoride bearing components in the gas streams at approximate efficiencies of greater than 80%, 95%, and 99% for the first, second, and third stages, respectively. The overall system removal efficiency is designed at greater than about 99.9%. The plant KOH scrubbing system stack is monitored to measure for traces of fluorides or uranium in the vent gas. See Figure 2-8 "Plant KOH Processing Scrubber System Flow Diagram."

4.6.2.3 Calculation of Atmospheric Dispersion and Deposition Factors

NUREG-1748 (NRC, 2003a) requires that atmospheric dispersion factors (X/Q's) be used to assess the environmental effects of normal plant operations and facility accidents. In the absence of on-site meteorological data, the analysis may be conducted using data from 5-year National Weather Service (NWS) summaries, provided applicability of these data to the proposed site is established. The X/Q's have been calculated using meteorological data from Midland-Odessa, Texas (1987 to 1991) and the Gaussian plume model equation documented in NUREG/CR-6410 (NRC 1988) and recommended in NRC Regulatory Guide 1.111 (NRC, 1977). The dispersion parameter is defined as:

$$\chi/Q = 1 / (2\pi U \sigma_y \sigma_z) * \exp(-0.5y^2/\sigma_y^2) * \{ \exp[-0.5(z-h)^2/\sigma_z^2] + \exp[-0.5(z+h)^2/\sigma_z^2] \}$$

where:

$$\chi/Q = \text{dispersion parameter, sec/ m}^3$$

$$U = \text{wind speed, m/sec}$$

$$\sigma_y \text{ and } \sigma_z = \text{dispersion coefficients in the y, and z directions, m}$$

$$y = \text{lateral distance of the receptor from the plume centerline at the downwind location, m (assumed to be zero if the receptor is at the centerline)}$$

$$z = \text{elevation of the receptor above the release point elevation at the downwind location (assumed to be 1.7 m)}$$

$$h = \text{release height above the ground, m (assumed to be zero for ground-level releases)}$$

Dispersion coefficients for Stability Classes A through F are computed from the equations shown in Table 4-16 below, where x = downwind distance, m.

Table 4- 16 Dispersion Coefficients for Gaussian Plume Models

Stability Class	$\sigma_y, \text{ m}$	$\sigma_z, \text{ m}$
A	$0.22x*(1+0.0001x)^{-1/2}$	$0.20x$
B	$0.16x*(1+0.0001x)^{-1/2}$	$0.12x$
C	$0.11x*(1+0.0001x)^{-1/2}$	$0.08x*(1+0.0002x)^{-1/2}$
D	$0.08x*(1+0.0001x)^{-1/2}$	$0.06x*(1+0.0015x)^{-1/2}$
E	$0.06x*(1+0.0001x)^{-1/2}$	$0.03x*(1+0.0003x)^{-1/2}$
F	$0.04x*(1+0.0001x)^{-1/2}$	$0.016x*(1+0.0003x)^{-1/2}$

Use of the Midland-Odessa data for predicting the dispersion of gaseous effluents was deemed appropriate. Midland-Odessa, Texas is the closest first-order NWS station to the IIFP site and both Midland-Odessa and the IIFP site have similar climates. A first-order weather data source is one that is a major weather station staffed by NWS personnel.

Distances to the 16.2-ha (40-ac) Site boundary were determined using guidance from NRC Regulatory Guide 1.145 (NRC, 1983). Annual average atmospheric dispersion is presented in Table 4-17 out to 80 km (50 mi).

Table 4- 17 Annual Average Atmospheric Dispersion Coefficients

Sector	1.6 km (1 mi)	3.2 km (2 mi)	4.8 km (3 mi)	6.4 km (4 mi)	8.0 km (5 mi)	16 km (10 mi)	32 km (20 mi)	48 km (30 mi)	64 km (40 mi)	80 km (50 mi)
N	1.71E-05	8.51E-06	5.41E-06	3.96E-06	3.13E-06	1.62E-06	9.25E-07	6.93E-07	5.72E-07	4.97E-07
NNE	1.32E-05	6.19E-06	3.87E-06	2.80E-06	2.20E-06	1.11E-06	6.18E-07	4.57E-07	3.75E-07	3.23E-07
NE	1.33E-05	6.27E-06	3.92E-06	2.84E-06	2.23E-06	1.13E-06	6.29E-07	4.66E-07	3.82E-07	3.30E-07
ENE	1.64E-05	7.95E-06	5.02E-06	3.66E-06	2.89E-06	1.49E-06	8.46E-07	6.33E-07	5.23E-07	4.53E-07
E	1.98E-05	9.98E-06	6.38E-06	4.68E-06	3.71E-06	1.93E-06	1.11E-06	8.39E-07	6.95E-07	6.05E-07
ESE	2.31E-05	1.21E-05	7.81E-06	5.76E-06	4.59E-06	2.41E-06	1.40E-06	1.06E-06	8.82E-07	7.68E-07
SE	2.23E-05	1.19E-05	7.72E-06	5.71E-06	4.55E-06	2.41E-06	1.40E-06	1.06E-06	8.84E-07	7.71E-07
SSE	1.76E-05	9.04E-06	5.81E-06	4.27E-06	3.39E-06	1.77E-06	1.03E-06	7.73E-07	6.41E-07	5.57E-07
S	1.84E-05	9.56E-06	6.16E-06	4.53E-06	3.60E-06	1.89E-06	1.09E-06	8.26E-07	6.86E-07	5.97E-07
SSW	2.03E-05	1.06E-05	6.87E-06	5.06E-06	4.03E-06	2.12E-06	1.23E-06	9.34E-07	7.76E-07	6.76E-07
SW	1.82E-05	9.29E-06	5.96E-06	4.38E-06	3.48E-06	1.82E-06	1.05E-06	7.95E-07	6.59E-07	5.74E-07
WSW	1.45E-05	7.06E-06	4.47E-06	3.26E-06	2.58E-06	1.33E-06	7.61E-07	5.71E-07	4.72E-07	4.10E-07
W	1.77E-05	8.94E-06	5.72E-06	4.19E-06	3.33E-06	1.74E-06	1.00E-06	7.55E-07	6.25E-07	5.44E-07
WNW	2.02E-05	1.05E-05	6.79E-06	5.00E-06	3.98E-06	2.09E-06	1.21E-06	9.18E-07	7.62E-07	6.64E-07
NW	2.52E-05	1.35E-05	8.81E-06	6.52E-06	5.20E-06	2.76E-06	1.61E-06	1.22E-06	1.02E-06	8.86E-07
NNW	2.01E-05	1.04E-05	6.68E-06	4.91E-06	3.90E-06	2.04E-06	1.18E-06	8.93E-07	7.41E-07	6.45E-07

4.6.3 Decommissioning

Activities required for the decontamination and removal of process equipment from inside of buildings are not expected to produce any significant levels of fugitive dust or other air emissions. Should decommissioning activities include the demolition of buildings and hard surface areas, then heavy-duty, off-road construction equipment will be required for the demolition of the structures and loading of demolition debris into trucks for off-site disposal. These demolition activities will produce fugitive dust emissions that could be mitigated using water sprays and other dust-suppression work practices. Shipping destinations for disposal of the demolition debris removed from the IIFP facility site will depend on the locations of the land disposal, recycling, or other facilities open and accepting material at the time of facility closure.

The number of on-site workers required during the decommissioning of the Proposed IIFP Facility is projected to decrease to approximately 40 workers. Truck traffic for the decommissioning phase will depend on the amounts of equipment, materials, and demolition debris to be removed and the individual destinations to which these materials are shipped. Automobile and truck air emissions for the Proposed IIFP Facility decommissioning phase are expected to be lower than those estimated for the construction and operation phases because of lower-emitting motor vehicles being used at that time as a result of more stringent federal emission standards in effect and new mobile vehicle technologies. Thus, the air quality impacts that will result from the Proposed IIFP Facility decommissioning will be SMALL.

4.6.4 Visibility Impacts

Visibility impacts refer to the degradation in outdoor visibility on a regional basis (commonly referred to as haze). The emissions from man-made sources of fine PM and other pollutants that contribute to fine particle formation in the atmosphere (i.e., secondary organic aerosols) contribute to reduced visibility (i.e., increased haze). Visibility impacts are of special concern in scenic areas of the United States, such as national parks.

Air emissions of the pollutants that contribute to haze formation are predicted to be low from the on-site air emission sources associated with the Proposed IIFP Facility pre-licensing and general construction, operation, and decommissioning phases. Consequently, the air emissions from the Proposed IIFP Facility are expected to have no significant impact on regional visibility; therefore, the visibility impacts resulting from the pre-licensing and general construction, operation, and decommissioning of the Proposed IIFP Facility are SMALL.

4.6.5 Control of Impacts

Air quality impacts resulting from the Proposed IIFP Facility will be controlled by implementing a comprehensive program that incorporates the following air emissions-control components:

- Process design features to inherently lower the potential for air emissions
- Air emissions control systems to capture and remove air pollutants
- Monitoring and inspection programs to detect any air emissions from equipment malfunction so that corrective action can be taken promptly
- Work practices to prevent or reduce air emissions releases.

The air emissions-control measures that will be applied to the Proposed Action are further discussed in Chapter 5, "Mitigation Measures," Section 5.6, "Air Quality".

4.6.6 Cumulative Impacts

The pre-licensing and general construction, operation, and decommissioning of the Proposed IIFP Facility will result in emissions. The sources, pollutant constituents, and quantities of these air emissions will vary over the life of the project. Any air quality impacts resulting from the air emissions will not be cumulative over the pre-licensing and general construction, operation, and decommissioning phases of the Proposed Action.

Criteria pollutant emissions from the Proposed IIFP Facility will be released from a limited number of non-major sources that operate or are conducted intermittently. Consequently, the total annual emissions from these sources will not add significantly to the current emission inventory for Lea County; the impact from air emissions is SMALL. There are no other facilities at or in the vicinity of the site that manufacture products using radioactive materials. Public health impacts associated with these air quality impacts are discussed in Section 4.12, "Public and Occupational Health Impacts." Ecological resource impacts associated with the air quality impacts are discussed in Section 4.5, "Ecological Resources Impacts."

4.6.7 Comparative Air Quality Impacts of No-Action Alternative Scenarios

ER Chapter 2 provides a discussion of possible alternatives to the construction and operation of the IIFP facility, including an alternative of "No-Action," i.e., not building the IIFP facility. Additionally, IIFP considered reasonable alternatives using alternative technologies for de-conversion services and production of fluorine products.

4.6.7.1 No-Action Alternative

The DOE de-conversion facilities are sized and built to dispose of the DOE DUF₆ inventory. The de-conversion and disposal is expected to take 20 to 25 years. If DOE were to process privately owned DUF₆, de-conversion would likely have to await completion of the DOE mission or DOE would have to add additional capacity to their plants. A 20 to 25 year delay in processing the DUF₆ would force private enrichment facilities to store tails on site or to build or use their own de-conversion facilities.

The No-Action Alternative of long-term storage of DUF₆ may present potential unnecessary risk to the public. If DOE were to expand its facilities for additional capacity, additional air quality impacts will be incurred at Paducah, KY and/or Piketon, OH. If a commercial enrichment company or another private company were to build a de-conversion facility, similar air quality impacts as the Proposed Action will occur at another site. If the Proposed Action is not implemented, there will be no air quality impact to New Mexico.

4.6.7.2 Reasonable Alternatives

One of the Reasonable Alternatives considered utilization of the alternate DOE de-conversion technology on the Proposed IIFP Site near Hobbs, New Mexico. This alternative technology is the same as that which will be used in the de-conversion process utilized at the DOE sites at Paducah, KY and Piketon, OH. With this DOE technology, UF₆ reacts with water and hydrogen to produce uranium oxide, which must be disposed of as waste in a licensed facility, and aqueous HF that has a lower market value than AHF. The air quality impacts of this alternative are essentially the same as the Proposed Action.

Two of the enrichment companies have de-conversion facilities overseas and could choose to ship their DUF₆ from the U.S. to those facilities for de-conversion. Those companies that do have existing overseas

facilities and technologies would be required to ship DUF₆ overseas long-distances and may have to return the waste oxides to United States for licensed disposal or may have to arrange with other countries for disposal. It is expected that air quality impacts for this option of shipping the DUF₆ overseas may be similar to the Proposed Action.

The four enrichment companies could decide to build and operate their own de-conversion facilities in the U.S. If those companies were to build new facilities to de-convert “tails” material, it is expected that the air quality impacts for this Reasonable Alternative are expected to be similar to the Proposed Action.

See Section 4.6.7.1 for the environmental impacts on air quality should the enrichment companies utilize existing DOE de-conversion facilities.

4.7 Noise Impacts

Noise is defined as unwanted sound. High levels of noise can damage hearing, cause sleep deprivation, interfere with communication, and disrupt concentration. Even at low levels, noise can be a source of irritation, annoyance, and disturbance to people and communities when it significantly exceeds normal background sound levels. In the context of protecting the public health and welfare, noise implies adverse effects on people and the environment.

4.7.1 Predicted Noise Levels

4.7.1.1 Construction Impacts

The erection of buildings and the paving of parking lots for industrial and commercial development on the land parcels at the IIFP facility will require the use of heavy equipment for the clearing, leveling, and construction of the buildings. Construction will require equipment for excavation, such as backhoes, front loaders, bulldozers, and dump trucks; materials-handling equipment, such as cement mixers and cranes; and compressors, generators, and pumps. Noise generated from this type of equipment will range from 80 to 95 dBA at approximately 15 m (50 ft) (Thalheimer, 2000); which will be equivalent of 50 to 66 dBA at approximately 360 m (1,181 ft). The center of the 40-acre Site is approximately 2,000 feet from the nearest boundary line of the 640-acre Section. Most of the construction activities will occur during weekday, daylight hours; however, construction could occur during nights and weekends, if necessary. Large trucks will produce noise levels around 85 dBA at approximately 15 m (50 ft), which is equivalent of 56 dBA at approximately 360 m (1,181 ft). See Table 4-18.

The IIFP facility will be built on 16.2-ha (40-ac) approximately in the center of the 259-ha (640-ac) Section bounded on the south by U.S. 62/180 and on the west by NM 483. Plant construction will be at least 914 m (3,000 ft) from the site boundary (west). Considering that the sound pressure level from an outdoor noise source decreases 6 decibel units (dB) per doubling of distance, the highest noise level predicted at NM 483 during construction is expected to be within the range of 44 dBA to 59 dBA. The highest noise level is predicted to be less than 44 dBA to 59 dBA along the southern property boundary. At the closest boundary on the east 1,050 ft from the site 16.2-ha (40-ac) fence, the highest noise level is predicted to be 50 to 65 dBA, as well as on the northern boundary (approximately 1,360 ft) The northern and eastern boundaries are open rangeland with interspersed oil and gas facilities/equipment. Pre-licensing construction is expected to generate the same noise levels as above.

Table 4- 18 Attenuated Noise Levels (Decibels A-Weighted^a) Expected for Operation of Construction Equipment

Source	Distance from Source					
	15 m (50 ft)	30 m (98 ft)	45 m (148 ft)	60 m (197 ft)	120 m (394 ft)	360 m (1,181 ft)
Heavy Truck	85	79	76	73	68	56
Dump Truck	84	78	75	72	67	55
Concrete Mixer	85	79	76	73	68	56
Jackhammer	85	79	76	73	68	56
Scraper	85	79	76	73	68	56
Dozer	85	79	76	73	68	56
Generator (< 25 KVA)	82	76	73	70	64	52
Crane	85	79	76	73	68	56
Loader	80	74	71	68	62	50
Paver	85	79	76	73	68	56
Excavator	85	79	76	73	68	56
Claw Shovel	93	87	73	81	75	66
Pile Driver	95	89	86	83	77	65

^a The most common single-number measure is the A-weighted sound level, often denoted dBA. The A-weighted response simulates the sensitivity of the human ear at moderate sound levels (Bruce et al., 2003)
 KVA – kilovolt amps; ft – feet; m – meters.
 Source: Thalheimer, 2000.

The finishing work within the building structures will create noise levels slightly above normal background. Sound levels will be expected to dissipate to near background levels by the time they reach the property boundaries. No sensitive noise resources are located in the immediate vicinity of the site. As shown in Table 3-30, “Site Acceptability Noise Standards as Established by U.S. Department of Housing and Urban Development (HUD),” these predicted noise level ranges fall within acceptable sound pressure levels. ER Section 4.2.3, “Traffic Pattern,” states that U.S. 62/180 is a main trucking thoroughfare for local industry and that there are no sensitive receptors at the IIFP south boundary. In addition, noise levels in the predicted ranges at the south and west boundary lines will only be for a short duration and only during construction of the facilities. Excel Energy’s Cunningham Station is located on NM 483 on the western boundary of the IIFP site, while another utility and gas processing facility are located east and southeast of the site respectively. The south fence line is near to U.S. 62/180 and the west boundary line adjacent to NM 483. The north and east boundary lines are adjacent to vacant land.

Since there is already substantial truck traffic using U.S. 62/180 and NM 483, the temporarily increased noise levels due to construction activities are not expected to adversely affect nearby employees of the Excel Cunningham Station. ER Section 4.2, “Transportation Impacts,” includes further discussion of vehicle traffic.

Due to the temporary and episodic nature of construction and because of the significant distance to the nearest residence approximately 8.5 km (5.3 mi) to the northeast of the site, and since construction activities largely will be during weekday daylight hours, actual construction noise at the site is not expected to have a significant effect on the closest resident. Vehicle traffic will be the most noticeable cause of construction noise. There are no sensitive receptors (hospitals, schools, residences) located close to the intersection of U.S. 62/180 and NM 483 at Arkansas conjunction who will have been the most aware of the increase in traffic due to proximity to the source.

There will be a lower average sound level during building erection, than during site preparation and road construction. The building activities are likely to generate short duration noises, resulting from hauling equipment and handling or moving construction materials, which are typical of building construction. Smaller construction vehicles will be used around the building construction site. Traffic accessing the construction site will increase, but the traffic will consist of smaller passenger or sport utility vehicle/pick-up truck-type vehicles, which are estimated to have a SMALL noise impact to the area.

4.7.1.2 Operational Impacts

Because actual noise estimates are not available for the operation of the IIFP facility, measured noise levels around an automobile assembly plant were used to estimate potential noise impacts conservatively high. These noise levels are 55 to 60 dBA at about 60 m (200 ft) from the plant property. These noise levels will be inaudible at the nearest highway (U.S. 62/180), even with low background noise levels (Cantor 1996). EPA has identified 55 dBA as a nearly average outdoor noise level that, if not exceeded, will prevent activity interference and annoyance (EPA, 1973).

Sound levels from IIFP facility operations will be expected to dissipate to background levels by the time they reach the 640-acre Section property boundary. Certain phases of operation, weather, time of day, wind direction, traffic patterns, season, and the location of the receptor will all impact perceived operational noise levels. Although the noise from the plant and the additional traffic will generally be noticeable on the surrounding U.S. 62/180 and NM 483, the operational noise from the plant is not expected to have a significant noise impact on nearby traffic or the surrounding industries.

Since the nearest residence is located northeast of the IIFP site at a distance of approximately 8.5 km (5.3 mi), the resultant sound level exposure will be below the perception of the human ear. This is because a noise source over such a great distance will be dispersed in air and absorbed by natural landscape, vegetation, and buildings to the point of being masked by background ambient noise at the receptor. Noise impacts from the operation of the IIFP facility are anticipated to be SMALL.

4.7.1.3 Facility Decommissioning

Decommissioning of the Proposed IIFP Facility will produce sound levels similar to or lower than those generated from the IIFP facility site preparation and construction activities. The majority of activities will involve decontaminating and deconstructing facility equipment and hauling the materials off site. As a result, the majority of the noise impacting the community will relate to the noise of hauling traffic. The anticipated noise emissions will be similar to those during the facility construction phases and are therefore estimated to represent a SMALL noise impact.

4.7.2 Noise Sources

Noise point sources for the plant during operation will include: reaction vessels, coolers, rooftop fans, air conditioners, transformers, and traffic from delivery trucks, employee and site vehicles. Noise line sources for the plant during operation will consist only of site vehicle traffic entering and leaving the site. Ambient background noise sources in the area include vehicle traffic along U.S. 62/180 and NM 483, low flying aircraft traffic from the Hobbs Regional Airport and existing adjacent industrial facilities.

4.7.3 Sound Level Standards

HUD guidelines set 65 dBA as the acceptable Day-Night Average Sound Level (Ldn) for areas of industrial, manufacturing, and utilities. Additionally, under these guidelines, pre-licensing and general

construction, and operation of the facility should not cause the Ldn, at a nearby residence to exceed 65 dBA (HUD, 1985). The EPA has set a goal of 55 dBA for Ldn in outdoor spaces, as detailed in the EPA Levels Document (EPA, 1973). There are no city, county or New Mexico state ordinances or regulations governing environmental noise. Thus, the IIFP site is not subject either to local or state noise regulation. Nonetheless, anticipated IIFP facility noise levels are expected to typically be below the applicable HUD and EPA guidelines and are not expected to be harmful to the public's life and health, nor a disturbance of public peace and welfare.

4.7.4 Potential Impacts to Sensitive Receptors

4.7.4.1 Impacts to the Community

Figure 4-6 shows the relationship between environmental noise and the percentage of people “highly annoyed,” annoyance being the key indicator of community response. This relationship indicates that at levels as low as the EPA’s identified Ldn of 55 dB, on the order of 3% to 4% of the exposed population will still be highly annoyed, while the percentage increases to 12 to 13% at Ldn levels of 65 dB, and 22 to 23% at Ldn levels of 70 dB (Portland, 2004).

Potential impacts to local schools, churches, hospitals, and residences are not expected to be significant, as supported by the information presented in ER Section 4.7.1. The nearest ranch is located northeast of the site at a distance of approximately 8.5 km (5.3 mi) and due to its proximity is not expected to perceive an increase in noise levels due to construction or operations. The nearest school, hospital, church and other sensitive noise receptors are beyond this distance, thereby allowing the noise to dissipate and be absorbed, helping decrease the sound levels even further. Xcel Energy Cunningham Station is located on NM 483 and Colorado Energy Station is located northeast of the site. Xcel Energy Maddox Station is located east of the facility. DCP Midstream gas processing facility is located southeast of the facility. There are no homes located near the construction traffic off NM 483 nor at the intersection of U.S. 62/180 and NM 483 to be affected by the vehicle noise; but due to existing heavy tractor trailer vehicle traffic, the change will be minimal. No schools or hospitals are located at this intersection.

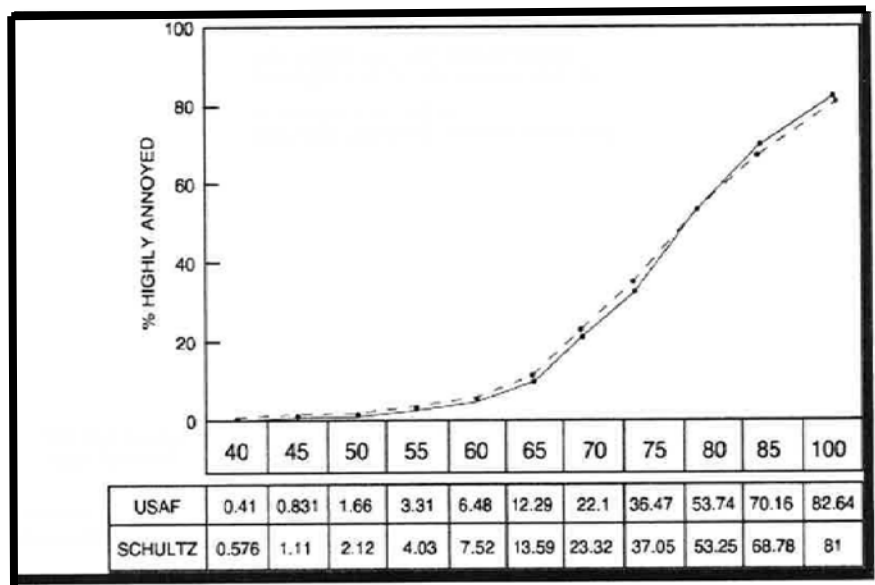

Source: Portland, 2004

Figure 4- 6 Percentage of People Highly Annoyed From Environmental Noise

4.7.4.2 Impacts to Wildlife

Although there has been significant research and findings related to noise impacts on wildlife (ASTM, 2003), there are no commonly accepted criteria for defining these noise impacts. One reference (National Research Council, 1977) states that wildlife impacts are similar to human impacts; therefore, similar impacts to those described above in ER Section 4.7.4.1 are estimated for the wildlife around the site during the various phases of the project. Impacts to Wildlife are identified as SMALL.

4.7.5 Cumulative Effects

Cumulative impacts from all site noise sources should typically remain at or below HUD guidelines of 65 dBA Ldn, and the EPA guidelines of 55 dBA Ldn, (EPA, 1973) during IIFP facility construction and operation at the boundary of the 2,369-acre Sections. The cumulative noise of all site activities should have a SMALL impact and to only those receptors closest to the site boundary.

4.7.6 Control of Noise Impacts to Community

Although much of the analysis indicates that the anticipated SMALL impacts will only be temporary (i.e., only during the IIFP facility site preparation and construction phases), and no adverse noise impacts are anticipated from the operation phase of the Proposed Action, noise mitigation will nevertheless be considered during the final planning and design phases of the project.

4.7.6.1 Construction Noise Control

There may be temporary off-site noise impacts during road construction and site preparation. During this phase of the project, noise mitigation will focus on construction activities and related operations. There are various mitigation options that will be considered for application by the contractor. Examples of this mitigation (New York City Department of Environmental Protection, 2005) are listed below:

- Equipping construction equipment with the manufacturer's noise-control devices, and maintaining these devices in effective operating condition.
- When possible, utilizing quiet equipment or methods to minimize noise emissions during an activity.
- When possible and practical, operating equipment with internal combustion engines at the lowest operating speed to minimize noise emissions.
- Closing engine housing doors during operation of the equipment to reduce noise emissions from the engine.
- Avoiding equipment engine idling.

It may be necessary to implement other noise mitigation, such as equipment-specific noise control or temporary noise barriers, if adverse impacts are observed as the project progresses.

4.7.6.2 Operation Noise Control

Although the analyses indicate that no adverse noise impacts are from the Proposed IIFP Facility operations, noise control will be considered during design and procurement, when possible to reduce sound-level impacts.

4.7.7 Comparative Noise Impacts of Alternative Actions

ER Chapter 2 provides a discussion of possible alternatives to the construction and operation of the IIFP facility, including an alternative of "No-Action," i.e., not building the IIFP facility. Additionally, IIFP considered reasonable alternatives using alternative technologies for de-conversion services and production of fluorine products.

4.7.7.1 No-Action Alternative

The DOE de-conversion facilities are sized and built to dispose of the DOE DUF₆ inventory. The de-conversion and disposal is expected to take 20 to 25 years. If DOE were to process privately owned DUF₆, de-conversion would likely have to await completion of the DOE mission or DOE would have to add additional capacity to their plants. A 20 to 25 year delay in processing the DUF₆ would force private enrichment facilities to store tails on site or to build or use their own de-conversion facilities.

The No-Action Alternative of long-term storage of DUF₆ may present potential unnecessary risk to the public. If DOE were to expand its facilities for additional capacity, additional noise impacts will be incurred at Paducah, KY and/or Piketon, OH. If the commercial enrichment facilities had to store tails indefinitely, no additional noise impacts will occur. If the Proposed Action is not implemented, there will be no noise impact to New Mexico.

4.7.7.2 Reasonable Alternatives

One of the Reasonable Alternatives considered utilization of the alternate DOE de-conversion technology on the Proposed IIFP Site near Hobbs, New Mexico. This alternative technology is the same as that which will be used in the de-conversion process utilized at the DOE sites at Paducah, KY and Piketon, OH. With this DOE technology, UF₆ reacts with water and hydrogen to produce uranium oxide, which must be disposed of as waste in a licensed facility, and aqueous HF that has a lower market value than AHF. The noise impacts of this alternative are essentially the same as the Proposed Action.

Two of the enrichment companies have de-conversion facilities overseas and could choose to ship their DUF₆ from the U.S. to those facilities for de-conversion. Those companies that do have existing overseas facilities and technologies would be required to ship DUF₆ overseas long-distances and may have to return the waste oxides to United States for licensed disposal or may have to arrange with other countries for disposal. It is expected that noise impacts for this option of shipping the DUF₆ overseas may be similar to the Proposed Action.

The four enrichment companies could decide to build and operate their own de-conversion facilities in the U.S. If those companies were to build new facilities to de-convert "tails" material, it is expected that the noise impacts for this Reasonable Alternative are expected to be similar to the Proposed Action.

See Section 4.7.7.1 for the environmental impacts on noise should the enrichment companies utilize existing DOE de-conversion facilities.

4.8 Historic and Cultural Resource Impacts

As described in Section 3.8 of this Report (Historical and Cultural Resources), a pedestrian cultural resource survey of the 259 ha (640-ac) parcel of land where the IIFP plant is to be located has been conducted (NMCRIIS, 2009). The survey was conducted to determine if any prehistoric archaeological sites are identified that are potentially eligible for the National Register of Historic Places (NRHP) and to

determine if any are located in the Area of Potential Effect (APE). The APE consists of the site and area that includes the building(s) footprints and temporary lay-down areas. The initial approach was that any potentially eligible archaeological site will either be avoided or a mitigation plan will be developed and implemented if required.

The isolated occurrences have been completely recorded in a manner consistent with current standards and do not require any additional work. A check of files yielded three previous NMCRIS activities, but no previously recorded sites within 1 km (0.62 mi) of the project area. The absence of cultural resources in the site area may be explained by the presence of shallow sediments with exposed caliche (indicating a lack of lithic raw materials), and a lack of permanent water sources. This may have made the location unattractive to prehistoric peoples. No other discoveries were made. The proposed IIFP undertaking will have a minimal impact on cultural resources.

4.8.1 Proposed Action

The Proposed Action, as described in Section 2.1, "Proposed Action," IIFP will construct and operate a facility that will use depleted UF₆ to produce inorganic fluorides, uranium oxide, and AHF. Figure 4-1 presents a schematic of the integrated facility showing the location of process buildings, roads, grounds, and other non-production facilities.

4.8.1.1 Site Preparation and Construction

No archeological sites have been identified in the area proposed for IIFP facility construction, nor have sites been identified within the access road portion of the site, where construction of a new road will be built. Thus, construction impacts to cultural and historical resources are SMALL.

4.8.1.2 Operation

Operation of the Proposed IIFP Facility is not expected to result in impacts to any potential archaeological site; therefore, impacts of facility operations on the site are expected to be SMALL for historical or cultural resources.

4.8.1.3 Decommissioning

As with pre-licensing and general construction, operation and decommissioning of the Proposed IIFP Facility will not result in impacts to any potential archaeological sites. Thus, decommissioning impacts on cultural or historical resources are SMALL.

4.8.2 Agency Consultation

The findings of the pedestrian cultural resource survey with the three isolated occurrences have been forwarded to the State Land Office. Should there be any discoveries during construction, consultation will be continued with appropriate state agencies and affected Native American Tribes.

4.8.3 Historic Preservation

The survey was conducted to determine if any prehistoric archaeological sites are identified that are potentially eligible for the National Register of Historic Places (NRHP) and to determine if any are located in the Area of Potential Effect (APE). No such sites were identified.

4.8.4 Potential for Human Remains

No human remains were discovered during the survey. There is low potential for human remains to be present on the IIFP site. Based on previous work in the region, burials tend to occur in rock shelters and on sites with structures. Should an inadvertent discovery of such remains be made during construction, IIFP will stop construction activities immediately in the area of discovery and notify the New Mexico State Historic Preservation Officer (SHPO). The SHPO will determine the appropriate measures to identify, evaluate, and treat these discoveries. If the remains are potentially from Native American sites, IIFP will, in addition to the above actions, contact the Federal Agency that has primary management authority and the appropriate Native American tribe, if known or readily ascertainable. IIFP will also make reasonable effort to protect the items discovered before resuming the construction activities in the vicinity at the discovery. The construction activity will resume only after the appropriate consultations and notifications have occurred and guidance received.

4.8.5 Minimizing Adverse Impacts

If any eligible historic properties are located within the APE of the proposed location of the IIFP facility, a treatment/mitigation plan will be developed to recover any significant information from any eligible archaeological sites identified on the IIFP site. Mitigation measures will be in place to minimize any potential impact on historical and cultural resources. In the event that any inadvertent discovery of human remains or other item of archeological significance is made during construction, the facility will cease construction activities immediately in the area of discovery and notify the SHPO to make the determination of appropriate measures to identify, evaluate, and treat these discoveries.

Given the small number of potential archaeological sites and IIFP's ability to avoid or mitigate impacts to those sites, the IIFP project will not have a significant impact on historic and cultural resources.

4.8.6 Cumulative Impacts

Given the small number of potential archaeological sites, there will be no cumulatively significant impacts to cultural resources.

4.8.7 Comparative Historical and Cultural Resource Impacts of Alternative Scenarios

ER Chapter 2 provides a discussion of possible alternatives to the construction and operation of the IIFP facility, including an alternative of "No-Action," i.e., not building the IIFP facility. Additionally, IIFP considered reasonable alternatives using alternative technologies for de-conversion services and production of fluorine products.

4.8.7.1 No-Action Alternative

The DOE de-conversion facilities are sized and built to dispose of the DOE DUF₆ inventory. The de-conversion and disposal is expected to take 20 to 25 years. If DOE were to process privately owned DUF₆, de-conversion would likely have to await completion of the DOE mission or DOE would have to add additional capacity to their plants. A 20 to 25 year delay in processing the DUF₆ would force private enrichment facilities to store tails on site or to build or use their own de-conversion facilities.

The No-Action Alternative of long-term storage of DUF₆ may present potential unnecessary risk to the public. If DOE were to expand its facilities for additional capacity, additional historical and cultural impacts will be incurred at Paducah, KY and/or Piketon, OH. If the commercial enrichment facilities had

to store tails indefinitely, no additional historical and cultural impacts will occur. If the Proposed Action is not implemented, there will be no historical and cultural impact to New Mexico.

4.8.7.2 Reasonable Alternatives

One of the Reasonable Alternatives considered utilization of the alternate DOE de-conversion technology on the Proposed IIFP Site near Hobbs, New Mexico. This alternative technology is the same as that which will be used in the de-conversion process utilized at the DOE sites at Paducah, KY and Piketon, OH. With this DOE technology, UF_6 reacts with water and hydrogen to produce uranium oxide, which must be disposed of as waste in a licensed facility, and aqueous HF that has a lower market value than AHF. The historical and cultural impacts of this alternative are essentially the same as the Proposed Action.

Two of the enrichment companies have de-conversion facilities overseas and could choose to ship their DUF_6 from the U.S. to those facilities for de-conversion. Those companies that do have existing overseas facilities and technologies would be required to ship DUF_6 overseas long-distances and may have to return the waste oxides to United States for licensed disposal or may have to arrange with other countries for disposal. It is expected that historical and cultural impacts for this option of shipping the DUF_6 overseas may be similar to the Proposed Action.

The four enrichment companies could decide to build and operate their own de-conversion facilities in the U.S. If those companies were to build new facilities to de-convert “tails” material, it is expected that the historical and cultural impacts for this Reasonable Alternative are expected to be similar to the Proposed Action.

See Section 4.8.7.1 for the environmental impacts on historical and cultural should the enrichment companies utilize existing DOE de-conversion facilities.

4.9 Visual/Scenic Resources Impacts

4.9.1 Photos

Figure 4-7, “DCP Midstream Pipeline Junction”

Figure 4-8, “Aerial 3-Dimensional View of the IIFP Concept Plant”

Figure 4-9, “Xcel Lines Going Northeast”

Figure 4-10, “PMN Gas Services Line Going Northwest and Southwest Looking Southwest”

Figure 4-11, “Caliche Road Looking West Through Approximate Center”

Figure 4-12, “Caliche Pit in Southeast Corner of Section Looking North”

Figure 4-13, “DCP Midstream Fluid Tank at Center of West Side of Section”

Figure 4-14, “Pipeline PNM Gas Services Facility in Approximate Center of Section”

4.9.2 Proposed Action

The Proposed Action, as described in Section 1.2, “Proposed Action,” IIFP will construct and operate a facility that will use depleted UF_6 to produce inorganic fluorides, uranium oxide, and anhydrous hydrofluoric acid. Figure 4-1 presents a schematic of the integrated plant showing the location of process buildings, roads, grounds, and other non-production facilities. The proposed site is remote from any population centers or neighbors and is set over 3,000 feet from the nearest highway (NM 483).

4.9.2.1 Site Preparation and Construction

The construction of the Proposed IIFP Facility will require clearing of vegetation from the site; however, the amount of vegetation cleared will be limited, to the extent practicable, to the land area needed for the Proposed IIFP Facility's operational, security, and utility requirements. Approximately 16.2 ha (40 ac) of land will be cleared for the Proposed IIFP Facility and approximately an additional 2 ha (5 ac) adjacent to the site for a lay-down area.

Temporary visual intrusions into the landscape may result from the use of construction cranes at the IIFP Site for erecting building structures and installing equipment. No other visual/scenic resource impacts are expected to result from the activities performed for construction of the Proposed IIFP Facility; therefore, the visual/scenic resource impacts resulting from construction of the Proposed IIFP Facility will be SMALL.

4.9.2.2 Operation

The layout of the Proposed IIFP Facility is shown in Figure 4-1. The dominant structure for Proposed IIFP Facility that potentially could create visual intrusions into the landscape will be the main operations buildings. The tallest building is the DUF₄ processing facility: the height of which is approximately 21.3 m (70 ft) tall. A few gaseous emission stacks will be 100 ft in height around the process buildings. The visual/scenic resource impacts resulting from operation of the Proposed IIFP Facility are SMALL.

4.9.2.3 Decommissioning

Decommissioning of the Proposed IIFP Facility will involve removal and decontamination of the used process equipment and materials from building interiors and from outdoor storage areas. Some of the structures, including the main IIFP operations buildings, access roads, and utility lines built for the Proposed IIFP Facility, could remain in place after closure. Thus, no additional changes to the visual/scenic resource impacts are expected due to the decommissioning of the Proposed IIFP Facility; the visual/scenic resource impacts resulting from decommissioning of the facility will be SMALL.

4.9.3 Aesthetic and Scenic Quality Rating

The visual resource inventory process provides a means for determining visual values (BLM, 1984). The inventory consists of a scenic quality evaluation, sensitivity level analysis, and a delineation of distance zones. Based on these three factors, lands are placed into one of four visual resource inventory classes. These inventory classes represent the relative value of the visual resources as follows: Classes I and II are considered to have the highest value, Class III represents a moderate value, and Class IV is of least value. The inventory classes provide the basis for considering visual values in the resource management planning (RMP) process. Visual resource management classes are established through the RMP process.

Scenic quality is a measure of the visual appeal of a tract of land which is given an A, B or C rating (A-highest, C-lowest) based on the apparent scenic quality. The IIFP site, as evaluated based on the scenic quality of the site receives a "C" rating and falls into class IV. Class IV is of the least value and allows for manipulation or disturbance. The proposed use of the IIFP site is within the objectives for Class IV, which is to provide for management activities that require major modifications of the existing character of the landscape. Therefore, land management activities may dominate the view and be the major focus of viewer attention. The level of change to the characteristics of the landscape can be high (BLM, 1984; BLM, 1986). With the existing gas-related structures, power lines, and other distractions typical as shown

in Figure 4-7, the impact of the Proposed IIFP Facility will not significantly change the character of the landscape.



Source: BBCI, 2009

Figure 4- 7 DCP Midstream Pipeline Junction

4.9.4 Significant Visual Impacts

Figure 4-1 is a layout of the IIFP Integrated Plant. The plant occupies 16.2 ha (40 ac) and is surrounded by the 259-ha (640-ac) Section. Open rangeland lies around the 640-acre Section interspersed with oil and gas service facilities and the industries.

Xcel Energy Maddox Station and the Hobbs Regional Airport are located to the east of the IIFP facility. Immediately west of the site is Xcel Energy Cunningham station which borders the Section. The DCP Midstream Facility is located ESE along U.S. 62/180. The Colorado Generating Station is northeast of the IIFP facility. See Figure 2-5, “IIFP Site Map with Surrounding Industrial Properties.” Numerous power lines (See Figure 4-8, “Xcel Lines Going Northeast”), buried pipelines (See Figure 4-9, “PMN Gas



Source: BBCI, 2009

Figure 4- 8 Xcel Lines Going Northeast



Source: BBCI, 2009

Figure 4- 9 PMN Gas Services Line Going Northwest and Southwest Looking Southwest

Services Line Going Northwest and Southwest Looking Southwest”), and a two-track road between the two Excel Energy companies are present throughout the IIFP site Also see Figure 4-10, “Caliche Road Looking West Through Approximate Center.”

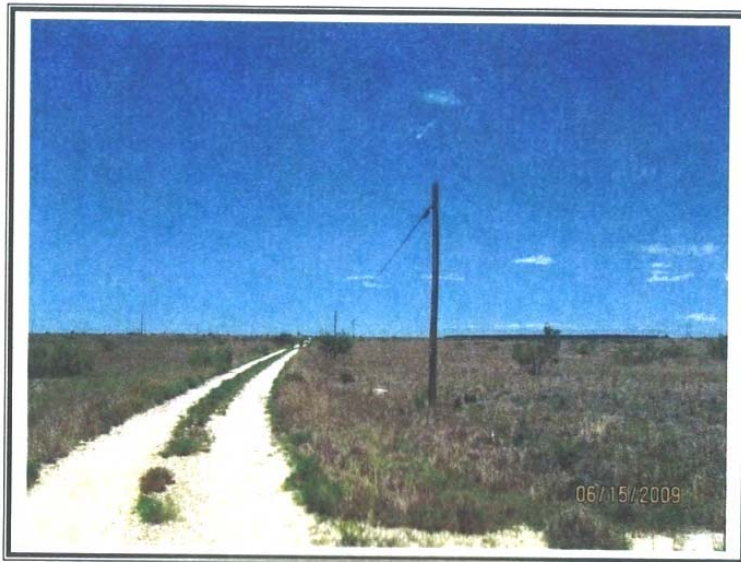

Source: BBCI, 2009

Figure 4- 10 Caliche Road Looking West Through Approximate Center

One area has been utilized as a gravel pit crusher site. See Figure 4-11, “Caliche Pit in Southeast Corner of Section Looking North.”

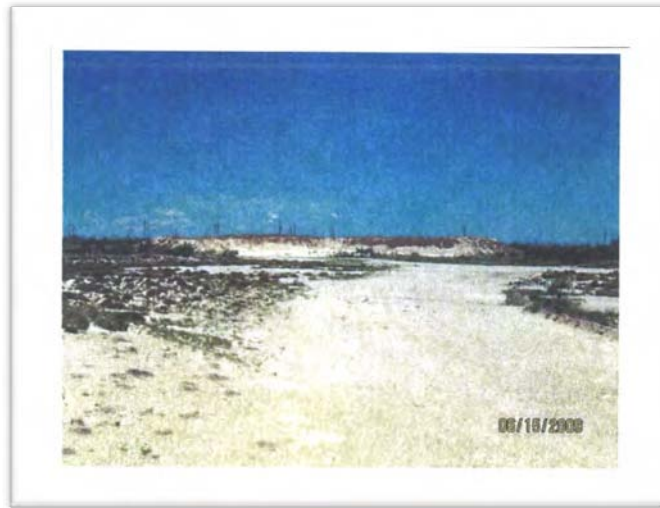

Source: BBCI, 2009

Figure 4- 11 Caliche Pit in Southeast Corner of Section Looking North

The Proposed IIFP Facility is not out of character with current, on-site conditions due to the presence of various gas and oil industry facilities. As an example, see Figure 4-12, “DCP Midstream Fluid Tank at Center of West Side of Section,” and Figure 4-13, “Pipeline PNM Gas Services Facility in Approximate Center of Section.”

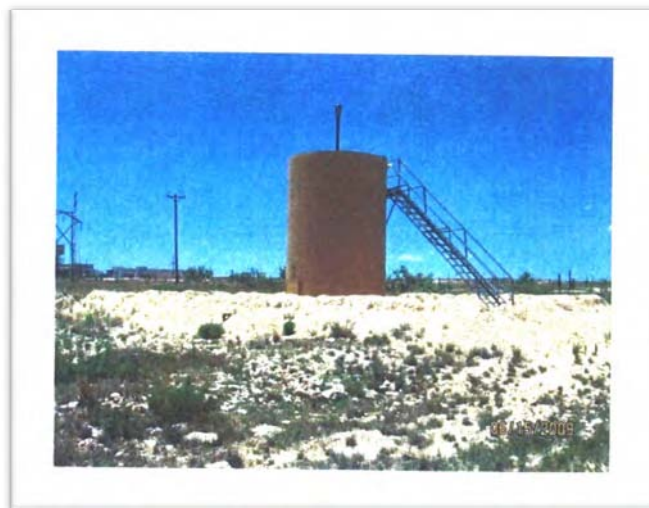

Source: BBCI, 2009

Figure 4- 12 Midstream Fluid Tank at Center of West Side of Section



Source: BBCI, 2009

Figure 4- 13 Pipeline PNM Gas Services Facility in Approximate Center of Section

4.9.4.1 Physical Facilities Out of Character with Existing Features

However, considering the neighboring properties have been developed for industrial purposes (three power companies and a natural gas processing facility); the proposed plant structures are similar to

4.9.4.2 Structure Obstructing Existing Views

The tallest proposed on-site building is projected to be approximately 21.3 m (70 ft). However, relatively small-diameter emission stacks will be approximately 30.5 m (100 ft) tall. Due to the relative flatness of the site and vicinity, the structures will be observable from U.S. 62/180 and NM 483 and from the nearest neighbor at approximately 8.5 km (5.3 mi) from the site. The IIFP buildings will partially obstruct views of existing landscape. However, considering that there are no high quality viewing areas (see ER Section 3.9.7, “High Quality View Areas”) and the many existing, manmade structures (pump jacks, high power lines, industrial buildings, above-ground tanks) near the IIFP facility, the obstruction of existing views due to proposed structures will not degrade current conditions. (Refer to ER Figures in Section 3.9.2.)

4.9.4.3 Structures Creating Visual Intrusions

Although all the proposed IIFP structures will be set back a substantial distance from U.S. 62/180 and NM 483, taller plant structures will likely be visible from the highway and adjacent properties, creating a visual intrusion. However, considering the existing structures associated with neighboring industrial properties, the nearby utility poles along U.S. 62/180 and NM 483, the high-power utility lines, the related gas industry structures already on the site, and the numerous pump jacks dotting the landscape all around the site as shown in Figure 4-14, the proposed on-site structures will be no more intrusive.



Figure 4- 14 Pumpjack in Southeastern New Mexico

4.9.4.4 Structures Requiring the Removal of Barriers, Screens or Buffers

With the possible exception of the access road from the west boundary, none of the on-site structures will require removal of natural barriers, screens or buffers. Any removal of natural barriers, screens or buffers associated with road construction will be minimized. Additionally natural landscape, using vegetation indigenous to the area, is planned to provide additional aesthetically pleasing screening measures.

4.9.4.5 Altered Historical, Archaeological or Cultural Properties

Cultural or archaeological sites that might be found within the Proposed IIFP Site can either be avoided or successfully mitigated, if required. If necessary, a treatment/mitigation plan will be developed by IIFP to recover any significant information from all sites that will be eligible for listing on the NRHP. As a result, no historical, archaeological or cultural properties will be affected by development of the IIFP plant.

4.9.4.6 Structures that Create Visual, Audible or Atmospheric Elements Out of Character

Although the proposed on-site structures are out of character with the natural setting of the site, they will not degrade the visual elements of the area due to existence of surrounding industrial properties as well as gas/oil service facilities on the site. None of the IIFP structures or associated activities will typically produce significant noise levels audible off site (see ER Section 4.7.1, “Predicted Noise Levels”) or create significant atmospheric elements (such as large emission plumes) visible from off site.

4.9.5 Visual Compatibility and Compliance

Applicable local ordinances and regulations will be followed during the construction and operation of the IIFP plant. Development of the site will meet federal and state requirements for nuclear and radioactive material sites regarding design, siting, construction materials, and monitoring.

4.9.6 Cumulative Impacts to Visual/Scenic Quality

The cumulative impacts to the visual/scenic quality of the IIFP site can be assessed by examining Proposed Actions associated with construction of the IIFP facility and considering other industrial facilities on surrounding properties.

Proposed site development potentially impacting the visual/scenic quality of the IIFP site includes:

- Several buildings surrounded by chain link fencing,
- Gaseous emission stacks [approximately 30.5 m (100 ft) tall],
- New power lines, and
- New access road.

Existing development on surrounding properties impacting the visual/scenic quality of the site and vicinity includes:

- Industrial structures from 3 power companies and a natural gas processing station (buildings, aboveground tanks),
- Man-made earthen structures (industrial lagoons, stockpiled soil, landfill cavities),
- Caliche covered roadways,
- Power poles and a high-voltage utility lines,
- Pump jacks, and
- Barbed wire fencing along property perimeters.

By considering both proposed on site and nearby existing developments, modification to the subject site will not significantly degrade its visual/scenic character. Therefore, there is a SMALL cumulative impact on the visual/scenic quality of the IIFP site.

4.9.7 Comparative Visual/Scenic Resources Impacts of No-Action Alternative

ER Chapter 2 provides a discussion of possible alternatives to the construction and operation of the IIFP facility, including an alternative of "No-Action," i.e., not building the IIFP facility. Additionally, IIFP considered reasonable alternatives using alternative technologies for de-conversion services and production of fluorine products.

4.9.7.1 No-Action Alternative

The DOE de-conversion facilities are sized and built to dispose of the DOE DUF₆ inventory. The de-conversion and disposal is expected to take 20 to 25 years. If DOE were to process privately owned DUF₆, de-conversion would likely have to await completion of the DOE mission or DOE would have to add additional capacity to their plants. A 20 to 25 year delay in processing the DUF₆ would force private enrichment facilities to store tails on site or to build or use their own de-conversion facilities.

The No-Action Alternative of long-term storage of DUF₆ may present potential unnecessary risk to the public. If DOE were to expand its facilities for additional capacity, additional visual/scenic impacts will be incurred at Paducah, KY and/or Piketon, OH. If the commercial enrichment facilities had to store tails indefinitely, no additional visual/scenic impacts will occur. If the Proposed Action is not implemented, there will be no visual/scenic impact to New Mexico.

4.9.7.2 Reasonable Alternatives

One of the Reasonable Alternatives considered utilization of the alternate DOE de-conversion technology on the Proposed IIFP Site near Hobbs, New Mexico. This alternative technology is the same as that which will be used in the de-conversion process utilized at the DOE sites at Paducah, KY and Piketon, OH. With this DOE technology, UF_6 reacts with water and hydrogen to produce uranium oxide, which must be disposed of as waste in a licensed facility, and aqueous HF that has a lower market value than AHF. The visual/scenic impacts of this alternative are essentially the same as the Proposed Action.

Two of the enrichment companies have de-conversion facilities overseas and could choose to ship their DUF_6 from the U.S. to those facilities for de-conversion. Those companies that do have existing overseas facilities and technologies would be required to ship DUF_6 overseas long-distances and may have to return the waste oxides to United States for licensed disposal or may have to arrange with other countries for disposal. It is expected that visual/scenic impacts for this option of shipping the DUF_6 overseas may be similar to the Proposed Action.

The four enrichment companies could decide to build and operate their own de-conversion facilities in the U.S. If those companies were to build new facilities to de-convert "tails" material, it is expected that the visual/scenic impacts for this Reasonable Alternative are expected to be similar to the Proposed Action.

See Section 4.9.7.1 for the environmental impacts on visual/scenic should the enrichment companies utilize existing DOE de-conversion facilities.

4.10 Socioeconomic Impacts

This section describes the socioeconomic impacts to the community surrounding the IIFP plant, including the impacts from the-influx of the construction and operation work force to schools and housing as well as on social services. Transportation impacts are described in ER Section 4.2, "Transportation Impacts."

4.10.1 Facility Construction

Pre-licensing construction activities are assumed to begin in early 2011 and to conclude in the fall of 2011 when NRC is expected to approve the IIFP license. Pre-licensing construction activities, described in Section 4.1.1.1, "Construction Impacts," will be preparatory in nature and will not involve any process or safety related equipment or systems. IIFP Site general construction is scheduled to begin in 2011, with construction continuing into 2012. The maximum construction workforce during Phase 1 is anticipated to range from 120 to 140 workers during the 2011-2012 period. Construction of Phase 2 is scheduled to be accomplished in 2016 with an average construction crew of 150 to 180 workers.

4.10.1.1 Worker Population

During the pre-licensing construction stages of the project, the work force is expected to consist primarily of structural crafts, which should benefit the local area since this workforce is expected to come from the local area. As construction progresses, there will be a transition to predominantly mechanical and electrical crafts in the later stages. The bulk of this labor force is expected to come from the surrounding 120-km (75-mi) region due to the relatively low population of the local site area (See Table 3-39, Employment in the Region of Influence for Census Year 2000 and Table 3-44, Income Levels for the Nine-County Region in Census Year 2000).

The available labor pool is expected to correlate with the required education and skill levels for the construction work force.

The southeast New Mexico area's ability to supply ample labor is enhanced by an excellent rural road system and warm climate. These factors allow an employer to draw from a wide geographic area labor force.

4.10.1.2 Impacts of Human Activities

The major impact of facility construction on human activities is expected to be a result of the influx of labor into the area on a daily or semi-permanent basis. IIFP estimates approximately 30 workers of the construction work force are expected to move into the vicinity as new residents (15% of 200 workers). Previous experience regarding construction for the nuclear industry projects suggests that of those who move, approximately 65% will bring their families, which on average consist of the worker, a spouse, and one school-aged child (NRC, 1994). The likely increases in area population during construction, therefore, will total about 70. This is less than 0.1% of the total Lea County, New Mexico population for 2008 or 0.03% for the nine-county region of influence (Refer to Table 3-33, "Population Levels in the Region of Influence").

Additionally, Hobbs had a population of 29,602 in 2007 and is projected to have a growth rate of 1.17% through 2015. See Figure 4-15, "Hobbs, NM Population Projections." Again, the influx of workers for the construction of the IIFP plant and the operation of the facility will be of minimal impact to the local human activities based on this projected growth just at Hobbs. Phase 2 population increases due to construction should generally be half of that anticipated for the Phase 1 construction.

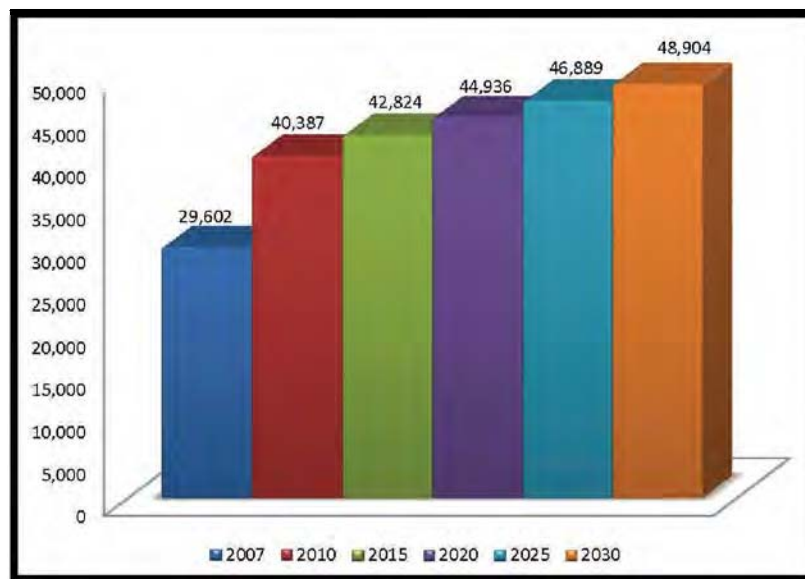

Source: EDCLC, 2009b

Figure 4- 15 Hobbs NM Population Projections

The increase in jobs and population will lead to a need for additional housing and an increased level of community services, such as schools, fire and police protection, and medical services. Providers of these services should be able to accommodate the growth. For example, the estimated peak increase in school-age children is 20 or 0.1% for Lea County school enrollment only (Refer to Table 3-49, "Education

Characteristics in the Region of Influence for Census Year 2000”). The overall change in population density and population characteristics in Lea County, New Mexico and the other 8 counties in the region of influence, due to construction of the IIFP facility, are SMALL.

Similarly, IIFP has estimated 20 housing units will be needed to accommodate the new IIFP facility construction workforce. The percentage of vacant housing units in the Lea County, New Mexico and the region of influence in 2000 was about 16% and 14%, respectively, meaning that more than 3,700 housing units were available in Lea County and that over 12,600 housing units were available in the region of influence (Refer to Table 3-46, “Housing in the Region of Influence around the IIFP Site for Census Year 2000”). Accordingly, there should be no significant impact related to the need for additional housing for Phase 1 or Phase 2 construction.

Approximately \$70 to \$94 million capital costs will be spent for the Phase 1 construction of the IIFP facility. See Table 4-19, “Summary of Capital Cost Estimate for Phase 1 FEP/DUP Facility.” An additional \$42 to \$57 million will be required to expand the plant to Phase 2 for a combined capital investment of \$112 to \$151 million.

Table 4- 19 Summary of Capital Cost Estimate for Phase 1 and Phase 2 FEP/DUP Facility

Fixed Capital	Phase 1 Estimated Costs in Millions (\$)	Incremental Phase 2 Costs in Millions (\$)	Total Phase 1 and Phase 2 Estimated Costs in Millions (\$)
DUF ₄ Plant	9-12	0	9-12
FEP Plant	15-19	0	15-19
Oxide Add-on Plant	N/A	26-34	26-34
Balance of Plant	15-20	1-1.5	16-21.5
Engineering, Procurement, Construction Management (EPCM)	7-11	7-9	14-20
Project Mgt & Programs	2-3	1-1.5	3-4.5
Contractor Fees	2-3	1-2	3-5
Contingency	5-6	3-4	8-10
Subtotal Capital (Expressed in 2009 \$)	55-74	39-52	94-126
Development/Startup Expenses			
Regulatory, License, Permits	3-4	1-1.5	4-5.5
Pre-startup Working Capital	9-12	1-2	10-14
Spare Parts/Start up Inventories	3-4	1-1.5	4-5.5
Subtotal Development/Startup Exp.	15-20	3-5	18-25
Total Estimated Capital, Development and Startup (in 2009 \$)	70-94	42-57	112-151

While some additional investment in facilities and equipment may be necessary, local government revenues will also increase. These benefits and payments will provide the source for additional government investment in facilities and equipment. That revenue increase may lag somewhat behind the need for new investment, but the incremental nature of the growth should allow local governments to more easily accommodate the increase. Negative impacts on community services are expected to be insignificant. However, positive impacts to the regional economy will result from the Proposed Action.

4.10.2 Facility Operation

4.10.2.1 Jobs, Income, and Population

Operation of the proposed IIFP plant will lead to a permanent increase in employment, income, and population in the area. Employment at the IIFP facility during operation will be about 120 to 140 workers during Phase 1 and increase to 150 to 180 during Phase 2 operations. This is less than a 0.9% increase in total employment in Lea County and 0.25 % for the nine-county region of influence (Refer to Table 3-39). A 4% increase in manufacturing employment is expected in the three New Mexico counties (reference Table 3-41). For Hobbs, according to the New Mexico Department of Labor, by 2014, the most significant employment increase will occur in the industries shown in Figure 4-16. The construction and the operation of the IIFP facility will compete for workers in 50% of the categories depicted in Figure 4-16. A significant number of operational jobs are likely to be filled by residents in the region since most of its populace has completed school attainment at or above the high school grade level (Refer to Table 3-49, Table 3-50, Table 3-51 and Figure 3-79).

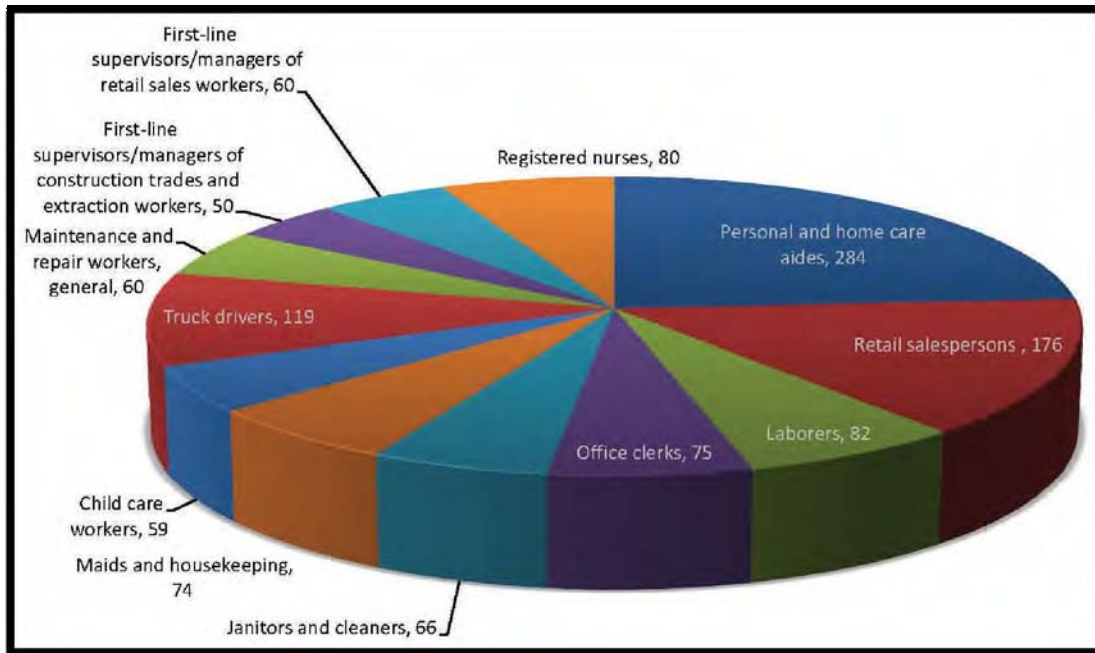

Source: EDCLC, 2009b

Figure 4- 16 Job Growth Projections for Hobbs, New Mexico by 2014

Additionally, the New Mexico Junior College (NMJC) and the College of the Southwest are located in Hobbs. As can be seen in Figure 4-17 enrollment in NMJC has been increasing in the Workforce Training Enrollment while the Fall Credit headcount has been declining. The Workforce Training headcount grew fourteen-fold from 360 trainees in the 2003 school year to 5,000 trainees in the 2006 school year. The change in the enrollment mix at the NMJC underscores the need for specific skill sets in Lea County's evolving labor market (BBER, 2007a).

For the Phase 1 facility, the IIFP annual operating payroll will be approximately \$7.9 to \$9.1 million for a workforce of approximately 120-138. The combined annual operating payroll for the Phase 1 and Phase 2 facilities will be approximately \$9.6 to \$10.5 million for a workforce of 145 to 160 personnel. Table 4-20,

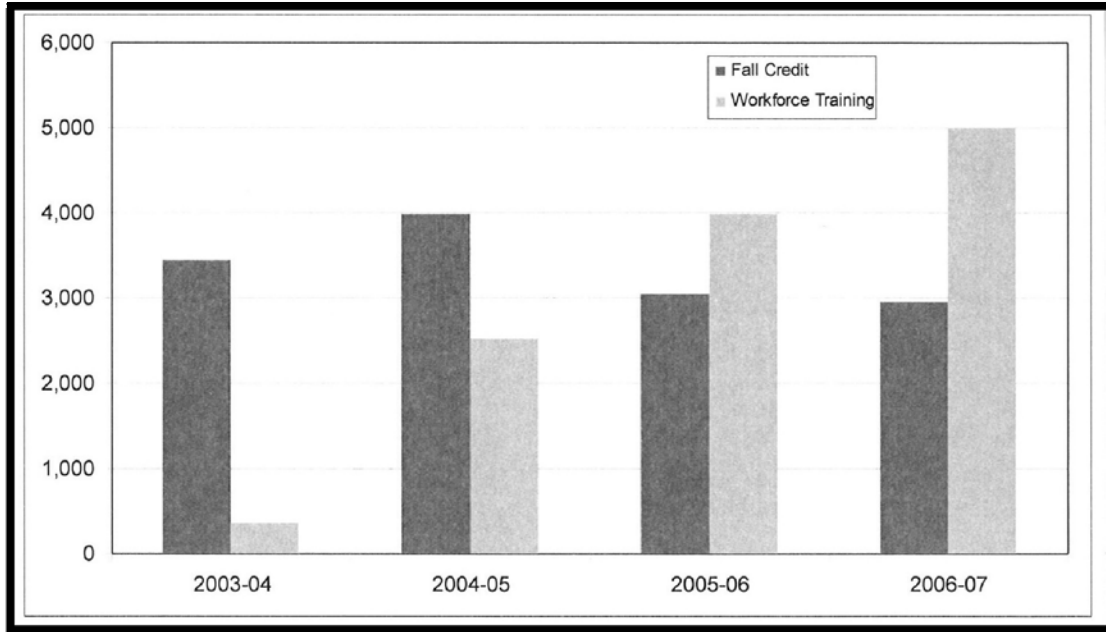

BBER, 2007a

Figure 4- 17 New Mexico Junior College Fall Credit and Workforce Training Enrollment

Table 4- 20 Plant Estimated Labor for Plant Personnel

Personnel Classification	Approximate No. Required			Annual Costs (\$)	
	Phase 1	Phase 2 Incremental	Phase 2 Total	Phase 1	Phase 2 Total
Hourly-Operations	45-50	10	55-60	2,650,000– 2,980,000	3,300,000- 3,600,000
Hourly-Maintenance	35-40	10	45-50	2,060,000– 2,320,000	2,650,000- 2,950,000
Salary Employees	40-48	2-5	45-50	3,200,000– 3,800,000	3,600,000- 4,000,000
Total	120-138	22-25	145-160	7,910,000- 9,100,000	9,550,000- 10,500,000

“Plant Estimated Labor for Plant Personnel,” provides the breakout of the payroll by position types and annual costs by position types. The resultant average salary is approximately 68% greater than the median household income in Lea County New Mexico, and for Andrews/Gaines Counties, Texas area and approximately 47% and 64.3% above the median household income for those counties, respectively (Refer to Table 3-44).

An increase in the number of jobs will also lead to a population increase in the surrounding areas. Lea and Gaines Counties probably will experience the most noticeable population increases. The population increase during operations of the facility will be less than during facility construction and, accordingly, have a lower impact. In particular, the region will avoid a boomtown effect, which generally describes the consequence of rapid increases in population (at least 5 to 10% per year) in small (populations of a few thousand to a few tens of thousands), rural 48 to 80 km (30 to 50 mi) or more from major city communities undergoing rapid increases in economic activity (NRC, 1994). The overall change in

population density and population characteristics in Lea County, New Mexico and Andrews/Gaines Counties, Texas due to operation of the IIFP facility is SMALL.

The impact estimates provided in ER Sections 4.10.1 and 4.10.2 are based on the assumption that impacts are limited to Lea, Andrews, and Gaines counties. If the projected increase in population reported in ER Sections 4.10.1 and 4.10.2 were spread over the 9-county region of influence, the impact will be reduced due to the higher population. This is the case for both the construction and operation periods. This minor increase in population will produce a SMALL impact on population characteristics, economic trends, housing, community services (health, social and educational resources), and the tax structure and distribution within 120 km (75 mi) of the site during both the construction and operation period.

As shown in Table 3-33, the population of Lea County, New Mexico was approximately 55,511 in 2000. The three closest population centers to the site in Lea County are Eunice at 34 km (21 mi), Hobbs at 23 km (14 mi), and Jal at 69 km (43 mi). The populations of these three areas in 2000 were approximately 2,562, 28,657, and 1,996, respectively, providing a combined total population of approximately 33,215. If the entire construction phase population with a maximum increase of approximately 200 reported in ER Section 4.10.1.2 is assumed to relocate to these three areas, a total construction phase population increase of approximately 0.6% will result. For a highest impact scenario, if all the construction workers for the pre-licensing and general construction, and Phase 2 construction relocated to the area, then the population will increase by 1.4%.

As shown in Table 3-33, the population of Andrews County, Texas, was approximately 13,004 in 2000. The two closest population centers in Texas to the site are Andrews at 85 km (53 mi) and Seminole at 47 km (29 mi) each. The populations of these two areas in 2000 were 9,652 and 5,910, respectively. It is reasonable to assume that the population increase due to the IIFP construction and operation will mostly relocate to this representative set of nearby population centers: Eunice, Hobbs and Jal, New Mexico, and Andrews and Seminole, Texas. All five locations are within 85 km (53 mi) of the site and are reasonable commuting distances for this region of the country. These five areas have a combined population of 48,777. If the maximum construction phase population increase of 200 is assumed to relocate to all five of the nearby locations (Eunice, Hobbs, Jal, Andrews, and Seminole), a total construction phase population increase of approximately 0.4% will result. For a highest impact scenario, if all the construction workers for the pre-licensing and general construction, and Phase 2 construction relocated to the area, then the population will increase by 0.9%. A significant number of operational jobs are likely to be filled by residents already living in the region. Therefore, the population increase during operation of the proposed IIFP plant will be less than during facility construction since fewer workers are expected to relocate to the area. The small population increase of the maximum 200 during the construction phase is not expected to have a significant impact on the area. Because the population increase during operation of the Phase 2 facility is expected to be somewhat smaller at 145 to 160 personnel than the expected population increase during construction, a similar conclusion applies concerning the impact on the area during the operational period of the IIFP facility.

The minor increase in population will produce a SMALL impact on population characteristics, economic trends, housing, community services (health, social and educational resources), and the tax structure and distribution within Hobbs, Lovington, and Eunice, New Mexico, and Andrews and Seminole, Texas, during both the construction and operation periods of the IIFP plant.

4.10.2.2 Community Characteristic Impacts

The increase in population due to IIFP operation, as stated above, will be less than during construction. Based on the housing vacancy rate in the area, which is about 3% to 5% higher than the respective states

in general (Refer to Table3 3-46, 3-47, and 3-48), the relatively small need for housing units is not anticipated to burden or raise prices within the local real estate market.

Similarly, a smaller increase in local elementary and secondary school enrollment will be expected during operation as compared to that during construction. Area medical, fire, and law enforcement services should be minimally affected as well. Agreements exist among the cities in Lea County, New Mexico, for emergency services if personnel in Hobbs, New Mexico are not available. IIFP will request support from the local police and fire departments as well as the State police if needed. The impact to community characteristic is SMALL.

4.10.3 Decommissioning

For this analysis, it is assumed that decommissioning of the Proposed IIFP Facility will begin in 2049 and will last approximately 3 years, with the first year being essentially a planning period that overlaps with the final 2 years of operations. The decommissioning process will consist of decontaminating and removing equipment from the facility, while leaving the building, parking area, and access roads in place. IIFP estimates that these activities will be carried out by an annual workforce of 40 full time equivalents (FTE). The impact these workers will have on the population level of the region is difficult to quantify.

4.10.3.1 Impact of Decommissioning on Population

No reliable information could be obtained regarding labor market conditions over 40 years in the future; therefore, it is not apparent how many of the 40 jobs will be filled by individuals living in the region. Since operation of the Proposed IIFP Facility will end in 2050 (unless its license is renewed), it is not clear what will happen to the approximately 180 workers employed for facility operations. Some of them might choose to stay inside the region, whereas others may move to other parts of the country. If most of them chose to leave the region, the total population could decline even if all 40 decommissioning workers came from outside the region. Finally, population projections are not available past the year 2030; therefore, even if this analysis were able to accurately estimate the net population change during decommissioning, there will not be an appropriate baseline for comparison.

Despite these limitations, it seems likely that the impact of decommissioning on the regional population level will be SMALL. For example, even if all 40 decommissioning-phase workers came from outside the region and brought one spouse and one child, this unlikely possibility will only result in a population increase of 120 individuals in 2049. Considering that population will likely continue to grow between before 2050, it is likely that the impact of introducing 120 additional individuals to the region during decommissioning will be even minimal. As a result, this analysis concludes that population impacts of decommissioning of the Proposed IIFP Facility will be SMALL.

4.10.3.2 Economic Impact of Decommissioning

Closing the operation of the IIFP facility for decommissioning has an obvious impact to the community some of which will be offset by a few years of decommissioning work and site closure. However, the decommissioning strategy is to leave most of the infrastructure for unrestricted use, which would provide the community an opportunity to potentially benefit from other industrial or business uses.

Combining individual income and sales taxes, it is estimated that the decommissioning of the Proposed IIFP Facility will generate approximately \$560,000 per year. This corresponds to \$1.7 million of cumulative State and local tax revenue over the 3-year decommissioning period. The overall net

economic impacts of the decommissioning phase of the Proposed IIFP Facility are estimated to be SMALL.

4.10.3.3 Impact on Social Services

There are several reasons to believe that the decommissioning of the Proposed IIFP Facility will not adversely affect the social infrastructure of the region. First, since the decommissioning of the Proposed IIFP Facility is relatively far into the future, economic planners and community leaders will have time to prepare for its potential impacts. Second, decommissioning will last a relatively short amount of time—approximately 3 years. As a result, supporting this activity should not require a permanent adjustment in social infrastructure, such as building new hospitals or schools. Based on these factors, it is assumed that decommissioning will have a SMALL impact on the provision of social services in the region.

4.10.4 Cumulative Socioeconomic Impacts

Significant benefits to the local, regional and state communities are derived from the capital investment expenditures and recurring operations. Table 4-21 presents a summary of estimated economic benefits expected to be realized by the regional community and state as a result of facility construction and operation dollars being expended within the respective surrounding geographical region.

4.10.5 Comparative Socioeconomic Impacts of No-Action Alternative Scenarios

ER Chapter 2 provides a discussion of possible alternatives to the construction and operation of the IIFP facility, including an alternative of "No-Action," i.e., not building the IIFP facility. Additionally, IIFP considered reasonable alternatives using alternative technologies for de-conversion services and production of fluorine products.

Table 4- 21 Estimated Economic Benefits to Region (Local and State) Surrounding the IIFP

Category	Annual Benefits (in 2009\$)	Annual Benefits Normalized for 40-Yr Period (in 2009\$)
Construction Labor	7,400,000-11,300,000 (for 6.5 years)	1,200,000-1,840,000
Construction Materials	1,740,000-2,600,000 (for 6.5 years)	280,000-420,000
Replacement Capital	1,500,000-2,100,000	1,500,000-2,100,000
Operating Labor Wages/Salaries	7,900,000-9,100,000 (Phase 1) 9,500,000-10,500,000 (Phase 2)	8,800,000-10,400,000
Waste Disposal Fees in State	15,000-27,000	15,000-27,000
Insurance Premiums & Taxes	12,500,000-17,000,000	12,500,000-17,000,000
Utilities	2,500,000-3,300,000	2,500,000-3,300,000
Maintenance Materials & Supplies	800,000-1,300,000	800,000-1,300,000
TOTAL		27,595,000-36,387,000

4.10.5.1 No-Action Alternative

The DOE de-conversion facilities are sized and built to dispose of the DOE DUF₆ inventory. The de-conversion and disposal is expected to take 20 to 25 years. If DOE were to process privately owned DUF₆, de-conversion would likely have to await completion of the DOE mission or DOE would have to add additional capacity to their plants. A 20 to 25 year delay in processing the DUF₆ would force private enrichment facilities to store tails on site or to build or use their own de-conversion facilities.

The No-Action Alternative of long-term storage of DUF₆ may present potential unnecessary risk to the public. If DOE were to expand its facilities for additional capacity, additional socioeconomic impacts will be incurred at Paducah, KY and/or Piketon, OH. If the commercial enrichment facilities had to store tails indefinitely, no additional socioeconomic impacts will occur. If the Proposed Action is not implemented, there will be no socioeconomic impact to New Mexico. However, the region will forego economic, educational, and other socioeconomic benefits compared to doing the Proposed Action.

4.10.5.2 Reasonable Alternatives

One of the Reasonable Alternatives considered utilization of the alternate DOE de-conversion technology on the Proposed IIFP Site near Hobbs, New Mexico. This alternative technology is the same as that which will be used in the de-conversion process utilized at the DOE sites at Paducah, KY and Piketon, OH. With this DOE technology, UF₆ reacts with water and hydrogen to produce uranium oxide, which must be disposed of as waste in a licensed facility, and aqueous HF that has a lower market value than AHF. The socioeconomic impacts of this alternative are essentially the same as the Proposed Action.

Two of the enrichment companies have de-conversion facilities overseas and could choose to ship their DUF₆ from the U.S. to those facilities for de-conversion. Those companies that do have existing overseas facilities and technologies would be required to ship DUF₆ overseas long-distances and may have to return the waste oxides to United States for licensed disposal or may have to arrange with other countries for disposal. It is expected that socioeconomic impacts for this option of shipping the DUF₆ overseas may be similar to the Proposed Action.

The four enrichment companies could decide to build and operate their own de-conversion facilities in the U.S. If those companies were to build new facilities to de-convert “tails” material, it is expected that the socioeconomic impacts for this Reasonable Alternative are expected to be similar to the Proposed Action.

See Section 4.10.5.1 for the environmental impacts on socioeconomic should the enrichment companies utilize existing DOE de-conversion facilities.

4.11 Environmental Justice

This section examines whether there are disproportionately high minority or low-income populations residing within a 6.4 km (4 mi) radius of 130 km² (50 mi²) of the IIFP facility for which further examination of environmental impacts, is warranted to determine the potential for environmental justice concerns. The evaluation was performed using the most recent population and economic data available from the U.S. Census Bureau for that area, and was done in accordance with the procedures contained in NUREG-1748 (NRC, 2003a). This guidance was endorsed by the NRC's recently issued draft Policy Statement on the Treatment of Environmental Justice Matters in NRC Regulatory and Licensing Actions (FR, 2003). As discussed below, no minority or low-income populations were identified that will require further analysis of environmental justice concerns under the criteria established by the NRC.

4.11.1 Procedure and Evaluation Criteria

The determination of whether the potential for environmental justice concerns exists was made in accordance with the detailed procedures set forth in Appendix C to NUREG-1748 (NRC, 2003a). Census data from the 2000 census were obtained from the U.S. Census Bureau on the minority and low-income populations residing within a 6.4-km (4 mi) radius (130 km² or 50 mi² population area) from the center of the IIFP site. These data were obtained by census block group (CBG), and include (for minority populations) percentage totals within each census block group for both each individual minority population group (i.e., African-American, Hispanic, Native American) and for the aggregate minority population. A block group is a cluster of census blocks that are normally comprised of up to several hundred people. For low-income households (defined in NUREG-1748 as those households falling below the U.S. Census Bureau-specified poverty level), only the total percentage of such households within each CBG was obtained.

Once collected, the above-described minority and low-income population percentage data were then compared to their counterparts for their respective county and state. These comparisons were made pursuant to the "20%" and "50%" criteria contained in Appendix C to NUREG-1748, to determine (1) if any individual CBG contained a minority population group, aggregate minority population, or low-income household percentage that exceeded its county or state counterparts by more than 20 percentage points; and (2) if any CBG was comprised of more than 50% minorities (either by individual group or in the aggregate) or low-income households.

Based on its comparison of the relevant CBG data to their county and state counterparts, as discussed below, IIFP determined that further evaluation of potential environmental justice concerns is necessary, as CBG groups within the 6.4-km (4 mi) radius of the IIFP site contained minority or low-income populations exceeding the NUREG-1748 "20%" or "50%" criteria (NRC, 2003a).

4.11.2 Results of Census Block Group Data

The 130-km² (50-mi²) area around the Proposed IIFP Site includes parts of Lea County, New Mexico and Andrews/Gaines Counties, Texas. The minority population for each of the individual CBGs; as well as the total corresponding minority population for Lea, Andrews, and Gaines counties, the states of New Mexico and Texas and the 130 km² (50 mi²) area around the Proposed IIFP Site are enumerated in Table C-1, "Census Block Groups within 80 Kilometers (50 miles) of the Proposed IIFP Site" in the Appendix C, "Environmental Justice." The table also lists the percent make up of each minority around the 130-km² (50-mi²) area of the IIFP facility. Since the 130-km² (50-mi²) area around the IIFP plant covers both states, the comparisons were made to each state and the three counties (Lea County, New Mexico and Andrews/Gaines Counties, Texas).

Table 3-38, "Percentage of Minority and Low-Income Census Block Groups within 80 Kilometers (50) Miles of the Proposed IIFP Site," summarizes the data from Table C-1 in Appendix C. As shown in Table 3-38, the criteria resulted in 72 minority block groups out of 117 total block groups within 80 kilometers (50 miles) of the Proposed IIFP Site. Of these, 69 were identified using the total minority criterion, and an additional 3 were identified from 1 of the individual minority categories. Many of the minority block groups satisfied one or more individual minority group criteria in addition to the total minority criterion. The largest minority group is Hispanic or Latino, accounting for 42.1% of the total population in New Mexico and 32.0% in Texas.

In Lea County, New Mexico, the highest percentage of a minority population, at 28%, is also Hispanic or Latino. Table 3-38 shows that there are 28 individual CBGs within Lea County that are comprised of

more than 50% or 48% (20% greater than the Lea County average of 28%) of any minority population. With respect to the Hispanic or Latino population, Table C-1 in the Appendix shows the largest minority population in the 63 census blocks for Lea County is 73.9%. There are 8 block groups meeting environmental justice criteria for “Below Poverty Level” with the largest percentage at 57% in one CBG in Lea County. One block group meets the Environmental Justice criteria for “African American/Black” in Lea County at 39.8%. Additionally, 15 CBGs exceed the criteria for “Other Races” with the highest for Lea County at 53.1% for one block group. By far, the largest population center in Lea County is Hobbs which also has the largest minority population. See Figure 4-18, “Ethnic Breakdown for Hobbs, New Mexico.”

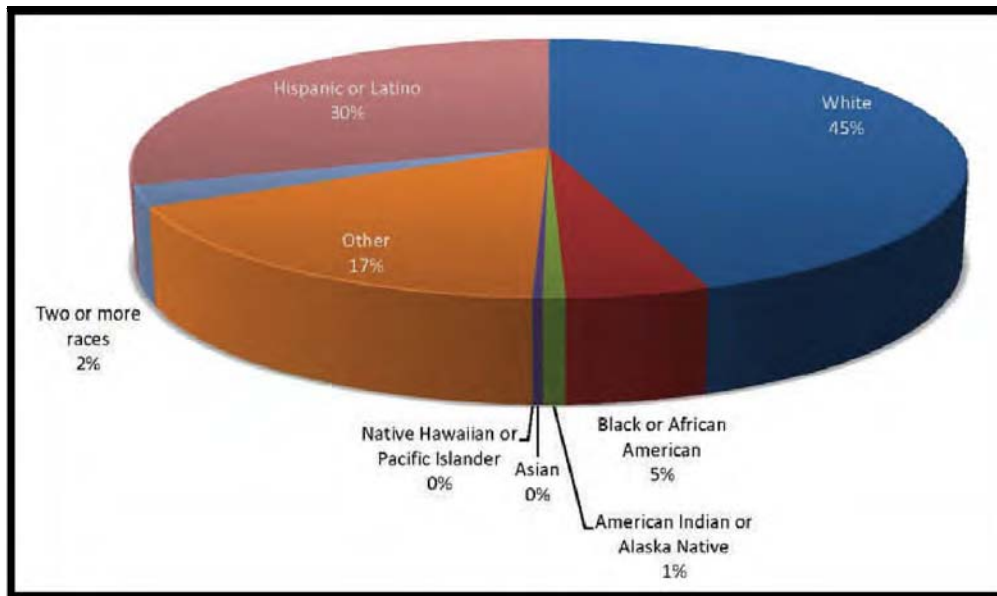

Source: EDCLC, 2009b

Figure 4- 18 Ethnic Breakdown for Hobbs, New Mexico

In Andrews County, Texas, Hispanic or Latino is the largest minority group as well at 40.0%. Table 3-31 shows there are 11 of the 15 total CBGs in Andrews County meeting the Environmental Justice criteria with the highest CBG at 70.6% for Hispanic or Latino population.

In Gaines County, Texas, Hispanic or Latino is the largest minority group as well at 35.8%. Table 3-38 shows there are 10 of the 13 total CBGs in Gaines County meeting the Environmental Justice criteria with the highest CBG at 69.6% for Hispanic or Latino population.

Based on this analysis of the above-described data, performed in accordance with the criteria, guidelines and procedures set forth in NUREG-1748, IIFP has concluded that disproportionately high minority or low-income populations exist that warrant further examination of environmental impacts upon such populations (NRC, 2003a).

4.11.3 NRC Review of NEF Environmental Justice

For the Environmental Impact Study conducted by the NRC for the National Enrichment Facility (NEF) in nearby Eunice, Texas, NRC conducted additional examination of environmental impacts upon the same populations. For each of the areas of technical analysis presented in that EIS (NRC, 2005), the review of

impacts to the human and natural environment was conducted to determine if any minority or low-income populations could be subject to disproportionately high and adverse impacts from the Proposed Action. That review included potential impacts from the construction and operation of the proposed NEF.

Through the scoping process, affected members of the African American/Black, Hispanic/Latino, and Indian tribe communities were contacted and asked to express their concerns about the project and to discuss how they perceived the construction and operation of the proposed NEF will affect them. The discussions elicited the following concerns:

- Potential loss of property values for houses owned by nearby residents.
- Potential groundwater conflicts.
- Potential radiological contamination (probably airborne given the locations involved) of persons near the proposed NEF.
- Potential transportation routes.

For each area of analysis, NRC reviewed the impacts to determine if any potential adverse impacts to the surrounding population will occur as a result of the proposed NEF construction and operations. If potential adverse impacts were identified, a determination was made as to whether minority or low-income populations will be disproportionately affected. Adverse impacts are defined as negative changes to the existing conditions in the physical environment (e.g., land, air, water, wildlife, vegetation, human health, etc.) or negative socioeconomic changes. Disproportionate impacts are defined as impacts that may affect minority or low-income populations.

Table 4-22 summarizes the potential impacts identified by NRC (NRC, 2005) to minority and low-income populations. Examination of the various environmental pathways by which low-income and minority populations could be disproportionately affected revealed no disproportionately high and adverse impacts from either construction or normal operations of the proposed NEF. In addition, no credible accident scenarios exist in which such impacts could take place. NRC staff concluded that no disproportionately high and adverse impacts will occur to minority and low-income populations living near the proposed NEF or along likely transportation routes into and out of the proposed NEF as a result of the Proposed Action. Thus, when considering the effect of the proposed NEF on environmental justice through direct environmental pathways, the impacts are SMALL.

4.11.4 Proposed Action

If the Proposed Action is undertaken, pre-licensing construction of the Proposed IIFP Facility will begin in early 2011. In late 2012, Phase 1 operation of the facility will begin. By 2016, Phase 2 operation of the Proposed IIFP Facility is expected to be fully operational.

4.11.4.1 Site Preparation and Construction

Site preparation and construction of the Proposed IIFP Facility may require a labor force of as many as 200 employees; construction employment is projected to vary depending on the site preparation and construction activities under way at any given time. Preparation of the IIFP facility site and construction

Table 4- 22 Potential Impacts of the Proposed Action on Minority and Low-Income Populations

Potential Impact ^a	Potentially Affected Minority population or Low-Income Community	Level of Impact
Land Use	Hispanic/Latino	SMALL
Historic and Cultural Resources	Indian Tribes	SMALL
Visual and Scenic Resources	Low-Income and Minority Populations near Proposed IIFP Site	SMALL
Air Quality	Hispanic/Latino	SMALL
Geology and Soils	Hispanic/Latino	SMALL
Water Resources	Hispanic/Latino	SMALL
Ecological Resources	None	SMALL
Socioeconomic and Community Resources: (Employment, Population, & Housing Values) Recreation Economic Structure	All Minorities, Low-Income Populations Low-Income and Minority Populations Low-Income and Minority Populations	SMALL to MODERATE (but generally beneficial and not disproportionate) SMALL SMALL to MODERATE (and beneficial)
Noise	Low-Income and Minority Populations near Proposed IIFP Site	SMALL
Transportation	Hispanic/Latino, African American/Black, Low Income	MODERATE (but not disproportionate)
Human Health Radiological Nonradiological	Low-Income and Minority Populations near Proposed Transport Routes and Downwind of the Proposed IIFP Site	SMALL

Source: NRC, 2005

of the IIFP facility is projected to take approximately 20-24 months, beginning in 2011 and ending in 2012. During the site preparation and construction phase of the project, environmental impacts (discussed in detail in the sections noted in parentheses) may include the following:

- Increased truck and car traffic associated with construction materials and labor (see Section 4.2, “Transportation Impacts”).
- Air quality impacts from both construction traffic and operation of construction equipment (see Section 4.6.1, “Air Quality Impacts from Construction”).
- Increased noise associated with the operation of construction machinery (see Section 4.7.1, “Predicted Noise Impacts”).
- Positive socioeconomic results from the capital infusion into the economy and increased employment and higher wages for the region.

The environmental impacts associated with site preparation and construction of the Proposed IIFP Plant are generally estimated to be SMALL, and generally will be mitigated. The only MODERATE impact involves modified wildlife travel corridors during construction and increased traffic congestion on NM 483 for the 1.5-mile distance between Arkansas Junction and the site access road, especially during shift-change hours. These impacts will mainly affect personnel working the surrounding industries identified in Section 3.1.2, “Description of Off-site Areas,” and passing motorists since there are no residents within a

4.0 mile radius of the Proposed IIFP Facility. The Proposed IIFP Facility is located in NM Census Tract 000700. (See Figure 4-19, “Lea County Population, Census 2000 by Census Tract.”). Census Tract 0700 residents since there are no residents within that 4-mile radius of the site. Thus, it is not expected that construction of the facility will give rise to environmental justice concerns.

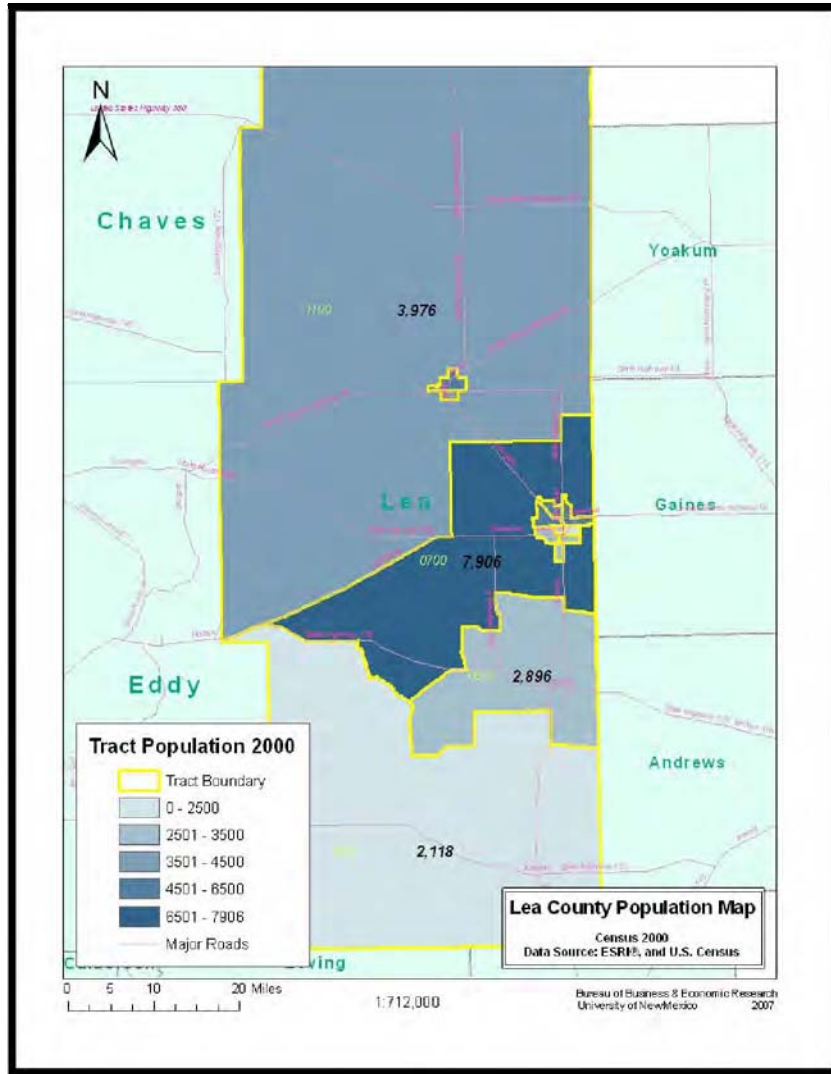

Figure 4- 19 Lea County Population, Census 2000 by Census Tract

4.11.4.2 Operation

Operation of the Proposed IIFP Facility will be expected to begin operation of the Phase 1 plant in late 2012 and the Phase 2 plant in mid-2016. The facility is projected to employ as many as 138 FTEs engaged in Phase 1 operations and 160 FTEs engaged in Phase 2 operations. During the operation phase of the project, potential environmental impacts (discussed in detail in the sections in parentheses) may include the following:

- Increased truck and car traffic associated with transportation of materials and product, as well as employees, to and from the Proposed IIFP Facility (see Section 4.2, “Transportation Impacts”).

- Air emissions associated with both vehicle exhaust and operation of the facility (see Section 4.6.2, “Air Quality Impacts from Operations”).
- Trace radiological releases (see Section 4.12, “Waste Management Impacts”).
- Increased noise associated with the operation of the facility (see Section 4.7, “Noise Impacts”).

As was the case for construction, the environmental impacts associated with the operations phase of the Proposed Action will be most likely to affect employees of the nearby industries and passing motorists since there are no residents within 6.4 km (4 mi) of the Proposed IIFP Facility. As stated in 4.11.4.1, the site is located in NM Census Tract 000700 with only one of six CBGs having minority residents comprising 54.2% of its population and low-income residents ranging from 1.7% for CBG 2 to 19% for CBG 5 of its population. Environmental impacts of facility operations are projected to be SMALL, and no adverse health impacts are expected since there are no residents within a radius of 6.4 km (4 mi) of the proposed facility.

As discussed in Section 4.12.2, “Radiological Impacts,” the radiological doses to the nearest residents resulting from operations of the Proposed IIFP Facility are projected to be well below the EPA 10 millirem (mrem; .1 milliSieverts [mSv]) per year standard (20 CFR 190) and the NRC total effective dose equivalent (TEDE) 100 mrem (1 mSv) per year limit (10 CFR 20, Standards for Protection Against Radiation). Therefore, operations of the Proposed IIFP Facility are not expected to result in disproportionately high or adverse impacts on minority or low-income populations.

Because the greatest impact is expected to occur immediately next to the plant (no ethnicities or personnel with low income levels within 6.4 km (4 mi)), the operations phase of the Proposed Action is not expected to result in disproportionately high or adverse impacts on low-income or minority residents; thus, the operation of the facility is not expected to give rise to environmental justice concerns.

4.11.4.3 Decommissioning

Decommissioning of the Proposed IIFP Facility is projected to begin in 2049; decommissioning is projected to consist of removal of equipment from the facility, but the building, parking area, and access roads are projected to remain in place. Decommissioning will be expected to employ 40 FTEs and result in a reduction in environmental impacts relative to construction and operation of the facility, but slightly higher than baseline. Again, impacts are expected to be concentrated in the vicinity of the Proposed IIFP Facility; thus, NM Census Tract 000700, CBG 2, will experience a higher share of any environmental impacts than will CBGs located farther from the facility. Because the CBG in which the facility is located has no minority and low-income residents within a 4-mile radius (50 mi²) of the plant, decommissioning of the facility is not expected to result in disproportionately high or adverse impacts on minority or low-income populations. Thus, decommissioning of the IIFP facility is not expected to pose environmental justice concerns.

4.11.4.4 Cumulative Impacts

All phases of the Proposed IIFP Facility have the potential to generate environmental impacts on the areas surrounding the facility, including a CBG with relatively high proportion of minority residents. However, the results of the analysis indicate that the cumulative environmental impacts experienced by residents from the construction, operation, and decommissioning phases of the Proposed Action will be SMALL, and any adverse health impacts will be SMALL. The only MODERATE impacts estimated are increased traffic congestion on NM 483 between the proposed new dedicated IIFP facility entrance and Arkansas Junction, especially during shift-change hours, and these impacts will mainly affect the neighboring industries or passing motorists since no residents are located within 6.4 km (4 mi) of the proposed facility.

Thus environmental impacts from the pre-licensing and general construction, operation, and decommissioning of the IFFP facility are not expected to result in disproportionately high or adverse impacts on minority or low-income populations.

In addition to the potential environmental impacts associated with pre-licensing and general construction, operation, and decommissioning of the Proposed IFFP Facility, there are projected to be substantial positive economic impacts for the area, including increased employment and income. During construction, it is projected that up to 200 employees will be needed; during facility start-up, up to 138 employees will be needed; during regular Phase 2 operations, approximately 160 employees will be required; and during decommissioning, approximately 40 employees will be required. The majority of the workers, especially for operations, are expected to be hired from within the region. A wide range of skills and education levels will be needed; thus, there will be employment opportunities available to the residents of all CBGs surrounding the facility, including those with relatively high percentages of minority and low-income residents.

4.11.5 Comparative Environmental Justice Impact of Alternative Actions

ER Chapter 2 provides a discussion of possible alternatives to the construction and operation of the IFFP facility, including an alternative of "No-Action," i.e., not building the IFFP facility. Additionally, IFFP considered reasonable alternatives using alternative technologies for de-conversion services and production of fluorine products.

4.11.5.1 No-Action Alternative

The DOE de-conversion facilities are sized and built to dispose of the DOE DUF₆ inventory. The de-conversion and disposal is expected to take 20 to 25 years. If DOE were to process privately owned DUF₆, de-conversion would likely have to await completion of the DOE mission or DOE would have to add additional capacity to their plants. A 20 to 25 year delay in processing the DUF₆ would force private enrichment facilities to store tails on site or to build or use their own de-conversion facilities.

The No-Action Alternative of long-term storage of DUF₆ may present potential unnecessary risk to the public. If DOE were to expand its facilities for additional capacity, additional environmental justice impacts will be incurred at Paducah, KY and/or Piketon, OH. If the commercial enrichment facilities had to store tails indefinitely, no additional environmental justice impacts will occur. If the Proposed Action is not implemented, there will be no environmental justice impact to New Mexico.

4.11.5.2 Reasonable Alternatives

One of the Reasonable Alternatives considered utilization of the alternate DOE de-conversion technology on the Proposed IFFP Site near Hobbs, New Mexico. This alternative technology is the same as that which will be used in the de-conversion process utilized at the DOE sites at Paducah, KY and Piketon, OH. With this DOE technology, UF₆ reacts with water and hydrogen to produce uranium oxide, which must be disposed of as waste in a licensed facility, and aqueous HF that has a lower market value than AHF. The environmental justice impacts of this alternative are essentially the same as the Proposed Action.

Two of the enrichment companies have de-conversion facilities overseas and could choose to ship their DUF₆ from the U.S. to those facilities for de-conversion. Those companies that do have existing overseas facilities and technologies would be required to ship DUF₆ overseas long-distances and may have to return the waste oxides to United States for licensed disposal or may have to arrange with other countries

for disposal. It is expected that environmental justice impacts for this option of shipping the DUF_6 overseas may be similar to the Proposed Action.

The four enrichment companies could decide to build and operate their own de-conversion facilities in the U.S. If those companies were to build new facilities to de-convert “tails” material, it is expected that the environmental justice impacts for this Reasonable Alternative are expected to be similar to the Proposed Action.

See Section 4.11.5.1 for the environmental impacts on environmental justice should the enrichment companies utilize existing DOE de-conversion facilities.

4.12 Public and Occupational Health Impacts

4.12.1 Nonradiological Impacts

Sources of nonradiological exposure to the public and to facility workers are characterized below. Nonradiological effluents have been evaluated and do not exceed criteria in 40 CFR 50, 59, 60, 61, 122, 129, or 141 (CFR, 2009h; CFR, 2009i; CFR 2009j; CFR, 2009ii; CFR, 2009p; CFR, 2009s; CFR, 2009t). Radionuclides, and hydrogen fluoride, are governed as a National Emission Standards Hazardous Air Pollutants (NESHAP) (EPA, 2004b). Details of radiological gaseous and liquid effluent impacts and controls are listed in ER Section 4.12.2, “Radiological Impacts.”

The initial list of hazards, based on the current plant conceptual design information, is subsequently categorized and documented in the License Application Integrated Safety Analysis. The primary chemical hazard is HF. Exposure pathways can occur directly from anhydrous HF or from a byproduct reaction from another source (DUF_6 , DUF_4 , SiF_4 , or BF_3). UF_4 is essentially stable and will only generate HF at this facility as a byproduct when reacted with SiO_2 and heat. DUF_6 , SiF_4 and BF_3 however, generate HF off-gas when reacted with water or water vapor. A release of these chemical compounds from containment will result in the formation of HF from the reaction with water vapor in the air. HF is a clear, colorless, corrosive fuming liquid with a very acrid odor. In high concentrations a release can form dense white vapor clouds. Both liquid and vapor can cause severe burns to all parts of the body. Exposure to skin, eyes and inhalation or ingestion can cause severe health consequences up to and including death. Accident pathways involving the release of HF are of significant concern to the design of this facility and will be rigorously evaluated during the safety analysis and will be documented in the licenses supporting documents.

The primary radiological hazard is UF_6 due to its vigorous reaction with moisture in the air to form HF gas and finely divided UO_2F_2 . UO_2F_2 becomes a significant inhalation problem due to its property to readily disperse and its small particle size. The chemical hazard from HF and the heavy metal toxicity of UO_2F_2 far outweigh the radiological dose hazard.

Other hazards identified to date are the more common industrial health and safety hazards that one will encounter at a manufacturing plant. These hazards will be evaluated further in more detailed safety analyses.

4.12.1.1 Routine Gaseous Effluent

Routine gaseous effluents from the plant are listed in Table 4-23, “Estimated Annual Non-Radiological Gaseous Effluent.” Radiological effluent estimates are shown in Table 4-24, “Estimated and Bounding Radiological Releases from the Stacks.”

Table 4- 23 Estimated Annual Non-Radiological Gaseous Effluent.

Emission	Estimated Releases		
	DUF ₆ to DUF ₄ Stack	SiF ₄ & BF ₃ Production Stack	DUF ₆ to DU Oxide Stack
SiF ₄	N/A	0.08 kg/yr (0.18 lb/yr)	N/A
BF ₃	N/A	0.40 kg/yr (0.88 lb/yr)	N/A
HF	1.19 kg/yr (2.63 lb/yr)	5.17 kg/yr (11.39 lb/yr)	2.78 kg/yr (6.13 lb/yr)

Table 4- 24 Estimated and Bounding Radiological Releases from the Stacks

Radionuclide	DUF ₆ to DUF ₄ Stack		SiF ₄ & BF ₃ Production Stack		DUF ₆ to DU Oxide Stack	
	kBq/yr	Ci/yr	kBq/yr	Ci/yr	kBq/yr	Ci/yr
Estimated Releases						
²³⁴ U	2.15E+02	5.80E-06	2.09E+02	5.66E-06	4.19E+02	1.13E-05
²³⁵ U	2.12E+01	5.73E-07	2.07E+01	5.59E-07	4.15E+01	1.12E-06
²³⁸ U	1.65E+03	4.45E-05	1.61E+03	4.34E-05	3.22E+03	8.70E-05
Total	1.88E+03	5.08E-05	1.84E+03	4.96E-05	3.68E+03	9.94E-05
Bounding Releases						
²³⁴ U	4.29E+02	1.16E-05	4.19E+02	1.13E-05	8.39E+02	2.27E-05
²³⁵ U	4.24E+01	1.15E-06	4.14E+01	1.12E-06	8.29E+01	2.24E-06
²³⁸ U	3.29E+03	8.89E-05	3.21E+03	8.68E-05	6.43E+03	1.74E-04
Total	3.76E+03	1.02E-04	3.67E+03	9.93E-05	7.36E+03	1.99E-04

Routine gaseous effluents from the plant are listed in Table 4-23, “Estimated Annual Non-Radiological Gaseous Effluent” and Table 4-24, “Estimated and Bounding Radiological Releases from the Stacks.” Worker exposure to in-plant gaseous effluents will be minimal. No exposures exceeding 29 CFR 1910, Subpart Z are anticipated (CFR, 2009g). Laboratory and maintenance operations activities involving hazardous gaseous or respirable effluents will be conducted with ventilation control (i.e., fume hoods, local exhaust or similar) and/or with the use of respiratory protection as required. All regulated gaseous effluents will be below regulatory limits as specified by the New Mexico Air Quality Bureau.

4.12.1.2 Routine Liquid Effluent

The facility does not directly discharge any industrial effluents to natural surface waters or grounds on site, and there is no plant tie in to a Publicly Owned-Treatment Works (POTW). All effluents are contained on the IIFP site via collection tanks. No public impact is expected from routine liquid effluent discharge. Impacts from routine liquid effluents are SMALL.

No exposures exceeding 29 CFR 1910 (CFR, 2009g), Subpart Z are anticipated. Additionally, handling of all chemicals and wastes will be conducted in accordance with the site Environment, Health, and Safety Program which will conform to 29 CFR 1910 (CFR, 2009g) and specify the use of appropriate engineered controls, as well as personnel protective equipment, to minimize potential chemical exposures.

4.12.2 Radiological Impacts

Sources of radiation exposure incurred by the public generally fall into one of two major groupings; naturally-occurring radioactivity and man-made radioactivity. Naturally-occurring radioactivity includes primordial radionuclides (nuclides that existed or were created during the formation of the earth and have a sufficiently long half-life to be detected today) and their progeny nuclides, and nuclides that are continually produced by natural processes other than the decay of the primordial nuclides. These nuclides are ubiquitous in nature, and are responsible for a large fraction of radiation exposure referred to as background exposure. Uranium (U), the material used in the IIFP operations, is included in this group. Man-made radioactivity, which includes radioactivity generated by human activities (e.g., fallout from weapons testing, medical treatments, and x-rays), also contributes to background radiation exposure. The combined relative concentrations of naturally-occurring radioactivity and man-made radioactivity in the environment vary extensively around the world, with variations seen between areas in close proximity. The concentration of radionuclides and radiation levels in an area are influenced by such factors as geology, precipitation, runoff, topsoil disturbances, solar activity, barometric pressure, and a host of other variables. The annual total effective dose equivalent from background radiation in the United States varies from 2.0 to 3.0 mSv (200 to 300 mrem) depending on the geographic region or locale and the prevalence of radon and its daughters.

Workers at the IIFP plant are subject to higher potential exposures than members of the public because they are involved directly with handling uranium cylinders, uranium processes, and decontamination and maintenance of equipment. During routine operations, workers at the plant potentially may be exposed to radiation from uranium via inhalation of airborne particles and direct exposure to equipment and components containing uranic materials. The radiation protection program at the IIFP facility requires routine radiation surveys and air sampling to assure that worker exposures are maintained as low as reasonably achievable (ALARA). In addition, exposure-monitoring techniques at the plant include use of personal dosimeters by workers, personnel breathing zone air sampling, and annual whole-body counting.

In addition to the radiological hazards associated with uranium, workers may be potentially exposed to the chemical hazards associated with uranium. The material, UF_6 , is hygroscopic (moisture absorbing) and, in contact with water, will chemically breakdown into UO_2F_2 and HF. When released to the atmosphere, gaseous UF_6 combines with humidity to form a cloud of particulate UO_2F_2 and HF fumes. The reaction is very fast and is dependent on the availability of water vapor. Consequently, an inhalation to UF_6 is typically an internal exposure to HF and UO_2F_2 . In addition to the radiation dose, a worker will be subjected to two other primary toxic effects: (1) the uranium in the uranyl complex acts as a heavy metal poison that can affect the kidneys and (2) the HF can cause acid burns to the skin and lungs if concentrated. Because of low specific activity values, the radiotoxicity of UF_6 and its products are smaller than their chemical toxicity.

Implementation of a radiation protection program and a health and safety program will protect workers at the IIFP facility. The Radiation Protection Program will comply with all applicable NRC requirements established in 10 CFR 20 (CFR, 2009a), Subpart B. Similarly, the Health and Safety Program at the IIFP plant will comply with all applicable OSHA requirements established in 29 CFR 1910 (CFR, 2009g).

The general public and the environment may be impacted by radiation and radioactive material from the IIFP facility in two primary ways. Potential radiological impacts may occur from (1) gaseous and liquid effluent discharges associated with controlled releases from the uranium process lines during routine operations and from decontamination and maintenance of equipment, and (2) direct radiation exposure associated with transportation and storage of depleted UF_6 cylinders and wastes.

The potential radiological impacts to the public from operations at the IIFP plant are those associated with chronic exposure to low levels of radiation and not the immediate health effects associated with acute radiation exposure. The major sources of potential radiation exposure are the effluent from the plant scrubber systems for the DUF₄ and FEP processes and the dust collector scrubber system. It is estimated that the total amount of uranium released to the environment via air effluent discharges from the IIFP facility will be less than 1.5 kg (3.3 lb) per year.

Due to the anticipated low volume of contaminated liquid waste and the effectiveness of treatment processes, no liquid effluent discharges are expected. Therefore, there will be no significant radiological impact to the public or the environment from air emission or liquid effluent discharges. In addition, the radiological impacts associated with direct radiation from indoor operations are not expected to be a significant contributor because the low-energy gamma-rays associated with the uranium will be absorbed almost completely by the process lines, equipment, cylinders, and building structures at the IIFP. See Table 4-24, "Estimated and Bounding Radiological Releases from the Stacks." The radiological impacts from air emissions, liquid effluent discharges and direct radiation from indoor operations are SMALL.

Discharges of gaseous effluent from the scrubbing systems from the DUF₄ and FEP processes, and the dust collector scrubbers are from the middle of the 40-acre Site. Airborne concentrations of uranium present in gaseous effluent continually decrease with distance from the release point. Therefore, the greatest off-site radiological impacts are expected at or near the site boundaries. The nearest known resident has been identified at a distance of approximately 8.5 km (5.3 mi) northeast of the site. The nearest businesses include Colorado Energy Hobbs Station at a distance of 2 km (1.1 mi) NE of the site, Xcel Energy Cunningham at a distance of 2 km (1.3 mi) WSW of the site, and Xcel Energy Maddox 4 km (2.2 mi) E of the site. Xcel Energy Cunningham Station on the west sector. A natural gas processing station, DCP Midstream, is located 6 km (3.6 mi) southeast of the IIFP buildings. No other important receptor locations such as schools, have been identified within an 8-km (5-mi) radius of the IIFP site (refer to ER Section 3.10). With respect to ingestion pathways, there is little in the way of food crops grown within an 8-km (5-mi) radius due to semi-arid nature and minimal development of the local area for agriculture. Cattle grazing across the open range has been observed in the vicinity of the site. The radiological impacts on members of the public and the environment at these potential receptor locations are expected to be only small fractions of the radiological impacts that have been estimated for the site boundary locations because of the low concentrations in gaseous effluent and the high degree of dispersion that takes place as the gaseous effluent is transported.

The potential off-site radiological impacts to members of the general public from routine operations at the IIFP facility were assessed through calculations designed to estimate the annual committed effective dose equivalent (CEDE) and annual committed dose equivalent to organs from effluent releases. The calculations also assessed impacts from direct radiation from stored uranium in depleted UF₆ feed cylinders and empty cylinders. The term "dose equivalent" as described throughout this section refers to a 50-year committed dose equivalent. The addition of the effluent related doses and direct dose equivalent from fixed sources provides an estimate of the total effective dose equivalent (TEDE) associated with plant's operations. The calculated annual dose equivalents were then compared to regulatory (NRC and EPA) radiation exposure standards as a way of illustrating the magnitude of potential impacts.

4.12.2.1 Pathway Assessment

Routine Gaseous Effluent

Most of the airborne uranium is removed through filtration prior to the discharge of gaseous effluent to the atmosphere. However, the release of uranium in extremely low concentration is expected and raises

the potential for radiological impacts to the general public and the environment. The total annual discharge of uranium in routine gaseous effluent from operations of the Honeywell plant in Metropolis, IL is reported to be less than 30 g (1.1 oz) (NRC, 1994a). The annual discharge of uranium in routine gaseous effluent discharged from the IIFP plant is estimated to be less than 550 g (20 ounces). As a conservative assumption for assessment of potential radiological impacts to the general public, the uranium source term used in the assessment of radiological impacts for routine gaseous effluent releases from the IIFP facility was taken as 14.8 MBq (400 micro Ci) per year.

There are four primary exposure pathways associated with plant effluent: inhalation; immersion in a passing effluent plume; direct radiation due to deposited radioactivity on the ground surface (ground plane exposure); and ingestion of contaminated food products. Of these four exposure pathways, inhalation exposures are expected to be the predominant pathways at site boundary locations and also at off-site locations that are relatively close to the site boundary. The reason for this is that the discharge point for gaseous effluent, roof-top stacks result in ground level effluent plumes. For ground level plume, the airborne concentration(s) within the plume decreases with the distance from the discharge point. Consequently, for gaseous effluent from the IIFP facility, the highest off-site airborne concentrations (and, hence, the greatest radiological impacts) are expected at locations close to the site boundary. Beyond those locations, the concentrations of airborne radioactive material decreases continually as it is transported because of dispersion and depletion processes. Although radiological impacts via the ingestion exposure pathways come into play for distances beyond the site boundary, the concentrations of radioactive material will have been greatly reduced by the time effluent plumes reach those locations.

Under routine operations, the potential that radioactivity from the Cylinder Storage Pads may impact the public is low because the cylinders are surveyed for external contamination before they are placed on the staging area. Therefore, rainfall runoff from the pad is not expected to be a significant exposure pathway. Runoff water from the Cylinder Storage Pads is directed from the Staging Pads to an on-site retention basin for evaporation of the collected water. Periodic sampling of the soil from the basins is performed to identify accumulation or buildup of any residual cylinder surface contamination washed off by rainwater to the basins (see ER Section 6.1, "Radiological Monitoring"). No liquids from the retention basins are discharged directly off site. In addition, direct radiation from the Cylinder Storage Pads is monitored on a quarterly basis using thermoluminescent dosimeters (TLDs).

Direct Radiation

Temporary storage of full depleted feed cylinders and empty depleted cylinders at the IIFP facility may have an impact due to direct and scatter (sky shine) radiation to the site boundary, and to lesser extents, off-site locations. Typically, approximately 50 full depleted tails cylinders and 30 empty depleted cylinders will generally be stored at the IIFP site. The empty cylinders will be shipped back to the enrichment facility for their reuse.

4.12.2.2 Public and Occupational Exposure Impacts

The key receptor locations (critical populations) for determining dose impacts included the resident nearest to the IIFP facility and the maximally exposed individual (MEI) (at the northwest boundary). The MEI is a hypothetical person living at the point of highest projected total uranium concentrations near the site boundary. The impact due to gaseous effluents was evaluated for the dose from inhalation; immersion in a passing effluent plume; direct radiation due to deposited radioactivity on the ground surface (ground plane exposure); and ingestion of contaminated food products. No radiological contamination of drinking water is anticipated or considered in the analysis. The analysis included dose equivalent assessments for four age groups (i.e., adults, teens, children, and infants) for these pathways.

Doses were calculated using GENII (version 2.08), which was developed for EPA to provide a set of programs for calculating radiation dose and risk from radionuclides released to the environment.

For both the inhalation and ingestion exposure pathways, the exposure-to-dose conversion factors (DCF) were taken from Federal Guidance Report 11 (FGR-11) (EPA, 1988) and were applied for both the committed organ equivalent dose and the committed effective equivalent dose. No assumption on the chemical form of the uranic material deposited in the environment is made due to the extended time that effluents will persist in the open environment and the unknown change in chemical form that might take place over time. As a consequence, the most restrictive clearance class for inhalation and fractional uptake condition for ingestion is assumed (for conservatism) in the selection of dose factors from Federal Guidance Report 11 (EPA, 1988).

For direct dose from material deposited on the ground plane or from the passing cloud, the DCF from Federal Guidance Report No. 12 (EPA, 1993a) has been applied. For ground plane exposures, it is assumed that the material deposited from the passing cloud remains on the ground surface as an infinite source plane (i.e., no mixing with any soil depth). This provides the most conservative assumption for direct ground plane exposure. The dose from ground plane deposition was evaluated after 30 years (end of expected license period) to account for the maximum buildup of released activity, including the ingrowth of radionuclide progeny from the primary uranium isotopes that make up the expected release from the plant. This provides the upper bound on any single year of projected plant impacts. For external exposures from plume immersion and ground plane exposure, the skin is added to those organs that were evaluated for internal exposures (inhalation and ingestion).

The ingestion pathway models for locally grown or raised food products were taken from NRC Regulatory Guide 1.109 (NRC, 1977c). The models projected isotopic concentrations in vegetation, milk and meat products based on the annual quantity of uranium material assumed to be released to the air and the atmospheric dispersion and deposition factors at key receptor locations of interest. These food product concentrations were then used to determine the ingestion committed effective dose equivalent and organ doses by multiplying the individual organ and effective dose conversion factors by the food product concentrations and the annual individual usage factors from the NRC Regulatory Guide 1.109 (NRC, 1977c).

The dose factors in the FGR-11 (EPA, 1988) are derived for adults. In order to estimate the impact to other age groups, the doses calculated to adults were adjusted for difference in food consumption or inhalation rates as taken from NRC Regulatory Guide 1.109 (NRC, 1977c) and then multiplied by the relative age dependent dose factor for the effective dose equivalent as found for the different ages in the International Commission of Radiological Protection (ICRP) Report No. 72 (ICRP, 1995). With respect to the DCF's for adults, the relative ingestion dose commitment multiplier by age group for the four isotopes of uranium of concern averaged 1.0 (adults), 1.5 (teens), 1.8 (children) and 7.5 (infants). For the inhalation pathway, these relative dose commitment multipliers are 1.0 (adult), 1.2 (teens), 2.02 (children) and 4.25 (infants).

The atmospheric dispersion factors used in the radiological impacts assessment were calculated as described in ER Section 4.6, "Air Quality Impacts." The meteorological data was taken from the National Weather Service station for Midland - Odessa, Texas as documented in the STAR file accompanying the GENII software package.

Dose equivalents for the MEI and the nearest resident due to gaseous effluents were calculated by pathway for the total body in adults, teens, children, and infants, and are presented in Tables 4-25 and Table 4-26, respectively. The CEDE for the adult MEI from the Proposed IIFP Facility emissions was

calculated to be 8.40E-06 mSv (8.40E-04 mrem) per year. For the adult full-time resident nearest to the facility, the CEDE from the IIFP facility was calculated to be 6.40E-09 Sv (6.40E-07 rem) per year.

Table 4- 25 Annual and Committed Dose Equivalents for Exposures to the MEI from Gaseous Effluents

Source	Units	Adult EDE	Teen EDE	Child EDE	Infant EDE
Cloud Immersion	Sv	9.78E-16	9.78E-16	9.78E-16	9.78E-16
	rem	9.78E-14	9.78E-14	9.78E-14	9.78E-14
Inhalation	Sv	8.14E-08	9.77E-08	1.65E-07	3.46E-07
	rem	8.14E-06	9.77E-06	1.65E-05	3.46E-05
Ingestion	Sv	2.21E-09	3.32E-09	3.98E-09	1.66E-08
	rem	2.21E-07	3.32E-07	3.98E-07	1.66E-06
Ground Plane Exposure	Sv	3.53E-10	3.53E-10	3.53E-10	3.53E-10
	rem	3.53E-08	3.53E-08	3.53E-08	3.53E-08
Sum Total	Sv	8.40E-08	1.01E-07	1.69E-07	3.63E-07
	rem	8.40E-06	1.01E-05	1.69E-05	3.63E-05

Table 4- 26 Annual and Committed Dose Equivalents for Exposures to the Nearest Resident from Gaseous Effluents

Source	Units	Adult EDE	Teen EDE	Child EDE	Infant EDE
Cloud Immersion	Sv	7.46E-17	7.46E-17	7.46E-17	7.46E-17
	rem	7.46E-15	7.46E-15	7.46E-15	7.46E-15
Inhalation	Sv	6.20E-09	7.45E-09	1.25E-08	2.64E-08
	rem	6.20E-07	7.45E-07	1.25E-06	2.64E-06
Ingestion	Sv	1.68E-10	2.53E-10	3.03E-10	1.26E-09
	rem	1.68E-08	2.53E-08	3.03E-08	1.26E-07
Ground Plane Exposure	Sv	2.69E-11	2.69E-11	2.69E-11	2.69E-11
	rem	2.69E-09	2.69E-09	2.69E-09	2.69E-09
Sum Total	Sv	6.40E-09	7.73E-09	1.29E-08	2.77E-08
	rem	6.40E-07	7.73E-07	1.29E-06	2.77E-06

The direct dose equivalent from the 30 years life expectation of the site was calculated with the MCNP4C2 computer code (ORNL, 2000a). Included in the total was the expected number of full and empty UF₆ cylinders. The empty cylinders were included because they contain decaying residual material and produce a higher dose equivalent than full DUF₆ cylinders due to the absence of self-shielding and the presence of uranium progeny.

The photon source intensity and spectrum were calculated using the MicroShield computer code (ORNL, 2000b). In addition to the photon source term, there is a two-component neutron source term. The first component of the neutron source term is due to spontaneous fission by uranium. The second component is due to neutron emission by fluorine after alpha particle capture. Each of these components was also included in the direct dose determination.

The annual offsite dose equivalent was calculated at the IIFP fence line assuming 2,000 hours per year occupancy. Implicit in the use of 2,000 hours is the assumption that the dose equivalent is to a non-resident (i.e., a worker at an unrelated business). The annual dose equivalents for the actual nearest worksite and at the nearest residence were also calculated.

The highest dose equivalent at the IIFP fence line is 0.21 mSv/yr (20.80 mrem/yr) assuming 2,000 hours per year occupancy. The dose equivalent at the nearest actual worksite to the northeast, 1.82 km (1.13 mi) is 1.40E-03 mSv/yr (1.40E-01 mrem/yr). The dose equivalent at the nearest actual residence northeast 8.5 km (5.3mi) is 3.00E-04 mSv/yr (3.00E-02 mrem/yr). In the latter case, full-time occupancy (i.e., 8,760 hours per year) is assumed.

Direct dose rates and deep dose equivalent (DDE) for the MEI and the nearest resident were calculated and are presented in Table 4-27. The dose rates are reported for both the empty and full cylinder storage areas as the closest boundary location is different for each staging pad. In the case of the nearest industrial site and nearest resident, the dose rates reported are for the total dose rates due to both staging areas.

The CEDE and the DDE are totaled to determine the TEDE for the MEI. The TEDE was determined to be 0.21 mSv/yr (20.80 mrem/yr). Therefore, radiological impacts to off-site receptors from routine combined effluent releases and direct radiation are anticipated to be SMALL. Doses for public receptors at other sites of interest (e.g., schools and hospitals) would be lower than the MEI because the airborne concentrations of uranium are lower at these more distant locations.

Table 4- 27 Estimated Dose Rates for Site Boundary Locations, MEI, and Nearest Resident

Location	Dose Rate, mSv per hour (mrem per hour)	
	Empty Cylinder Storage Area	Full Cylinder Storage Area
North Boundary	1.08E-05 (1.08E-03)	2.96E-04
South Boundary	3.63E-05 (3.63E-03)	5.75E-03
East Boundary	1.04E-04 (1.04E-02)	6.05E-05
West Boundary (MEI)	3.16E-05 (3.16E-03)	1.04E-02
Nearest Industrial Site	7.05E-07 (7.05E-05)	
Nearest Resident	3.22E-08 (3.22E-06)	
Nearest On-Site Work Location	1.31E-03 (1.31E-01)	4.56E-05 (4.56E-03)

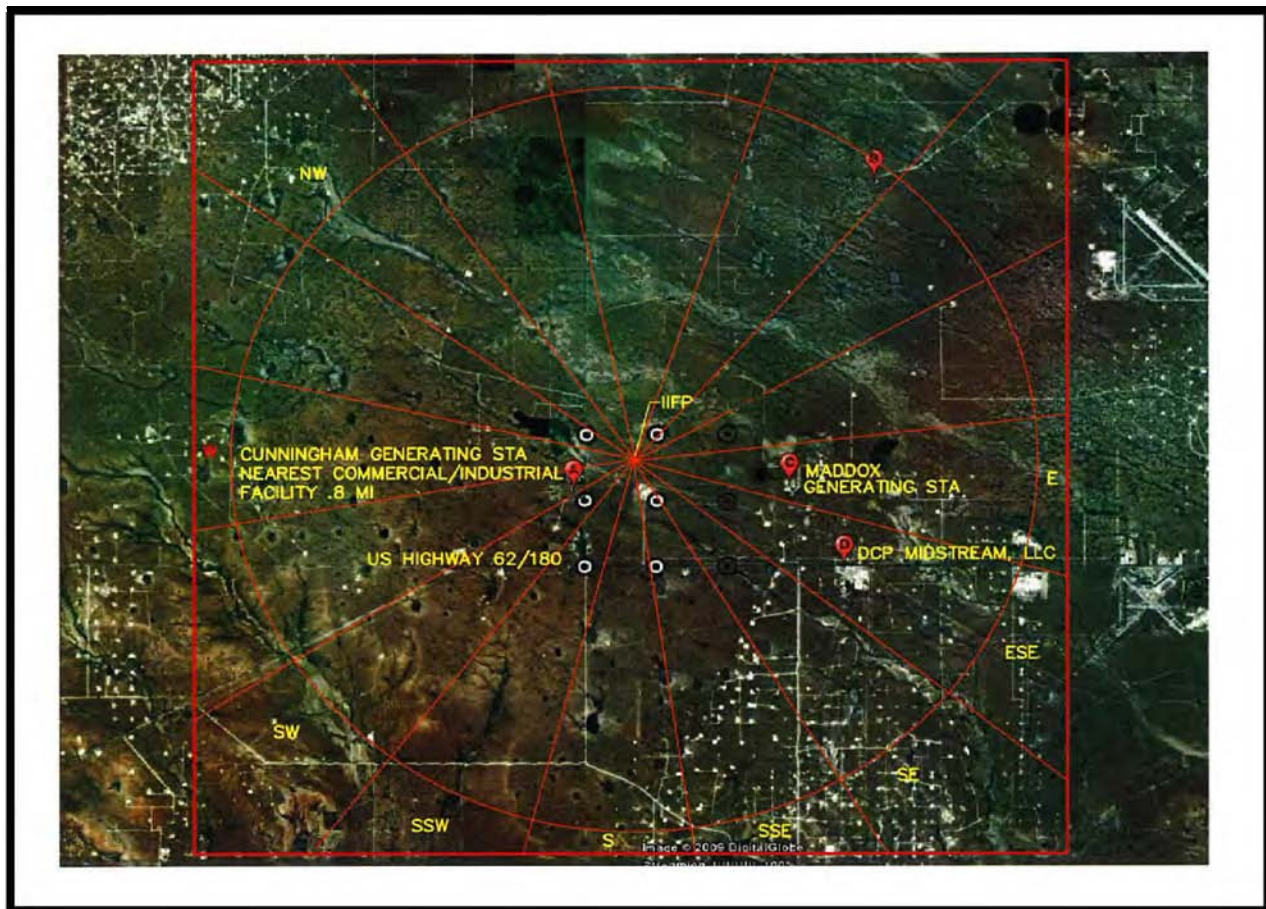

Figure 4- 20 Sector Compass Rose Diagram around the IIFP Site

Population Dose Equivalents

The local area population distribution was derived from U.S. Census Bureau 2000 data for counties in New Mexico and Texas (DOC, 2000a; DOC, 2000b; DOC, 2000c; DOC, 2000d) that fall all or in part of an 80-km (50-mi) radius of the IIFP site. A standard 16-sector compass rose was centered on the IIFP site and divided into annular rings at selected distances. See Figure 4-20 above. Population counts from census data that located significant population groups for towns or cities within the 80-km (50-mi) area were then distributed into those sectors that covered the groupings. After accounting for these significant population locations, the balance of the population for the different counties persons per square kilometer (square mile) was distributed by equal area allocation based on the land area in the sector. For the first 8 km (5 mi), site area observations provided information on the nearest known resident within 8.5 km (5.3 mi) in all sectors, which indicated that all of the 16 sectors had no resident population near the site. The resulting population for the 2000 census year is shown on Table 3-33, “Population Levels in the Region of Influence.” Census data for the year 2000 also provided information on the breakdown of the seven counties within 80 km (50 mi) by age (DOC, 2000d). From this data, age groups as a fraction of the total population were determined for infants under one year of age (1.54%), children ages 1-11 (17.90%), teens ages 12-17 (10.93%) and adults ages greater than 17 (69.64%). This breakdown was applied to the total population distribution for all exposure pathways including the determination of annual committed dose equivalent from ingestion and inhalation where age also affects the amount of annual intake (air and food).

For the ingestion of food products, it was assumed that the area produced sufficient volume to supply the entire population with their needs. Individual total effective dose equivalents were calculated for each age group by sector and then multiplied by the estimated age-dependent population for that sector to get the collective dose equivalent. The collective dose equivalents for each age group were then added to provide the total population collective dose equivalents. Table 4-28, “Collective Dose Equivalents to All Ages Population (Person-Seiverts)” and Table 4-29, “Collective Dose Equivalents to All Ages Population (Person-rem)” indicate the total collective dose for the entire population within the 80-km (50-mi) radius of the IIFP site in units of Person-Sieverts and Person-rem, respectively.

Although routine operations at the IIFP facility create the potential for radiological and nonradiological impacts on the environment and members of the public, plant design has incorporated features to minimize gaseous and liquid effluent releases and to keep them well below regulatory limits. These features include:

- DUF₆ cylinders are moved only when cool and when DUF₆ is in solid form, which minimizes the risk of inadvertent release due to mishandling.
- Process off-gas from DUF₆ purification and other operations passes through de-sublimers to solidify and reclaim as much DUF₆ as possible. Remaining gases pass through high-efficiency filters and chemical absorbers, which remove HF and uranium compounds.
- Liquid and solid waste handling systems and techniques are used to control wastes and effluent concentrations.
- Gaseous effluent passes through pre-filters, high efficiency filters, and carbon filters, all of which greatly reduce the radioactivity in the final discharged effluent to very low concentrations.
- Uranium bearing liquid waste is routed to the Decontamination Building for removal of uranium and the treated water is either evaporated or reused in the Decontamination Building.
- Effluent paths are monitored and sampled to assure compliance with regulatory discharge limits.

4.12.3 Environmental Effects of Accidents

The IIFP facility only processes depleted uranium, thus the off-site radiological consequences associated with plant accidents is limited. No nuclear criticality potential exists at the facility and there are no materials on site that contain fission products or transuranic elements. There are, however, large inventories of depleted uranium material on site in the form of DUF₆, DUF₄, and a blend of depleted uranium oxides. There is also a potential to release depleted UO₂F₂ into the environment as a reaction product from a DUF₆ release. In spite of these large inventories, no credible accident has been identified to pose intermediate or high radiological consequences to the public. There are credible intermediate chemical consequence events resulting from potential uranium oxide releases. This is due to the acute chemical exposure of the uranium material, not its radiological component.

Two uranium compounds pose a credible hazard to the off-site environment due to their solubility: UF₆ and UO₂F₂. However, no credible accident is identified that could result in a release of soluble uranium resulting in intermediate or high off-site environmental consequences.

Several credible release scenarios exist at the IIFP facility that could result in both intermediate and high off-site consequences to acute chemical exposure. The three specific chemical compounds and one uranium compound at the plant site that have the potential for intermediate or high chemical consequences to the public are HF, SiF₄, BF₃, and uranium oxide, respectively.

Table 4- 28 Collective Dose Equivalents to All Ages Population (Person-Sv) (gas release pathways)

Sector	0-1.6 km (0-1 mi)	1.6-3.2 km (1-2 mi)	3.2-4.8 km (2-3 mi)	4.8-6.4 km (3-4 m)	6.4-8.0 km (4-5 mi)	8.0-16 km (5-10 mi)	16-32 km (20-30 mi)	32-48 km (20-30 mi)	48-68 km (30-40 mi)	64-80 km (40-50 mi)	Totals
N	0.00E+00	0.00E+00	0.00E+00	0.00E+00	0.00E+00	5.34E-06	7.19E-04	1.53E-05	3.25E-05	1.97E-05	7.92E-04
NNE	0.00E+00	0.00E+00	0.00E+00	0.00E+00	0.00E+00	3.78E-06	8.19E-06	1.02E-05	1.13E-05	1.24E-05	4.58E-05
NE	0.00E+00	0.00E+00	0.00E+00	0.00E+00	0.00E+00	3.82E-06	8.36E-06	1.14E-05	1.02E-05	1.14E-05	4.51E-05
ENE	0.00E+00	0.00E+00	0.00E+00	0.00E+00	0.00E+00	5.01E-06	1.43E-05	2.12E-05	1.93E-05	2.15E-05	8.13E-05
E	0.00E+00	0.00E+00	0.00E+00	0.00E+00	0.00E+00	6.55E-06	2.58E-03	2.67E-05	3.35E-04	3.59E-05	2.98E-03
ESE	0.00E+00	0.00E+00	0.00E+00	0.00E+00	0.00E+00	8.04E-06	2.04E-05	2.34E-05	2.27E-05	6.16E-04	6.90E-04
SE	0.00E+00	0.00E+00	0.00E+00	0.00E+00	0.00E+00	8.01E-06	1.88E-05	2.02E-05	2.23E-05	2.57E-05	9.50E-05
SSE	0.00E+00	0.00E+00	0.00E+00	0.00E+00	0.00E+00	5.92E-06	1.36E-05	1.56E-05	5.16E-05	4.09E-05	2.68E-04
S	0.00E+00	0.00E+00	0.00E+00	0.00E+00	0.00E+00	6.58E-06	1.52E-05	1.87E-05	5.56E-05	2.80E-05	1.24E-04
SSW	0.00E+00	0.00E+00	0.00E+00	0.00E+00	0.00E+00	7.31E-06	1.67E-05	2.06E-05	2.51E-05	1.97E-05	8.94E-05
SW	0.00E+00	0.00E+00	0.00E+00	0.00E+00	0.00E+00	6.12E-06	1.39E-05	1.89E-05	2.31E-05	6.24E-05	1.24E-04
WSW	0.00E+00	0.00E+00	0.00E+00	0.00E+00	0.00E+00	4.44E-06	9.68E-06	1.30E-05	1.60E-05	8.45E-04	8.88E-04
W	0.00E+00	0.00E+00	0.00E+00	0.00E+00	0.00E+00	5.78E-06	1.33E-05	1.73E-05	2.11E-05	2.42E-05	8.16E-05
WNW	0.00E+00	0.00E+00	0.00E+00	0.00E+00	0.00E+00	7.22E-06	1.59E-05	2.02E-05	2.35E-05	2.53E-05	9.22E-05
NW	0.00E+00	0.00E+00	0.00E+00	0.00E+00	0.00E+00	8.89E-06	2.13E-05	2.77E-05	2.72E-05	2.77E-05	1.13E-04
NNW	0.00E+00	0.00E+00	0.00E+00	0.00E+00	0.00E+00	6.90E-06	1.63E-05	1.96E-05	2.29E-05	2.60E-05	9.17E-05
Ring Totals	0.00E+00	0.00E+00	0.00E+00	0.00E+00	0.00E+00	9.97E-05	3.50E-03	4.41E-04	7.19E-04	1.84E-03	6.60E-03
Cum. Totals	0.00E+00	0.00E+00	0.00E+00	0.00E+00	0.00E+00	9.97E-05	3.60E-03	4.04E-03	4.76E-03	6.60E-03	

Table 4- 29 Collective Dose Equivalents to All Ages Population (Person-rem) (gas release pathways)

Sector	0-1.6 km (0-1 mi)	1.6-3.2 km (1-2 mi)	3.2-4.8 km (2-3 mi)	4.8-6.4 km(3-4 m)	6.4-8.0 km (4-5 mi)	8.0-16 km (5-10 mi)	16-32 km (20-30 mi)	32-48 km (20-30 mi)	48-68 km (30-40 mi)	64-80 km (40-50 mi)	Totals
N	0.00E+00	0.00E+00	0.00E+00	0.00E+00	0.00E+00	5.34E-04	7.19E-02	1.53E-03	3.25E-03	1.97E-03	7.92E-02
NNE	0.00E+00	0.00E+00	0.00E+00	0.00E+00	0.00E+00	3.78E-04	8.19E-04	1.02E-03	1.13E-03	1.24E-03	4.58E-03
NE	0.00E+00	0.00E+00	0.00E+00	0.00E+00	0.00E+00	3.82E-04	8.36E-04	1.14E-03	1.02E-03	1.14E-03	4.51E-03
ENE	0.00E+00	0.00E+00	0.00E+00	0.00E+00	0.00E+00	5.01E-04	1.43E-03	2.12E-03	1.93E-03	2.15E-03	8.13E-03
E	0.00E+00	0.00E+00	0.00E+00	0.00E+00	0.00E+00	6.55E-04	2.58E-01	2.67E-03	3.35E-02	3.59E-03	2.98E-01
ESE	0.00E+00	0.00E+00	0.00E+00	0.00E+00	0.00E+00	8.04E-04	2.04E-03	2.34E-03	2.27E-03	6.16E-02	6.90E-02
SE	0.00E+00	0.00E+00	0.00E+00	0.00E+00	0.00E+00	8.01E-04	1.88E-03	2.02E-03	2.23E-03	2.57E-03	9.50E-03
SSE	0.00E+00	0.00E+00	0.00E+00	0.00E+00	0.00E+00	5.92E-04	1.36E-03	1.56E-02	5.16E-03	4.09E-03	2.68E-02
S	0.00E+00	0.00E+00	0.00E+00	0.00E+00	0.00E+00	6.58E-04	1.52E-03	1.87E-03	5.56E-03	2.80E-03	1.24E-02
SSW	0.00E+00	0.00E+00	0.00E+00	0.00E+00	0.00E+00	7.31E-04	1.67E-03	2.06E-03	2.51E-03	1.97E-03	8.94E-03
SW	0.00E+00	0.00E+00	0.00E+00	0.00E+00	0.00E+00	6.12E-04	1.39E-03	1.89E-03	2.31E-03	6.24E-03	1.24E-02
WSW	0.00E+00	0.00E+00	0.00E+00	0.00E+00	0.00E+00	4.44E-04	9.68E-04	1.30E-03	1.60E-03	8.45E-02	8.88E-02
W	0.00E+00	0.00E+00	0.00E+00	0.00E+00	0.00E+00	5.78E-04	1.33E-03	1.73E-03	2.11E-03	2.42E-03	8.16E-03
WNW	0.00E+00	0.00E+00	0.00E+00	0.00E+00	0.00E+00	7.22E-04	1.59E-03	2.02E-03	2.35E-03	2.53E-03	9.22E-03
NW	0.00E+00	0.00E+00	0.00E+00	0.00E+00	0.00E+00	8.89E-04	2.13E-03	2.77E-03	2.72E-03	2.77E-03	1.13E-02
NNW	0.00E+00	0.00E+00	0.00E+00	0.00E+00	0.00E+00	6.90E-04	1.63E-03	1.96E-03	2.29E-03	2.60E-03	9.17E-03
Ring Totals	0.00E+00	0.00E+00	0.00E+00	0.00E+00	0.00E+00	9.97E-03	3.50E-01	4.41E-02	7.19E-02	1.84E-01	6.60E-01
Cum. Totals	0.00E+00	0.00E+00	0.00E+00	0.00E+00	0.00E+00	9.97E-03	3.60E-01	4.04E-01	4.76E-01	6.60E-01	

Being an NRC regulated nuclear facility, established controls to prevent or mitigate any chemical or radiological release at the plant site are beyond those typically deemed appropriate for a modern chemical plant. Credible accident initiators have been identified and subsequent limits and controls established to control the frequency and severity of credible accidents such that acceptable risk to the public is maintained. The determination of acceptable risk is applied as defined in the performance requirements set forth in 10 CFR 70.61 and follows the methodology provided in NUREG-1520. Accidents that pose intermediate consequences to the public are controlled to be unlikely to occur, while those that result in high consequences to the public are controlled to be highly unlikely.

The analytical methods used in the consequence assessment are based on NRC guidance for analysis of nuclear fuel-cycle facility accidents (NRC, 1990; NRC, 1991; NRC, 1998; LES, 2004c). The methodologies and assumptions utilized in the preparation of the consequence assessment are described in the facility ISA documents.

The optional Phase 2 oxide plant is similar to the DUF₄ plant, but with an additional HF distillation process and an end product of depleted uranium oxides. The types of postulated accidents and release scenarios for this plant do not differ from those already addressed in planned, Phase 1 operations. The additional environmental risk of Phase 2 operations is only a result of additional inventory and capacity and is not due to a new type of chemical or radiological risk. The discussion above on the types of Phase 1 accidents and the description of postulated accidents below adequately addresses the range of credible accidents associated with a Phase 2 oxide plant.

4.12.3.1 Description of Postulated Accidents

Postulated accidents are those events described in the Integrated Safety Analysis (ISA) that have, for the uncontrolled case, been categorized as being both credible and having the potential to result in high or intermediate consequences to the worker or the public. Exposure to off-site individuals is estimated assuming worst case conditions for releases from the site and exposures to the public. Bounding inventories and release fractions are assumed while off-site doses are determined at the fenced boundary of the plant, which is within the plant property limits. Actual radiological doses and chemical exposures will be significantly less than these hypothetical values at the plant property line and even to a much greater extent at nearby population centers. The ISA examined a wide range of potential events, sequences and threats to the facility in its analysis. Only those credible events that indicated the potential for intermediate or high consequences for the uncontrolled cases are specifically identified in this section. The postulated credible accidents identified during this ISA process result from both process upset conditions and natural phenomena events (IIFP, 2009)

Postulated High Consequence Events

As mentioned above, no credible radiological releases result in high consequences to the public or worker. The radioactive nature of the site materials along with release mechanisms and inventories are such that high radiological consequences at the fence boundary are not considered credible. A DUF₆ release may result in high off-site chemical consequences due to acute chemical exposure from the HF reaction product and not the radiological dose from the DUO₂F₂ reaction product. The only postulated high consequence events are chemical in nature and involve the release of HF (either a direct release of HF or release of a fluoride-bearing compound and subsequent release of HF as a reaction byproduct). Incidents postulated as high consequence have a very low probability of occurring.

Postulated Intermediate Consequence Events

As mentioned above, no credible radiological releases result in intermediate consequences to the public or worker. The only postulated intermediate consequence events are chemical and result in acute chemical exposure include HF (either a direct release of HF or release of a fluoride-bearing compound and subsequent release of HF as a reaction byproduct), SiF₄, and BF₃. The postulated initiators for these material releases are numerous and include natural phenomena, fire, and process type upset conditions. Incidents postulated as intermediate consequence have a low probability of occurring.

4.12.3.2 Natural Phenomena

Analyses of potential accidents include the effects of natural phenomena. Only a seismic event and wind generated projectiles were identified as potential initiators that result in intermediate or high consequences to the public.

Seismic

A seismic event may produce loads on processing piping and components beyond their capacity to maintain their structural integrity resulting in radiological and hazardous chemical material releases. Additionally, the linear movement may cause motion of certain items such that process piping and components are damaged by impact, which also may result in material releases. In such areas where the radioactive or hazardous chemical release results in high or intermediate consequences to the public, process systems are designed and components restrained to meet a design basis earthquake event. Therefore, given the bounding expected earthquake occurs at the IIFP plant site, it is not expected that a mitigated radiological or hazardous chemical material release will occur such that intermediate or high consequences to the public will result.

Tornado

The buildings are designed to withstand tornado loadings including tornado generated projectiles. The tornado parameters are based on a 100,000-year period of recurrence. This tornado return parameter has been designated as the design basis tornado for the IIFP facility. DUF₆ cylinders stored outside are placed in saddles to prevent movement during a bounding wind event. Additionally, the cylinders are robust vessels that are expected to maintain their structural integrity during impact from a wind generated projectile. Therefore, given that the bounding expected tornado/wind event occurs at the IIFP plant site, it is not expected that a mitigated radiological or hazardous chemical material release will occur such that intermediate or high consequences to the public will result.

4.12.3.3 Fires

Fires are prevented by limiting combustibles and flammable liquids in areas where significant radiological and hazardous chemicals are present. Flammable and explosive gases are also controlled along with potential ignition sources. Within process areas fire suppression system activation contains fires and prevents the breach of process systems and the subsequent release of radioactive and/or hazardous materials. For areas not covered by an automatic sprinkler system, such as outside in the DUF₆ cylinder pads, a plant "fire brigade" assembles to contain the fire. Additionally, local fire fighters are summoned to extinguish the fire prior to a system breach and release of radioactive and/or hazardous material. Therefore, given that a significant fire occurs at the IIFP plant site, it is not expected that a mitigated radiological or hazardous chemical material release will occur such that intermediate or high consequences to the public will result.

4.12.3.4 Process Upsets

The remaining types of initiating events that result in possible intermediate or high chemical consequences to the public are process type upsets/incidents. As mentioned above, no credible process upsets result in intermediate or high radiological consequences to the public or worker. These upsets involve the loss of process and safety controls resulting in the loss of containment of radioactive and hazardous materials. These initiating events are analyzed and documented in the IIFP Process Hazards Analysis in the IIFP ISA. The incidents that lead to a release include the loss of system integrity and the failure to filter, capture, and scrub process byproducts. In most cases adequate controls are in place to prevent a process upset/incident from propagating to the point of a significant radioactive and/or hazardous material release, but in a few cases mitigation controls are established to limit the amount of release off site, such as secondary containment systems. Due to a combination of safety prevention limits and controls and mitigation measures, a significant process upset condition is not expected to result in the mitigated release of radiological or hazardous chemical material such that intermediate or high consequences to the public will result.

4.12.4 Comparative Public and Occupational Exposure Impacts of No-Action Alternative Scenarios

ER Chapter 2 provides a discussion of possible alternatives to the construction and operation of the IIFP facility, including an alternative of "No-Action," i.e., not building the IIFP facility. Additionally, IIFP considered reasonable alternatives using alternative technologies for de-conversion services and production of fluorine products.

4.12.4.1 No-Action Alternative

The DOE de-conversion facilities are sized and built to dispose of the DOE DUF₆ inventory. The de-conversion and disposal is expected to take 20 to 25 years. If DOE were to process privately owned DUF₆, de-conversion would likely have to await completion of the DOE mission or DOE would have to add additional capacity to their plants. A 20 to 25 year delay in processing the DUF₆ would force private enrichment facilities to store tails on site or to build or use their own de-conversion facilities.

The No-Action Alternative of long-term storage of DUF₆ may present potential unnecessary risk to the public. If DOE were to expand its facilities for additional capacity, additional public and occupational exposure impacts will be incurred at Paducah, KY and/or Piketon, OH. If the commercial enrichment facilities had to store tails indefinitely, no additional public and occupational exposure impacts will occur due to additional depleted UF₆ cylinder storage pads required. If the Proposed Action is not implemented, there will be no public and occupational exposure impact to New Mexico.

4.12.4.2 Reasonable Alternatives

One of the Reasonable Alternatives considered utilization of the alternate DOE de-conversion technology on the Proposed IIFP Site near Hobbs, New Mexico. This alternative technology is the same as that which will be used in the de-conversion process utilized at the DOE sites at Paducah, KY and Piketon, OH. With this DOE technology, UF₆ reacts with water and hydrogen to produce uranium oxide, which must be disposed of as waste in a licensed facility, and aqueous HF that has a lower market value than AHF. The public exposure impacts of this alternative are essentially the same as the Proposed Action. The occupational exposure impacts could be lower.

Two of the enrichment companies have de-conversion facilities overseas and could choose to ship their DUF₆ from the U.S. to those facilities for de-conversion. Those companies that do have existing overseas facilities and technologies would be required to ship DUF₆ overseas long-distances and may have to return the waste oxides to United States for licensed disposal or may have to arrange with other countries for disposal. It is expected that public and occupational exposure impacts for this option of shipping the DUF₆ overseas may be similar to the Proposed Action.

The four enrichment companies could decide to build and operate their own de-conversion facilities in the U.S. If those companies were to build new facilities to de-convert “tails” material, it is expected that the public and occupational exposure impacts for this Reasonable Alternative are expected to be similar to the Proposed Action.

See Section 4.12.4.1 for the environmental impacts on public and occupational exposure should the enrichment companies utilize existing DOE de-conversion facilities.

4.13 Waste Management Impacts

Solid waste generated at the IIFP plant will be disposed of at licensed facilities designed to accept the various waste types. Radioactive waste will be collected in labeled containers in each Restricted Area and transferred to a solid waste collection area for inspection. Suitable waste will be volume reduced, where applicable, and all radioactive waste disposed of at a licensed LLW disposal facility. Hazardous and some mixed wastes will be collected at the point of generation, transferred to the solid waste collection area, inspected, and classified. There will be no on-site disposal of solid waste at the IIFP facility. Waste Management Impacts for on-site disposal, therefore, need not be evaluated.

The IIFP facility will generate approximately 164,200 kg (362,000 lb) of *Resource Conservation and Recovery Act* (RCRA) hazardous wastes per year. In New Mexico, hazardous waste generators are classified by the actual monthly generation rate, not the annual average. Given that the average is over 100 kg/mo (220 lb/mo), IIFP will be considered a large quantity generator and will not be conditionally exempt from the New Mexico Hazardous Waste Bureau (NMHWB) hazardous waste regulations. Within 90 days after the generation of any new waste stream, IIFP will need to determine if it is classified as a hazardous waste. If so, IIFP will need to notify the NMHWB within that time period: Without the appropriate RCRA permit, IIFP will not treat, store or dispose of hazardous wastes on site; however, the need for a RCRA permit will be evaluated during the permitting process.

4.13.1 Waste Descriptions

Descriptions of the sources, types and quantities of solid, hazardous, radioactive and mixed wastes generated by IIFP construction and operation are provided in ER Section 3.12; “Waste Management.”

4.13.2 Waste Management System Description

Descriptions of the proposed IIFP waste management systems are provided in ER Section 3.12.

4.13.3 Waste Disposal Plans

4.13.3.1 Radioactive and Mixed Waste Disposal Plans

Solid radioactive wastes are produced in a number of plant activities and require a variety of methods for treatment and disposal. These wastes, as well as the generation and handling systems, are described in detail in ER Section 3.12, "Waste Management."

All radioactive and mixed wastes will be disposed of at off-site, licensed facilities. The impacts on the environment due to these off-site facilities are not addressed in this report. The facilities that may be used to process, or dispose of IIFP radioactive or mixed waste, include Energy Solutions near Clive, UT. Other off-site processing or disposal facilities may be used if appropriately licensed to accept IIFP waste types. The remaining mixed waste will either be pretreated in its collection container on site prior to off-site disposal, or shipped directly to a mixed waste processor for ultimate disposal.

The Clive site, located in South Clive, Utah, is owned and operated privately by Energy Solutions of Utah. This low-level waste disposal site is also licensed in an agreement state in association with 10 CFR 61 (CFR, 2009e), and 40 CFR 264 (CFR, 2009z). Currently, the license allows acceptance of Class A waste only. In addition to accepting radioactive waste, the Clive facility may accept some mixed wastes. This facility is licensed to accept IIFP low-level waste either directly from the IIFP site or as processed waste from off-site waste processing vendors. The disposal site is approximately 1,636 km (1,016 mi) from the IIFP facility.

4.13.3.2 Liquid Wastes

The facility does not discharge any process effluents to natural surface waters or grounds, and there is no tie into a Publicly Owned Treatment Works (POTW). No public impact is expected from routine liquid effluent discharge as no process liquids are discharged off site (process wastes are recycled).

Worker exposure to liquid in plant effluents is minimal. No exposures exceeding 29 CFR 1910, (CFR, 2009b) subpart Z is anticipated. Additionally, handling of all chemicals and waste is conducted in accordance with the site ESH program which conforms to 29 CFR 1920 and specifies the use of appropriate engineered controls, as well as personnel, protective equipment, to minimize potential chemical exposure.

Contaminated water is treated to the limits in 10 CFR 20.2003, 10 CFR 20, Appendix B Table 3 and to administrative levels recommended by Regulatory Guide 8.37 (CFR, 2009a; NRC, 1993). Refer to ER Section 4.4, "Water Resource Impacts," for additional water quality standards and permits for the IIFP facility. ER Section 3.12, "Waste Management," also contains information on the IIFP systems and procedures to ensure water quality

4.13.4 Waste Minimization

The highest priority has been assigned to minimizing the generation of waste through reduction, reuse or recycling. The IIFP plant incorporates several waste minimization systems in its operational procedures that aim at conserving materials and recycling important compounds.

The IIFP facility is designed to minimize the usage of natural and depletable resources. Closed-loop cooling systems have been incorporated in the designs to reduce water usage. Power usage will be

minimized by efficient design of lighting systems, selection of high-efficiency motors, and use of proper insulation materials.

ALARA controls will be maintained during facility operation to account for standard waste minimization practices as directed in 10 CFR 20 (CFR, 2009a). The outer packaging associated with consumables will be removed prior to use in a contaminated area.

4.13.4.1 Control and Conservation

The features and systems described below serve to limit, collect, confine, and treat wastes and effluents that result from the three processes within the IIFP facility. A number of chemicals and processes are used in fulfilling these functions. Waste and effluent control is addressed below as well as the features and systems used to conserve resources.

Mitigating Effluent Releases

The equipment and design features incorporated in the IIFP plant are selected to keep the release of gaseous and liquid effluent contaminants as low as practicable, and within regulatory limits. They are also selected to minimize the use of depletable resources. Equipment and design features for limiting effluent releases during normal operation are described below:

- DUF₆ pressure is raised above atmospheric pressure in the piping and cylinders inside the autoclave. The piping and cylinders inside the autoclave confine the DUF₆. In the event of leakage, the autoclave provides secondary containment of DUF₆.
- Cylinders of DUF₆ are transported only when cool and when the DUF₆ is in solid form. This minimizes risk of inadvertent releases due to mishandling.
- Liquids and solids in the process systems collect uranium compounds. When these liquids and solids (e.g., oils, damaged piping, or equipment) are removed for cleaning or maintenance, portions end up in wastes and effluent. Different processes are employed to separate uranium compounds and other materials from the resulting wastes and effluent. These processes are described in ER Section 4.13.4.2 below.
- In general, careful applications of basic principles for waste handling are followed in all of the systems and processes. Different waste types are collected in separate containers to minimize contamination of one waste type with another. Materials that can cause airborne contamination are carefully packaged; ventilation and filtration of the air in the area is provided as necessary. Liquid wastes are confined to piping, tanks, and other containers; curbing, pits, and sumps are used to collect and contain leaks and spills. Hazardous wastes are stored in designated areas in appropriately labeled containers. Mixed wastes are also contained and stored separately. Strong acids and caustics are neutralized before entering an effluent stream. Radioactively contaminated wastes are decontaminated insofar as possible to reduce waste volume.

Conserving Depletable Resources

The IIFP facility design serves to minimize the use of depletable resources. Water is the primary depletable resource used at the facility. Electric power usage also depletes fuel sources used in the production of the power. Other depletable resources are used only in small quantities. Chemical usage is minimized not only to conserve resources, but also to preclude excessive waste production. Recyclable materials are used and recycled wherever practicable.

The main feature incorporated in the IIFP plant to limit water consumption is the use of closed-loop cooling systems. The IIFP facility is designed to minimize the usage of natural and depletable resources as shown by the following measures:

- The use of low-water consumption landscaping versus conventional landscaping reduces water usage.
- The installation of low flow toilets, sinks and showers reduces water usage when compared to standard flow fixtures.
- Localized floor washing using mops and self-contained cleaning machines reduces water usage compared to conventional washing with a hose twice per week.
- The use of high efficiency washing machines compared to standard machines reduces water usage.
- Closed-loop cooling systems have been incorporated to reduce water usage.

Prevention and Control of Oil Spills

IIFP will implement a spill control program for accidental oil spills. The purpose of the spill control program, in case of a spill occurs, is to minimize the impact of a spill and provide a procedure for the cleanup and reporting of spills. The oil spill control program will be established to comply with the requirements of 40 CFR 112 (CFR, 2009o), “Oil Pollution Prevention”. As required by Part 112, a Spill Prevention, Control, and Countermeasure (SPCC) plan will be prepared prior to either the start of facility operation of the facility or prior to the storage of oil on site in excess of the deminimis quantities established in 40 CFR 112.1(d) (CFR, 2009o). The SPCC Plan will be reviewed and certified by a Professional Engineer and will be maintained on site.

As a minimum the SPCC Plan will contain the following information:

- Identification of potential significant sources of spills and a prediction of the direction and quantity of flow that will result from a spill from each such source;
- Identification the use of containment-type or diversionary structures such as dikes, berms, culverts, booms, sumps, and diversion basins to be used at the facility where appropriate to prevent discharged oil from reaching navigable waters;
- Procedures for inspection of potential sources of spills and spill containment-type/diversion structures; and assigned responsibilities for implementing the plan, inspections, and reporting.

In addition to preparation and implementation of the SPCC Plan, the facility will comply with the specific spill prevention and control guidelines contained in 40 CFR 112.7(e) (CFR, 2009o), such as drainage of rain water from diked areas, containment of oil in bulk storage tanks, above ground tank integrity testing, and oil transfer operational safeguards.

4.13.4.2 Reprocessing and Recovery Systems

Systems used to allow recovery or reuse of materials are described below.

Decontamination Facility

The Decontamination (Decon) Facility contains the area and various equipment and systems for accepting and cleaning uranium contaminated components that may require decontamination prior to maintenance, repair or removing transferrable uranium, if necessary, from items prior to disposition. It also is capable

of receiving and treating wash waters and other low volumes of solutions containing uranium. The significant forms of radioactive contamination found in the plant are depleted uranium oxide, depleted uranium tetrafluoride (DUF₄) and depleted uranyl fluoride (DUO₂F₂).

The Decon facility consists primarily of enclosed dry cleaning and wet-spray booths; receiving and holding tanks for uranium contaminated water; pumps, filters, a 2-stage dust collection system; ion exchange and liquid/solid precipitation separation equipment. Solids collected during cleaning and uranium recovery are expected to be relatively low volume and are packaged for shipping to a licensed off-site disposal facility. Treated liquids (water primarily) are reused in the process or evaporated.

Laundry System

The Laundry System cleans contaminated and soiled clothing and other articles which have been used throughout the plant. It contains the resulting solid and liquid wastes for transfer to appropriate treatment and disposal facilities. The Laundry System receives the clothing and articles from Change/Locker Area in plastic bin bags. The Laundry System collects, sorts, cleans, dries, and inspects clothing and articles used throughout the plant in the various Restricted Areas. The laundry system does not handle any articles from outside the radiological zones.

4.13.5 Comparative Waste Management Impacts of No-Action Alternative Scenarios

ER Chapter 2 provides a discussion of possible alternatives to the construction and operation of the IIFP facility, including an alternative of "No-Action," i.e., not building the IIFP facility. Additionally, IIFP considered reasonable alternatives using alternative technologies.

4.13.5.1 No-Action Alternative

The DOE de-conversion facilities are sized and built to dispose of the DOE DUF₆ inventory. The de-conversion and disposal is expected to take 20 to 25 years. If DOE were to process privately owned DUF₆, de-conversion would likely have to await completion of the DOE mission or DOE would have to add additional capacity to their plants. A 20 to 25 year delay in processing the DUF₆ would force private enrichment facilities to store tails on site or to build or use their own de-conversion facilities.

The No-Action Alternative of long-term storage of DUF₆ may present potential unnecessary risk to the public. If DOE were to expand its facilities for additional capacity, additional waste management impacts will be incurred at Paducah, KY and/or Piketon, OH. If the commercial enrichment facilities had to store tails indefinitely, no additional waste management impacts will occur. If the Proposed Action is not implemented, there will be no waste management impacts to New Mexico.

4.13.5.2 Reasonable Alternatives

One of the Reasonable Alternatives considered utilization of the alternate DOE de-conversion technology on the Proposed IIFP Site near Hobbs, New Mexico. This alternative technology is the same as that which will be used in the de-conversion process utilized at the DOE sites at Paducah, KY and Piketon, OH. With this DOE technology, UF₆ reacts with water and hydrogen to produce uranium oxide, which must be disposed of as waste in a licensed facility, and aqueous HF that has a lower market value than AHF. The waste management impacts of this alternative could be greater than for the Proposed Action.

Two of the enrichment companies have de-conversion facilities overseas and could choose to ship their DUF₆ from the U.S. to those facilities for de-conversion. Those companies that do have existing overseas

facilities and technologies would be required to ship DUF_6 overseas long-distances and may have to return the waste oxides to United States for licensed disposal or may have to arrange with other countries for disposal. It is expected that waste management impacts for this option of shipping the DUF_6 overseas may be greater than the Proposed Action, if aqueous HF generated by this alternative is not marketable or sold. This potentially greater impact is due to the difference in technologies that produce HF, and in the case of aqueous HF, results in the treatment and generation of CaF_2 waste, if that solid waste cannot be sold.

The four enrichment companies could decide to build and operate their own de-conversion facilities in the U.S. If those companies were to build new facilities to de-convert “tails” material, it is expected that the waste management impacts for this Reasonable Alternative are expected to be greater to the Proposed Action, if aqueous HF generated by this alternative is not marketable or sold. This potentially greater impact is due to the difference in technologies that produce HF, and in the case of aqueous HF, results in the treatment and generation of CaF_2 waste, if that solid waste cannot be sold.

See Section 4.13.5.1 for the environmental impacts on waste management should the enrichment companies utilize existing DOE de-conversion facilities.

5. MITIGATION MEASURES

Mitigation measures are those actions or processes that would be implemented to avoid or minimize the magnitude of the impact of the Proposed Action on the affected environment, rectify (i.e., repair, rehabilitate, or restore) the affected environment, or compensate for the impact by providing substitute resources or environments (40 *Code of Federal Regulations* [CFR] 1508.20, “Mitigation”). A standard of significance has been established for assessing environmental impacts. Based on the Council on Environmental Quality’s regulations, each impact is to be assigned one of the following three significance levels:

- **SMALL:** The environmental effects are not detectable or are so minor that they neither destabilize nor noticeably alter any important attribute of the resource.
- **MODERATE:** The environmental effects are sufficient to noticeably alter but not destabilize important attributes of the resource.
- **LARGE:** The environmental effects are clearly noticeable and are sufficient to destabilize important attributes of the resource. (NRC, 2003a)

This chapter of this Environmental Report (ER) summarizes the environmental impacts and the proposed mitigation measures to reduce those potential, adverse impacts (see Chapter 4 of this ER, “Environmental Impacts”) that could result from the pre-licensing and general construction, operation, and decommissioning of the Proposed International Isotopes Fluorine Products (IIFP) Facility. This does not preclude additional mitigation measures that may be implemented by IIFP based upon its consultations with regulatory agencies. Residual adverse impacts that would remain after implementation of mitigation measures are anticipated to be **SMALL**, such that no analyses above and beyond those presented in Chapter 4 are necessary.

5.1 Impact Summary

This section summarizes the environmental impacts that may result from the pre-licensing and general construction, operation, and decommissioning of IIFP facility. Details of these potential impacts are provided in Chapter 4 of this Environmental Report

5.1.1 Land Use

Land use impact has been characterized in ER Section 4.1, “Land Use Impacts.” The land use impacts resulting from the Proposed IIFP Facility effectively could be considered cumulative for the pre-licensing and general construction, operation, and decommissioning phases. Once the land on the proposed site is cleared to begin preconstruction and construction activities, the approximately 40-acre Site could be used continuously as an industrial or business site after the facility’s decommissioning and closure. The cumulative land use impacts resulting from the Proposed IIFP Facility would be **SMALL**.

Minor impacts related to erosion control on the site may occur, but are short-term and limited. Mitigation measures associated with these impacts are listed in ER Section 5.2.1, “Land Use.”

5.1.2 Transportation

Transportation impact has been characterized in ER Section 4.2, "Transportation Impacts."

With respect to construction-related transportation, SMALL to MODERATE impacts exist as related to the following:

- Construction of the access road to the facility. A construction access road will be built from NM 483. The road will be converted to a permanent site access road upon completion of construction.
- Transportation route and mode for conveying construction material to the facility.
- Traffic pattern impacts (e.g., from any increase in traffic from heavy haul vehicles and construction worker commuting).
- Impacts of construction transportation such as fugitive dust, scenic quality, and noise.

Mitigation measures associated with transportation impacts are listed in ER Section 5.2.2, "Transportation." The increased automobile and truck traffic associated with the Proposed IIFP Facility would increase motor vehicle air emissions and traffic noise in the vicinity of the site. Air emissions and noise impacts from the motor vehicle traffic accessing the Proposed IIFP Facility are discussed, respectively, in Section 4.6, "Air Quality Impacts," and Section 4.7, "Noise Impacts."

With respect to the transport of radioactive materials, no substantive impacts exist as related to the following activities:

- Transportation mode (i.e., truck), and routes from originating site to the destination.
- Estimated transportation distance from the originating site to the destination.
- Treatment and packaging procedure for radioactive wastes.
- Radiological dose equivalents for incident-free scenarios to public and workers.
- Operating transportation vehicles on the environment (e.g., fire from equipment sparking).

Impacts related to the transport of radioactive material are addressed in ER Section 4.2.6, "Radioactive Material Transportation." The materials that will be transported to and from the IIFP facility are well within the scope of the environmental impacts previously evaluated by the Nuclear Regulatory Commission (NRC). Because these impacts have been addressed in a previous NRC environmental impact statement (NUREG/CR-0170) (NRC, 1977a), no additional mitigation measures are proposed in ER Section 5.2.2, "Transportation."

5.1.3 Geology and Soils

The potential impacts to the geology and soils have been characterized in ER Section 4.3, "Geology and Soils Impact." SMALL impacts exist as related to the following activities:

- Soil resuspension, erosion, and disruption of natural drainage.
- Excavations to be conducted during construction.
- Decommissioning of the IIFP facility.

The Lea County Soils Survey (USDA, 1974) describes soils found at the IIFP site as applicable for range, wildlife and recreation areas, and not for any standard agricultural activities. Pre-licensing and general construction and operation of the IIFP plant are thus not anticipated to displace any potential agrarian use.

Construction activities may cause some short-term increases in soil erosion at the site. Mitigation measures associated with these impacts are listed in ER Section 5.2.3, "Geology and Soils."

5.1.4 Water Resources

The potential impacts to the water resources have been characterized in ER Section 4.4, "Water Resources Impacts." SMALL impacts exist as related to the following:

- Surface water and groundwater quality;
- Consumptive water uses (e.g., groundwater depletion) on other water users and adverse impacts on surface-oriented water users resulting from facility activities;
- For potable, process, and fire water, IIFP will use two wells in the Ogallala Aquifer. Average and peak potable water requirements for operation of the IIFP plant are expected to be approximately 11.4 m³/day (3,000 gpd) and 37.9 m³/day (10,000 gpd), respectively;
- Hydrological system alterations or impacts;
- Withdrawals and returns of ground and surface water;
- Decommissioning of the facility; and
- Cumulative effects on water resources.

There are no process liquid effluents discharged from the facility, process waters are either reused within the process or evaporated, where feasible. Sanitary waste water discharges will be made through a packaged tertiary treatment unit. Storm-water from developed portions of the site will be collected in Stormwater Retention Basins, as described in ER Section 3.4, "Water Resources." Minor impacts to water resources are discussed in ER Section 4.4. Mitigation measures associated with these impacts are listed in ER Section 5.2.4, "Water Resources."

5.1.5 Ecological Resources

The potential impacts to the ecological resources have been characterized in ER Section 4.5, "Ecological Resources Impacts." SMALL impacts exist as related to the following:

- Total area of land to be disturbed;
- Use of chemical herbicides, roadway maintenance, and mechanical clearing;
- Areas to be used on a short-term basis during construction;
- Noise impacts to wildlife;
- Overall indirect impacts from non-radiological air emissions;
- Communities or habitats that have been defined as rare or unique or that support threatened and endangered species;
- Impacts of elevated construction equipment or structures on species (e.g., bird collisions, nesting areas);
- Impact on important biota; and
- Decommissioning of the Proposed IIFP Facility.

MODERATE impacts exist for travel corridors, area of disturbance for each habitat type, and habitat quality.

Impacts to ecological resources will be minimal. Mitigation measures associated with these impacts are listed in ER Section 5.2.5, "Ecological Resources."

5.1.6 Air Quality

The potential impacts to the air quality have been characterized in ER Section 4.6, “Air Quality Impacts.” SMALL impacts exist from the pre-licensing and general construction, operation, and decommissioning as related to the following activities:

- Gaseous effluents.
- Visibility impacts.

There would be no substantive impacts to air quality. Construction activities will result in interim increases in hydrocarbons and particulate matter due to vehicle emissions and fugitive dust. Impacts due to plant operation consist of trace amounts of HF, SiF₄, BF₃, and uranic compound effluents remaining in treated air emissions from plant ventilation systems. These effluents are significantly below regulatory limits. Mitigation measures associated with air quality impacts are listed in ER Section 5.2.6, “Air Quality.”

5.1.7 Noise

The potential impacts related to noise generated during the pre-licensing and general construction, operation, and decommissioning by the facility have been characterized in ER Section 4.7, “Noise Impacts.” SMALL impacts exist as related to the following activities:

- Traffic noise;
- Predicted noise levels at surrounding industrial facilities; and
- Impacts to sensitive receptors (i.e., residences and wildlife).

Noise levels will increase during the construction phases and due to operation of the IIFP plant, but not to a level that will cause significant impact to nearby sensitive receptors. The nearest residence is approximately 8.5 km (5.3 mi) from the site. Mitigation measures associated with noise impacts are listed in ER Section 5.2.7, “Noise.”

5.1.8 Historical and Cultural Resources

The potential impacts to historical and cultural resources have been characterized in ER Section 4.8, “Historical and Cultural Resource Impacts.” SMALL impacts exist as related to the following activities:

- Pre-licensing and general construction, operation, or decommissioning;
- Historic properties;
- Potential for human remains to be present in the project area; and
- Archeological resources.

Impacts to Historical and Cultural Resources will be minimal. Mitigation measures associated with these impacts, if required, are listed in ER Section 5.2.8, “Historical and Cultural Resources.”

5.1.9 Visual/Scenic Resources

The potential impacts to visual/scenic resources have been characterized in ER Section 4.9, "Visual/Scenic Resources Impacts." SMALL impacts during the pre-licensing and general construction, operation, and decommissioning of the Proposed IIFP Facility exist as related to the following:

- The aesthetic and scenic quality of the site;
- Visual impacts from physical structures;
- Historical, archaeological or cultural properties of the site; and
- Character of the site setting.

Visual/scenic impacts due to the development of the IIFP plant result from visual intrusions in the existing landscape character. No structures are proposed that may require the removal of natural or built barriers, screens or buffers. Mitigation measures associated with these impacts are listed in ER Section 5.2.9, "Visual/Scenic Resources."

5.1.10 Socioeconomic

The potential socioeconomic impacts to the community have been characterized in ER Section 4.10, "Socioeconomic Impacts." SMALL impacts during the pre-licensing and general construction, operation, and decommissioning of the facility exist as related to the following:

- Population characteristics (e.g., ethnic groups, and population density);
- Housing, health and social services, or educational and transportation resources; and
- Area's tax structure and distribution.

The anticipated cumulative socioeconomic negative impacts of the proposed operation of the IIFP facility are expected to be SMALL. The positive socioeconomic impacts are substantial (see ER Section 7.1, "Proposed Action Economic Cost-Benefits, Facility Construction and Operation"). See ER Section 4.10, "Socioeconomic Impacts," for a detailed discussion on socioeconomic impacts.

5.1.11 Environmental Justice

Census Block Groups (CBG) within the 130 km² (50 mi²) of the IIFP site contained minority or low-income populations exceeding the NUREG-1748 "20%" or "50%" criteria. An examination was made to determine whether there are disproportionately high minority or low-income populations residing within a 6.4 km (4 mi) radius of the IIFP facility.

The potential impacts with respect to environmental justice have been characterized in ER Section 4.11, "Environmental Justice." No substantive impacts exist as related to the disproportionate impact to minority or low-income population.

5.1.12 Public and Occupational Health

This section describes public and occupational health impacts from both nonradiological and radiological sources.

5.1.12.1 Nonradiological–Normal Operations

The potential impacts to public and occupational health from nonradiological sources have been characterized in ER Section 4.12.1, “Nonradiological Impacts.” SMALL impacts exist as related to the following:

- Members of the public from nonradiological discharge of liquid or gaseous effluents to water or air;
- Facility workers as a result of occupational exposure to nonradiological chemicals, effluents, and wastes; and
- Cumulative impacts to public and occupational health.

Impacts to the public and workers from nonradiological gaseous and liquid effluents will be minimal. Mitigation measures associated with these impacts are listed in ER Section 5.2.12.1, “Nonradiological–Normal Operations.”

5.1.12.2 Radiological–Normal Operations

Section 4.12.2, “Radiological Impacts”, describes public and occupational health impacts from radiological sources. An assessment of pathways that could convey radioactive material to members of the public was conducted to evaluate the potential for exposure to radiological sources.

Potential points or areas were characterized to identify the:

- Nearest site boundary;
- Nearest full time resident; and
- Nearest industrial facility.

In addition, important ingestion pathways such as stored and fresh vegetables, milk and meat, assumed to be grown or raised at the nearest resident location were analyzed. There are no off-site releases to any surface waters or Publicly Owned Treatment Works (POTW).

The potential impacts to public and occupational health for radiological sources have been characterized in ER Section 4.12, “Public and Occupational Health Impacts.” No substantive impacts exist as related to the following:

- The average annual concentration of radioactive and hazardous materials in gaseous and liquid effluents;
- The public, nearest resident and nearest industrial facility;
- Workforce based on radiological and chemical exposures; and
- Reasonably foreseeable (i.e., credible) accidents with the potential to result in environmental releases.

Routine operations at the IIFP plant create the potential for radiological and nonradiological public and occupational exposure. Radiation exposure is due to the plant’s use of depleted uranium and the presence of associated decay products. Chemical and radiological exposures are primarily from DUF₆, SiF₄, BF₃, depleted uranium oxides, anhydrous hydrogen fluoride, and related uranic compounds.

These are the primary products of concern in gaseous effluents that will be released from the plant and liquid effluents that will be released to the on-site holding tanks. Mitigation measures associated with these impacts are listed in ER Section 5.2.12, "Public and Occupational Health."

5.1.12.3 Environmental Effects of Accidents

Credible accident sequences were considered during the Integrated Safety Analysis (ISA) performed for the facility (IIFP, 2009). Accidents evaluated fell into two general types: Fire and HF/DUF₆ releases. Some HF/DUF₆ release scenarios were shown to result in potential radiological and HF chemical exposures to the public. Gaseous releases of DUF₆ react quickly with moisture in the air to form HF and UO₂F₂. Consequence analyses showed that HF was the bounding consequence for all gaseous DUF₆, SiF₄, and BF₃ releases to the environment.

Potential adverse impacts for accident conditions are described in ER Section 4.12.3, "Environmental Effects of Accidents." Mitigation measures associated with these impacts are listed in ER Section 5.2.12.3, "Environmental Effects on Accidents."

5.1.13 Waste Management

The potential impacts of waste generation and waste management have been characterized in ER Section 4.13, "Waste Management Impacts." SMALL impacts exist as related to the following:

- Public due to the composition and disposal of solid, hazardous, radioactive and mixed wastes;
- Facility workers due to storage, processing, handling, and disposal of solid, hazardous, radioactive and mixed wastes; and
- Cumulative impacts of waste management.

Waste generated at the IIFP plant will be comprised of industrial (nonhazardous), radioactive and mixed, and hazardous waste categories. Gaseous and liquid effluent impacts are discussed in ER Section 5.1.12.2, "Radiological–Normal Operations." Mitigation measures associated with waste management are listed in ER Section 5.2.13, "Waste Management."

5.2 Mitigations

This section summarizes the mitigation measures that are in place to reduce adverse impacts that may result from the construction and operation of the IIFP facility. The residual impacts, which will remain after application of the mitigation measures, are of a very small magnitude.

5.2.1 Land Use

The anticipated effects on the land use during construction activities are limited to a potential short-term increase in soil erosion. However, this impact will be mitigated by following construction BMP (best management practices) including:

- Minimizing the construction footprint to the extent possible;
- Limiting site slopes to a horizontal to vertical ratio of three to one;
- Use of a sediment retention basin;
- Protection of undisturbed areas with silt fencing and straw;
- Site stabilization by placing crushed stone on areas of concentrated runoff; and

- Site stabilization practices to reduce the potential for erosion and sedimentation. Additional discussion is provided in ER Section 5.2.3, "Geology and Soils."
- After construction is complete, the site will be stabilized with natural, low-water maintenance landscaping and pavement.

These practices include the placement of waste receptacles and trash dumpsters at convenient locations and the designation of vehicle and equipment maintenance areas for the collection of oil, grease and hydraulic fluids. Where practicable, materials suitable for recycling will be collected. If external washing of construction vehicles is necessary, no detergents will be used, and the runoff will be diverted to on-site retention basins. Adequately maintained sanitary facilities will be provided for construction crews.

Incorporating the mitigating measures and actions will result in minimal overall land-use impacts to the site and vicinity considering that the majority of the site will remain undeveloped. IIFP is not aware of any federal action that would have cumulatively significant land-use impacts requiring mitigation measures

5.2.2 Transportation

Mitigation measures will be in place to minimize potential impact of construction-related transportation activities. To control fugitive dust production, reasonable precautions will be taken to prevent particulate matter from becoming airborne including the following actions:

- The use of water to control dust on dirt roads in clearing and grading operations and construction activities. Water conservation will be considered when deciding how often dust suppression sprays will be applied.
- The use of adequate containment methods during excavation or similar activities.
- Cover open bodied trucks where it is appropriate and needed. Open-bodied trucks transporting materials likely to give rise to airborne dust will be covered when in motion.
- Prompt removal of earthen materials on paved roads deposited by trucks or earth moving equipment, or by wind erosion.
- Prompt stabilization or covering of bare areas once earth moving activities are completed.
- Operation of construction equipment and related vehicles with standard pollution control devices maintained in good working order.
- Designated personnel to monitor dust emissions and direct increase watering where necessary.
- During the course of construction, short-duration activities (e.g., concrete trucks, multiple deliveries) with potential traffic impact, these will be scheduled to minimize traffic impacts.
- Work shifts will be implemented throughout the construction phases to minimize impacts to traffic in the site vicinity.

Considering the amount of traffic that nearby roadways experience on a daily average, the increase in vehicle flow associated with site construction and on-site operations would be insignificant. Generally, as the distance from the site increases, impacts to the transportation network decrease as traffic becomes more dispersed. Additionally, incorporating these mitigation actions listed during construction will result in minimal impacts for transportation. Control measures that can be used to mitigate the motor vehicle traffic impacts on U.S. 62/180 and NM 483 in the immediate vicinity of the IIFP facility with the

connecting roads to the other communities due to the pre-licensing and general construction, operation, and decommissioning of the Proposed IIFP Facility include the following:

- Schedule Proposed IIFP Facility operations worker shift changes and truck shipments for off-peak traffic periods, when practical.
- Explore adding a traffic light at the intersection of US 62/180 and NM 483.
- Explore adding a traffic light on NM 483 at the plant entrance.

5.2.3 Geology and Soils

Mitigation measures will be in place during pre-licensing and general construction, operations, and decommissioning to minimize impact to geology and soils. These measures include:

- Erosional impacts due to site clearing and grading will be mitigated by utilization of construction and erosion control BMPs, some of which are further described below.
- Disturbed soils will be stabilized by acceptable means as part of the construction work.
- Earthen berms, dikes and sediment fences will be utilized as necessary during construction phases to limit suspended solids in runoff.
- Cleared areas not covered by structures or pavement will be stabilized by acceptable means as soon as practical.
- Watering may be used to control fugitive dust.
- Collect surface runoff in temporary retention basins (during construction) and permanent retention/evaporation basins (during operations).
- Standard drilling and blasting techniques, if required, will be used to minimize impact to bedrock; reducing the potential for over excavation thereby minimizing damage to the surrounding rock.
- Drainage culverts and ditches will be stabilized and lined with rock aggregate to reduce flow velocity.
- Soil stockpiles generated during construction will be placed in a manner to reduce erosion.
- Excavated materials will be reused whenever possible.
- Routine visual inspections and preventive maintenance will be conducted.
- Above ground storage tanks of appropriate materials will be constructed.
- Secondary containment for tanks storing petroleum products and hazardous chemicals will be used.
- Berms will be utilized and Spill Prevention Control and Countermeasures Plan will be implemented.
- Spill cleanup materials in the areas of fuel line and tank hose connections will be maintained.
- Contaminated soils will be sampled, analyzed, and managed in accordance with NRC, State, and other Federal requirements.
- An approved Decommissioning Plan for ultimate NRC release of the site for unrestricted use and license termination will be established and implemented.

5.2.4 Water Resources

Mitigation measures will be in place to minimize potential impact on water resources during pre-licensing and general construction, operations, and decommissioning of the IIFP facility. As discussed in ER Section 4.4.7, "Control of Impacts to Water Quality," there is little impact on any groundwater or surface water resources. These mitigation measures also prevent soil contamination. These include employing BMPs and the control of hazardous materials and fuels. In addition, the following controls are also implemented:

- Construction equipment will be in good repair without visible leaks of oil, greases, or hydraulic fluids.
- Control of spills during construction will be in conformance with the Spill Prevention Control and Countermeasures Plan procedures.
- Use of BMPs will assure storm-water runoff related to these activities will not release runoff into nearby sensitive areas.
- BMPs will also be used for dust control associated with excavation and fill operations during construction. Water conservation will be considered when deciding how often dust suppression sprays will be applied.
- Silt fencing and sediment traps will be used.
- Stone construction pads will be placed at entrance/exit if unpaved construction access adjoins a state road.
- Basins are arranged to provide for the prompt, systematic sampling of runoff in the event of any special needs.
- Water quality impacts will be controlled during construction phases by compliance with the National Pollution Discharge Elimination System General Permit requirements and by applying BMPs as detailed in the Stormwater Pollution Prevention Plan.
- A Spill Prevention Control and Countermeasure Plan will be implemented for the facility to identify potential spill substances, sources and responsibilities.
- All above ground petroleum storage tanks will be bermed.
- Conduct routine visual inspections and preventive maintenance.
- Any hazardous materials will be handled by approved methods and shipped off site to approved disposal sites. Sanitary wastes generated during site construction will be handled by portable systems; until such time that the plant sanitary waste treatment facility is available for use.
- The facilities liquid effluent collection and treatment system provides a means to control liquid waste with the plant including the collection, evaporation, and minimization of liquid wastes for disposal.
- Liquid effluent concentration release to the evaporative tank will be below 10 CFR 20 uncontrolled release limits.
- Control of surface water runoff will be required for activities as covered by the NPDES General Permit. As a result, no impacts are expected to surface or groundwater bodies.
- Stormwater and effluent sampling would be conducted as necessary by the NPDES permit to protect surface water quality. In addition, site-wide groundwater levels would continue to be monitored routinely, and the groundwater monitoring-well and pumping-well networks would continue to be analyzed to confirm that the changes in groundwater levels associated with the Proposed Action are minimal.

The IIFP site is designed to minimize the usage of natural and depletable resources as shown by the following measures:

- Use of low-water consumption landscaping;
- Installation of low-flow toilets, sinks and showers;
- Localized floor washing using mops and self-contained cleaning machines reduces water usage compared to conventional washing with a hose;
- Installation of high-efficiency washing machines;
- Closed-loop cooling systems will be incorporated where possible;
- The Site Stormwater Retention Basin is designed to contain the “100-year rain;”and
- Process waste water is treated and recycled. Any small amounts of excess water from miscellaneous processes would be retained in a storage tank and sent to an evaporator.

5.2.5 Ecological Resources

Mitigation measures will be in place to minimize the potential impact on ecological resources during construction activities, operations and decommissioning of the facility. These include:

- Use of BMPs recommended by the State of New Mexico or various federal agencies;
- No herbicides will be used during construction, but may be used in limited amounts according to government regulations and manufacturer's instructions to control unwanted noxious vegetation during operation of the facility;
- Minimize the construction footprint to the extent possible;
- The use of retention (evaporation) basins to avoid direct discharge of stormwater runoff from process areas to any waters of the United States; and
- Implement site stabilization practices to reduce the potential for erosion and deposition of sediment. After construction is complete, the site will be stabilized with native grass species, pavement, and crushed stone to control erosion. Ditches, unless excavated in rock, will be lined with riprap, vegetation, or other suitable material as dictated by water velocity to control erosion. Furthermore, any eroded areas that may develop will be repaired and stabilized.

Proposed practices to minimize impact to wildlife include:

- Placement of a raptor perch in an unused open area;
- Install bird feeders at the visitor's center;
- Placement of quail feeders in the unused open areas away from buildings;
- The management of unused open areas, including areas of native grasses and shrubs for the benefit of wildlife;
- Use native plant species (i.e., low-water consuming plants) to vegetate disturbed areas and to enhance wildlife habitat;
- Use netting, or other suitable material, to ensure migratory birds are excluded from retention (evaporation) basins that do not meet New Mexico Water Quality Control Commission surface water standards for wildlife usage;
- Use animal friendly fencing within the Site so that wildlife cannot be injured or entangled;
- Minimize the amount of open trenches at any given time; and
- Treat or recycle of process air-scrubbers system liquids.

In addition to proposed wildlife management practices above, IIFP will consider recommendations from appropriate state and federal agencies, including the United States Fish and Wildlife Service and the New Mexico Department of Game and Fish.

5.2.6 Air Quality

Air concentrations of the Criteria Pollutants for vehicle emissions and fugitive dust will be below the NAAQS and thus will not require mitigation measures. Visibility impacts from fugitive dust emissions will be minimized by watering of the site during the construction phases to suppress dust emissions. Water conservation will be considered when deciding how often dust suppression sprays will be applied.

Mitigation measures for credible accident scenarios considered in the Integrated Safety Analysis Report (ISA) (IIFP, 2009) are summarized in ER Section 4.12, "Public and Occupational Health Impacts" and ER Section 5.2.12, "Public and Occupational Safety."

Mitigation measures will be in place to minimize potential impact on air quality. These include the following items:

- Process design features to inherently lower the potential for air emissions;
- Construction BMPs will be applied as described previously to minimize fugitive dusts;
- Monitoring and inspection programs to detect any air emissions from equipment malfunction so that corrective action can be taken promptly;
- Work practices to prevent or reduce air emissions releases;
- Maintain air concentrations of criteria pollutants for vehicle emissions and fugitive dust below the National Ambient Air Quality Standards (NAAQS) (CFR, 2009h); and
- Air emissions control systems (i.e., scrubber systems and dust collectors) are designed to collect and clean potentially hazardous gases from the plant effluents prior to release into the atmosphere.
- Emission Stacks are sampled continuously and routinely analyzed.

Air quality impacts will occur during decommissioning work, such as fugitive dust, vehicle exhaust, portable generator exhaust, air compressor exhaust, cutting torch fumes and solvent fumes. Fugitive dust and vehicle exhaust during decommissioning are assumed to be bounded by the emissions during construction. Similar mitigation measures will be used.

5.2.7 Noise

Noise from construction activities will have the highest sounds levels, but the nearest home is located approximately 8.5 km (5.3 mi) from the site. Due to this distance, those residents will not perceive an increase in noise levels. There are no sensitive receptors (hospitals, schools, residences) located near to the intersection of U.S. 62/180 and NM 483 at Arkansas Junction who would have been the most aware of the increase in traffic due to proximity to the source. However for mitigation measures, heavy truck and earth moving equipment usage will be restricted after twilight and during early morning hours. Noise suppression systems on construction vehicles will be kept in proper operation.

Cumulative impacts from site noise sources should typically remain at or below HUD guidelines of 65 dBA Ldn, and the EPA guidelines of 55 dBA Ldn, (EPA, 1973) during IIFP facility construction and operation. Mitigation of the operational noise sources will occur primarily from the plant design, equipment and physical structures. The buildings themselves will absorb the majority of the noise located within. Natural land contours, vegetation (such as scrub brush), and site buildings and structures will mitigate the impact of other equipment located outside of structures that contribute to site noise levels. Distance from the noise source is also a key factor in the control of noise levels to area receptors. It is generally true that the sound pressure level from an outdoor noise source decreases 6 dB per doubling of distance (Cowan, 1994).

5.2.8 Historical and Cultural Resources

From a pedestrian cultural survey of the site, three isolated occurrences have been completely recorded in a manner consistent with current standards and do not require any additional work. A check of files yielded three previous NMCRIS activities, but no previously recorded sites within 1 km (0.62 mi) of the project area. The proposed IIFP undertaking will have no effect on historical and cultural resources.

In the event that an inadvertent discovery of human remains or other item of archeological significance is made during construction, the facility will cease construction activities in the area around the discovery

and notify the New Mexico State Historic Preservation Officer, to make the determination of appropriate measures to identify, evaluate, and treat these discoveries.

Mitigation of the impact to historical and cultural sites within the IIFP project boundary can take a variety of forms. Avoidance and data collection are the two most common forms for sites considered eligible based on National Register of Historic Places (NRHP) (USC, 2009c) criteria. When possible, avoidance is the preferred alternative because the site is preserved in place and mitigation costs are minimized. When avoidance is not possible, data collection becomes the preferred alternative. Data collection proceeds after the sites have been determined eligible. A treatment plan is submitted to the appropriate regulatory agencies. The plan describes the expected data content of the sites and how data will be collected, analyzed, and reported. A treatment/mitigation plan will be developed by IIFP, if necessary.

5.2.9 Visual/Scenic Resources

By considering both proposed on-site and nearby existing developments, modification to the subject site will not add significantly to its visual degradation. Therefore, there will be a SMALL cumulative impact on the visual/scenic quality of the IIFP site.

Mitigation measures will be in place to minimize the impact to visual and scenic resources. These include:

- The use of accepted natural, low-water consumption landscaping techniques to limit any potential visual impacts. These techniques will incorporate, but not be limited to, the use of landscape plantings. As for aesthetically pleasing screening measures, planned landscape plantings will include indigenous vegetation.
- Prompt natural re-vegetation or covering of bare areas will be used to mitigate visual impacts due to construction activities.

5.2.10 Socioeconomic

A small increase in population would produce a minor impact on population characteristics, economic trends, housing, community services (health, social and educational resources), and the tax structure within Hobbs, Eunice, and Lovington, New Mexico, and Andrews and Seminole, Texas, during both the pre-licensing and general construction and operation periods of the IIFP plant. No socioeconomic mitigation measures are anticipated.

5.2.11 Environmental Justice

Because the CBG in which the facility is located has no minority and low-income residents within a 4-mile radius (50 mi²) of the plant, pre-licensing and general construction, operation, and decommissioning of the facility is not expected to result in disproportionately high or adverse impacts on minority or low-income populations. No environmental justice concerns are expected. No environmental justice mitigation measures are anticipated.

5.2.12 Public and Occupational Health

This section describes the mitigation measures to minimize public and occupational health impacts, from both nonradiological and radiological sources.

5.2.12.1 Nonradiological-Normal Operation

Mitigation measures will be in place to minimize the impact of nonradiological gaseous and liquid effluents to well below regulatory limits. The plant design incorporates numerous features to minimize potential gaseous and liquid effluent impacts including:

- The facility incorporates “state of the art” technology for handling AHF. AHF is stored in 3,630-kg (8,000-lb) storage vessels to limit inventory should a leak occur.
- AHF storage vessels are located in a building with containment-type capabilities.
- DUF₆ cylinders are moved only when cool and when DUF₆ is in solid form, minimizing the risk of inadvertent release due to mishandling.
- Liquid and solid waste handling systems and techniques are used to control wastes and to limit exposure.
- Gaseous effluent passes through pre-filters, high efficiency filters and scrubbers, all of which reduce the radioactive and chemical constituents in the final discharged effluent to very low concentrations.
- Miscellaneous small quantities of liquid waste are routed to a collection tank and evaporator.
- IIFP has a process safety program relating to hazardous materials as defined in OSHA 1910.119.
- IIFP has an Emergency Response Plan to address response issues.
- Wherever possible, IIFP will operate some process systems at below atmospheric pressure to prevent leaks to the atmosphere.
- DUF₆ process systems are monitored by instrumentation, which will activate alarms in the control room and will either automatically shut down the plant to a safe condition or alert operators to take the appropriate actions in the event of operational problems.

Administrative controls, practices, and procedures are used to assure compliance with IIFP’s Health, Safety, and Environmental Program. The program is designed to ensure, safe storage, use and handling of chemicals to minimize the potential for worker exposure.

5.2.12.2 Radiological-Normal Operations

Mitigation measures to minimize the impact of radiological gaseous and liquid effluents include those listed in ER Section 5.2.12.1, “Nonradiological – Normal Operations.” The equipment and design features incorporated in the IIFP facility are selected to keep the release of gaseous and liquid effluent contaminants as low as practicable, and within regulatory limits. They are also selected to minimize the use of depletable resources. Additional features for limiting effluent releases during normal operation are described below:

- DUF₆ pressure is raised above atmospheric pressure in the piping and cylinders inside the autoclave. The piping and cylinders inside the autoclave confine the DUF₆. In the event of leakage, the autoclave provides secondary containment of DUF₆.
- Cylinders of DUF₆ are transported only when cool and when the DUF₆ is in solid form. This minimizes risk of inadvertent releases due to mishandling. See additional mitigation measures below.
- Processes used to clean up wastes and effluents create their own wastes and effluent as well. Control of these is accomplished by liquid and solid waste handling systems and techniques. Different waste types are collected in separate containers to minimize contamination of one waste type with another. Materials that can cause airborne contamination are carefully packaged; ventilation and filtration of the air in the area is provided as necessary. Liquid wastes are confined

to piping, tanks, and other containers. Curbing, pits, and sumps are used to collect and contain leaks and spills. Hazardous wastes are stored in designated areas in labeled containers. Mixed wastes are also contained and stored separately. Radioactive contaminated wastes are decontaminated insofar as possible to reduce waste volume.

Further details of these features are contained in the License Application Chapter 3, “Integrated Safety Analysis Summary” (IIFP, 2009).

Mitigation measures associated with DUF₆ cylinder storage areas as follows:

- IIFP will maintain a cylinder management program to monitor storage conditions on the staging pad to monitor cylinder integrity by conducting routine inspections for breaches, and to perform cylinder maintenance and repairs as needed.
- Cylinders filled with depleted uranium hexafluoride (DUF₆) will be stored on concrete (or other material) saddles that do not cause corrosion of the cylinders. These saddles shall be placed on a concrete pad.
- DUF₆ cylinders shall be surveyed for external contamination (wipe tested), prior to being placed on the staging pad or transported off site. The maximum level of removable surface contamination allowed on the external surface of the cylinder shall be no greater than 0.4 Bq/cm² (22 dpm/cm²) (beta, gamma, alpha) on accessible surfaces averaged over 300 cm².
- Cylinder valves shall be fitted with valve guards to protect the cylinder valve during transfer and storage.
- Provisions are in place to ensure that DUF₆ cylinders do not have non-conforming valves installed (identified in NRC Bulletin 2003-03, “Potentially Defective 1-Inch Valves for Uranium Hexafluoride Cylinders”) (NRC, 2003b).
- Only designated vehicles with less than 280 l (74 gal) of fuel shall be allowed on the cylinder storage pads.
- Cylinders shall be inspected. These inspections shall verify that:
 - Lifting points are free from distortion and cracking.
 - Cylinder skirts and stiffener rings are free from distortion and cracking.
 - Cylinder surfaces are free from bulges, dents, gouges, cracks, or significant corrosion.
 - Cylinder valves are fitted with the correct protector and cap.
 - Cylinders are inspected to confirm that the valve is straight and not distorted, two to six threads are visible, and the square head of the valve stem is undamaged.
 - Cylinder plugs are undamaged and not leaking.

Additional measures to minimize radiological exposure and release are listed below. Radiological practices and procedures are in place to ensure compliance with the IIFP Radiation Protection Program. This program is designed to achieve and maintain radiological exposure to levels that are “as low as reasonably achievable” (ALARA). These measures include:

- Routine plant radiation and radiological surveys to characterize and minimize potential exposures;
- Monitoring of all radiation workers via the use of dosimeters, urinalysis and area air sampling to ensure that radiological parameters remain within regulatory limits and are ALARA;
- Nonradiological as well as radiological monitoring at the nearest resident;
- Monitoring of stacks for uranium;
- Fence-line TLD monitors and continuous monitors;

- Area vegetation/soil monitoring on a quarterly basis, and
- Groundwater monitoring.

Further details of these features are contained in ER Chapter 6, “Environmental Measurements and Monitoring Programs.”

5.2.12.3 Environmental Effects on Accidents

Mitigation measures will be in place to minimize the impact of a potential accidental release of radiological and/or nonradiological effluents. Accidental releases and mitigations are discussed in the Integrated Safety Analysis or the Emergency Response Plan. Some mitigation measures are as follows:

- The facility incorporates “state of the art” technology for handling AHF. AHF is stored in 3,630-kg (8,000-lb) storage vessels to limit inventory should a leak occur.
- AHF storage vessels are located in a building with containment-type capabilities.
- IIFP has a process safety program relating to hazardous materials as defined in OSHA 1910.119.
- IIFP has an Emergency Response Plan to address response issues.
- Wherever possible, IIFP will operate some process systems at below atmospheric pressure to prevent leaks to the atmosphere.
- DUF₆ process systems are monitored by instrumentation, which will activate alarms in the control room and will either automatically shut down the plant to a safe condition or alert operators to take the appropriate actions in the event of operational problems.

Administrative controls, practices, and procedures are used to assure compliance with IIFP’s Health, Safety, and Environmental Program. The program is designed to ensure, safe storage, use and handling of chemicals and radioactive materials to minimize the potential for worker exposure.

5.2.13 Waste Management

Mitigation measures will be in place to minimize both the generation and impact of facility wastes. Solid, liquid, and gaseous effluents will be controlled in accordance with regulatory limits. Mitigation measures include:

- No on-site disposal of waste at the IIFP facility. Waste will be stored in designated areas of the plant until an administrative limit is reached. When the administrative limit is reached, the waste will then be shipped off site to an appropriate licensed disposal facility.
- Radioactive and mixed waste will be disposed of at off-site, licensed facilities.
- Hazardous wastes and mixed wastes are stored in separate designated areas in labeled approved containers.
- Every effort will be made to minimize waste generation and wastes stored on site.
- Waste management systems will include administrative procedures and practices that provide for the collection, temporary storage, processing, and disposal of categorized solid waste in accordance with regulatory requirements.
- Process stacks and dust collector stacks are monitored for HF and for radioactive contamination.
- Liquid effluent is sampled and/or monitored in liquid waste treatment systems.
- Solid waste is segregated and containerized to prevent cross-contamination.
- Solid waste is sampled and/or monitored prior to off-site treatment and disposal.

Other waste mitigation measures will include:

- Processes used to clean up wastes and effluents create their own wastes and effluent as well. Control of these process effluents is accomplished by liquid and solid waste handling systems and techniques.
- Careful applications of basic principles for waste handling are followed in systems and processes.
- Different waste types are collected in separate containers to minimize contamination of one waste type with another. Materials that can cause airborne contamination are carefully packaged; ventilation and filtration of the air in the area are provided as necessary. Liquid wastes are confined to piping, tanks, and other containers. Curbing, pits, and sumps are used to collect and contain leaks and spills.
- Hazardous wastes are stored in designated areas in properly labeled approved containers. Mixed wastes are also contained and stored separately.
- Strong acids and caustics are neutralized before entering an effluent stream.
- Waste management systems will include administrative procedures and practices that provide for the collection, temporary storage, processing, and disposal of categorized solid waste in accordance with regulatory requirements.
- Solid wastes are sampled and/or monitored prior to off-site treatment and disposal.
- Process system samples are returned to their source, where feasible, to minimize input to waste streams.

IIFP will implement a spill control program for accidental oil spills. A Spill Prevention Control and Countermeasure (SPCC) Plan will be prepared prior to the start of operation of the facility or prior to the storage of oil on site in excess of de minimis quantities and will contain the following information:

- Identification of potential significant sources of spills and a prediction of the direction and quantity of flow that would result from a spill from each source.
- Identification of the use of containment-type or diversionary structures such as dikes, berms, culverts, booms, sumps, and diversion basins used at the facility to prevent discharged oil from reaching the surrounding environment.
- Procedures for inspection of potential sources of spills and spill containment/diversion structures.
- Assigned responsibilities for implementing the plan, inspections, and reporting.
- As part of the SPCC Plan, other measures will include control of drainage of rain water from dike areas, containment of oil and diesel fuel in bulk storage tanks, above-ground tank integrity testing, and oil and diesel fuel transfer operational safeguards.

6 ENVIRONMENTAL MEASUREMENTS AND MONITORING PROGRAMS

6.1 Radiological Monitoring

The following are the proposed sampling and monitoring locations for gaseous effluents, liquid effluents and groundwater. Exact locations will be determined at a later date based on site information.

- Eight thermoluminescent dosimeters along the perimeter fence in the north, south, east and west.
- Four soil-sampling and vegetation-sampling locations along the site perimeter fence (north, south, east, and west) and one at a location some distance away to be determined.
- Two water/sediment-sampling locations:
 - The site stormwater retention (evaporation) basin
 - The Full DUF₆ Cylinder Storage Pad Stormwater Retention Basin
- Six continuous airborne-particulate locations:
 - One on each side of the facility
 - One at the nearest resident
 - One some distance to be determined
- Four groundwater monitoring wells:
 - Background well located on the up-gradient side of the plant
 - One well located on the southeast side of the near the Full DUF₆ Cylinder Storage Pad
 - Two wells located down gradient to the plant
- Stack Sampling
 - Process stacks
 - Dust Collector Stacks
- DUF₆ to DUF₄ building air vents

6.1.1 Effluent Monitoring Program

The Nuclear Regulatory Commission (NRC) requires, pursuant to 10 CFR 20 that licensees conduct surveys necessary to demonstrate compliance with these regulations and to demonstrate that the amount of radioactive material present in effluent from the facility has been kept as low as reasonably achievable (ALARA). In addition, the NRC requires pursuant to 10 CFR 70, that licensees submit semiannual reports, specifying the quantities of the principal radionuclides released to unrestricted areas and other information needed to estimate the annual radiation dose to the public from effluent discharges. The NRC has also issued Regulatory Guide 4.15–“Quality Assurance for Radiological Monitoring Programs (Normal Operations)–Effluent Streams and the Environment” and Regulatory Guide 4.16–“Monitoring and Reporting Radioactivity in Releases of Radioactive Materials in Liquid and Gaseous Effluent from Nuclear Fuel Processing and Fabrication Plants and Uranium Hexafluoride Production Plants.” These guides reiterate that concentrations of hazardous materials in effluent must be controlled and that licensees must adhere to the ALARA principal such that there is no undue risk to the public health and safety at or beyond the site boundary.

Effluent Release Points and Meteorological Tower are shown on the plot plan, “Modified Site Features with Sampling Stations and Monitoring Locations” (Figure 6-1). For gaseous effluents, continuous air sampler filters are analyzed for gross alpha and beta each week. The filters are composited quarterly and an isotopic analysis is performed. Process liquid effluents will be stored in large tanks as appropriate.

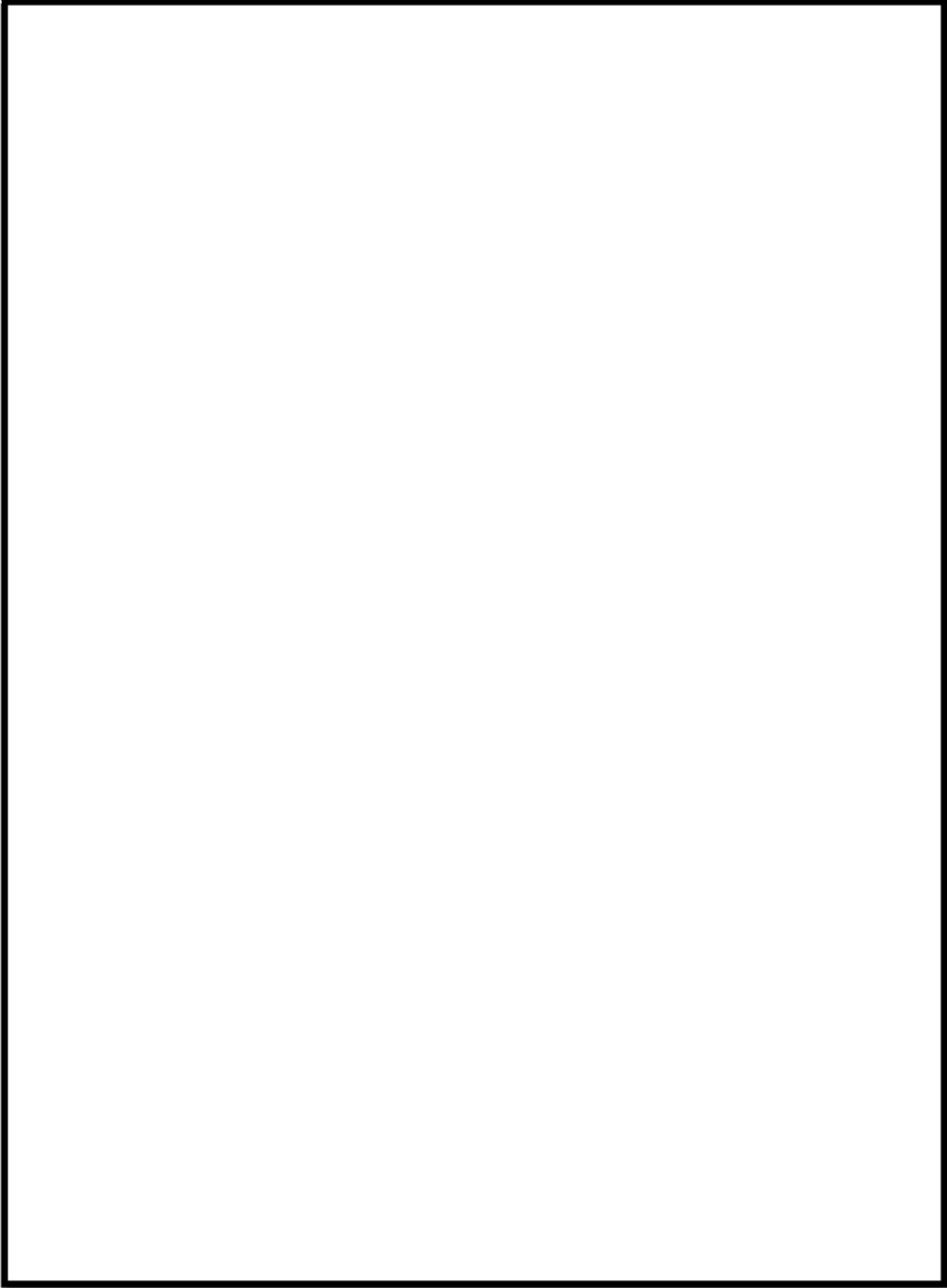

Figure 6- 1 ~~Modified Site Features with Sampling Stations and Monitoring Locations.~~ Redacted Security Related Information

Public exposure to radiation from routine operations at the International Isotopes Fluorine Products (IIFP) facility may occur as the result of discharge of liquid and gaseous effluents, including controlled releases from the uranium de-conversion process lines during decontamination and maintenance of equipment. In addition, radiation exposure to the public may result from the transportation and storage of depleted uranium hexafluoride (UF₆) feed cylinders. Of these potential pathways (detail in section 4.12.2.1), discharge of gaseous effluent has the highest potential of introducing uranium into the environment. The plant's procedures and facilities for solid waste and liquid handling, storage and monitoring result in safe storage and timely disposition of the material.

Compliance with 10 CFR 20.1301 is demonstrated using a calculation of the total effective dose equivalent (TEDE) to the individual who is likely to receive the highest dose in accordance with 10 CFR 20.1302(b)(1). The determination of the TEDE by pathway analysis is supported by appropriate models, codes, and assumptions that accurately represent the facility, site, and the surrounding area. The assumptions are reasonably conservative, input data is accurate, and applicable pathways are considered.

The computer codes used to calculate dose associated with potential gaseous and liquid effluent from the plant follow the methodology, for pathway modeling, as described in Regulatory Guide 1.109, and have undergone validation and verification. The dose conversion factors used are those presented in Federal Guidance Reports Numbers 11 and 12.

Administrative action levels are established for effluent samples and monitoring instrumentation as an additional step in the effluent control process. Action levels are sufficiently low so as to permit implementation of corrective actions before regulatory limits are exceeded. Effluent samples that exceed the action level are cause for an investigation into the source of elevated radioactivity. Radiological analyses will be performed more frequently on ventilation air filters if there is a significant increase in gross radioactivity or when a process change or other circumstances cause significant changes in radioactivity concentrations. Additional corrective actions will be implemented based on the level, automatic shutdown programming, and operating procedures to be developed in the detailed alarm design. Under routine operating conditions, radioactive material in effluent discharged from the facility complies with regulatory release criteria.

Compliance is demonstrated through effluent and environmental sampling data. If an accidental release of uranium should occur, then routine operational effluent data and environmental data will be used to assess the extent of the release. Processes are designed to include, when practical, provision for automatic shutdown in the event action levels are exceeded. Appropriate action levels and actions to be taken are specified for liquid effluents and gaseous releases. Data analysis methods and criteria used in evaluating and reporting environmental samples results are appropriate and will indicate when an action level is being approached in time to take corrective actions.

The effluent monitoring program falls under the oversight of the IIFP Radiation Safety Program. It is subject to periodic audits conducted by the facility Quality Assurance (QA) personnel. Written procedures will be in place to ensure the collection of representative samples, use of appropriate sampling methods and equipment, proper locations for sampling points, and proper handling, storage, transport, and analyses of effluent samples. In addition, the plant's written procedures also ensure that sampling and measuring equipment, including ancillary equipment such as airflow meters, are properly maintained and calibrated at regular intervals. Moreover, the effluent monitoring program procedures include functional testing and routine checks to demonstrate that monitoring and measuring instruments are in working condition. Employees involved in implementation of this program are trained in the program procedures.

IIFP will ensure that isokinetic sampling conditions are maintained in instances where pitot probes are used to sample for particulates within ducts with moving air streams. IIFP will ensure that sampling equipment (pumps, pressure gages and air flow calibrators) are calibrated by qualified individuals. Air flow and pressure drop calibration devices (e.g., rotometers) will be calibrated periodically using primary or secondary air flow calibrators (wet test meters, dry gas meters or displacement bellows). Secondary air flow calibrators will be calibrated annually by the manufacturer(s) or qualified source. Air sampling train flow rates will be verified and/or calibrated with tertiary air flow calibrators (rotometers) each time a filter is replaced or a sampling train component is replaced or modified. Sampling equipment and lines will be inspected for defects, obstructions and cleanliness. Calibration intervals of sampling equipment will be developed based on manufacturer's recommendations and nuclear industry operating experience.

6.1.1.1 Gaseous Effluent Monitoring

As a matter of compliance with regulatory requirements, potentially radioactive effluent from the facility is discharged only through monitored pathways. The effluent sampling program for the IIFP facility is designed to determine the quantities and concentrations of radionuclides discharged to the environment. The uranium isotopes and daughter products are expected to be the prominent radionuclides in the gaseous effluent. Effluents are sampled as shown in Table 6-1 "Effluent Sampling Program."

Representative samples are collected from each release point of the facility. Because uranium in gaseous effluent may exist in a variety of compounds (e.g., UF₆, uranium oxide, UF₄, and uranyl fluoride), effluent data will be maintained, reviewed, and assessed by the facility's Radiation Protection Manager, to assure that gaseous effluent discharges comply with regulatory release criteria for uranium. The gaseous effluent monitoring program for the IIFP plant is designed to determine the quantities and concentrations of gaseous discharges to the environment. The process exhaust stacks are equipped with monitors for particulate and HF.

Table 6- 1 Gaseous Effluent Sampling Program

Area	Type Sample	Type of Analysis	Frequency
Dust Collector Stacks	Continuous Air Filter	Gross Alpha/Beta Isotopic	Weekly/Composite Quarterly
Process Stacks	Continuous Air Filter	Gross Alpha/Beta Isotopic/Fluoride	Weekly/Composite Quarterly
Air Vents	Continuous Air Filter	Gross Alpha/Beta Isotopic	Weekly/Composite Quarterly

Monitoring for uranium is continuously performed between each of the bag house units, and samples are analyzed at least once per operating shift. If an unacceptable level of uranium carryover is detected on any given bag-house unit, the unit is removed from on-stream service, investigated and corrective action taken, accordingly. Additionally, each bag house is continuously monitored for differential pressure across the filter bag sections to ensure bag design integrity is maintained.

The gaseous effluent sampling program supports the determination of quantity and concentration of radionuclides discharged from the facility and supports the collection of other information required in reports to be submitted to the NRC. A minimum detectable concentration (MDC) of at least 3.7×10^{-11} Bq/ml (1.0×10^{-15} μ Ci/ml) is a program requirement for all gross alpha analyses performed on gaseous effluent samples (LES, 2005).

6.1.1.2 Liquid Effluent Monitoring

Liquid effluents containing low concentrations of radioactive material, consisting mainly of spent decontamination solutions, floor washings, liquid from the laundry, and flushes, are expected to be generated by IIFP. Uranium is the only radioactive material expected in these wastes. Potentially contaminated liquid effluent is routed to the Decontamination Area for treatment. Most of the radioactive material is removed from waste water in the Decontamination Area through a combination of clean-up processes that includes precipitation, filtration, and ion exchange. Post-treatment liquid waste water is sampled and undergoes analysis prior to disposal. Concentrated radioactive solids generated by the liquid treatment processes at the facility are handled and disposed of as low-level radioactive waste.

There is no off-site release of liquid effluents to unrestricted areas.

Representative sampling is required for all batch liquid effluent releases. Liquid samples are collected from each liquid batch and analyzed prior to any transfer. The liquid effluent sampling program supports the determination of quantities and concentrations of radionuclides and supports the collection of other information required in reports submitted to the NRC.

Periodic sampling of liquid effluent is required since these effluents are treated in batches. Representative sampling is assured through the use of tank agitators and recirculation lines. Collection tanks are sampled before the contents are sent through any treatment process. Treated water is collected in tanks, which are sampled before transfer for disposal.

NRC Information Notice 94-07 describes the method for determining solubility of discharged radioactive materials. Note that liquid effluents at the IIFP plant are treated such that insoluble uranium is removed as part of the treatment process. Releases are in accordance with the ALARA principle.

General site stormwater runoff is routed to the Site Stormwater Retention Basin.

6.1.2 Radiological Environmental Monitoring Program

The Radiological Environmental Monitoring Program (REMP) at the IIFP facility is a major part of the effluent compliance program. It provides a supplementary check of containment and effluent controls, establishes a process for collecting data for assessing radiological impacts on the environs and estimating the potential impacts on the public, and supports the demonstration of compliance with applicable radiation protection standards and guidelines.

6.1.2.1 Sampling Program

The primary objective of the REMP is to provide verification that the operations at the facility do not result in detrimental radiological impacts on the environment. Through its implementation, the REMP provides data to confirm the effectiveness of effluent controls and the effluent monitoring program. In order to meet program objectives, representative samples from various environmental media are collected and analyzed for the presence of plant-related radioactivity. The types and frequency of sampling and analyses are summarized in Table 6-2. Environmental media identified for sampling consist of ambient air, groundwater, soil/sediment, and vegetation. Environmental samples will be analyzed on site.

Table 6- 2 Radiological Sampling and Analysis Program

Sample Type	Location	Sampling and Collection Frequency	Type of Analysis
Continuous Airborne particulate	Six locations along fence line and in the region of influence including the nearest resident.	Continuous operation of air sampler with sample collection as required by dust loading but at least biweekly. Quarterly composite samples by location.	Gross beta/gross alpha analyses each filter change. Quarterly isotopic analysis on composite sample.
Vegetation/Soil Analyses	Five-Four locations along fence line and a control some distance away	For each vegetation and soil sample, 1 to 2 kilograms (2.2 to 4.4 pounds). Quarterly pre-operation/semi-annual during operations.	Isotopic analyses/fluoride
Groundwater	Four wells.	Samples [4 liters (1.1 gallons)] collected semiannually.	Isotopic analyses
Thermo-luminescent Dosimeters	Eight locations along fence line.	Samples collected quarterly	Gamma and neutron equivalent
Stormwater	Site Stormwater Retention Basin DUF ₆ Cylinder Storage Pads, Stormwater Retention Basins	Water Sample 4 liters (1.1 gallons) Sediment samples 1 to 2 kilograms (2.2 to 4.4 pounds)	Isotopic analyses

However, samples may also be shipped to a qualified independent laboratory for analyses. Monitoring and sampling activities, laboratory analyses, and reporting of facility-related radioactivity in the environment will be conducted in accordance with industry-accepted and regulatory-approved methodologies.

The REMP includes the collection of data during pre-operational years in order to establish baseline radiological information that will be used in determining and evaluating impacts from operations at the plant on the local environment. The REMP will be initiated at least 12 months prior to plant operations in order to develop a sufficient database. The early initiation of the REMP provides assurance that a sufficient environmental baseline has been established for the plant before the arrival of the first uranium hexafluoride shipment. Radionuclides in environmental media will be identified using technically appropriate, accurate, and sensitive analytical instruments. Data collected during the operational years will be compared to the baseline generated by the pre-operational data. Such comparisons provide a means of assessing the magnitude of potential radiological impacts on members of the public and in demonstrating compliance with applicable radiation protection standards.

During the course of facility operations, revisions to the REMP may be necessary and appropriate to assure reliable sampling and collection of environmental data. The rationale and actions behind such revisions to the program will be documented and reported to the appropriate regulatory agency, as required. REMP sampling focuses on locations within 1 mile of the facility, but may also include distant locations as control sites. The sampling locations may be subject to change as determined from the results of periodic review of land use.

Atmospheric radioactivity monitoring is based on plant design data, demographic and geologic data, meteorological data, and land use data. Because operational releases are anticipated to be very low and subject to rapid dilution via dispersion, distinguishing plant-related radiation from background radiation already present in the site environment is a major challenge of the REMP. The gaseous effluent is released from roof-top discharge points, or resuspension of particles from the Retention Basins, which will result in ground-level releases. A characteristic of ground-level plumes is that plume concentrations decrease continually as the distance from the release point increases. It logically follows that the impact at locations close to the release point is greater than at more distant locations. The concentrations of radioactive material in gaseous effluent from the IIFP plant are expected to be very low concentrations of uranium because of process and effluent controls. Consequently, air samples collected at locations that are close to the plant would provide the best opportunity to detect and identify plant-related radioactivity in the ambient air. Therefore, air-monitoring activities will concentrate on collection of data from locations that are relatively close to the plant, such as the plant perimeter fence or the plant property line. Air monitoring stations will be situated along the fence perimeter, nearest resident, and “control comparative” locations. In addition, an air monitoring station will be located next to the Stormwater Retention Basins in order to measure for particulate radioactivity that may be resuspended into the air from sediment layers when the basin is dry.

A control sample location will be established beyond 8 km (5 mi) in an upwind sector (the sector with least prevalent wind direction). Environmental air samplers operate on a continuous basis with sample retrieval for a gross alpha and beta analysis occurring on a weekly basis (or as required by dust loads).

Vegetation and soil samples, both from on and off-site locations will be collected on a quarterly basis in each sector during the pre-operational REMP. This is to assure the development of a sound baseline. During the operational years, vegetation and soil sampling will be performed semiannually in five sectors, including three with the highest predicted atmospheric deposition. Vegetation samples may include vegetables and grass, depending on availability. Soil samples will be collected in the same vicinity as the vegetation samples.

Groundwater samples from on-site monitoring well(s) will be collected semiannually for radiological analysis. Two monitoring wells will be located down-gradient of the site, one will be located down-gradient of the DUF₆ Cylinder Storage Pads and one will be located up-gradient (background monitoring well) of the site facilities.

Any other sites or facilities with contaminants of concern should be differentiated from potential contaminants from the IIFP plant.

Sediment samples will be collected semiannually from the stormwater runoff retention basins on site to look for any buildup of uranic material being deposited.

Sanitary treatment biomass will be disposed at an approved disposal site.

Direct radiation in off-site areas from processes inside the facility building is expected to be minimal because the low-energy radiation associated with the uranium will be shielded by the process piping, equipment, and cylinders to be used at the IIFP facility.

Because the off-site dose equivalent rate from stored DUF₆ cylinders is expected to be very low and difficult to distinguish from the variance in normal background radiation beyond the site boundary, demonstration of compliance will rely on a system that combines direct dose equivalent measurements and computer modeling to extrapolate the measurements. Environmental thermoluminescent dosimeters

(TLDs) placed at the plant perimeter fence line or other location(s) close to the DUF₆ cylinders will provide quarterly direct dose equivalent information. The direct dose equivalent at off-site locations will be estimated through extrapolation of the quarterly TLD data using computer programs. Refer to Figure 6-1, "Modified Site Features With Proposed Sampling Stations and Monitoring Stations." Figure 6-1 shows the location of REMP sampling locations.

6.1.2.2 Procedures

The Quality Control (QC) procedures used by the laboratories performing the plant's REMP will be adequate to validate the analytical results and will conform to the guidance in Regulatory Guide 4.15. These QC procedures include the use of established standards such as those provided by the National Institute of Standards and Technology (NIST), as well as standard analytical procedures such as those established by the National Environmental Laboratory Accreditation Conference (NELAC).

Monitoring procedures will employ well-known acceptable analytical methods and instrumentation. The instrument maintenance and calibration program will be appropriate to the given instrumentation, in accordance with manufacturers' recommendations.

IIFP will ensure that the on-site laboratory and any contractor laboratory used to analyze IIFP samples participates in third-party laboratory intercomparison programs appropriate to the media and analytes being measured. IIFP will require that all radiological and non-radiological laboratory vendors are certified by the National Environmental Laboratory Accreditation Program (NELAP) or an equivalent state laboratory accreditation agency for the analytes being tested.

The REMP falls under the oversight of the facility's Quality Assurance (QA) program. Therefore, written procedures to ensure representative sampling, proper use of appropriate sampling methods and equipment, proper locations for sampling points, and proper handling, storage, transport, and analyses of effluent samples will be a key part of the program. In addition, written procedures ensure that sampling and measuring equipment, including ancillary equipment such as airflow meters, are properly maintained and calibrated at regular intervals. Moreover, the REMP implementing procedures will include functional testing and routine checks to demonstrate that monitoring and measuring instruments are in working condition.

The design status of leak detection (and mitigation procedures) for basins and tanks has not yet progressed to final design. IIFP will conform to leak detection recommendations required in NUREG-1520.

6.1.2.3 Reporting

Reporting procedures will comply with the requirements of 10 CFR 70.59 and the guidance specified in Regulatory Guide 4.16. Reports of the concentrations of principal radionuclides released to unrestricted areas in effluents will be provided and will include the Minimum Detectable Concentration (MDC) for the analysis and the error for each data point.

Each year, IIFP will submit a summary report of the environmental sampling program to the NRC, including all associated data as required by 10 CFR 70. The report will include the types, numbers, and frequencies of environmental measurements and the identities and activity concentrations of facility-related nuclides found in environmental samples, in addition to the MDC for the analyses and the error associated with each data point. Significant positive trends in activities will also be noted in the report, along with any adjustment to the program, unavailable samples, and deviations to the sampling program.

6.2 Physiochemical Monitoring

6.2.1 Introduction

The primary objective of physiochemical monitoring is to provide verification that the operations at the IIFP plant do not result in detrimental chemical impacts on the environment. Effluent controls are in place to assure that chemical concentrations in gaseous and liquid effluents are maintained as low as reasonably achievable (ALARA). In addition, physiochemical monitoring provides data to confirm the effectiveness of effluent controls.

Administrative action levels will be implemented prior to facility operation to ensure that chemical discharges will remain below the limits specified in the facility discharge permits. The limits are specified in the EPA Region 6 National Pollutant Discharge Elimination System (NPDES) General Discharge Permits as well as the New Mexico Water Quality Bureau (NMWQB) Groundwater Discharge Permit/Plan.

In conducting physiochemical monitoring, sampling protocols and emission/effluent monitoring will be performed for routine operations with provisions for additional evaluation in response to potential accidental release.

The facility will have an Environmental Monitoring Laboratory, which will be equipped with analytical instruments needed to ensure that the operation of the plant activities complies with federal, state and local environmental regulations and requirements. Compliance will be demonstrated by monitoring/sampling at various plant and process locations, analyzing the samples and reporting the results of these analyses to the appropriate agencies. The sampling/monitoring locations will be selected by the Health, Safety and Environmental (HS&E) organization staff in accordance with facility permits and good sampling practices.

The Environmental Monitoring Laboratory will be available to perform analyses on air, water, soil, flora, and fauna samples obtained from designated areas around the plant. In addition to its environmental and radiological capabilities, the Environmental Monitoring Laboratory is also capable of performing bioassay analyses when necessary. Commercial, off-site laboratories may also be contracted to perform bioassay analyses.

Waste liquids, solids and gases from related processes and decontamination operations will be analyzed and/or monitored for chemical and radiological contamination to determine safe disposal methods and/or further treatment requirements.

6.2.2 Evaluation and Analysis of Samples

Samples of liquid effluents, solids and gaseous effluents from plant processes will be analyzed in the Environmental Monitoring Laboratory. Results of process samples analyses are used to verify that process parameters are operating within expected performance ranges. Results of liquid effluent sample analyses will be characterized to determine if treatment is required prior to discharge or disposal.

6.2.3 Effluent Monitoring

Chemical constituents that may be discharged to the environment in facility effluents will be below concentrations that have been established by state and federal regulatory agencies as protective of the public health and the natural environment. Under routine operating conditions, no significant quantities of

contaminants will be released from the facility. This will be confirmed through monitoring and collection and analysis of environmental data. The facility does not directly discharge any industrial effluents to surface waters or grounds off-site, and there is no plant tie-in to a Publicly Owned Treatment Works (POTW). Except for discharges from the Sanitary Treatment System, liquid effluents are contained on the IIFP site via collection tanks and retention basins.

Parameters for continuing environmental performance will be developed from the baseline data collected during preoperational sampling. Operational monitoring surveys will also be conducted using sampling sites and at frequencies established from baseline sampling data and as determined based on requirements. Operational monitoring surveys are determined based on requirements contained in EPA Region 6 NPDES General Discharge Permits as well as the NMWQB Groundwater Discharge Permit/Plan.

The frequency of some types of samples may be modified depending on baseline data for the parameters of concern. As construction and operation phases of the de-conversion plant proceed, changing conditions (e.g., regulations, site characteristics, and technology) and new knowledge may require that the monitoring program be reviewed and updated. The monitoring program will be enhanced as appropriate to maintain the collection and reliability of environmental data. The specific location of monitoring points will be determined in detailed design.

During implementation of the monitoring program, some samples may be collected in a different manner/method than specified herein. Examples of reasons for these deviations include severe weather events, changes in the length of the growing season, and changes in the number of plantings. Under these circumstances, documentation shall be prepared to describe how the samples were collected and the rationale for any deviations from normal monitoring program methods. If a sampling location has frequent unavailable samples or deviations from the schedule, then another location may be selected or other appropriate actions taken.

Each year, IIFP will submit a summary of the environmental sampling program and associated data to the proper regulatory authorities, as required. This summary will include the types, numbers and frequencies of samples collected.

Physiochemical monitoring will be conducted via sampling of stormwater, soil, sediment, vegetation, and groundwater as defined in Table 6-3, to confirm that trace, incidental chemical discharges are below regulatory limits. There are no surface waters on the site; therefore, no Surface Water Monitoring Program will be implemented. However soil sampling will include outfall/overflow areas such as the outfall at the Site Stormwater Retention Basins. In the event of any accidental release from the facility, these sampling protocols will be initiated immediately and on a continuing basis to document the extent/impact of the release until conditions have been abated and mitigated.

No chemical sampling is planned for sanitary wastes because no plant process related effluents will be introduced.

6.2.4 Stormwater Monitoring Program

A stormwater monitoring program will be initiated during construction phases of the facility. Data collected from the program will be used to evaluate the effectiveness of measures taken to prevent the contamination of stormwater and to retain sediments within property boundaries. A temporary detention basin will be used as a sediment control basin during construction phases as part of the overall sedimentation erosion control plan.

Table 6- 3 Physiochemical Sampling

Sample Type	Sample Location	Frequency	Sampling and Collections ²
Stormwater	Stormwater Detention Basins	Quarterly	Analytes as determined by baseline program
Vegetation	5 minimum ¹	Quarterly/ Semiannually ³	Fluoride Uptake (growing seasons)
Soil	5 minimum ¹	Quarterly/ Semiannually ³	Metals, Organics, Pesticides, and Fluoride Uptake
Water/Sediment	2 minimum ¹	Quarterly/ Semiannually ³	Analytes as determined by baseline program
Groundwater	Selected Groundwater Wells	Semiannually	Metals, Organics and Pesticides

¹ Location to be established by Health, Safety and Environmental (HS&E) organization staff.

² Analyses will meet EPA Lower Limits of Detection (LLD), as applicable, and will be based on the baseline surveys and the type of matrix (sample type).

³ Quarterly in Pre-operations/Semi-annual during operations.

Stormwater monitoring will continue with the same monitoring frequency upon initiation of facility operation. During plant operation, samples will be collected from the DUF₆ Cylinders Storage Pad Stormwater Retention Basin and the Site Stormwater Detention Basin in order to demonstrate that runoff does not contain contaminants. A list of parameters to be monitored and monitoring frequencies is presented in Table 6-3.

Table 6-4 shows the parameters to be monitored with respect to stormwater. This monitoring program

Table 6- 4 Stormwater Monitoring Program

Analyte	Frequency	Sampling Method	Lower Limit of Detection
Oil & Grease	Quarterly	If standing water exists, Grab	0.5 ppm
Total Suspended Solids (TSD)	Quarterly	If standing water exists, Grab	0.5 ppm
5-Day Biological Oxygen Demand (BOD)	Quarterly	If standing water exists, Grab	2 ppm
Chemical Oxygen Demand (COD)	Quarterly	If standing water exists, Grab	1 ppm
Total Phosphorus	Quarterly	If standing water exists, Grab	0.1 ppm
Total Kjeldahl Nitrogen	Quarterly	If standing water exists, Grab	0.1 ppm
pH	Quarterly	If standing water exists, Grab	0.01 units
Nitrate plus Nitrite Nitrogen	Quarterly	If standing water exists, Grab	0.2 ppm
Metals	Quarterly	If standing water exists, Grab	Varies ¹

¹ Analyses will meet EPA Lower Limits of Detection (LLD), as applicable, and will be based on the baseline surveys and the type of matrix (sample type).

Source: LES, 2005

will be refined to reflect applicable requirements as determined during the NPDES process. Additionally, the Site Stormwater Retention Basin will adhere to the requirements of the Groundwater Discharge Permit/Plan from the NMWQB

6.2.5 Environmental Monitoring

The purpose of this section is to describe the surveillance-monitoring program, which will be implemented to measure non-radiological chemical impacts upon the natural environment. The ability to detect and contain any potentially adverse chemical releases from the facility to the environment will depend on chemistry data to be collected as part of the effluent and stormwater monitoring programs described in the preceding sections. Data acquisition from these programs encompasses both on-site and off-site sample collection locations and chemical element/compound analyses. Final constituent analysis requirements will be in accordance with permit mandates.

Sampling locations will be determined based on meteorological information and current land use. The sampling locations may be subject to change as determined from the results of any observed changes in land use.

The range of chemical surveillance incorporated into the planned effluent monitoring programs for the facility is designed to be sufficient to predict any relevant chemical interactions in the environment related to plant operations.

Vegetation samples will include grasses and shrub brush. Soil will be collected in the same vicinity as the vegetation sample. The samples are collected from both on-site and off-site locations in various sectors. Sectors are chosen based on air modeling. Sediment samples will be collected from discharge points to the different collection basins on site. At this time, groundwater samples will be collected from a series of wells that will be installed around the plant. The locations of the groundwater sampling (monitoring) wells are as described in Section 6.1.2 and are shown in Figure 6-1.

Stormwater samples collected in the DUF₆ Cylinder Storage Pad Stormwater Retention Basin will be sampled to ensure no contaminants are present.

6.2.6 Meteorological Monitoring

In order to monitor and characterize meteorological phenomena (e.g., wind speed, direction, and temperature) during plant operation as well as consider interaction of meteorology and local terrain, conditions will be monitored with a 40-m (132-ft) tower located on site. This data will assist in evaluating the potential locales on and off property that could be influenced by any emissions. The instrument tower will be located at a site approximately the same elevation as the finished facility grade and in an area where facility structures will have little or no influence on the meteorological measurements. An area approximately ten times the obstruction height around the tower towards the prevailing wind direction will be maintained in accordance with established standards for meteorological measurements. This practice will be used to avoid spurious measurements resulting from local building-caused turbulence. The program for instrument maintenance and servicing, combined with redundant data recorders, assures at least 90% data recovery.

The data this equipment provides is recorded and can be used for dispersion calculations. Equipment will also measure temperature and humidity, which will be recorded as well.

6.2.7 Biota

The monitoring of radiological and physiochemical impacts to biota are detailed in Section 6.3, “Ecological Monitoring” of this report.

6.2.8 Quality Assurance

Quality assurance will be achieved by following a set of formalized and controlled procedures that IIFP will create, implement and periodically review for sample collection, lab analysis, chain of custody, reporting of results, and corrective actions. Corrective actions will be instituted when an action level is exceeded for any of the measured parameters. Action levels will be divided into three priorities: 1) if the sample parameter is three times the normal background level; 2) if the sample parameter exceeds any existing administrative limits, or; 3) if the sample parameter exceeds any regulatory limit. The third scenario represents the worst case, which is not expected. Corrective actions will be implemented to ensure that the cause for the action level exceedance can be identified and immediately corrected, applicable regulatory agencies are notified, if required, communications to address lessons learned are dispersed to appropriate personnel, and applicable procedures are revised accordingly if needed. Action plans will be commensurate to the severity of the exceedance.

IIFP will ensure that the on-site laboratory and any contractor laboratory used to analyze IIFP samples participates in third-party laboratory intercomparison programs appropriate to the media and analytes being measured. Examples of these third-party programs are the Mixed Analyte Performance Evaluation Program (MAPEP) and the DOE Quality Assurance Program (DOEQAP) that are administered by the Department of Energy. The IIFP facility will require all radiological and non-radiological laboratory vendors to be certified by the National Environmental Laboratory Accreditation Conference (NELAC) or an equivalent state laboratory accreditation agency for the analytes being tested.

6.2.9 Lower Limits of Detection

Lower limits of detection for the parameters sampled for in the Stormwater Monitoring Program are listed in Table 6-4, “Stormwater Monitoring Program.” Lower limits of detection (LLD) for the nonradiological parameters shown in Table 6-3, “Physiochemical Sampling,” will be based on the results of the baseline surveys and the type of matrix (sample type). Those required minimum detectable concentrations for environmental sample analyses are listed in Table 6-5.

Table 6- 5 Required Minimum Detectable Concentrations for Environmental Sample Analyses

Medium	Analysis	Minimum Detectable Concentrations Bq/ml (μ Ci/ml) ¹
Ambient Air	Gross Alpha	3.7×10^{-14} (1.0×10^{-18})
Vegetation	Isotopic uranium	3.7×10^{-6} (1.0×10^{-10})
Soil/Sediment	Isotopic uranium	1.1×10^{-2} (3.0×10^{-7})
Groundwater	Isotopic uranium	3.7×10^{-8} (1.0×10^{-12})

¹ becquerels per milliliter (microcuries per milliliter)
Source: LES, 2005

6.3 Ecological Monitoring

6.3.1 Maps

Figure 6-1, Modified Site Features with Sampling Stations and Monitoring Locations.

Figure 6-2, Topographical Map of Area around IIFP Site at Arkansas Junction

Figure 6-3, Grasslands of National Forest Systems New Mexico, Oklahoma, and Texas.

Figure 6-4, Lesser Prairie Chicken Historic and Current Distribution

Figure 6-5, Expected Range of the Sand Dune Lizard

6.3.1 General Ecological Conditions of the Site

Figure 6-2 is a topographical map showing the features from Hobbs to the site at Arkansas Junction. Surface drainage at the site is contained within a few, intermittent local playas that have no external drainage. Since runoff does not drain to one of the state's major rivers, surface water is lost through evaporation, resulting in high salinity conditions in the water and soils associated with the playas. These conditions are not favorable for the development of viable aquatic or riparian habitats. There is also a small stream that runs from the southeast to the northwest across the property that is predominantly dry during the year.

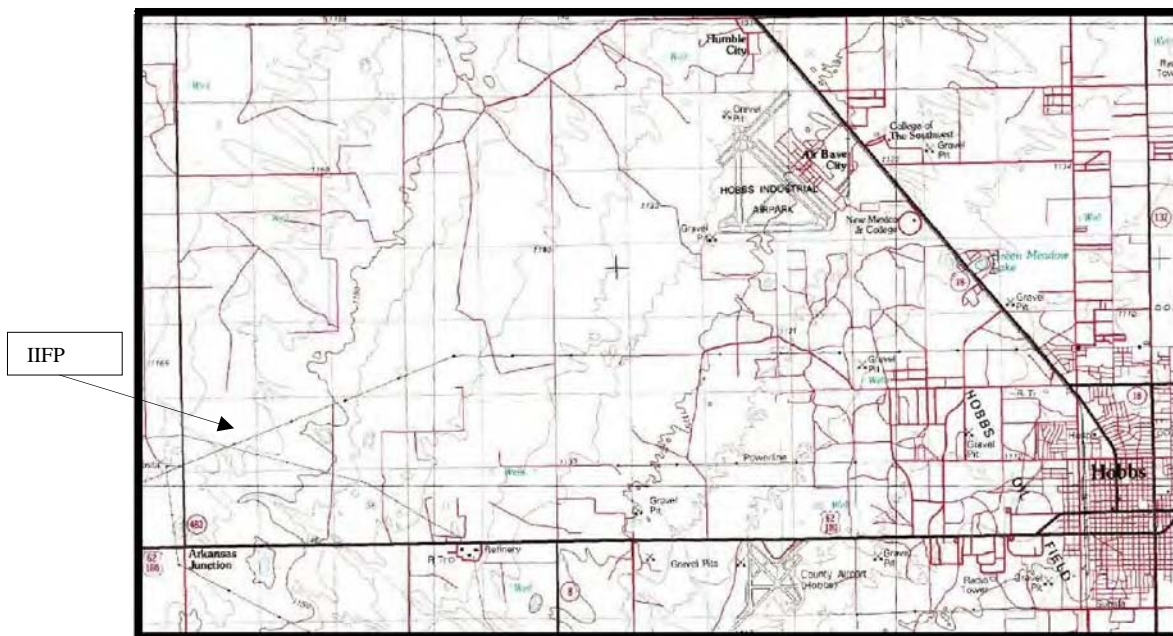
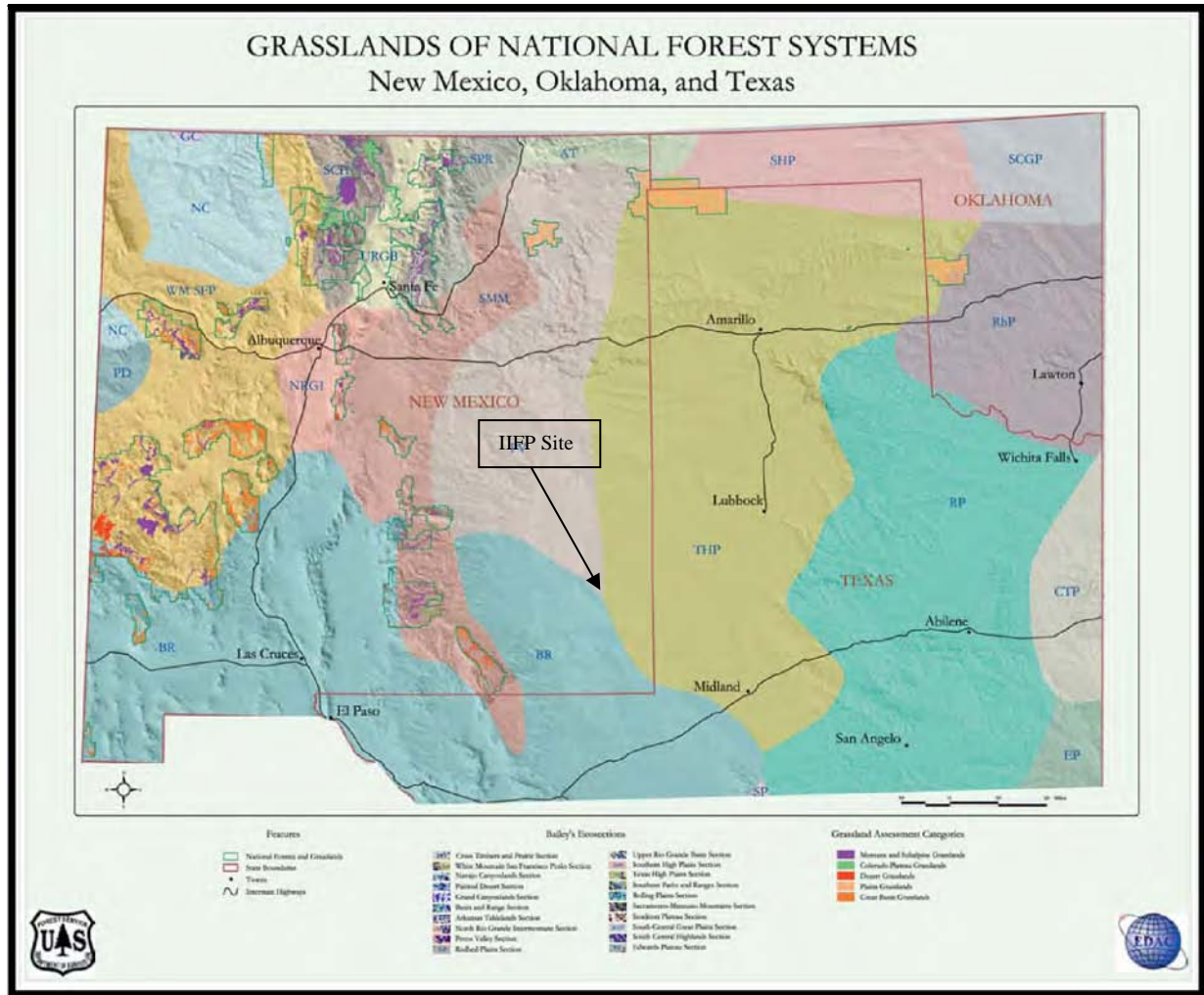

Figure 6- 2 Topographical Map of Area around IIFP Site at Arkansas Junction

Different life-form zones exist within Lea County. As with the other geography and landscape features, the life forms, both plant and wildlife, are separated by the Mescalero Ridge (Refer to Figure 3-16). Also see Figure 6-3, Grasslands around the IIFP Site, to see this distinct separation. The area is a transitional zone between the short-grass prairie of the north of the Mescalero Ridge (Southern High Plains) and the desert communities south of the Mescalero Ridge (Chihuahuan Desert Scrub).



Source: USGS, 2005

Figure 6- 3 Grasslands around the IIFP Site

The vegetation in this area is dominated by deep sand tolerant or deep sand adapted plant species. The vegetation community at the IIFP site has probably remained stable over the past 150 years since the introduction of domestic livestock grazing in the area by settlers from the eastern plains. The existing natural habitats on the IIFP site and the region surrounding the site have been impacted by domestic livestock grazing, oil/gas pipeline right-of-ways and access roads. These current and historic land uses have resulted in a dominant habitat type, the plains sand scrub. Hundreds of square kilometers (miles) of this habitat type occur in the area of the IIFP site. The habitat type at the IIFP site does not support any rare, threatened, or endangered animal or plant species. The basin and range vegetation type is characterized by shinnery oak shrub, mesquite shrub, and short to mid-grass prairie with little or no overhead cover.

6.3.3 Affected Important Ecological Resources

In the area of the IIFP site, the presence of a mesquite shrubs provide needed protective cover from raptors and the short grass prairie vegetation meets the requirements for the breeding areas known as "booming grounds" or leks. Though the IIFP site contains suitable lesser prairie chicken habitat, this type

of habitat is not uncommon in the general area. See Figure 6-4 for the map showing the historic and current distribution of the lesser prairie chicken (WildEarth Guardians, 2008).

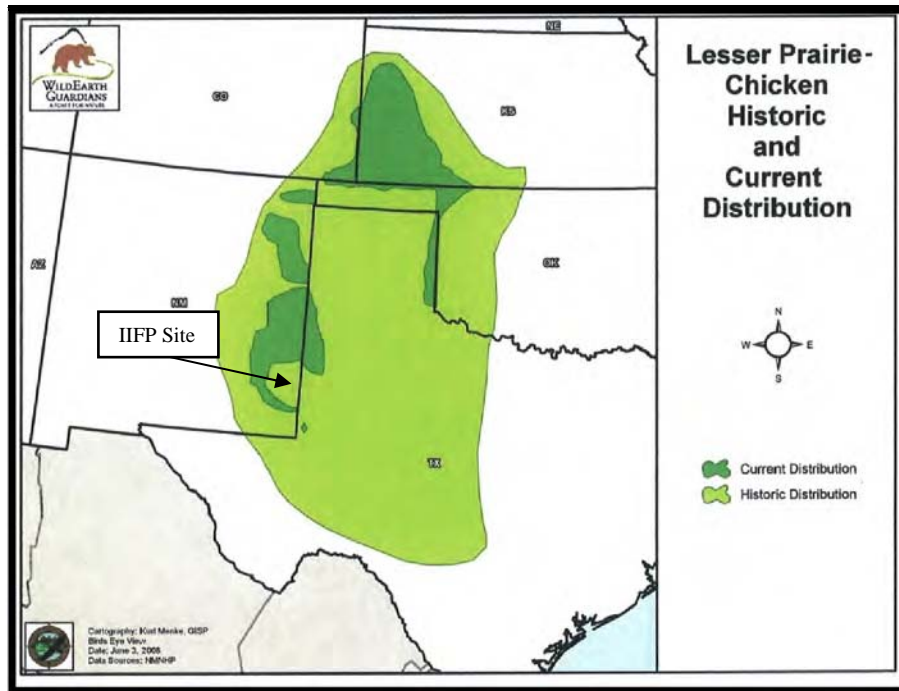

Source: WildEarth Guardians, 2008

Figure 6- 4 Lesser Prairie-Chicken Habitat around the IIFP Facility

Dunes that have become completely stable by vegetation appear to be unsuitable habitat. The sand dune lizard diet consists primarily of insects such as ants, crickets, grasshoppers, beetles, spiders, ticks and other arthropods. Most feeding appears to take place with or immediately adjacent to patches of vegetation. It is likely that the IIFP site provides an adequate food source for the sand dune lizard; however, the habitat areas likely containing the sand dune lizard starts approximated 19.3 km (12 mi) south of the IIFP site. See Figure 6-5, “Expected Range of the Sand Dune Lizard,” in Lea, Eddy, and Chaves Counties, New Mexico (Painter, 2004).

There are no known important ecological systems on site that are especially vulnerable to change or that contain important species habitats, such as breeding areas, nursery, feeding, resting, and wintering areas, or other areas of seasonally high concentrations of individuals of important species. Wildlife species on the site typically occur at average population concentrations for the basin and range habitat type.

For detail listing of Ecological Resources, see Chapter 3 Section 3.5.

6.3.4 Monitoring Program Elements

Several elements have been chosen for the ecological monitoring program. These elements include vegetation, birds, mammals, and amphibians. Currently there is no known action or reporting level for each specific element. However, additional consultation with all appropriate agencies [New Mexico Department of Game & Fish, U.S. Fish & Wildlife Service (USFWS)] will continue. Any agency

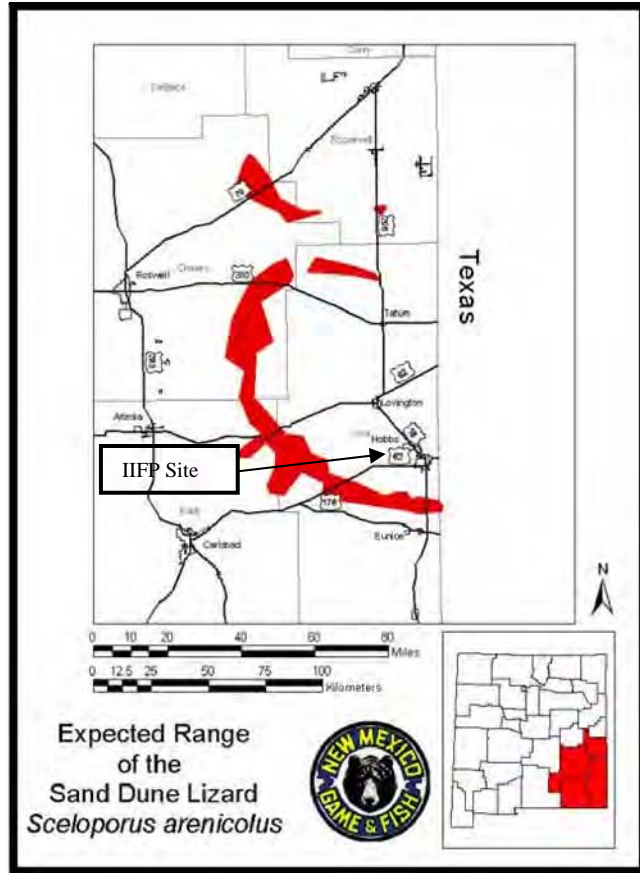

Source: Painter, 2004

Figure 6- 5 Location of Sand Dune Lizard Habitat around IIFP Site

recommendation, based on future consultation and monitoring program data, will be considered when developing action and/or reporting levels for each element.

IIFP would periodically monitor the proposed site property and waters during the construction phases and operation to ensure the risk to birds and wildlife is minimized.

6.3.5 Observations and Sampling Design

The IIFP site observations will include pre-licensing and general construction and operations monitoring programs. The pre-licensing construction monitoring program will establish the site baseline data. The procedures used to characterize the plant, bird, mammalian, and reptilian/amphibian communities at the IIFP site during pre-licensing construction monitoring are considered appropriate and will be used for both the construction and operations monitoring programs. Operational monitoring surveys will also be conducted annually (except semiannually for birds and reptilian/amphibians and mammals) using the same sampling sites established during the pre-licensing construction monitoring program.

These surveys are intended to be sufficient to characterize gross changes in the composition of the vegetative, avian, mammalian, and reptilian/amphibian communities of the site associated with operation of the plant. Interpretation of operational monitoring results, however, must consider those changes that would be expected at the IIFP site as a result of natural succession processes. Plant communities at the

site will continue to change as the site begins to regenerate and mature. Changes in the bird, small mammal, and reptile/amphibian communities are likely to occur concomitantly in response to the changing habitat.

6.3.5.1 Vegetation

The following will be considered in the vegetation sampling program; collection of ground cover, frequency, woody plant density, and production data. Sampling from sixteen permanent sampling locations within the IIFP site will occur annually in September or October. Annual sampling is scheduled to coincide with the mature flowering stage of the dominant perennial species.

The sampling locations are selected in areas outside of the proposed footprint of the IIFP facility. The selected sampling locations will be marked physically on site and the Global Positioning System (GPS) coordinates will be recorded. The expected positions of the sampling locations are plotted on a site schematic. (See Figure 6-1, Modified Site Features with Proposed Sampling Stations and Monitoring Locations.) The establishment of permanent sampling locations will facilitate a long-term monitoring system to evaluate vegetation trends and characteristics.

Transects used for data collection will originate at the sampling location and radiate out 30 m (100 ft) in a specified compass direction. Ground cover and frequency will be determined utilizing the line intercept method. Each 0.3 m (1 ft) segment is considered a discrete sampling unit. Cover measurements will be read to the nearest 0.03 m (0.1 ft). Woody plant densities will be determined using the belt transect method. All shrub and tree species rooted within 2 m (6 ft) of the 30 m (100 ft) transect will be counted. Productivity will be determined using a double sampling technique. The double sampling technique consists of estimating the production within three 0.25 m² (2.7 ft²) plots and harvesting one equal sized plot for each transect. Harvesting consists of clipping each species in a plot separately, oven drying, and weighing to the nearest 0.01 g. The weights will be converted to kg (lbs) of oven dry forage per hectare (acre).

6.3.5.2 Birds

Site-specific avian surveys will be conducted in both the wintering and breeding seasons to verify the presence of particular bird species at the IIFP site. Winter and spring surveys will be designed to identify the members of the avian community.

For the winter survey, the distinct habitats at the site will be identified and the bird species composition within each of the habitats described. Transects 100 m (328 ft) in length will be established within each distinct homogenous habitat and data will be collected along the transect. Species composition and relative abundance will be determined based on visual observations and call counts.

In addition to verifying species presence, the spring survey will be designed to determine the nesting and migratory status of the species observed and (as a measure of the nesting potential of the site) the occurrence and number of territories of singing males and/or exposed, visible posturing males. The area will be surveyed using the standard point count method. Standard point counts require a qualified observer to stand in a fixed position and record all the birds seen and heard over a time period of five minutes. Distances and time are each subdivided. Distances are divided into less than 50 m (164 ft) and greater than 50 m (164 ft) categories (estimated by the observer), and the time is divided into two categories, 0-3 minute and 3-5 minute segments. All birds seen and heard at each station/point visited will be recorded on standard point count forms. All surveys will be conducted from 0615 to 1030 hours to coincide with the territorial males' peak singing times. The stations/points will be recorded using the GPS

enabling the observer to make return visits. Surveys will only be conducted at time when fog, wind, or rain does not interfere with the observer's ability to accurately record data.

The avian communities are described in Section 3.5. All data collected will be recorded and compared to all the communities known to exist in the area. The field data collections will be done semiannually. The initial monitoring will be effective for at least the first 3 years of commercial operation. Following this period, program changes may be initiated based on operational experience.

6.3.5.3 Mammals

Annual on-site surveys will monitor the mammalian communities. The existing mammalian communities are described in Section 3.5. General observations will be compiled concurrently with other wildlife monitoring data and compared to all the communities known to exist in the area. The initial monitoring will be effective for at least the first 3 years of commercial operation. Following this period, program changes may be initiated based on operational experience.

6.3.5.4 Reptilian and Amphibians

There are several groups of reptile and amphibian species (lizards, snakes, amphibians) that provide the biological characteristics (demographics, life history characteristics, site specificity, environmental sensitivity) for an informative environmental monitoring program. Approximately 6 species of lizards, 8 species of snakes and 3 species of amphibians may occur on the site and in the area.

A combination of pitfall drift-fence trapping and walking transects (at trap sites) can provide data in sufficient quantity to allow statistical measurements of population trends, community composition, body size distributions and sex ratios that will reflect environmental conditions and changes at the site over time.

Each sample site will be designed to maximize the total catch of reptilian and amphibians, rather than data on each individual caught. Each animal caught will be identified, sexed, snout-vent length measured, inspected for morphological anomalies and released (sample with replacement design). There will be two sample periods, at the same time each year, in May and late June/early July. These coincide with breeding activity for lizards, most snakes and depending on rainfall, amphibians.

Because reptilian and amphibians are sensitive to climatic conditions, and to account for the spotty effects of rainfall, each sampling event will also record rainfall, relative humidity and temperatures. The rainfall and temperature data will act as a covariate in the analysis.

Additionally, the off-site sample locations act to balance out climatic effects on populations of small animals. The comparison of IIFP site data and off-site location data allows for monitoring to be a much more informative environmental indicator of conditions at the IIFP site.

The reptile and amphibian communities are described in Section 4.5, "Ecological Resources Impacts." In addition to the monitoring plan described above, general observations will be gathered and recorded concurrently with other wildlife monitoring. The data will be compared to all the communities known to exist in the area. The initial reptile and amphibian monitoring program will be effective for at least the first three years of commercial operation. Following this period, program changes may be initiated based on operational experience.

6.3.6 Statistical Validity of Sampling Program

The proposed sampling program will include descriptive statistics. Descriptive statistics will include the mean, standard deviation, standard error, and confidence interval for the mean. In each case the sampling size will be clearly indicated. The use of these standard descriptive statistics will be used to show the validity of the sampling program. A significance level of 5% will be used for the studies, which results in a 95% confidence level.

6.3.7 Sampling Equipment

Due to the type of ecological monitoring proposed for the IIFP plant no specific sampling equipment is necessary.

6.3.8 Method of Chemical Analysis

Due to the type of monitoring proposed for the IIFP facility, no chemical analysis is proposed for ecological monitoring.

6.3.9 Data Analysis and Reporting Procedures

IIFP or its contractor will analyze the ecological data collected on the IIFP site. The Health, Safety & Environmental (HS&E) Manager or a staff member reporting to the HS&E manager will be responsible for the data analysis.

A summary report will be prepared which will include the types, numbers and frequencies of samples collected.

6.3.10 Agency Consultation

Consultation will be initiated with all appropriate federal and state agencies and affected Native American Tribes.

6.3.11 Organization Responsible for Reviewing the Monitoring Program on an Ongoing Basis

As policy directives are developed, documentation of the environmental monitoring programs will occur. The person or organizational unit responsible for reviewing the program on an ongoing basis will be the HS&E Manager.

6.3.12 Established Criteria

The ecological monitoring program is conducted in accordance with generally accepted practices and the requirements of the New Mexico Department of Game and Fish. Data will be collected, recorded, stored and analyzed. Actions will be taken as necessary to reconcile anomalous results.

7. COST-BENEFIT ANALYSIS

This chapter describes the costs and benefits for the International Isotopes Fluorine Products (IIFP) Facility Proposed Action. The Proposed Action and Alternatives are discussed in Chapters 1 and 2 of the IIFP Environmental Report (ER). The IIFP Fluorine Extraction and Depleted Uranium De-conversion Plant (FEP/DUP) facility and plant processes, that are proposed to be constructed and operated near Hobbs, New Mexico, are described in Chapter 1 of the IIFP Environmental Report (ER) of this ER.

Much of the cost to construct and operate the facility effectively translates into benefits for the national, state, regional and local economies. Several benefits are realized such as creation of a substantial number of jobs, utility and tax payments, and procurement of some construction and operating supplies from local businesses.

It must be noted that all Chapters of the ER assess, where applicable, the environmental impacts of not only a Phase 1 near-term construction, with facility operations scheduled to begin in late 2012, but also that of a later expansion to become a Phase 2 facility.

Phase 1 pre-licensing construction could begin as soon as early as 2011, depending on NRC approval of an IIFP pre-licensing construction exemption request. Some of this pre-licensing construction could include the entrance road, administration building, and other non-process related infrastructure construction. The impact assessments of the proposed pre-licensing construction activities are included and discussed in the applicable Chapters of this ER.

IIFP has assessed and included the Phase 2 future expansion as part of the current ER. Buildings and process equipment will be added during the 2015-2016 timeframe resulting in a Phase 2 plant that is scheduled to begin operation in mid year 2016. The Phase 2 plant will consist of additional de-conversion capacity using a process for direct conversion of DUF_6 to uranium oxides (Oxide Process) as described in Chapter 1 of the current ER.

7.1 Proposed Action Economic Cost-Benefits, Facility Construction and Operation

This analysis evaluates the expected economic impact of the Proposed IIFP Facility in Lea County, New Mexico by generally identifying the direct impacts of the plant on revenues of local businesses, on incomes accruing to households, on employment, and on the revenues to state and local government. Further, it explores the indirect impacts of the IIFP facility on local entities.

7.1.1 Introduction

The purpose of ER Section 7.1, “Economic Cost-Benefits, Plant Construction and Operation,” is to describe the economic impact that construction and operation of the IIFP facility would have on the surrounding area, including Lea, Eddy, and Chaves Counties in New Mexico. The analysis includes the economic impact upon a contiguous nine-county region, comprised of the three New Mexico counties, as well as six directly affected Texas counties falling within the 80-km (50-mi) radius region of influence for the proposed facility. These include Andrews, Gaines, Winkler, Yoakum, Loving and Cochran Counties (See Figure 7-1, “Nine-County Economic Impact Area around the IIFP Facility”).

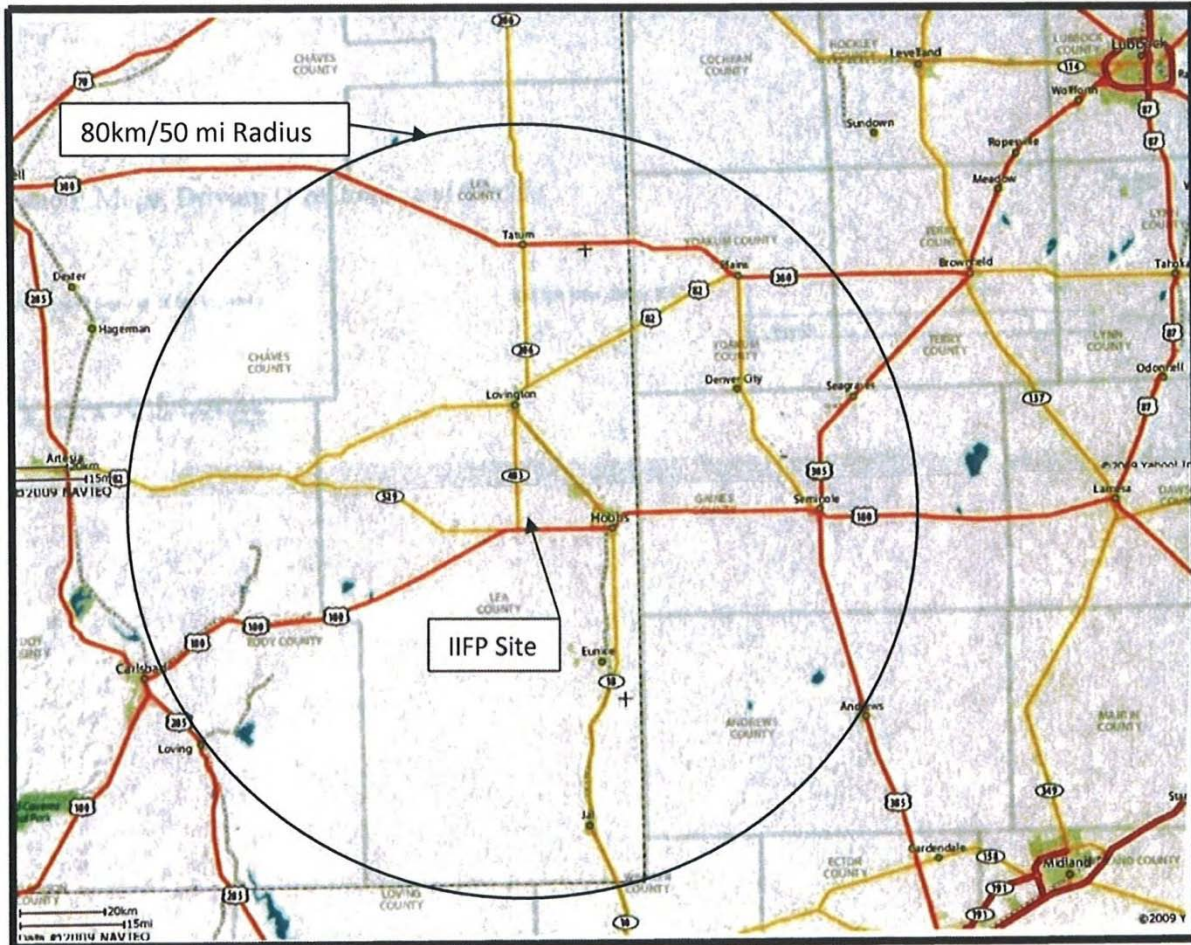

Figure 7- 1 Nine-County Economic Impact Area around the IIFP Facility

The impact analysis is divided into two categories; construction and operations. Analysis for the construction phase presents the capital cost impacts, specifically showing the investment of capital into the regional community. The estimated cost of construction labor is provided along with the estimated cost of engineering, project management and startup material.

Average annual operating costs are provided based on the total Phase 1 and Phase 2 facility. The Phase 1 facility operates only for about three years prior to Phase 2 facility operation. The total Phase 2 facility average annual costs for the long plant life are more representative of the impact on local, regional and State economies. Some of the operating costs are shown as Phase 1 and Phase 2 merely to show the impact in certain categories of the Phase 2 expansion.

ER Section 7.1.2, “Regional Economics,” discusses current economic conditions and existing economic structure of the nine-county region surrounding the Proposed IIFP Facility.

7.1.2 Basis of Construction and Operating Costs-Benefit Estimates for the Proposed Action

The project construction and operation cost estimates assume that project detailed engineering begins in mid-2010, and some pre-licensing construction activities may start by early 2011. Upon approval of the

NRC license application, the full construction is expected to begin by the end of 2011 with startup of the Phase 1 operation for functional testing by end of 2012. It is assumed that the facility would not reach significant production operating levels and receipt of revenue streams until mid- to-late 2013, after operational checkout and test production runs are completed.

Beginning in late 2013, the production of the two fluorine extraction process (FEP) products (SiF_4 and BF_3) and the anhydrous hydrogen fluoride (AHF) by-product is assumed to ramp up over the following six months to approach the operational design capacity in 2014 of about 0.68 million kg/yr (1.5 million lb/yr) of SiF_4 , 0.23 million kg/yr (0.5 million lb/yr) of BF_3 , and about 0.36 million kg/yr (0.36 million lb/yr) of AHF. The Phase 1 plant design capacity for de-conversion is approximately 3.3 million kg/yr (7.3 million lb/yr) or about 270-300 UF_6 cylinders per year.

Costs and benefits estimates are also included for the Phase 2 facility that would be constructed in the 2014-2015 timeframe. Phase 2 facility startup is planned for mid-2016 resulting in an additional DUF_6 de-conversion design capacity of nearly 6.5 million kg/yr (about 14.4 million lb/yr). This will result in a total integrated plant de-conversion capacity of approximately 9.8 million kg/yr (21.7 million lb/yr), or nearly 790 DUF_6 cylinders per year. The Phase 2 capacity provides for production of an additional 2.22 million kg/yr (4.9 million lb/yr) of AHF; increasing the total facility production capacity for AHF to about 2.6 million kg/yr (5.7 million lb/year).

Currently, there is some uncertainty in the timing of actual production levels and related costs and revenues. For the purposes of the ER, reasonable assumptions and estimates are made on the timing and realization of annual production volumes, capital cash flows, operating costs, and revenues used in developing the cost-benefits analysis of this Chapter.

Costs are determined for the facility capital investment and for the recurring annual operations. The capital cost estimate for the IIFP facility is a budget-level type estimate as defined by the American Association of Cost Engineers (AACE). The budget estimate is also referred to as a Conceptual Design Estimate. The purpose of this type of estimate is typically to provide a budget authorization estimate and to evaluate the potential general economic and socioeconomic impacts and expected return on investment.

Likewise, operating costs are developed as budgetary-type estimates. Vendor information is used, where available, for estimating raw material, treating agent, waste disposal, transportation costs and some utilities. Labor and taxes are derived mostly from wage/salary surveys and from the local community and State and federal agency published data. Some indirect overheads, such as insurance, maintenance materials, general administrative expenses, and marketing/distribution are developed using estimation factors based on a typical percentage of direct costs.

Revenues for products and by-products are calculated from the estimated pounds of products and services sold and the projected product unit selling prices for the SiF_4 , BF_3 and AHF. De-conversion revenues are derived from the estimated DUF_6 pounds expected to be contracted for processing in a given year and the unit price for those services. It is assumed, for the purposes of the cost-benefits analysis, that products and service revenue cash flows occur in the year in which products are produced and the services are performed.

The incentives to IIFP being received from the State of New Mexico and Lea County are included as positive cash flows where those are expected to be grants or funds transferred to IIFP for use in offsetting some costs (i.e., such as training, job recruiting, etc.). In cases where the incentives are cost avoidances, such as exemption from certain property taxes, the incentive is simply discounted from what would otherwise be an operating expense to IIFP.

Recurring and one-time costs, other than capital investment, are entered into the analysis as cash flows-out in the year in which those costs and expenses are estimated to occur.

Income taxes and some other taxes are calculated for the year of the respective taxable income. The income tax is estimated and based on the Federal and State rates; as is unemployment taxes. Income taxes are considered as beneficial impacts of the facility to both the U.S. and New Mexico economy. New Mexico gross revenue tax (GRT) is considered a pass-through cost to the IIFP customers, and a benefit to New Mexico and the local community with the benefits of those tax revenues distributed on the basis of the GRT tax rates and codes.

Economic benefits to the local, regional and state communities result mostly from receipts of corporate, property and gross revenue taxes, creation of a significant number of new jobs during pre-licensing and general construction and ongoing operations, and revenue flows to the area and State businesses from the respective goods and services procured by the IIFP facility. A summary of the expected benefits is provided in Section 7.4.

7.1.3 Assumptions in the Cost-Benefit Analysis

The following assumptions are included in the cost-benefit analysis:

- The life of the plant is maintained by replacing capital in the years in which the equipment and life of the infrastructure needs replacement.
- A 40-year analysis is used. The facility is assumed to operate well beyond the 40 years, but this analysis period is assumed sufficiently long to assess impacts and allow time for replacement capital effects to be evaluated as part of the analysis.
- The replacement capital and the annualized costs estimated for the maintenance materials, in addition to annual labor costs, are assumed to maintain the plant in an on-going operational condition through the product life-cycles.
- The operating availability (production on-stream time) of the facility is 85%.
- Capital cost, development and startup expenses are distributed over several years based on the schedule for project deployment and expected cash outflows for each phase of the project.
- Cash inflows and outflows are escalated at an assumed inflation rate of 2.5% per year.
- The cost for product distribution and sale for SiF₄ is calculated and added as approximately 8% of the sale price of the product; whereas BF₃ unit costs include the distribution to a wholesale gas distributor.
- Incentives, infrastructure costs, operating costs, and taxes associated with the Hobbs, New Mexico site are incorporated into the cost/benefit analyses.
- Salary and hourly wages obtained for the Hobbs, New Mexico area are used to determine manpower cost. Salaries and wages are assumed to be average amounts, or slightly higher in some job positions, within the local area.
- The average income tax rate is 39.88% of taxable income for state and federal corporate income taxes. Income tax credit carryover generated from design, construction, and startup expenditures is applied to years where taxable income is positive. Much of the property tax is assumed to be exempt by the state and local governments as part of their incentive package.
- The Straight Line (SL) depreciation method is used for income tax purposes. Actual depreciation methods for most classes of plant assets are likely to be more accelerated, such as the Modified Accelerated Cost Recovery System (MACRS). There is not sufficient information about the asset classes and accounting methods at this time to evaluate or optimize the depreciation method. Therefore, the simple SL method is used.

- The regulatory fee for NRC oversight is assumed to be \$600,000-\$750,000 per year.
- The decommissioning fund financial assurance costs for the Phase 1 facility are derived from the License Application (LA) decommissioning study and plan (See detail estimates in LA Chapter 10). The Phase 2 facility decommissioning detail estimate has not been developed because the current LA being submitted only for approval of the Phase 1 plant. The Phase 2 decommissioning costs are assumed and estimated, at this time, based on the ratio of capital cost and scaling of the Phase 1 decommissioning cost estimate.
- Annual insurance cost is estimated as 1% of the sum of capital cost and pre-startup working capital.

7.1.4 Construction and Pre-Startup Costs

7.1.4.1 Capital Cost Estimating Methods

The accuracy range for a capital cost budgetary-type estimate is typically -15 percent to +30 percent. This range of accuracy is needed to adequately define capital cost requirements for the project at the early design stage. It is a reasonable range for inclusion of the capital cost estimates into financial modeling.

The project budgetary-type capital estimate was developed based on the following conceptual and preliminary engineering plant design information:

- Site location and plot plan.
- Preliminary flow sheets with material balance.
- Preliminary Piping and Instrumentation (P&ID) diagrams.
- Identification of safety class systems and conceptual design requirements.
- Equipment lists with general specifications.
- Selection of materials of construction for major equipment
- Conceptual building, infrastructure and equipment layouts and sizes.
- Preliminary electrical power layout and sizes of substation and distribution.
- Preliminary instrument list.
- Construction craft labor rates for site selected.

7.1.4.2 Capital Cost Estimates for the IIFP Commercial Facility

Table 7-1 is a summary of estimated (expressed in 2009 dollars) capital and one-time development, startup and pre-operational working capital costs for the Phase 1 IIFP FEP/DUP facility. The Phase 2 facility incremental costs for capital and startup are shown in Table 7-2. The total Phase 1 and Phase 2 facility capital and startup costs are given in Table 7-3. Labor costs during construction are provided in Table 7-4.

Equipment and infrastructure replacement capital costs are based on life of the equipment, components and systems with the cash flows occurring in the years that replacement is required and actual costs incurred. The facility replacement costs over a 40-year period are estimated at a total of 60-80 million dollars. An estimated total of 30-45% of that replacement capital would be in labor/installation and in the gross revenue taxes on procured materials; most of which is likely to flow as a benefit into the community and State. Table 7-5 presents a breakout of the estimated replacement costs.

Table 7- 1 Summary of Capital Cost Estimate for Phase 1 IIFP Facility

Fixed Capital	Estimated Costs in Millions (\$) (Year 2009\$)
DUF ₄ Plant	9-12
FEP Plant	15-19
Balance of Plant	15-20
Engineering, Procurement, Construction Management (EPCM)	7-11
Project Mgt & Programs	2-3
Contractor Fees	2-3
Contingency	5-6
Subtotal Capital (Expressed in 2009 \$)	55-74
Development/Startup Expenses	Estimated Costs in Millions (\$) (Year 2009\$)
Regulatory, License, Permits	3-4
Pre-startup Working Capital	9-12
Spare Parts/Start up Inventories	3-4
Subtotal Development/Startup Exp.	15-20
Total Estimated Capital, Development and Startup (in 2009 \$)	70-94

Table 7- 2 Summary of Incremental Capital Cost Estimate for Expansion to Phase 2

Fixed Capital	Estimated Costs in Millions (\$) in 2009\$
DUF ₄ Plant	0
FEP Plant	0
Oxide Add-on Plant	26-34
Balance of Plant Add-on	1-1.5
Engineering, Procurement, Construction Management (EPCM)	7-9
Project Mgt & Programs	1-1.5
Contractor Fees	1-2
Contingency	3-4
Subtotal Capital (Expressed in 2009 \$)	39-52
Development/Startup Expenses	Estimated Costs in Millions (\$) in 2009\$
Regulatory, License, Permits	1-1.5
Pre-startup Working Capital	1-2
Spare Parts/Start up Inventories	1-1.5
Subtotal Development/Startup Exp.	3-5
Total Estimated Capital, Development and Startup (in 2009 \$)	42-57

Table 7- 3 Summary of Capital Cost Estimate for Total IIFP Facility (Phase 1 and 2)

Fixed Capital	Estimated Costs in Millions (\$) (in 2009\$)
DUF ₄ Plant	9-12
SiF ₄ Plant	15-19
Oxide Add-on Plant	26-34
Balance of Plant	16-21.5
Engineering, Procurement, Construction Management (EPCM)	14-20
Project Mgt & Programs	3-4.5
Contractor Fees	3-5
Contingency	8-10
Subtotal Capital (Expressed in 2009 \$)	94-126
Development/Startup Expenses	Estimated Costs in Millions (\$) (in 2009\$)
Regulatory, License, Permits	4-5.5
Pre-startup Working Capital	10-14
Spare Parts/Start up Inventories	4-5.5
Subtotal Development/Startup Exp.	18-25
Total Estimated Capital, Development and Startup (in 2009 \$)	112-151

Table 7- 4 Estimated Construction Labor Costs

Cost Category	Total Construction Period (Approximately 6.5 Years for Two Phases) Millions of Dollars (2009\$)	Average Annual Costs During Construction Period Millions of Dollars (2009\$)
Construction & Installation	36-55	5.5-8.4
Engineering, Procurement & Construction Management	9.8-14.9	1.5-2.3
Project Management	2.5-3.7	0.4-0.6
Total	48.3-73.6	7.4-11.3

Table 7- 5 Estimated Replacement Capital

Time Period of Replacement Cost Projected to be Incurred	Range of Estimated Replacement Costs (Millions of \$) (Expressed in 2009 Dollars)
Years 2010 through 2017	No replacement capital; all is estimated initial capital
2018-2027	9-12
2028-2037	28-36
2038-2050	23-36
Total 40 Year Analysis Period	60-85

7.1.5 Operation Costs

7.1.5.1 Raw Materials

The FEP and De-conversion processes have a relatively low raw materials usage and costs. The main raw material is in the fluoride value that comes from extracted fluorine of the waste uranium enrichment tails material received from the toll de-conversion supplier (customer). Much of the raw materials and treating agents will likely be procured outside the Hobbs and local area owing to availability. There is little economic benefit to the local area relative to procurement of raw materials; however, IIFP will be diligent in using local and State vendors in cases where it is feasible to obtain raw materials from near-by sources. The impacts on the community in transportation of these raw materials are discussed in Section 4.2, Transportation Impacts.

Table 7-6 provides a list of the type of major raw materials and treating agents. Other required miscellaneous chemicals and agents would include laboratory chemicals, lubricating oils, refrigerants, cleaning solutions, boiler additives, and treatment chemicals for sanitary and cooling water. Costs for those miscellaneous materials are collectively included in the supplies category which is estimated as a percentage of maintenance costs.

There is no major difference in the Phase 1 and Phase 2 facility for types and amounts of raw materials. The incremental cost estimates for any increased amounts of treating agents are included in the Phase 2 total operating cost estimate summary.

Table 7- 6 Major Raw Materials and Treating Agents

Raw Material or Treating Agent	Comments
Silicon dioxide (SiO ₂)	Alternative to be evaluated in pilot test. Diatomaceous earth of much less unit cost is an option contingent on the product purity tests.
Boric Oxide (B ₂ O ₃)	Used in production of BF ₃ product.
Calcium Hydroxide [Ca(OH) ₂]	Used in lime treatment of process water to regenerate KOH and neutralize small amounts of aqueous HF wastes
Potassium Hydroxide (KOH)	Treating agent bought as a 45% solution and used in scrubbing emissions from process off gas vents. The agent is regenerated and recycled to avoid process water discharges and to minimize usage. Small make-up is required.
Hydrogen-gaseous (H ₂)	Estimates for economic analysis obtained from vendor quotes assume that supply would come from a packaged system.

7.1.5.2 Utilities

The financial model calculates the annual utility costs from the input data of estimated rates and usages. Cost for electricity and natural gas were developed from rates and schedules provided in the Lea County, New Mexico Economic Development Corporation site selection proposal and ensuing discussions with the County and utility companies.

Unit costs for steam, water and plant air were derived from component rates and engineering calculations. Costs for gaseous nitrogen were obtained from vendor budgetary-type quotes.

Usages and demand loads were calculated and estimated from process engineering and preliminary design data for buildings, processes and balance of plant equipment. Some requirements and demands were estimated based on the best available information and experiences in similar facilities. Estimated rates are listed in Table 7-7.

Table 7- 7 Utility Estimated Rates

Utility	Rate/Unit Cost (Year 2009\$)	Comments
Electricity	\$62.00/megawatt hour	
Natural Gas	\$1.00/therm	Natural gas used by the plant that is not included in the cost of steam
Water	\$0.0023/gallon	Estimated cost of supply pumped and treated from on-site well.
Nitrogen	\$0.90/100 ft ³	
Steam	\$0.012/pound generated	Steam costs include the cost of natural gas, chemical, etc. that go into making a pound of steam
Plant air (compressed)	\$0.20/1000 standard ft ³	Cost of generating on site with plant compressor equipment.

The type of utilities are the same for the Phase 1 and Phase 2 facility, but there is a significant increase in usage of utilities amounts beginning in about 2016, especially in steam and electricity, for the integrated Phase 2 facility after the Oxide plant add-on.

Approximately 2.5 to 3.3 million dollars per year of utilities are estimated to be procured from utility companies located in the region or State thereby benefiting the local and State economies.

7.1.5.3 Selling and Distribution

The FEP products would be sold most likely on a price per pound basis. IIFP currently is exploring arrangements for the high-purity fluoride gases to be sold and distributed through a specialty gas distributor with experience in this market. IIFP has assessed the fluoride markets. Discussions are underway with interested potential buyers or distributors. Costs for marketing, selling and distribution typically range from 2-20% of the total product cost for chemical plants (Timmerhaus, Peters and West, 2003a). Other references suggest that sales and distribution cost are about 20-30% of direct production costs (Sinnott, 2007). The high side of the range usually applies where small quantities of materials are sold to a large number of customers. The higher side also is more applicable where there are several sales offices, sales representatives, and significant amounts of travel and advertising. The IIFP arrangement would be through a small number of distribution channels with a minimum need of advertising and sales locations or staff.

The sales and distribution annual costs used in the IIFP financial analysis for fluoride products, where applicable, are estimated at 8% of the projected product cost. There is no direct selling of the de-conversion services, other than agreements and contracts arranged between IIFP and suppliers/customers. There is essentially no difference in selling and distribution costs of the Phase 1 and future Phase 2 facility. Some marketing and public relations relative to the de-conversion business is expected; but for purposes of the financial analysis, this cost is considered minor.

7.1.5.4 Operational and Maintenance Materials

Material required for repair and normal replacement of equipment and infrastructure is estimated at 5% of the plant direct capital cost not including engineering procurement and construction management costs or contingency. Additionally, replacement capital is estimated and expended as a cash flow in the year in which the equipment or infrastructure would be replaced.

Operating supplies are also included in this category. Operating supplies, for example, include items such as gloves, personnel safety items, office supplies, lab chemicals, lubricating oils, custodial supplies, etc. Operating supplies are estimated at 0.75% of the direct capital costs. These percentages are based on published cost methodology data and experiences at similar facilities (Timmerhaus, Peters and West, 2003b).

An additional level of maintenance and supplies is required for the future Phase 2 facility owing to the increased amount of equipment and buildings that will be added. The processes of the Phase 1 and Phase 2 facilities are generally the same in complexity and types of maintenance.

Not all maintenance materials and operating supplies will be available in the local or regional communities and not in New Mexico. It is assumed that 25-50% of operating supplies, such as office supplies, small maintenance items and custodial supplies, can be bought in the local area or in New Mexico.

Maintenance parts and supplies are somewhat more complicated and may require procurement from manufacturing vendors located outside the State. There are some conventional maintenance materials, lubricants, fasteners, etc. that can likely be procured within the State; an estimate is used of 20-30% of maintenance materials purchased within the local region or State.

The average cost of maintenance materials and operating supplies for the facility is estimated at 3-4 million dollars annually. The total materials and operating supplies estimate for purchasing from suppliers in the local region and New Mexico is between approximately 0.8 and 1.3 million dollars (2009\$) annually.

7.1.5.5 Labor

The number of employees and annual labor costs for the Phase 1 facility is presented in Table 7-8. The census and costs shown represent the estimated number of employees and annual labor cost after the Phase 1 facility operations ramp up at the end of 2013.

Hiring of employees at the New Mexico site is expected to begin as early as 2011. The labor costs and benefits to the community by year, including the startup period, are reflected in the cash flow summary tables presented in Section 7.4.

Table 7- 8 Estimated Labor for Phase 1 Facility

Personnel Classification	Approximate No. Required	Estimated Range of Annual Costs (Thousands of \$) (Year 2009\$)
Hourly-Operations	45-50	2,650 - 2,980
Hourly-Maintenance	35-40	2,060 - 2,320
Salary Employees	40-48	3,200 - 3,800
Total	120-138	7,910 - 9,100

After the Oxide plant is operational in approximately 2016, the employee census increases by about 15-20%. The resulting Phase 2 facility number of employees and annual labor costs are provided as Table 7-9.

Table 7- 9 Estimated Labor for Total IIFP Facility (Phase 1 and 2)

Personnel Classification	Approximate No. Required	Estimated Range of Annual Costs (Thousands of \$) (Year 2009\$)
Hourly-Operations	55-60	3,300 – 3,600
Hourly-Maintenance	45-50	2,650 – 2,950
Salary Employees	45-50	3,600 – 4,000
Total	145-160	9,550 – 10,500

Annual labor costs were developed after identifying each job requirement and conducting wage and salary surveys for each respective job. The surveys for salaried staff are obtained for the Hobbs, New Mexico area and nationwide by a search of survey databases (cb-salary, 2009). Employee benefits are calculated using an overhead rate of 30% of annual salary. Incentives are added as a percentage of the salary to attract some special positions. The total annual salaries are expressed as salary plus benefits and any applied incentives.

Wages for craft, laborers, and hourly wage earners are developed by using average or prevailing wages for the area. Most of the wage estimates are extracted from data published by the State of New Mexico Department of Workforce Solutions (DWS, 2009). Some wage data for certain local area jobs are obtained from the Economic Development Corporation of Lea County (EDCLC, 2008). In cases where a job is highly specialized, a competitive wage factor is applied to ensure attraction of experienced skilled personnel, where needed.

7.1.5.6 Waste Disposal

The major waste for disposal is uranium oxide(s) generated as a by-product in making SiF₄ and BF₃ and also in the direct de-conversion of DUF₆. An average of approximately 0.7-0.8 pounds of oxide are generated for each pound of DUF₆ that is de-converted. IIFP has been considering waste disposal options for the uranium oxide. One licensed large disposal site is currently available in Utah. There is potential for another site in Texas, but several years may be required in licensing that facility for uranium oxide disposal.

The types and estimated quantities of wastes are provided in Chapter 3 of this ER. Measures are used in the IIFP facility to minimize contamination and the amounts of waste, including recycling of paper, cardboard, lubrication oils, and metals.

There are some relatively small amounts of wastes that are inherent to the process that must be disposed as Resource Conservation and Recovery Act (RCRA) waste through a licensed transporter and disposal contractor. Calcium fluoride, typically characterized as RCRA material, is generated as a by-product in the Environmental Protection Process of regeneration and recycle of KOH that is reused in the plant air emissions scrubbing system. IIFP plans to sell the calcium fluoride; however for purposes of the cost-benefit analysis, the maximum RCRA disposal costs provided in the summary tables below conservatively assume the calcium fluoride would be disposed.

Estimated costs used in the economic analysis for low-level radioactive waste (LLW), including the uranium oxide, were obtained from preliminary budgetary-type quotes and discussions with the owners of the licensed disposal facility in Utah. Costs are based on volume of material buried, including the container and free space within the container. Transportation and container costs are added. The oxide waste disposal cost is equivalent to about \$0.90-\$1.05 per pound (in 2009\$).

Disposal costs for miscellaneous wastes that are not LLW, such as sanitary waste, are developed from the estimated amounts of those wastes and the unit costs for disposal. Unit costs of disposal are obtained from cost estimate sources of generally like waste materials being disposed in New Mexico or Texas.

Table 7-10 provides a range of estimated waste disposal costs by type of waste.

Table 7- 10 Estimated Range of Annual Waste Disposal Costs

Type Waste	Phase 1 Facility (Thousand of \$ Per Year in 2009\$)	Phase 2 Facility (Thousands of \$ Per Year in 2009\$)
Depleted uranium oxide	2,600-5,500	8,000-16,000
Other process LLW	1,000-1,700	1,100-1,800
Misc. LLW	225-350	450-650
RCRA	9-20	14-25
Sanitary	1-2	1-2

7.1.5.7 Insurance and Taxes

Insurance is estimated at 1% of the sum of direct capital costs and the cost of spare parts/startup inventory (Timmerhaus, 2003). Workman Compensation insurance is included in the estimated 30% overhead rate applied to the labor costs. It is assumed that most of the insurance can be obtained from firms within New Mexico. Therefore, premiums between 1-1.5 million dollars per year (2009\$) are estimated to be paid within the State.

Property and local taxes are generally exempt as part of the Lea County and State of New Mexico site incentive package. There are two educational local school taxes that are not part of the exemption. The annual estimate of those taxes is based on a formula and information provided by the Lea County Economic Development Corporation. Those annual property taxes are estimated at an average of \$350,000 annually for the total Phase 1 and Phase 2 facility.

State of New Mexico unemployment and Federal unemployment, Social Security, and Medicare taxes are included in the estimated 30% overhead rate applied to labor costs.

Corporate income taxes for the IIFP plant operations are calculated on an average federal rate of 35% of taxable income plus the State of New Mexico income tax of 7.5% of taxable income. The state income taxes are credited as being an offsetting expense on federal taxes.

A summary of estimated tax revenues to the County and State is presented in Table 7-11. The tax receipts that benefit the communities are based on IIFP corporate income tax, property tax, and New Mexico and Lea County Gross Receipts Tax. The tax receipt estimates do not include the personal income taxes or property taxes paid to the community or State in which employees will live; those benefits to the respective communities are considered as part of the labor dollars expected to flow into the community.

Table 7- 11 Estimated Tax Revenues to State and Local Communities for Total 40-Year Period Expressed in Thousands of Dollars in Year 2009\$)

Type of Tax ^a	New Mexico	Lea County	Total
Gross Receipts Tax			
High Estimate	283,300	21,400	304,700
Low Estimate	209,300	15,300	224,600
NM Corporate Income Tax^b			
High Estimate	299,600	N/A ^c	299,600
Low Estimate	221,400	N/A ^c	221,400
NM Property Tax			
High Estimate	1,700	16,000	17,700
Low Estimate	1,100	10,500	11,600
TOTAL TAX ESTIMATE RANGE	431,800-584,600	25,800-37,400	457,600 to 622,000

^aTax Values based on Tax Rates as of 2009

^bBased on Average Earnings over the 40-Yr Analysis Period for the Proposed IIFP Facility

^cAllocation would be made to the State of New Mexico

7.1.5.8 Decommissioning Fund

A Decommission Funding Plan (DFP) is developed and provided as Chapter 10 of the IIFP NRC License Application.

IIFP presently intends to utilize a surety bond and Standby Trust Fund as the method to provide reasonable financial assurance of decommissioning funding. At least six months prior to startup of the Phase 1 facility, IIFP will provide NRC the financial assurance instrument that IIFP intends to execute. Upon finalization of the specific funding instrument to be used and at least 21 days prior to the commencement of operations, IIFP will supplement its application to include the signed, executed documentation. The surety bond and fund will provide assurance that decommissioning costs will be paid in the unexpected event IIFP is unable to meet its decommissioning obligations at the time of decommissioning.

The decommissioning cost estimate and financial assurance is provided for the Phase 1 facility license application that is currently being submitted. The Phase 1 decommissioning cost is estimated at 12 to 15 million dollars (2009\$). A detail cost estimate of the Phase 2 expansion has not been developed at this time. Expansion of the plant to Phase 2 will require amendments to the IIFP license, and the DFP will be updated and re-submitted to the NRC for approval prior to construction of the Phase 2 portion of the facility. However, based on a ratio of capital investment and scaling, an estimate for the decommissioning the Phase 2 expansion is in the order of an additional 2-3 million dollars (2009\$); a total for the facility (Phase 1 and Phase 2) of 14 to 18 million dollars.

The overall strategy for decommissioning is to decontaminate or remove materials from the site in order to release the facility and the site for unrestricted use. This approach begins shortly after final shutdown

of the facility and avoids long-term storage and monitoring of wastes on site. The type and volume of wastes produced at the IIFP facility do not warrant delays in waste removal normally associated with a deferred dismantlement option.

Hazardous wastes will be treated or disposed of in licensed hazardous waste facilities. Disposal of radioactive or hazardous material will not occur at the plant site, but at licensed facilities located elsewhere. Following decommissioning, the facilities, infrastructure and site will be available for reuse.

At the end of useful plant life, the IIFP facility will be decommissioned such that the site and remaining facilities may be released for unrestricted use as defined in 10 CFR 20.1402 (CFR, 2008b).

The cost impact of facility shutdown and decommissioning is mostly in the loss of the facility jobs, tax revenues and other revenues to local businesses. However, for approximately 2 years of decommissioning activities, an estimated 25-40 jobs (~ \$3.2 to 5 million) are expected to remain in the local economy to carry out the decommissioning work. Some relatively small amount of utilities and materials would be purchased from businesses in the region, and the associated gross revenue taxes, income taxes and property taxes would continue to be a contribution to the governments, although a fraction of the amounts during the operating years.

Transportation activities during the decommissioning period are a lesser impact than that already evaluated for the operating facility. The environmental impacts of decommissioning are further discussed in Chapter 4 of this ER, The impact of the decommissioning activities alone to the local region, New Mexico and Texas, are relatively small.

7.2 Regional Economics

A socioeconomic profile of the nine-county region surrounding the IIFP facility provides a baseline from which to understand and measure the economic impacts expected to be derived from the IIFP plant. This section includes a discussion of recent regional trends in output and employment, income and other socioeconomic measures and concludes with a brief discussion on the industry structure of the region.

7.2.1. Recent Trends in Economic Growth and Employment

The subject nine-county region had a total population of 331,774 in 2000 at the latest complete U.S. Census count. About 50.5% of the region's population was residents of New Mexico, while the remaining 49.5% were residents of Texas. For 2003, the population had decreased to 331,716, only a 0.02% reduction. Most counties had suffered a decline in population except for Ector which experienced a growth of 569 people. See Table 7-12, "Nine-County Region Population," for a county-by-county change during that time span.

After rising through the late 1990s, economic growth in New Mexico and Texas slowed in 2001 along with the slowdown in growth of the U.S. economy. Even with the drastic economic downturn of 2001, which impacted Texas much more than most other areas of the nation, Texas gained an additional 1.26 million residents from 2000 through 2003, for a total of 22 million, again growing twice as fast as the nation. Although domestic in-migration (people moving to Texas from other states within the United States) slowed during Texas' hard economic times, the state's high birthrate and a strong pace of immigration kept population growing at a healthy speed. The combination of these factors (higher international immigration, a high Hispanic birthrate and less domestic migration) resulted in Texas' Anglo population dipping below the majority level of 50% in 2003 for the first time since the 1800s.

Table 7- 12 Nine-County Region Population

County	Square Miles	2000 Population	2003 Population	Change (%)	State Rank ¹
Chaves Co. NM	6,070	61,382	60,591	-1.3	23
Eddy Co. NM	4,182	51,658	51,470	-0.4	18
Lea Co. NM	4,392	55,511	55,504	0.0	17
Andrews Co. TX	4,501	13,004	12,868	-1.0	168
Cochran Co. TX	775	3,730	3,486	-6.5	239
Gaines Co. TX	1,502	14,467	14,438	-0.2	142
Loving Co. TX ²	673	67	62	-7.5	244
Winkler Co. TX	841	7,173	6,780	-5.5	228
Yoakum Co. TX	800	7,322	7,249	-1.0	166

¹For New Mexico, 33 counties. For Texas, 254 counties

²Smallest county in the nation by population, lowest poverty rate in the nation (0.0%)

Sources: U.S. Census Bureau, 2000; ePodunk, 2009

Blacks still account for 11% of the state’s population. See Figure 7-2 for the change in ethnicity/race from 1980 through 2003 (FRBD, 2005). The Odessa, Texas metropolitan area experienced the highest percentage growth rate in the state with a 1.8% growth from May 2008 to May 2009. During that same time span, the Texas population declined 2.2% (RSC, 2009).

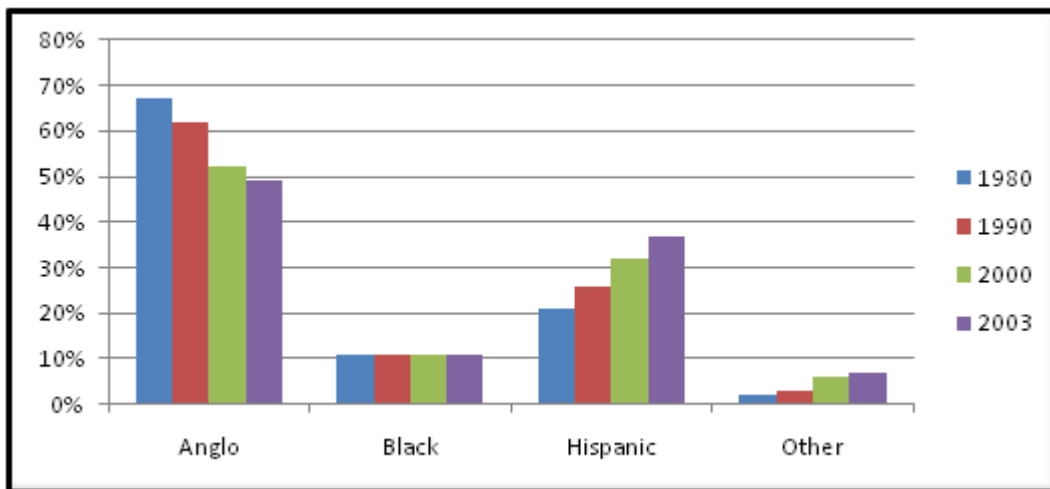

Source: (FRBD, 2005)

Figure 7- 2 Change in Ethnicity/Race for Texas

The state’s economy lost 222,400 jobs from May 2008 to May 2009, an annual job loss of 2.1%. Over the same period, the U.S. economy lost more than 5.5 million jobs or 4% of its total nonfarm jobs. The state’s seasonally adjusted unemployment rate rose from 4.7% in May 2008 to 7.1% in May 2009. The U.S. seasonally adjusted unemployment rate rose from 5.5% to 9.4% during the same period (RSC, 2009). Additionally, New Mexico experienced a statistically significant unemployment rate change from April 2009 to May 2009, seasonally adjusted, from 5.8% to 6.5% (BLS, 2009).

The Odessa metropolitan area experienced a 7.8% unemployment rate in May 2009. This area was the 21st of 26 metropolitan areas reported and was notably higher than the Texas statewide rate (RSC, 2009).

For the first quarter of 2009, Chaves County had a 5% unemployment rate with Lea County experiencing a 4.2% rate followed by Eddy County with a 4.2% rate (BBER, 2009).

7.2.2 Trends in Income

7.2.2.1 New Mexico Income/Poverty

In 2000, the median household income in the average New Mexico County was \$30,603. This was the lowest median household income in the Western Region except for Montana. More discouraging was that the average New Mexico County had the highest rate in the region of households that are living in poverty (20.5%). Making low incomes and high poverty rates even more problematic, there are some segments of the population that are doing much worse than others. Specifically, metropolitan households are doing much better economically than nonmetropolitan households and white households are doing much better than minority households (See Figure 7-3). For example, the average white household in a metropolitan county earned \$41,966, compared to \$33,581 for the average white household in a nonmetropolitan county, \$30,519 for minority households in metropolitan counties and \$24,437 for minority households in nonmetropolitan counties (WRDC, 2008).

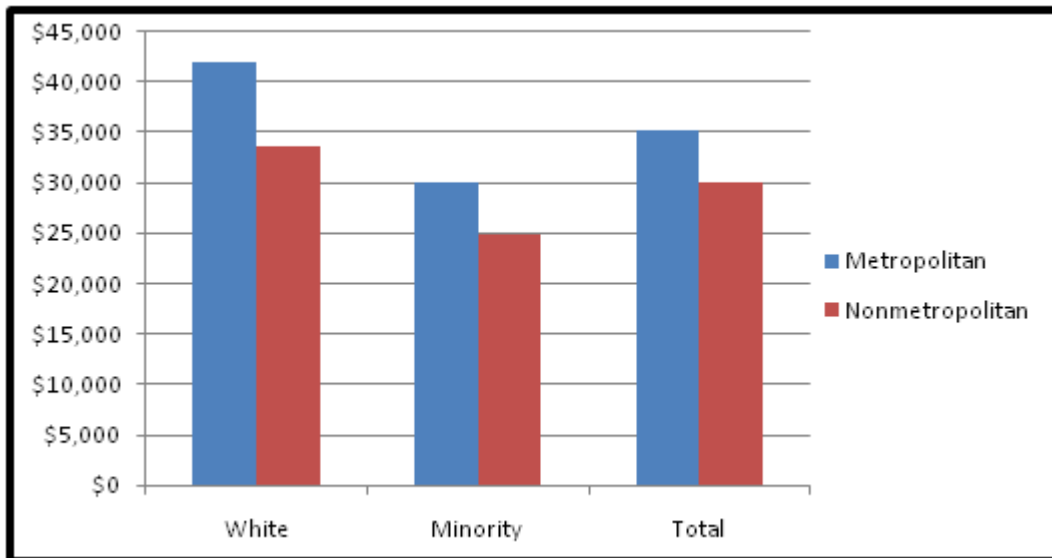

Source: (WRDC, 2008)

Figure 7- 3 Median Household Income by Race/Ethnicity in Metropolitan and Nonmetropolitan Counties in New Mexico, 2000

Thus, the average minority household in a nonmetropolitan county earned only 58% as much as the average white household in a metropolitan county.

Similarly, white and metropolitan households were much less likely to be in poverty than minority and nonmetropolitan households (See Figure 7.4).

The data presented in Figure 7-5 show poverty levels by family structure. While 10.8% of married-

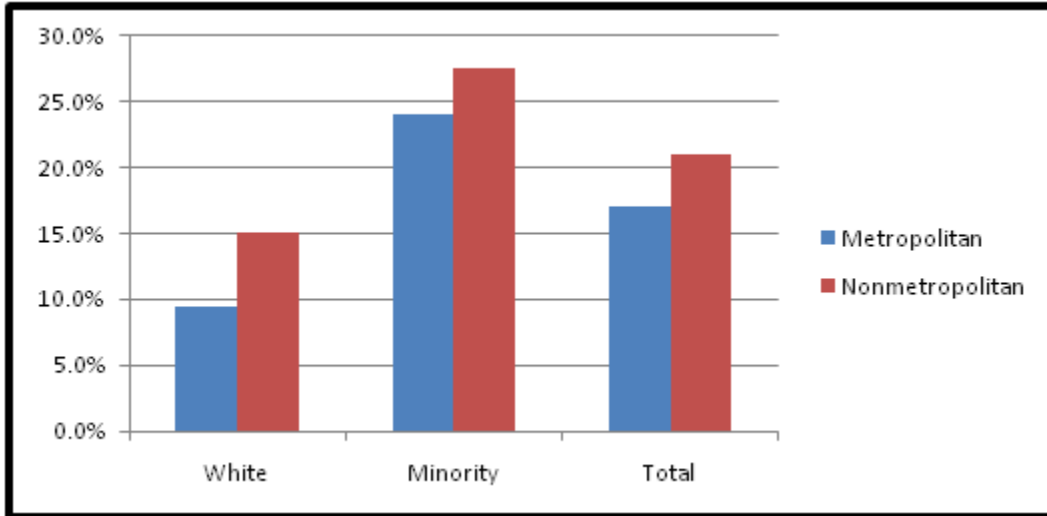

Source: (WRDC, 2008)

Figure 7- 4 Percent of Households in Poverty by Race/Ethnicity in Metropolitan and Nonmetropolitan Counties in New Mexico, 2000

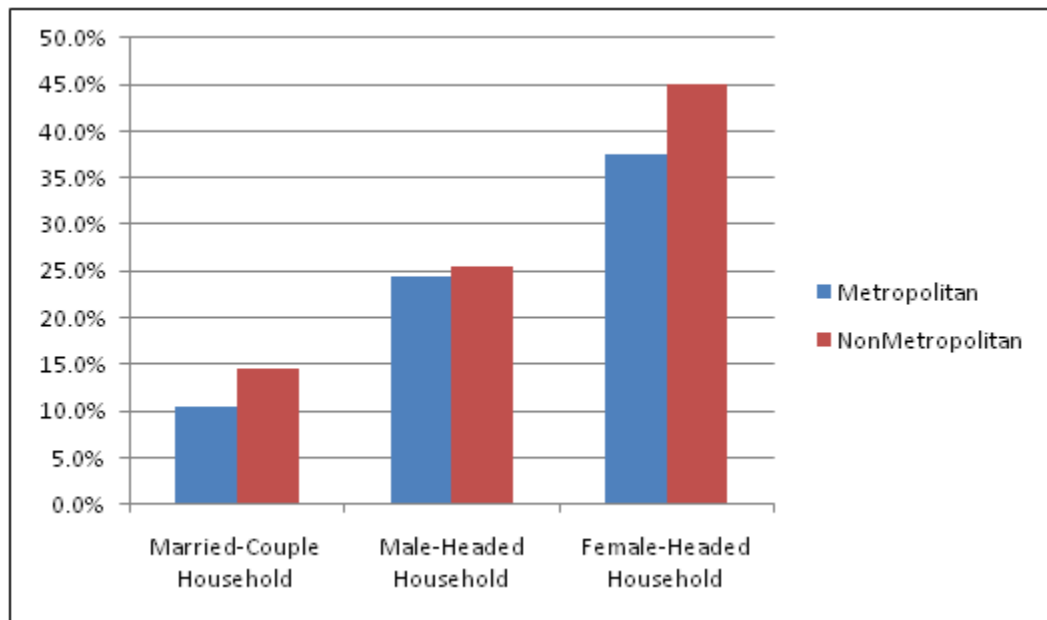

Source: (WRDC, 2008)

Figure 7- 5 Percent of Households in Poverty by Household Structure in Metropolitan and Nonmetropolitan Counties in New Mexico, 2000

couple households in metropolitan counties were living in poverty in 2000, nearly one-half (45.4%) of female headed households in nonmetropolitan counties were living in poverty. This is very troubling in a state where 14% of the households in the state are female-headed, which is the highest proportion of all the states in the Western Region (WRDC, 2008).

7.2.2.2 Texas Income/Poverty

Although Texans' incomes improved during the 1990s, succeeding years have seen a reversal of this phenomenon. According to 2003 data, the Texas poverty rate rose to 16.3% and Texas nominal per capita income fell to 93% (\$29,372) of the U.S. average (\$31,632) as the Texas economy slumped into the recession that started in 2001 and lasted until mid-2003. The State's higher concentration of high-tech and transportation industries, which were the hardest hit, intensified the recession's impact. Hence, these industries shed a substantial number of high-paying jobs, pushing down the State's per capita income more so than the U.S. average. Also, Texas' recovery from the recession has been unusually weak (FRBD, 2005).

If the income differential between Anglos and non-Anglos persists, a larger share of Texans could be drawn into poverty in the future. The share of households with annual incomes of \$25,000 or less will increase from 30.7% (in 2000) to 37.5% by 2040. Moreover, the percentage of families with earnings exceeding \$100,000 will fall from 11.5% to 8.5%. The net impact could be a decline in real income, reduced tax revenue per household and increased burden of the state government to pay for welfare services in Texas. As the state is likely to depend progressively more on non-Anglo Texans for future tax revenues, it is important to lessen the existing wage gap and education differential between ethnic groups (FRBD, 2005).

Among ethnic groups, Hispanics are undoubtedly the largest segment in poverty in Texas. In 1999, more than 1.6 million (25.4%) Hispanics in Texas were poor. Their median household income was \$29,873, far below the Texas average of \$39,926. This is an alarming number, given the importance of this segment to Texas' future (FRBD, 2005).

African-Americans/Blacks had the second-highest poverty rate (23.4%) with a median income less than that of Hispanics. Anglos fared best, with the lowest poverty rate (7.8%) and the highest median household income (\$47,162 in 1999) in Texas (FRBD, 2005).

7.2.2.3 Local Nine-County Income

While per capita income in both New Mexico and Texas is below the national average of \$21,587, standing at \$17,261 and \$19,617 respectively, per capita income is notably lower in the nine-county region. As shown in Table 7-13, the per capita income in the nine-county region ranges from a low of 13,088 for Gaines County, Texas to a high of \$15,916 for Andrews County, Texas (DOC, 2002; ePodunk, 2009).

For this region as a whole, per capita income was \$15,794. This amount is only 73% of the national per capita income. Lea, Eddy, and Chaves Counties in New Mexico had an average per capita income of \$14,999, and the five Texas Counties had an average per capita income of \$14,072 (DOC, 2002). The White per capita income for the New Mexico Counties averaged \$17,153 while the Hispanic or Latino per capita income averaged \$9,219 (53% of the Whites). For the five Texas Counties, the White per capita income averaged \$16,214 and the Hispanic/Latino per capita income averaged only \$8,003 (only 49% of the Whites). Comparison of the median household incomes also shows the relatively weak economic performance of the region. The three New Mexico Counties' median household income averaged 88% of the state and only 72% of the nation's median household income. Similarly, the five Texas Counties' median household income averaged only 83% and 79% of the state and U.S. median household income, respectively.

Table 7- 13 Income Levels for the Nine-County Region

County	Median Household Income ¹ (\$)	Per Capita Income ² (\$)	White Per Capita Income ³ (\$)	Hispanic or Latino Per Capita Income ⁴ (\$)
Chaves C. NM	28,513	14,990	17,377	8,825
Eddy Co. NM	31,998	15,823	17,304	10,165
Lea Co. NM	29,799	14,184	16,778	8,667
Andrews Co. TX	34,036	15,916	18,119	9,016
Cochran Co TX	27,525	13,125	16,078	7,810
Gaines Co. TX	30,432	13,088	14,271	7,979
Loving Co. TX	40,000	24,084	28,249	4,983
Winkler Co. TX	30,591	13,725	15,635	7,771
Yoakum Co. TX	32,672	14,504	16,967	7,439

Sources: U.S. Census Bureau, 2000; ePodunk

¹Median Household Income: New Mexico \$34,133; Texas \$39,927; U.S. \$41,994

²Per Capita Income; New Mexico \$17,261; Texas \$19,617; U.S. \$21,587

³White Per Capita Income; New Mexico \$17,261, Texas \$22,282, U.S. \$23,918

⁴Hispanic or Latino Per Capita Income; New Mexico \$12,045, Texas \$10,770, U.S. \$12,111

Based on IIFP labor cost estimates, the specific jobs created by the IIFP plant pay higher averaged-wages than the regional average income. The Lea County Economic Development Council data reports the 2008 average wage per job in the Hobbs, New Mexico as \$54,300. The national average is \$64,400. In contrast, IIFP expects to pay an estimated average wages/salary between \$62,000-70,000 (benefits included) to its facility employees.

7.3 No-Action Alternative and Reasonable Alternative Actions

The No-Action Alternative is not to build the Proposed IIFP Facility. Under the No-Action Alternative, the proposed site is assumed to continue to remain in its current status and the potential impacts of constructing and operating the proposed IIFP plant would not occur. Although the No-Action Alternative would avoid the potential environmental impacts to the Proposed IIFP Facility area, it could lead to impacts at other locations. Under the No-Action Alternative, for example, uranium enrichment facilities seeking licenses from the NRC would still ultimately need uranium de-conversion services.

The socioeconomic cost impacts of the Proposed Action would be negated in a No-Action Alternative, but significant economic and socioeconomic benefits, as described in previous Sections, to the local communities and respective States would also be lost.

If a Reasonable Alternative Action could be employed, such as using the DOE or another de-conversion technology or expanding the DOE facilities, the alternative action could also lead to similar environmental impacts at other locations. The advantages in the IIFP Proposed Action of recovering fluorine from DUF₆ and using it for producing valuable fluoride gas products, including uses in the solar energy industry, would diminish if alternative known technologies were used for production of the fluoride gases. The production of elemental fluorine or direct production of hydrofluoric acid as raw materials, for use in a direct fluorination alternative, may require technologies involving relatively large chemical processes, other hazardous materials and potentially larger uses of energy.

Chapter 2 of this ER further describes the No-Action Alternative and Reasonable Action Alternatives.

Table 7-14 provides a summary of the socioeconomic impacts of the alternative scenarios. Again, impacts are presented in relative terms.

Table 7- 14 Socioeconomic Impacts of the No-Action and Reasonable Alternative Scenarios

Benefit/Cost	No-Action Alternative	Reasonable Alternative
Construction		
Employment/Economic Activity	No Local Impact	Similar Impact as the Proposed Alternative if a New Facility Was Built. Lesser Impact if the DOE De-conversion Facilities Were Expanded. Lesser impact if DUF ₆ were shipped overseas.
Population/Housing	No Local Impact	Similar Impact as the Proposed Alternative if a New Facility Was Built or a Lesser Impact if the DOE De-conversion Facilities Were Expanded. Lesser impact if DUF ₆ were shipped overseas.
Public Services/Financing	No Local Impact	Similar Impact as the Proposed Alternative if a New Facility Was Built. Much Lesser Impact for expansion of the DOE De-conversion Facilities. Lesser impact if DUF ₆ were shipped overseas.
Operations		
Employment/Economic Activity	No Local Impact	Similar Impact as the Proposed Alternative if a New Facility Was Built Minimal Impact if the DOE De-conversion Facilities Were Expanded. Lesser impact if DUF ₆ were shipped overseas.
Population/Housing	No Local Impact	Similar Impact as the Proposed Alternative if a New Facility Was Built. No Significant Impact if the DOE De-conversion Facilities Were Expanded. Lesser impact if DUF ₆ were shipped overseas.
Public Services/Financing	No Local Impact	Similar Impact as the Proposed Alternative if a New Facility Was Built. Lesser Impact if the DOE De-conversion Facilities Were Expanded. Lesser impact if DUF ₆ were shipped overseas.

7.4 Summary of Cost-Benefits of the Proposed IIFP Facility

This section is a summary of the quantitative and qualitative cost and benefits of the Proposed IIFP Facility in Lea County, New Mexico. Implementation of the IIFP Proposed Action provides measureable economic benefits to the local, regional and State communities. Table 7-15 summarizes the expenditures and jobs expected for the IIFP Proposed Action.

Some costs to local, regional and state communities and governments are expected from the increased demand in services and infrastructure, such as schools, public utilities and roads but the increase is relatively small and expected to be within the service capacity. For example, assuming that all employees or construction workers live in one of the more populated towns, Hobbs, NM or Andrews, TX, and that each worker has an average 4-member family, the population of those communities increase by about 1-1.5% (based on the 2000 census). In actuality, the workers are more likely to live in a broader

Table 7- 15 Estimated Expenditures and Expected Created Jobs

Activity	Phase 1	Incremental Expansion to Phase 2	Total Phase 2 (Phase 1 + Phase 2)
Construction (in 2009 Dollars)	\$70-\$94 million	\$42-\$57 million	\$112-\$151 million
Operations (in 2009 Dollars)	Approx. \$27 million/yr	Approx. \$17 million/yr	Approx. \$44 million/yr
Decommissioning (in 2009 Dollars)	\$12-\$15 million	\$2-\$3 million	\$14-\$18 million
Number of Construction Jobs	120-140	30-40	150-180
Number of Operations Jobs	120-138	Approx. 22-25	145-160

geographical area, and the impact on public services seems very small. Impact to transportation infrastructure is also small and is described in Chapter 4 of this ER.

Significant benefits to the local, regional and state communities are derived from the capital investment expenditures and recurring operations. Table 7-16 presents a summary of estimated economic benefits expected to be realized by the regional community and state as a result of facility construction and operation dollars being expended within the respective surrounding geographical region.

Table 7- 16 Estimated Economic Benefits to Region (Local and State) Surrounding the IIFP

Category	Thousands of Dollars (2009\$) Annually	Annual Benefits Normalized for 40-Yr Period (Thousands of 2009\$)
Construction Labor	\$7,400-\$11,300 (for 6.5 years)	\$1,200-\$1,840
Construction Materials	\$1,740-\$2,600 (for 6.5 years)	\$280-\$420
Replacement Capital	\$1,500-\$2,100	\$1,500-\$2,100
Operating Labor Wages/Salaries	\$7,900-\$9,100 (Phase 1) \$9,500-\$10,500 (Phase 2)	\$8,800-\$10,400
Waste Disposal Fees in State	\$15-\$27	\$15-\$27
Insurance Premiums & Taxes	\$12,500-\$17,000	\$12,500-\$17,000
Utilities	\$2,500-\$3,300	\$2,500-\$3,300
Maintenance Materials & Supplies	\$800-\$1,300	\$800-\$1,300
TOTAL		\$27,595-\$36,387

The cost-benefit impact results are summarized qualitatively in Table 7-17.

Table 7- 17 Qualitative Environmental Costs/Benefits During Construction and Operation of the IIFP Facility

Qualitative Costs Determination	Evaluation
Change in real estate values in areas and communities adjacent to the facility (e.g., land, homes, rental property etc.)	Potentially inflationary
Traffic changes along local streets and highways	Some increases during shift changes
Demand on local services, public utilities, schools, etc.	Some increased utilization expected, but within services capacity
Impact to natural environmental components (e.g., ecology, water quality, air quality, etc.)	Minimal impacts
Alteration of aesthetic, scenic, historic, or archaeological areas or values	No measurable impact
Change in local recreational potential	Not significant
Qualitative Benefits	Evaluation
Site soil stabilization and erosion reduction	Beneficial
Incentive for development of other ancillary/support business development resulting from presence of IIFP facility	Beneficial
Change in real estate values in areas/communities adjacent to the facility (e.g., land, homes, rental property etc.)	Potentially beneficial
Increase in local employment opportunities	Beneficial
Impacts to local retail trade and services	Beneficial
Development of local workforce capabilities	Beneficial

8 SUMMARY OF ENVIRONMENTAL CONSEQUENCES

This section summarizes the environmental consequences for the Proposed Action that cannot be avoided and for which no practical means of mitigation are available to completely eliminate the impacts. Identification and description of the environmental impacts for the Proposed Action that would result from the pre-licensing and general construction, operation, and decommissioning of the Proposed IIFP Facility are presented in ER Chapter 4, “Environmental Impacts.” The mitigation measures that would be incorporated into the Proposed Action to control and minimize potential adverse environmental impacts are summarized in ER Chapter 5, “Mitigation Measures.”

8.1 Unavoidable Adverse Environmental Impacts

Implementing the Proposed Action would result in some unavoidable adverse impacts on the environment. The types and magnitudes of these impacts would vary during the pre-licensing and general construction, operation, and decommissioning phases for the Proposed IIFP Facility. Environmental impacts from an action that are not detectable or are so minor that they will neither destabilize nor noticeably alter any important attribute of an applicable environmental resource are assigned the significance level of SMALL. When the environmental impacts from an action are sufficient to alter noticeably, but not to destabilize, important attributes of a resource, a significance level of MODERATE is assigned. Environmental impacts that are clearly noticeable and are sufficient to destabilize important attributes of a resource are assigned the significance level of LARGE.

In general, the unavoidable residual adverse impacts for the Proposed Action after implementation of mitigation measures to control and minimize potential adverse impacts would be SMALL, with the exception of MODERATE impacts for transportation and ecological resources. On a regional basis, the impacts for these resources also would be SMALL. No LARGE adverse environmental impacts are identified for the Proposed Action. The environmental impacts by resource category for the Proposed Action are summarized for each phase of the project life (i.e., IIFP facility site preparation and construction, operation, and decommissioning). The summaries are based on detailed impact discussions and incorporate the impact mitigation measures for each resource category presented in the corresponding section in Chapter 4.

8.2 Irreversible and Irretrievable Commitments of Resources Used In Project Construction and Operation

Section 5.8 of NUREG-1748, “Environmental Review Guidance for Licensing Actions Associated with NMSS (Nuclear Material Safety and Safeguards) Programs” (NRC, 2003), defines an “irreversible” commitment and an “irretrievable” commitment as follows:

- “Irreversible” refers to the commitment of environmental resources that cannot be restored.
- “Irretrievable” refers to the commitment of material resources that once used cannot be recycled or restored for other uses by practical means.

8.2.1 Irreversible Resource Commitments

No commitments of environmental resources at, or in proximity to IIFP site, were identified for the pre-licensing and general construction, operation, and decommissioning of the Proposed IIFP Facility that ultimately could not be restored after facility closure and decommissioning for unrestricted use (excluding the material resources discussed in Section 8.2.2). Water required for Proposed IIFP Facility operations would be obtained from Ogallala aquifer. Process water would be recycled. Sanitary waste water would

be treated to meet applicable water quality standards and then discharged back to the environment for landscape needs. No solid wastes generated by the Proposed IIFP Facility operations would be land-disposed at the site. At the end of the Proposed IIFP Facility's operational life, IIFP is planning to decommission the facility and restore the facility site for unrestricted use. This would make the site available for a future alternative land use. No historically significant archaeological sites were identified within the IIFP site. The transportation, air quality, noise, and public and occupational health impacts associated with the Proposed IIFP Facility operations would cease with the permanent shutdown and decommissioning of the facility.

The Proposed IIFP Facility would require the irreversible commitment of land use resources at those off-site licensed disposal facilities that would be used for the permanent disposal of the wastes generated by the pre-licensing and general construction, operation, and decommissioning of the facility. These wastes include nonhazardous wastes, hazardous wastes, low-level wastes, and mixed wastes (see Section 4.13.2).

8.2.2 Irretrievable Resource Commitments

The construction of the Proposed IIFP Facility would require commitments of significant quantities of concrete, steel, nonferrous metals, plastics, and other material resources to the manufacturing of the equipment and the building of the structures required for the operation of the facility. The specific types and quantities of these materials would depend on the final facility design. Upon permanent cessation of facility operations, certain types of these building materials and used equipment could be recycled after completing decontamination and dismantling of such materials or equipment. The disposal of remaining unusable or contaminated materials or equipment would be an irretrievable commitment of material resources.

The fluorine extraction/uranium de-conversion process and ancillary equipment that would be used for the Proposed IIFP Facility during operations are powered by electricity. The electrical power required for Proposed IIFP Facility operations would be supplied by the local electric utility companies, which produce electricity using gas-fired plants to supply power to the grid. At times of electric utility power outages, stand-by power would be provided by the Proposed IIFP Facility's on-site diesel electric generators. In addition, diesel fuel and gasoline would be used to operate the motor vehicles used for the Proposed IIFP Facility pre-licensing and general construction, operation, and decommissioning. The electrical energy and fuel consumption for the Proposed IIFP Facility would depend on the final facility design. The consumption of gas or fossil fuels to provide the energy to operate the Proposed IIFP Facility would be an irretrievable commitment of material resources.

The Proposed IIFP Facility pre-licensing and general construction, operation, and decommissioning would generate a combination of nonhazardous, hazardous, and radioactive waste streams. Those waste materials that could not be recovered or recycled, and, therefore, would need to be disposed by burial in an approved, licensed off-site landfill, would represent an irretrievable commitment of material resources. Hazardous, LLW, and mixed LLW shipped off site to a licensed disposal facility would permanently remove a portion of land surface area for other land uses by virtue of its disposal at such an off-site facility.

The Proposed IIFP Facility will be built on 16.2 ha (40 ac) of a 259-ha (640-ac) Section. The site is currently undeveloped. Construction activities including permanent plant structures will disturb approximately 16.2 ha (40 ac). The Lea County Soils Survey (USDA, 1974) describes soils found at the IIFP site as applicable for range, wildlife and recreation areas, and not for any standard agricultural activities. Construction activities and operation of the IIFP plant are thus not anticipated to displace any potential agrarian use.

The IIFP design serves to minimize the use of depletable resources. Water is the primary depletable resource used at the facility. Electric power usage also depletes fuel sources used in the production of the power. Other depletable resources are used only in small quantities. Chemical usage is minimized not only to conserve resources, but also to preclude excessive waste production. Recyclable materials are used and recycled wherever practicable.

The IIFP facility is also designed to minimize the usage of natural and depletable resources as shown by the following measures:

- The use of low-water consumption landscaping versus conventional landscaping reduces water usage.
- The installation of low-flow toilets, sinks and showers reduces water usage when compared to standard flow fixtures.
- Localized floor washing using mops and self-contained cleaning machines reduces water usage compared to conventional washing with a hose twice per week.
- The use of high-efficiency washing machines compared to standard machines reduces water usage.
- The main feature incorporated in the IIFP facility to limit water consumption is the use of closed-loop cooling systems.
- Power usage is minimized by efficient design of lighting systems, selection of high-efficiency motors, use of appropriate building insulation materials, and other good engineering practices.

Additional anticipated effects and impacts on the land use, soils, water resources, historical/cultural resources, ecological resources, visual/scenic resources, etc during construction and operational activities are discussed in Section 8.3 and Section 8.4, "Relationship Between Short-Term Use of The Environment and The Maintenance and Enhancement of Long-Term Productivity."

8.3 Short-Term and Long-Term Impacts

Section 5.8 of NUREG-1748 (NRC, 2003) defines a short-term period and a long-term period as follows:

- "Short-term" represents the period from start of construction to the end of the Proposed Action, including prompt decommissioning.
- "Long-term" represents the period extending beyond the end of the Proposed Action.

The short-term environmental impacts for the Proposed IIFP Facility are the impacts summarized below. Long-term environmental impacts identified for the Proposed IIFP Facility are related to land use beyond the permanent closure of the Proposed IIFP Facility. As discussed in Section 8.2.1, although the future land use of the area on which the Proposed IIFP Facility would be located is expected to be unrestricted, the actual long-term use of the land would likely remain an industrial or business use. Similarly, wastes generated by the Proposed IIFP Facility and sent off site for land disposal would remove land from future alternative uses.

8.3.1 Land Use Impacts

During the construction phases of the IIFP site, conventional earthmoving and grading equipment will be used. The removal of very dense soil or caliche may require the use of heavy equipment with ripping tools. Soil removal work for foundations will be controlled to reduce over-excavation to minimize

construction costs. In addition, loose soil and/or damaged caliche will be removed prior to installation of foundations for seismically designed structures.

The anticipated effects on the soil during construction activities are limited to a potential short-term increase in soil erosion. However, this will be mitigated by proper construction best management practices (BMPs). These practices include minimizing the construction footprint to the extent possible, limiting site slopes to a horizontal to vertical ratio of three to one or less, the use of a sedimentation retention basins, protection of undisturbed areas with silt fencing and straw bales as appropriate, and site stabilization practices such as placing crushed stone on top of disturbed soil in areas of concentrated runoff. After construction is complete, the site will be stabilized with natural, low-water maintenance landscaping and pavement.

Impacts to land and groundwater will be controlled during construction activities through compliance with the National Pollution Discharge Elimination System (NPDES) Construction General Permit obtained from Region 6 of the Environmental Protection Agency (EPA). A Spill Prevention, Control and Countermeasures (SPCC) plan will also be implemented during construction to minimize environmental impacts from potential spills and to ensure prompt and appropriate remediation. The SPCC plan will identify sources, locations and quantities of potential spills and response measures.

The operation of the plant is not anticipated to significantly affect land use. Operation of the IIFP facility has a SMALL impact on land use and does not require mitigative measures.

At the end of useful plant life, the IIFP facility will be decommissioned such that the site and remaining facilities may be released for unrestricted use. Process equipment will be removed; only building shells and the site infrastructure will remain. Remaining facilities will be decontaminated where needed to acceptable levels for unrestricted use. Therefore, land use impacts resulting from the decommissioning of the Proposed IIFP Facility are SMALL.

Overall, land use impacts to the site and vicinity are SMALL considering that the majority of the site will remain undeveloped and the placement of most utility installations along highway easements. IIFP is not aware of any federal action that would have cumulatively significant land use impacts. Except for the proposed construction of the IIFP facility, there are no other known current, future or proposed land use plans, including staged plans, for the site or immediate vicinity. Similarly, as the site is not subject to local or county zoning, land use planning or associated review process requirements, there are no known potential conflicts of land use plans, policies or controls.

8.3.2 Transportation Impacts

A construction and materials delivery access roadway off of north bound NM 483 will be built to support construction and delivery of materials to the site during construction. The access road would also serve as the personnel construction access road. The access roadway will eventually be converted to a permanent access road upon completion of construction. Therefore, impacts from access road construction will be minimized.

The U.S. 62/180 in the vicinity of the site serves as an east/west bound trucking route for the local area. The maximum potential increase to traffic due to construction and operational workers is 200 and 150 roundtrips per day, respectively. This is an upper bound estimate since the number of construction personnel will average 200 and operational workers do not all work on any given day. Operational shift changes for site personnel are estimated to average 20 to 30 vehicles per shift change. The maximum potential increase to traffic due to construction deliveries and waste removal is 17 roundtrips per day over

the site preparation and major building construction period. The condition and design basis for these roadways at the site are adequate to meet current traffic flow requirements and future minor changes to traffic patterns brought about by the construction and operation of the IIFP facility.

The increase in traffic on NM 483 during the construction and operation of the Proposed IIFP Facility will be 12% during each shift change. If all the traffic went east/west on U.S. 62/180, this will be less than 4% increase at Arkansas Junction at each shift change. The Proposed Action will have a SMALL to MODERATE impact on the transportation pattern from IIFP personnel. Generally, as the distance from the site increases, impacts to the transportation network decrease as traffic becomes more dispersed. On a regional basis, the cumulative transportation impacts for the Proposed IIFP Facility are expected to be SMALL.

The transportation impacts associated with decommissioning of the Proposed IIFP Facility will be temporary and variable over the decommissioning period for the IIFP facility. Given the significant reduction in the number of on-site workers, the level of expected truck traffic, and the relatively short duration for many of the expected decommissioning activities, the transportation impacts of the Proposed Action during decommissioning are anticipated to be SMALL.

The impact of the cumulative daily vehicle trips that will be generated by the Proposed IIFP Facility on traffic flow on the segment of U.S. 62/180 in the immediate vicinity of the Arkansas Junction is anticipated to be SMALL. However, the impact of cumulative daily vehicle trips on NM 483 is anticipated to be MODERATE. On a regional basis, the cumulative transportation impacts for the Proposed IIFP Facility are expected to be SMALL.

The radiological dose equivalents from incident-free transportation were calculated for the various material shipments to and from the IIFP site. Within each category, the worst-case dose equivalent for incident-free transportation was calculated and showed a SMALL impact.

The cumulative radiological or chemical (DUF_6) impacts of severe transportation accidents shipments are expected to be no greater than those evaluated in prior DOE and NRC Environmental Impact Statements See Section 4.6.2.4.

Similarly, the NRC has evaluated the environmental impacts resulting from the transport of nuclear materials in NUREG-0170, "Final Environmental Statement on the Transportation of Radioactive Material by Air and Other Modes" (NRC, 1977a), and updated by NUREG/CR-4829, "Shipping Container Response to Severe Highway and Railway Accident Conditions" (NRC, 1987a). These references include accident scenarios related to the transportation of radioactive material. The NRC found that these accidents have no significant environmental impacts (NRC, 1977a; NRC 1987a).

8.3.3 Geology and Soils Impacts

The Lea County Soils Survey describes soils found at the IIFP site as applicable for range, wildlife and recreation areas, and not for any standard agricultural activities. Construction and operation of the IIFP plant are thus not anticipated to displace any potential agrarian use.

Construction activities may cause some short-term increases in soil erosion at the site, although rainfall in the region is limited. Erosion impacts due to site clearing and grading will be mitigated by utilization of construction and erosion control BMPs. Disturbed soils will be stabilized as part of construction work. Earth berms, dikes and sediment fences will be utilized as necessary during all phases of construction to limit runoff. Much of the excavated areas will be covered by structures or paved, limiting the creation of

new dust sources. Watering will be used to control potentially fugitive construction dust. Water conservation will be considered when deciding how often dust suppression sprays will be applied.

Impacts to shallow soils after construction is complete and during Proposed IIFP Facility operation are expected to be SMALL. The new stormwater retention (evaporation) basins within the 40-acre IIFP facility site will manage any additional stormwater runoff. Operation of the Proposed IIFP Facility will not involve additional soil disturbances; therefore, additional areas susceptible to soil erosion and dust generation will not be created.

Decommissioning of the Proposed IIFP Facility will involve removal of internal structures, utilities, and products from the building; however, the physical structure, associated foundations, access roads, and utility lines will likely remain intact. Soil testing will also be integral to the process to demonstrate that any residual soil impacts, as compared to baseline soil-sampling to be conducted initially before construction, meet NRC and EPA guidelines. Impacts to shallow soils are expected to be SMALL upon completion of the decommissioning process.

8.3.4 Water Resources Impacts

Water resources at the site are minimal. The site sits upon the Ogallala Aquifer where groundwater resources are at depths greater than approximately 36.6 m (120 ft). The site region has semi-arid climate, with low precipitation rates and minimal surface water occurrence. Due to limited effluent discharge from the facility operations, the lack of groundwater in the sand and gravel layer above the Chinle Formation, and the considerable depth to groundwater at the IIFP site, the impacts are SMALL for groundwater at the site.

Industrial construction for the IIFP site will provide a short-term risk with regard to a variety of operations and constituents used in construction activities. These will be controlled by employing BMPs including control of hazardous materials and fuels. The stormwater retention basins for the site are designed to provide a means of controlling discharges of rainwater for about 20 to 25 acres of the IIFP site. Impacts to receiving waters from construction and operation of the IIFP facility are expected to be SMALL.

No wastes from facility operational systems will be discharged to stormwater. In addition, stormwater discharges during plant operation will be controlled by a Stormwater Pollution Prevention Plan (SWPPP). Impacts of operational activities to the surface and groundwater are expected to be SMALL.

Potable, process, and fire water for IIFP will be provided by on-site wells supplied from the Ogallala Aquifer. All potable water supply used at the IIFP facility will be treated. Average and peak site water requirements for all purposes are expected to be approximately 11.36 m³/day (3,000 gal/day) and 37.85 m³ /day (10,000 gal/day), respectively. These amounts correspond to 3.4 acre-feet and 11.2 acre-feet annually, respectively. Impacts to water resources on site and in the vicinity of the IIFP facility are SMALL.

Effluent discharges will be controlled in a way that will also prevent any impacts. The location of the closest municipal water system is in Hobbs, New Mexico, 16 miles east of the site. There is no potential to impact these users. Additionally, the IIFP water usage from the aquifer will not impact other users; therefore, the impacts are SMALL.

The existing groundwater monitoring program at the site will be supplemented with a focus on detecting any unforeseen impacts to groundwater quality associated with the Proposed Action, see Chapter 6,

“Environmental Measurement and Monitoring Programs.” Although there will be only a small potential for indirect impacts to groundwater quality, stormwater and effluent sampling will be conducted as necessary in accordance with the NPDES permit to protect surface water quality. In addition, site-wide groundwater levels will be monitored routinely, and the groundwater monitoring-well and pumping-well networks will be analyzed to confirm that the changes in groundwater levels associated with the Proposed Action are minimal. Thus, the impact of the Proposed Action on off-site groundwater quality and the effectiveness of the existing on-site pumping well system are SMALL.

Water discharged to the IIFP site sanitary waste treatment system will meet required levels for contaminants stipulated in any permit or license required for that activity. Therefore, the impact of the site sanitary waste treatment system is SMALL.

Sanitary and process wastewater effluent discharges will gradually decrease over the decommissioning phase as the processes and number of personnel in the Proposed IIFP Facility decrease. Stormwater will continue to be routed from the Proposed IIFP Facility to the stormwater retention basins during and after the decommissioning phase; therefore, no additional impacts will occur. The overall impact to surface water quality from the decommissioning phase is SMALL.

8.3.5 Ecological Resources Impacts

Several practices and procedures have been designed to minimize adverse impacts to the ecological resources of the IIFP site. These practices and procedures include the use of BMPs recommended by various state and federal management agencies, minimizing the construction footprint to the extent possible, the use of retention basins, the protection of undisturbed naturalized areas, and site stabilization practices to reduce the potential for erosion and sedimentation. Based on recommendations from the New Mexico Department of Game and Fish, basins will be fenced to exclude wildlife and the basin surface areas netted, or other suitable means utilized, to minimize the use of process basins by birds and waterfowl. The use of native plant species in disturbed area revegetation will enhance and maximize the opportunity for native wildlife habitat to be reestablished at the site.

The area of land to be disturbed is approximately 40 acres. This area includes 5 acres that will be used for contractor parking and lay-down areas. The contractor lay-down and parking area will be restored after completion of plant construction. Approximately 7% of the total 640-acre Section area will be disturbed affording wildlife of the site an opportunity to move to undisturbed on-site areas as well as additional areas of suitable habitat bordering the IIFP site. Indirect impacts to wildlife during construction may include increased noise, disruption of travel corridors, and behavioral modifications. Wildlife on the site are adapted to current conditions, which include roads used by the oil/gas industry personnel that fragment the site, loud noises from pumping at the oil/gas rigs, and irregular travel of vehicles on existing roads. Overall, wildlife populations on the Proposed Site will be altered but will not be destabilized; therefore, direct and indirect impacts to wildlife are MODERATE.

The operation of the Proposed IIFP Facility will not directly impact additional biotic communities beyond those impacted during the site preparation and construction phases. Fencing around the Proposed IIFP Facility could cause additional disruption of wildlife travel corridors. However, wildlife could develop new travel corridors and utilize the fence line and the new road as corridors. Human encounters with some wildlife could increase due to disruption of travel corridors and loss of habitat. Operation of the Proposed Action will not noticeably alter the impact to biotic communities or wildlife. Impacts to travel corridors and habitat quality are anticipated to be SMALL.

Non-radiological air emissions from the IIFP facility will be less than the National Ambient Air Quality Standards (NAAQS) for humans (see Section 4.6, Air Quality Impacts); however, emissions from vehicles and very small emissions from the operation of the facility will occur and could have small impacts to wildlife. No rare or unique habitats will be directly affected by the operational phases of the Proposed Action; therefore, overall indirect impacts from non-radiological air emissions are SMALL.

Emission stacks are proposed to be less than 30.5 m (100 ft) tall. Emission stacks are well under the 61 m (200 ft) threshold that requires lights for aviation safety. This avoidance of lights, which attract species, and the low above ground level structure height, also reduces the relative potential for impacts. Additionally, security lighting for all ground level facilities and equipment will be directed downward to help to reduce the potential for impacts (USFWS, 1998). The impacts of elevated construction equipment or structures to the ecological species are SMALL.

Decommissioning activities will occur within the limits of the Proposed IIFP Facility established during operations. Landscape areas and maintained lawn areas established at the completion of the construction phases could be impacted during the decommissioning process. Disturbed areas will be re-planted in accordance with the regulations at the time of decommissioning. Impacts from possible radiological exposure will be similar to or less than exposure during the operation phase. The Decommissioning Plan regulations by the NRC and EPA minimize impacts to humans and, as a result, also afford protection to ecological resources. Overall impacts to wildlife and biotic communities from the decommissioning of the Proposed IIFP Facility are SMALL.

8.3.6 Air Quality Impacts

Air quality impacts resulting from the Proposed IIFP Facility will be controlled by implementing a comprehensive program that incorporates the following air emissions-control components:

- Process design features to inherently lower the potential for air emissions
- Air emissions control systems to capture and remove air pollutants
- Monitoring and inspection programs to detect any air emissions from equipment malfunction so that corrective action can be taken promptly
- Work practices to prevent or reduce air emissions releases.

The results of air modeling show that annual average and short-term ambient air concentrations from fugitive dust and on-site motor vehicle emissions produced by construction activities for the Proposed IIFP Facility will be orders of magnitude below the level of the applicable ambient air quality standards. These incremental air quality impacts from the air emissions from preparation of the IIFP facility site and construction of the facility will not measurably change the existing ambient air quality in the vicinity of the Proposed IIFP Facility; therefore, the air quality impacts resulting from the construction of the Proposed IIFP Facility are SMALL.

The EPA uses six criteria pollutants as indicators of air quality. Concentrations above maximum concentrations may cause adverse effects on human health. Areas either meet the national primary or secondary air quality standards for criteria pollutants (attainment) or do not meet the national primary or secondary air quality for the criteria pollutants (nonattainment). The criteria pollutants are ozone, carbon monoxide, nitrogen dioxide, sulfur dioxide, particulate matter and lead. According to information from the EPA, Lea County is in attainment for all criteria pollutants. The incremental air quality impacts from operation of the Proposed IIFP Facility will not measurably change the existing ambient air quality in the vicinity of the Proposed IIFP Facility; therefore, the air quality impacts that will result from the Proposed IIFP Facility operations are SMALL.

The number of on-site workers required during the decommissioning of the Proposed IIFP Facility is projected to decrease to approximately 40 workers. Truck traffic for the decommissioning phase will depend on the amounts of equipment, materials, and demolition debris to be removed and the individual destinations to which these materials are shipped. Automobile and truck air emissions for the Proposed IIFP Facility decommissioning phase are expected to be lower than those estimated for the construction and operation phases because of lower-emitting motor vehicles being used at that time as a result of more stringent federal emission standards in effect and new mobile vehicle technologies. Thus, the air quality impacts that will result from the Proposed IIFP Facility decommissioning will be SMALL.

Air emissions of the pollutants that contribute to haze formation are predicted to be low from the on-site air emission sources associated with the Proposed IIFP Facility pre-licensing and general construction, operation, and decommissioning phases. Consequently, the air emissions from the Proposed IIFP Facility are expected to have no measurable impact on regional visibility; therefore, the visibility impacts resulting from the pre-licensing and general construction, operation, and decommissioning of the Proposed IIFP Facility will be SMALL.

8.3.7 Noise Impacts

The IIFP facility will be built on 12.6 ha (40 ac) approximately in the center of the 259 ha (640 ac) Section. The site is bounded on the south by U.S. 62/180 and on the west by NM 483. Considering that the sound pressure level from an outdoor noise source decreases 6 decibel units (dB) per doubling of distance, the highest noise levels are predicted to be within the range of 50 dBA to 65 dBA at the 640-acre property boundary lines during construction.

The predicted noise level ranges from the construction of the IIFP facility fall within acceptable sound pressure levels as determined by the U.S. Department of Housing and Urban Development. U.S. 62/180 is a main trucking thoroughfare for local industry on the south boundary and that there are no other sensitive receptors at the IIFP south boundary. In addition, noise levels in the predicted ranges at the south boundary and the west boundary would only be for a short duration and only during construction of the facilities. Xcel Energy Cunningham Generating Station is located on NM 483 on the western boundary of the IIFP site, while Xcel Energy Maddox Generation Station and Colorado Energy Generation Station are located east and northeast of the site, respectively. The DCP Midstream Linam Ranch Plant gas facility is located on U.S. 62/180 southeast of the IIFP site. Due to the temporary and episodic nature of construction, and because of the significant distance to the nearest residence approximately 8.5 km (5.3 mi) to the northeast of the site, and since construction activities largely would be during weekday daylight hours, actual construction noise at the site is not expected to have a significant effect on nearby residents.

After the road construction and preparation of the IIFP facility site are complete, there will be a lower average sound level while the buildings are erected. The building activities are likely to generate short duration noises, resulting from hauling equipment and handling or moving construction materials, which are typical of building construction. Smaller construction vehicles will be used around the building construction site. Traffic accessing the construction site will increase, but the traffic will consist of smaller passenger or sport utility vehicle/pick-up truck-type vehicles, which are estimated to have a SMALL noise impact to the area.

Noise point sources for the plant during operation will include: reaction vessels, coolers, rooftop fans, air conditioners, transformers, and traffic from delivery trucks, employee and site vehicles. Noise line sources for the plant during operation will consist only of site vehicular traffic entering and leaving the site. Ambient background noise sources in the area include vehicular traffic along U.S. 62/180 and NM 483, low flying aircraft traffic from the Hobbs Regional Airport, and neighboring industrial facilities.

Since the nearest known residence is located northeast of the IIFP site at a distance of approximately 8.5 km (5.3 mi), the resultant sound level exposure will be below the perception of the human ear. This is because a noise source over such a great distance will be dispersed in air and absorbed by natural landscape, vegetation, and buildings to the point of being masked by background ambient noise at the receptor.

For operational noise exposure to the nearest residence located northeast of the IIFP site at a distance of approximately 8.5 km (5.3 mi), the resultant sound level exposure would generally be below the perception of the human ear. Certain phases of operation, weather, time of day, wind direction, traffic patterns, season, and the location of the receptor will all impact perceived operational noise levels. Although the noise from the plant and the additional traffic would generally be noticeable, the operational noise is not expected to have a significant impact on nearby traffic or the surrounding industries. Thus, noise impacts from the operation of the IIFP facility are SMALL.

Mitigation of operational noise sources will occur primarily from the plant design, as reaction vessel systems, valves, transformers, pumps, generators, and other facility equipment, will generally be located inside plant structures. The buildings themselves will absorb the majority of the noise generated within. Natural land contours, vegetation (such as scrub brush and trees), and site buildings and structures will mitigate noise from other equipment located outside of site structures. Distance from the noise source is also a key factor in the control of noise levels to area receptors. However, heavy truck and earth moving equipment usage will be restricted after twilight and during early morning hours. Noise suppression systems on construction vehicles will be kept in proper operation.

Decommissioning of the Proposed IIFP Facility will produce sound levels similar to or lower than those generated from the IIFP facility site preparation and construction activities. The majority of activities will involve decontaminating and deconstructing facility equipment and hauling the materials off site. As a result, the majority of the noise impacting the community will relate to the noise of hauling traffic. The anticipated noise emissions will be similar to those during the facility construction phases and are therefore estimated to represent a SMALL noise impact.

The level of noise anticipated off site is comparable to noise levels near a busy road and less than noise levels found in most city neighborhoods. Expected noise levels will mostly affect a 1.6-km (1-mi) radius. The cumulative noise of all site activities should have a SMALL impact and to only those receptors closest to the site boundary.

8.3.8 Historic and Cultural Resource Impacts

The region surrounding the proposed IIFP site in southeastern New Mexico and Western Texas is rich in prehistoric and historic American Indian and Euro-American history. This local setting, which occurs well onto the Llano Estacado, is a flat, treeless plain lacking nearby permanent or semi-permanent surface water. As a result, the proposed IIFP site was not conducive to extensive human use over the centuries. In contrast to the proposed IIFP site area, shelter and other resources were more readily available at selected locales elsewhere on the Llano Estacado where temporary and some permanent springs and lakes were found.

The isolated occurrences discovered during a pedestrian cultural resource survey of the site have been completely recorded in a manner consistent with current standards and do not require any additional work. No previously recorded cultural resources sites within 1 km (0.62 mi) of the project area. The absence of cultural resources in the site area may be explained by the presence of shallow sediments with exposed caliche (indicating a lack of lithic raw materials), and a lack of permanent water sources. This

may have made the location unattractive to prehistoric peoples. No other discoveries were made. The proposed IIFP undertaking is not expected to impact cultural resources.

There is low potential for human remains to be present on the IIFP site. Based on previous work in the region, burials tend to occur in rock shelters and on sites with structures. Should an inadvertent discovery of such remains be made during construction, IIFP will stop construction activities immediately in the area of discovery and notify the New Mexico State Historic Preservation Officer (SHPO). The construction activity will resume only after the appropriate consultations and notifications have occurred and guidance received.

If any eligible historic properties are located within the Area of Potential Effect (APE) of the proposed location of the IIFP facility, a treatment/mitigation plan will be developed to recover any significant information from any eligible archaeological sites identified on the IIFP site. Mitigation measures will be in place to minimize any potential impact on historical and cultural resources. In the event that any inadvertent discovery of human remains or other item of archeological significance is made during construction, the facility will cease construction activities immediately in the area of discovery and notify the New Mexico SHPO to make the determination of appropriate measures to identify, evaluate, and treat these discoveries.

Given the small number of potential archaeological sites and IIFP's ability to avoid or mitigate impacts to those sites, the IIFP project will have a SMALL impact on historic and cultural resources.

8.3.9 Visual/Scenic Resources Impacts

The visual resource inventory process provides a means for determining visual values (BLM, 1984). The inventory consists of a scenic quality evaluation, sensitivity level analysis, and a delineation of distance zones. The IIFP site, as preliminarily evaluated based on the scenic quality of the site falls into a class is of the least value and allows for manipulation or disturbance. The proposed use of the IIFP site is not outside the objectives of the class which is to provide for management activities that require major modifications of the existing character of the landscape. Therefore, land management activities may dominate the view and be the major focus of viewer attention. The level of change to the characteristics of the landscape can be high.

Although the proposed IIFP structures will be located a substantial distance from U.S. 62/180 and NM 483, due to the relative flatness of the area, taller plant structures 21.3 m (70 ft) will likely be visible from the highway and adjacent properties, creating a visual intrusion. However, considering the existing structures associated with neighboring power generation stations to the west, east, and southeast the nearby utility poles along U.S. 62/180 and NM 483, the high power utility lines running through the site parallel to the U.S 62/180 and across NM 483 running to the southwest, and the numerous pump jacks dotting the landscape all around the site as well as industrial structures, man-made earthen structures, caliche-covered roadways, the proposed on-site structures will be no more intrusive.

Given that the site is undeveloped, the Proposed IIFP Facility is not out of character with current, on-site conditions. However, considering the neighboring properties have been developed for industrial purposes (three power generating companies), the proposed plant structures are similar to existing, architectural features on surrounding land. Overall, the visual impact of the IIFP plant will be minimal.

Mitigation measures will be in place to minimize the impact to visual and scenic resources. These include the following items:

- Accepted natural, low-water consumption landscaping techniques will be used to limit any potential visual impacts. These techniques will incorporate, but not be limited to, the use of landscape plantings. As for aesthetically pleasing screening measures, planned landscape plantings will include indigenous vegetation.
- Prompt re-vegetation or covering of bare areas will be used to mitigate visual impacts due to construction activities.

8.3.10 Socioeconomic Impacts

Pre-licensing constructions at the IIFP site is scheduled for early 2011, with general construction continuing 20 to 24 months into 2012. A peak construction force of about 200 workers is anticipated during the period 2011-2012.

The IIFP annual operating payroll will be approximately \$7.9-\$9.1 million for a workforce of approximately 120-135 in Phase 1. The operational costs for the IIFP facility are about \$28.5 million per year as expressed in 2009 dollars. Phase 2 payroll will be approximately \$9.5 -\$10.5 million for a workforce of approximately 145-160. The operational costs for Phase 2 are estimated at approximately \$44 million annually (in 2009 dollars).

This minor increase in population would produce a minor impact on population characteristics, economic trends, housing, community services (health, social and educational resources), and the tax structure and distribution within 120 km (75 mi) of the site during both the construction and operation periods.

The major impact of facility construction on human activities is expected to be a result of the influx of labor into the area on a daily or semi-permanent basis. IIFP estimates approximately 15% of the construction work force (200 workers average) is expected to move into the vicinity as new residents. Previous experience regarding construction for the nuclear industry projects suggests that of those who move, approximately 65% will bring their families, which on average consist of the worker, a spouse, and one school-aged child (NRC, 1994a). The likely increases in area population during construction, therefore, will total 70. This is less than 0.1% of the total Lea County, New Mexico and Andrews/Gaines counties in Texas 2000 population.

Operation of the proposed IIFP plant would lead to a permanent increase in employment, income, and population in the area. Employment at the IIFP facility during operation will be a maximum of 150 workers. This is less than a 0.5% increase in total employment in Lea, Andrews, and Gaines Counties and approximately a 10% increase in manufacturing employment in the three counties, as compared to the latest census estimate of jobs. A significant number of operational jobs are likely to be filled by residents in the region since most of its populace has completed school attainment at the high school grade level.

An increase in the number of jobs would also lead to a population increase in the surrounding areas. Lea and Gaines Counties probably would experience the most noticeable population increases. However, these increases would be less than during facility construction and, accordingly, have commensurately lesser impacts. In particular, the region would avoid a boomtown effect, which generally describes the consequence of rapid increases in population from a major city or communities undergoing rapid increases in economic activity (NRC, 1994). The overall change in population density and population characteristics in Lea County, New Mexico and Andrews/Gaines Counties, Texas due to operation of the IIFP facility will be insignificant.

In general, no significant impacts are expected to occur for any local area infrastructure (e.g., schools, housing, water, and sewer). Costs of operation should be diffused sufficiently throughout the Hobbs, New Mexico area to be indistinguishable from normal economic growth.

8.3.11 Environmental Justice

Based on an analysis of minority and low-income census block groups, IIFP has concluded that disproportionately high minority or low-income populations exist that warrant further examination of environmental impacts upon such populations. The Environmental Impact Study conducted by the NRC for the National Enrichment Facility (NEF) in nearby Eunice, Texas (NRC, 2005) conducted additional examination of environmental impacts upon the same populations. For each of the areas of technical analysis presented in that EIS, the review of impacts to the human and natural environment was conducted to determine if any minority or low-income populations could be subject to disproportionately high and adverse impacts from the Proposed Action. That review included potential impacts from the construction and operation of the proposed NEF.

Examination by NRC of the various environmental pathways by which low-income and minority populations could be disproportionately affected revealed no disproportionately high and adverse impacts from either construction or normal operations of the proposed NEF. In addition, no credible accident scenarios exist in which such impacts could take place. Similar conclusions would be drawn for the IIFP facility to be built 21 miles from the NEF.

Because the Census Block Groups (CBG) in which the facility is located has no minority and low-income residents within a 4-mile radius (50 mi²) of the plant, pre-licensing and general construction, operation, and decommissioning of the facility is not expected to result in disproportionately high or adverse impacts on minority or low-income populations. No environmental justice concerns are expected from the construction, operation, and decommissioning of the Proposed IIFP Facility. Environmental justice impacts are SMALL.

8.3.12 Public and Occupational Health Impacts

The primary material in use at the facility is uranium hexafluoride (UF₆). UF₆ is hygroscopic (moisture absorbing) and, in contact with water, will chemically break down into uranyl fluoride (UO₂F₂) and hydrogen fluoride (HF). When released to the atmosphere, gaseous UF₆ combines with humidity to form a cloud of particulate UO₂F₂ and HF fumes. Inhalation of UF₆ typically results in internal exposure to UO₂F₂ and HF. In addition to a potential radiation dose, a worker would be subjected to two other primary toxic effects:

- Uranium in the uranyl complex acts as a heavy metal poison that can affect the kidneys, and
- HF can cause severe irritation to the skin and lungs at high concentrations.

Because of low specific-activity values, the radio-toxicity of UF₆ and its products are smaller than their chemical toxicity.

Of primary importance to IIFP is the control of UF₆. The UF₆ readily reacts with air, moisture, and some other materials. The most significant reaction products in this plant are HF, UO₂F₂, SiF₄, BF₃, and small amounts of uranium tetrafluoride (UF₄). Of these, HF is the most significant hazard, being toxic to humans.

Worker exposure to in-plant gaseous effluents will be minimal. No exposures exceeding 29 CFR 1910, Subpart Z are anticipated (CFR, 2009g). Laboratory and maintenance operations activities involving hazardous gaseous or respirable effluents will be conducted with ventilation control (i.e., fume hoods, local exhaust or similar) and/or with the use of respiratory protection as required.

Additionally, worker exposure to liquid in-plant effluents will be minimal. No exposures exceeding 29 CFR 1910 (CFR, 2009g), Subpart Z are anticipated. Additionally, handling of all chemicals and wastes will be conducted in accordance with the site Environment, Health, and Safety Program which will conform to 29 CFR 1910 (CFR, 2009g) and specify the use of appropriate engineered controls, as well as personnel protective equipment, to minimize potential chemical exposures.

Routine operations at the IIFP facility create the potential for radiation exposure to plant workers, members of the public, and the environment. Workers at the IIFP facility are subject to higher potential radiation exposures than members of the public because they are involved directly with handling depleted UF₆ cylinders, processes handling DUF₆, DUF₄, and DU₃O₈, storage of DUF₄ and depleted uranium oxides, and decontamination of containers and equipment. In addition to the radiological hazards associated with uranium, workers may potentially be exposed to the chemical hazards associated with uranium. However, workers at the IIFP facility are protected by the combination of the implementation of a Radiation Protection Program and a Health and Safety Program.

Members of the general public also may be subject to potential radiation exposure due to routine operations at the IIFP facility. Public exposure to plant-related uranium may occur as the result of gaseous and liquid effluent discharges and transportation of UF₆, and uranium oxides and storage of UF₆, UF₄, and uranium oxides. In each case, the amount of exposure incurred by the general public is expected to be very low. Engineered effluent controls, effluent sampling, and administrative limits, are in place to assure that any impacts on the health and safety of the public resulting from routine plant operations are maintained as low as reasonably achievable (ALARA). The effectiveness of the effluent controls will be confirmed through implementation of the Radiological Environmental Monitoring Program.

Occupational injury rate at the IIFP plant is expected to be better than the industry average owing to the commitment that IIFP is making in a safe design basis for facilities and programs. IIFP senior management commitment to safety is evident by its safety experience at its existing Idaho Falls facility and the recognition it has received. Common occupational accidents at uranium plants similar to the proposed IIFP plant typically involve hand and finger injuries, tripping accidents, minor burns and impacts due to striking objects or slips/falls.

The operation of the proposed IIFP plant would involve risks to workers, the public and the environment from potential accidents. IIFP has evaluated the consequences of potential accidents identified in the Integrated Safety Analysis (IIFP, 2009). The accidents evaluated are a representative selection of the types of accidents that are possible at the proposed IIFP site.

The analytical methods used in this consequence assessment are based on NRC guidance for analysis of nuclear fuel-cycle facility accidents (NRC, 1998a). The hazards evaluated involve the release of UF₆ vapor from process systems that are designed to confine UF₆ during normal operations. IIFP has committed to various preventive and mitigation measures to significantly reduce these risks.

The potential for injuries and fatalities of workers exists during project construction and operation. Engineered controls, precautions, training, safety programs, and management measures will reduce the potential for worker injuries or fatalities.

Radiation and chemical releases from operations, in general, may cause adverse impacts. However, the releases and corresponding exposures from the IIFP facility would be well below regulatory limits and proportionally very small. In addition, IIFP would use safety procedures, spill prevention plans, and spill response plans in accordance with State and federal laws to avoid and investigate accidental spills or leaks.

Implementation of both a radiation protection program and a health and safety program will protect workers at the IIFP facility. The Radiation Protection Program will comply with all applicable NRC requirements established in 10 CFR 20 (CFR, 2009a), Subpart B. Similarly, the Health and Safety Program at the IIFP plant will comply with applicable OSHA requirements established in 29 CFR 1910 (CFR, 2009g).

Although routine operations at the IIFP plant create the potential for radiological and nonradiological impacts on the environment and members of the public, plant design has incorporated features to minimize gaseous and liquid effluent releases and to keep them well below regulatory limits. These features include:

- DUF₆ cylinders are moved only when cool and when DUF₆ is in solid form, which minimizes the risk of inadvertent release due to mishandling.
- Process off-gas from DUF₆ purification and other operations passes through de-sublimers to solidify and reclaim as much DUF₆ as possible. Remaining gases pass through high-efficiency filters and chemical absorbers, which remove HF and uranium compounds.
- Liquid and solid waste handling systems and techniques are used to control wastes and effluent concentrations.
- Effluent paths are monitored and sampled to assure compliance with regulatory discharge limits.

8.3.13 Waste Management Impacts

Solid waste generated at the IIFP plant will be grouped into industrial (nonhazardous), radioactive and mixed, and hazardous waste categories. In addition, solid radioactive and mixed waste will be further segregated according to the quantity of liquid that is not readily separable from the solid material. The solid waste management systems will be in designated areas, administrative procedures, and practices that provide for the collection, temporary storage, (no solid waste processing is planned), and preparing for off-site disposal of categorized solid waste in accordance with regulatory requirements. Solid radioactive wastes generated will be low-level wastes (LLW) as defined in 10 CFR 61 (CFR, 2009a). See Table 8-1, “Estimated Annual Quantities of Waste Generated at the IIFP Facility.”

Table 8- 1 Estimated Annual Quantities of Waste Generated at the IIFP Facility

Material	Phase 1 (lb)	Total Phase 1 and Phase 2 (lb)
Depleted uranium oxide including drums	2,800,000-6,000,000	8,700,000-18,000,000
Other process LLW	42,000-68,000	45,500-73,000
Misc, LLW	35,000-55,000	70,000-100,000
RCRA	32,300-361,500*	45,500-174,000*
Industrial waste including sanitary waste	71,000-108,500	85,400-135,000

*Includes Calcium Fluoride which if not sold may be RCRA Waste.

The depleted uranium oxide waste from the de-conversion process is shipped to an off-site LLW disposal facility licensed for accepting depleted uranium oxide.

Industrial waste, including sanitary waste, miscellaneous trash, vehicle air filters, empty cutting oil cans, miscellaneous scrap metal, and paper will be shipped to off-site facilities for recycle or minimization, and, then sent, if required, to a licensed waste disposal facility.

Radioactive waste, including dust collector bags, ion exchange resin, crushed-contaminated drums, contaminated trash, contaminated coke-material and carbon-bed trap material will be collected in labeled containers in each Restricted Area and transferred to a temporary radioactive waste storage area for inspection. Suitable waste will be volume-reduced, if appropriate, and radioactive waste will be disposed at a licensed LLW disposal facility.

Hazardous wastes and some mixed wastes will be generated at the IIFP site. These wastes will also be collected at the point of generation, transferred to a temporary waste storage area, inspected, and classified. Any mixed waste that may be processed to meet land disposal requirements may be treated in its original collection container and shipped as LLW for disposal at a licensed facility.

Resource Conservation and Recovery Act (RCRA) hazardous wastes will be collected and packaged in approved containers and shipped by a licensed RCRA transporter and sent to licensed RCRA disposal facility. Under New Mexico regulations, a facility that generates more than 1,000 kg (2,200 lb) per month is a large quantity generator of RCRA wastes. In New Mexico, hazardous waste generators are classified by the actual monthly generation rate, not the annual average.

There is no on-site disposal of any solid or liquid waste at the IIFP facility. Waste management impacts for on-site disposal, therefore, are not evaluated.

The facility does not directly discharge any process effluents to natural surface waters or grounds onsite, and there is no tie into a Publicly Owned-Treatment Works (POTW). No public impact is expected from routine liquid effluent discharge as no process liquids are discharged offsite (process wastes are recycled).

Worker exposure to liquid in-plant effluents is minimal. No exposures exceeding 29 CFR 1910, (CFR, 2009b) Subpart Z is anticipated. Additionally, handling of all chemicals and wastes is conducted in accordance with the site Environment, Health, and Safety Program, which conforms to 29 CFR 1910 and specifies the use of appropriate engineered controls, as well as personnel protective equipment, to minimize potential chemical exposures.

Process effluents are treated and recycled or reused within the processes. Relatively small amounts of aqueous and non-aqueous liquid waste generation can be expected. These miscellaneous materials are collected in approved containers. Solutions containing uranium may be sent to the Decontamination Building for removal of the uranium followed by evaporation of the treated water. Aqueous laboratory samples and other miscellaneous liquids from maintenance activities that may contain uranium are sampled to determine their uranium or hazardous waste content, collected in approved containers and sent to a licensed disposal facility appropriate for that type hazardous material, if applicable. Where potentially contaminated areas have to be cleaned with solutions, the solution, if contaminated, is sent to the Decontamination Building to remove uranium, evaporate the liquids, and package any uranium residues for shipment to an off-site licensed disposal facility.

Non-process waste liquids that are determined to contain regulated or hazardous contaminants are collected and disposed at an off-site licensed facility. Cooling water is recycled and steam condensate is either reused as process makeup water or treated and returned to the boiler.

A retention basin is used for the collection and monitoring of general site storm water runoff.

Sanitary sewage effluent is discharged into a package treatment unit where it will receive primary, secondary and tertiary treatment. Treated sanitary water is either reused in plant processes or for landscape watering.

The highest priority has been assigned to minimizing the generation of waste through reduction, reuse or recycling. The IIFP plant is designed to minimize the usage of natural and depletable resources. Water is the primary depletable resource used at the facility. Closed-loop cooling systems have been incorporated in the designs to reduce water usage. Electric power usage also depletes fuel sources used in the production of the power. Power usage will be minimized by efficient design of lighting systems, selection of high-efficiency motors, and use of proper insulation materials. Chemical usage is optimized, not only to conserve resources, but also to preclude excessive waste production. Recyclable materials are used and recycled wherever practicable.

ALARA controls will be maintained during facility operation to account for standard waste minimization practices as directed in 10 CFR 20 (CFR, 2009a). The outer packaging associated with consumables will be removed prior to use in a contaminated area to minimize the spread of contamination and waste generation.

8.4 Relationship Between Short-Term Use of The Environment and The Maintenance and Enhancement of Long-Term Productivity

Consistent with the definitions established in Section 5.8 of NUREG-1748 (NRC, 2003), the terms “short-term uses” and “long-term productivity” are defined as follows:

- “Short-term uses” generally affect the present quality of life for the public (i.e., the planned license period for the Proposed IIFP Facility)
- “Long-term productivity” affects the quality of life for future generations based on environmental sustainability (i.e., the period after license termination for the Proposed IIFP Facility).

The plant would be consistent with local, State, and federal plans and permits. The short-term impacts and use of resources for the proposed plant as identified in Section 8.3 also would be consistent with the maintenance and enhancement of long-term productivity for New Mexico.

The pre-licensing and general construction, operation, and decommissioning of the Proposed IIFP Facility would require short-term uses of environmental resources that would have a SMALL impact on the quality of life for the public. Impacts on the public from the short-term use of these environmental resources for the Proposed Action would be controlled and minimized to the extent practicable with the implementation of mitigation measures and good resource management practices.

The Proposed IIFP Facility would be constructed on land already owned by the State. No identified cultural or historical resources would be impacted by the Proposed Action. The facility would create no visual/resource impacts that are out of character with the industries with the vicinity of the site, or alter its existing mixed land use setting. Potential impacts from geological conditions on the Proposed IIFP Facility are SMALL and mitigated through engineering controls.

Water-quality impacts from construction activities and operation of the Proposed Action would be SMALL due to the use of best management practices, as described in Chapters 4 and 5, and standard waste treatment operations. The Proposed Action does not use surface water as a source of water. Any impacts from the Proposed Action on groundwater quality are SMALL. Groundwater levels are not anticipated to change significantly in response to water usage required for the Proposed Action; therefore, water consumption by the Proposed IIFP Facility would not notably impact the supply of water to other users in the area.

Construction and operation of the Proposed IIFP Facility and proposed access road would displace some local wildlife populations to nearby habitat and disrupt wildlife travel corridors. Human encounters with some wildlife could increase due to disruption of travel corridors and loss of habitat. No direct impacts to rare or unique habitats or commercially or recreationally valuable species would result from the Proposed Action. Overall, the Proposed Action will not noticeably alter the impact to biotic communities or wildlife, and the existence of these species would not be destabilized. Therefore, direct and indirect impacts to ecological resources from the Proposed Action are SMALL.

Workers at the Proposed IIFP Facility would use appropriate safety equipment and procedures to limit to acceptable levels any radiation and chemical exposure that would occur during certain material-handling and maintenance activities required for operation of the uranium de-conversion process. During construction, operation, and decommissioning of the Proposed IIFP Facility, air emissions control systems, monitoring programs, and BMPs would be used to limit the amounts of air pollutants released to the atmosphere so as to not significantly affect the ambient air concentration levels to which the public is exposed. Solid wastes would be managed on site in accordance with good waste storage and handling practices and shipped for recycling, re-use, or final treatment or disposal at licensed facilities appropriate for the waste type.

Overall population, economic, and social adverse impacts from the Proposed IIFP Facility are anticipated to be SMALL. The numbers of workers required for construction, operation, and decommissioning of the Proposed IIFP Facility are expected not to significantly affect housing, educational, medical, law enforcement, and fire services in the region. The Proposed Action is not expected to result in disproportionately adverse impacts on low-income or minority residents.

Motor vehicle traffic generated by the construction and operation of the Proposed IIFP Facility could increase traffic congestion during certain times of the day on NM 483 for the 1-1/2 mile stretch between Arkansas Junction and the site access road, creating MODERATE impacts, but overall transportation impacts would be SMALL on a regional basis. No residents will be impacted by noise during initial site preparation and construction activities for the Proposed IIFP Facility. Because most noise-generating sources associated with operation of the Proposed IIFP Facility would be located inside structures, noise impacts for the remainder of the operating life of the Proposed IIFP Facility would be SMALL.

The pre-licensing and general construction, operation, and decommissioning of the Proposed IIFP Facility would permanently consume materials and energy resources that would no longer be available for use by future generations. Upon the permanent closure of the Proposed IIFP Facility, IIFP would decontaminate and decommission the buildings and equipment.

The construction and operation of the Proposed IIFP Facility would require the short-term commitment of resources and would permanently commit certain resources (e.g., land, energy, construction materials) to the facility's construction and operation. The short-term use of such resources would result in the long-term socioeconomic benefits to the local area and the region through continued (and incremental) employment and expenditures as described in Section 4.10. Long-term productivity would be facilitated

by investment in dependent businesses in the local area and region and would provide further socioeconomic benefits to the local area and the region.

8.5 No-Action Alternative

The following types of impacts would be avoided in Lea County, New Mexico and the surrounding area by the No-Action Alternative. During construction activities, the short-term impacts that would be avoided by the No-Action Alternative include the potential soil erosion and fugitive emissions from dust and construction equipment; minor disruption to ecological habitats and cultural resources, noise from equipment; and traffic from worker transportation and supply deliveries. During operation, the No-Action Alternative that would be avoided includes increased traffic due to feed/product deliveries and shipments; worker transportation; increased demand on utility and waste services; and public and occupational exposure from effluent releases.

While the No-Action Alternative would have no impact on the socioeconomic structure of the Lea County, New Mexico area, the Proposed Action would have moderate to significant beneficial effects. See Table 7-2, “Summary of Capital Cost Estimate for Phase 1 FEP/DUP Facility,” and Table 7-5, “Phase 1 Plant Estimated Labor for Plant Personnel.” The results of the economic analysis show that the greatest fiscal impacts (i.e., 63% of total present value impacts) will be derived from the 20-24 month construction period associated with the proposed facility. The largest impact on local business revenues stems from local construction expenditures, while the most significant impact on household earnings and jobs is associated with construction payroll and employment projected during the construction period. Operation of the facility will also have a net positive impact on the nine-county area and will help diversify the regional economy and provide some additional insulation from the volatility of the oil and gas dependent economy of the region.

IIFP has estimated the economic impacts to the local economy during the construction period and the indefinite operating license period of the IIFP facility. The analysis traces the economic impact of the Proposed IIFP Facility, identifying the impacts of the plant on revenues of local businesses, on incomes accruing to households, on employment, and on the revenues of state and local government. The analysis also explores the indirect impacts of the IIFP facility within an 80-km (50-mi) radius of the Site. Details of the analysis are provided in ER Section 7.1, “Economic Cost-Benefits, Plant Construction and Operation,” and are summarized below.

IIFP estimates that the capital costs for the construction of the facility will total approximately \$112 to \$151 million for Phase 1 plus Phase 2 construction. IIFP anticipates annual operations payroll to be approximately \$7.9 to \$9.1 million for Phase 1 and approximately \$9.6 to \$10.5 million after Phase 2 operation begins. The annual operating costs for the IIFP facility are about \$28.5 million and up to \$44 million once Phase 2 is completed (expressed in 2009 dollars).

8.6 Reasonable Alternative Actions

Reasonable Alternatives were considered in comparison to the Proposed Action. One Reasonable Alternative considered includes other commercial enrichment plants constructing their own de-conversion facilities using their own technologies with impacts expected to be SMALL to MODERATE, depending upon the site-specific conditions. If those companies build new facilities to de-convert “tails” material, it is expected that the land use impacts for this Reasonable Alternative are greater than the Proposed Action, if aqueous HF generated by this alternative is not marketable or sold. This potentially greater impact is due to the difference in technologies that produce aqueous HF and in the treatment and generation of CaF₂ waste if it cannot be sold.

Another Reasonable Alternative is that two of the enrichment companies have de-conversion facilities overseas, and they could choose to ship their DUF₆ from the U.S. to their facilities for de-conversion. This alternative would require the other two enrichment companies in the U.S. to rely upon the No-Action Alternative or the Reasonable Alternatives stated in previous paragraph.

Those companies that have existing overseas facilities and technologies would be required to ship DUF₆ overseas long-distances and may have to return the waste oxides to the United States for licensed disposal or may have to arrange with other countries for disposal. It is expected that transportation impacts for this option of shipping the DUF₆ overseas may be greater than the Proposed Action. If those companies were to use their own technologies, it is expected that the aqueous HF, if not sold, would result in larger impacts than the Proposed Action.

8.7 Conclusion

Based on the cost-benefit analyses in ER Sections 7.1 and 7.2, and the minimal impacts to the affected environment demonstrated in Chapter 4, IIFP has concluded that the preferred alternative is the Proposed Action, construction and operation of the Proposed IIFP Facility.

9. LIST OF REFERENCES

ACGIH, 2000. American Conference of Governmental Industrial Hygienist, “Threshold Level Values and Biological Exposure Indices,” Edition 2000.

ACHP, 2004. Advisory Council on Historic Preservation, “Protection of Historic Properties,” 36 CFR part 800, August 5, 2004.

ANSI, 2000. American National Standards Institute, Inc., “A Guide to the Process Management Body of Knowledge,” Project Management Institute, 2000.

ANSI, 2001. American National Standards Institute Inc., “Uranium Hexafluoride—Packaging for Transport,” ANSI N14.1-2001, February 1, 2001.

APTS, 2009a. Advanced Process Technology Systems, LLC, “International Isotopes Uranium Processing & Fluorine Extraction Facility Site Selection Report,” Paducah, KY, January 2009.

Ash, 1963. S. R. Ash, “Groundwater Conditions in Northern Lea County, New Mexico,” New Mexico, U.S. Geological Survey, Hydrologic Investigations Atlas HA-62, 1963.

ASTM, 1992. American Society for Testing and Materials, “Standard Guide for Sampling Ground Water Monitoring Wells,” ASTM Standard D4448, Reapproved, 1992.

ASTM, 1993. American Society for Testing and Materials, “Classification of Soils for Engineering Purposes (Unified Soil Classification System),” ASTM Standard D2487-93, 1993.

ASTM, 2003. American Society for Testing and Materials International, *Standard Guide for Selection of Environmental Noise Measurements and Criteria*, ASTM E1686-03, ASTM International, West Conshohocken, PA., 2003.

ASTM, 2002. American Society for Testing and Materials, “Standard Guide for Selection of Environmental Noise Measurements and Criteria,” ASTM Standard E1686-02, 2002.

BBCI, 2009. BBC International, Section 27, Township 18 South, Range 36 East Hobbs, New Mexico (Proposed International Isotopes Site, Phase I Environmental Site Assessment. June 25, 2009

BBER, 2002. Bureau of Business and Economic Research, “Population Projections for New Mexico and Counties,” University of New Mexico, Albuquerque, New Mexico, August 2002.

BBER, 2007a. Bureau of Business and Economic Research, “Population, Housing and Education in Lea County,” Report to the Lea County Community Improvement Corporation, University of New Mexico, Albuquerque, New Mexico, November 13, 2007. <https://repository.unm.edu/dspace/handle/1928/7701>

BBER, 2007b. Bureau of Business and Economic Research, “The Economy of Lea County and the Larger Region,” Report to the Lea County Community Improvement Corporation, University of New Mexico, Albuquerque, New Mexico, November 13, 2007.

- BBER, 2009. Bureau of Business and Economic Research, University of New Mexico, Albuquerque, New Mexico, 2009. <http://bber.unm.edu/econ/UnempRtQtr.htm>
- BEA, 1997. Bureau of Economic Analysis Regional, "A User Handbook for the Regional Input-Output Modeling Systems (RIMS II)," U.S. Department of Commerce, Washington, D.C., 1997.
- Beck, 1980. H.L. Beck, C.V. Gogolak, K.M. Miller, and W.M. Lowder, *Perturbations on the Natural Radiation Environment Due to the Utilization of Coal as an Energy Source*, in "Natural Radiation Environment III," CONF-780422, U.S. Department of Energy, 1980.
- Benyus, 1989. J. M. Benyus, "The Field Guide to Wildlife Habitats of the Western United States," Simon & Schuster Inc., 1989.
- BFFRIT, 2009. Black-Footed Ferret Recovery Implementation Team, "Black-Footed Ferret Recovery Program," 2009. <http://www.blackfootedferret.org/who-we-are.htm>
- Biwer et al., 2001. B. M. Biwer, F. A. Monette, L. A. Nieves, and N. L. Ranek, "Transportation Impact Assessment for Shipment of Uranium Hexafluoride (UF₆) Cylinders from the East Tennessee Technology Park to the Portsmouth and Paducah Gaseous Diffusion Plants, ANL/EAD/TM-112, Argonne National Laboratory, Argonne, Ill, October 2001.
- BLM, 2009a. Bureau of Land Management, BLM Handbook H-8410-1 "Visual Resource Inventory," U.S. Department of the Interior, Washington, D.C, 2009. <http://www.blm.gov/nstc/VMR/8410.htm>
- BLM, 2009b. Bureau of Land Management, BLM Handbook H-8431-1, "Visual Resource Contrast Rating," U.S. Department of the Interior, Washington, D.C, 2009. <http://www.blm.gov/nstc/VMR/8410.htm>
- BLS, 2008. Bureau of Labor Statistics, "2007 Survey of Occupational Injuries and Illnesses, Summary Estimates Charts Package," U.S. Department of Labor, Washington, D.C, October 23, 2008.
- BLS, 2009. Bureau of Labor Statistics, U.S. Department of Labor, Washington, D.C, 2009. <http://www.bls.gov/sae/> , <http://www.bls.gov/lau>
- Campbell, 1972. H. Campbell, "A Population Study of the Lesser Prairie Chickens in New Mexico," *Journal of Wildlife Management*, 36:689-699, 1972.
- Cb-Salary, 2009, Career Builder Web Site, www.cbsalary.com-calculator
- CDCP, 2001. Centers for Disease Control and Prevention, "Report to Congress, A Feasibility Study of the Health Consequences to the American Population of Nuclear Weapons Tests Conducted by the United States and Other Nations," August 2001.
- CEQR, 2001. City Environmental Quality Review, "CEQR Technical Manual," New York City Department of Environmental Protection, 2001.
- CFR, 1996. Code of Federal Regulations, 24 CFR Part 51, Environmental Criteria and Standards, Subpart B, "Noise Abatement and Control," 1996.

CFR, 2009a. Title 10, Code of Federal Regulations, Part 20, Standards for Protection against Radiation, as amended, 2009.

CFR, 2009b. Title 10, Code of Federal Regulations, Part 30, Rules of General Applicability to Domestic Licensing of By-product Material, 2009.

CFR, 2009c. Title 10, Code of Federal Regulations, Part 40, Domestic Licensing of Source Material, 2009.

CFR, 2009d. Title 10, Code of Federal Regulations, Part 51, Environmental Protection Regulations for Domestic Licensing and Related Regulatory Functions, 2009.

CFR, 2009e. Title 10, Code of Federal Regulations, Part 61, Licensing Requirements for Land Disposal of Radioactive Waste, 2009.

CFR, 2009f. Title 10, Code of Federal Regulations, Part 70, Domestic Licensing of Special Nuclear Material, 2009.

CFR, 2009g. Title 29, Code of Federal Regulations, Part 1910, Occupational Safety and Health Standards, 2009.

CFR, 2009h. Title 40, Code of Federal Regulations, Part 50, National Primary and Secondary Ambient Air Quality Standards, 2009.

CFR, 2009i. Title 40, Code of Federal Regulations, Part 59, National Volatile Organic Compound Emission Standards for Consumer and Commercial Products, 2009.

CFR, 2009j. Title 40, Code of Federal Regulations, Part 60, Standards of Performance for New Stationary Sources, 2009.

CFR, 2009k. Title 40, Code of Federal Regulations, Part 61, National Emission Standards for Hazardous Air Pollutants, 2009.

CFR, 2009l. Title 40, Code of Federal Regulations, Part 68.130, Risk Management Program, 2009.

CFR, 2009m. Title 40, Code of Federal Regulations, Part 71, Packaging and Transportation of Radioactive Material, 2009.

CFR, 2009o. Title 40, Code of Federal Regulations, Part 112, Oil Pollution Prevention, 2009.

CFR, 2009p. Title 40, Code of Federal Regulations, Part 122, NPDES: Regulations Addressing Cooling Water Intake Structures for New Facilities, 2009.

CFR, 2009s. Title 40, Code of Federal Regulations, Part 129, Toxic Pollutant Effluent Standards, 2009.

CFR, 2009t. Title 40, Code of Federal Regulations, Parts 141-143, National Primary and Secondary Drinking Water Regulations, 2009.

CFR, 2009u. Title 40, Code of Federal Regulations, Part 190, Environmental Radiation Protection Standards for Nuclear Power Operations, 2009.

CFR, 2009v. Title 40, Code of Federal Regulations, Part 260, Hazard Waste Management System: General, 2009. http://www.access.gpo.gov/nara/cfr/waisidx_03/40cfr260_03.html

CFR, 2009w. Title 40, Code of Federal Regulations, Part 261, Identification and Listing of Hazardous Waste, 2009.

CFR, 2009x. Title 40, Code of Federal Regulations, Part 262, Standards Applicable to Generators of Hazardous Waste, 2009.
http://ecfr.gpoaccess.gov/cgi/t/text/textidx?c=ecfr&tpl=/ecfrbrowse/Title40/40cfr262_mai

CFR, 2009y. Title 40, Code of Federal Regulations, Part 263, Standards Applicable to Transporters of Hazardous Waste, 2009.
http://ecfr.gpoaccess.gov/cgi/t/text/textidx?c=ecfr&tpl=/ecfrbrowse/Title40/40cfr263_mai

CFR, 2009z. Title 40, Code of Federal Regulations, Part 264, Standards for Owners and Operators of Hazardous Waste Treatment, Storage, and Disposal Facilities, 2009.
http://ecfr.gpoaccess.gov/cgi/t/text/textidx?c=ecfr&tpl=/ecfrbrowse/Title40/40cfr264_mai

CFR, 2009aa. Title 40, Code of Federal Regulations, Part 265, Interim Status Standards for Owners and Operators of Hazardous Waste Treatment, Storage, and Disposal Facilities, 2009.
http://ecfr.gpoaccess.gov/cgi/t/text/textidx?c=ecfr&tpl=/ecfrbrowse/Title40/40cfr265_mai

CFR, 2009bb. Title 40, Code of Federal Regulations, Part 266, Standards for the Management of Specific Hazardous Wastes and Specific Types of Hazardous Waste Management Facilities, 2009.
http://ecfr.gpoaccess.gov/cgi/t/text/textidx?c=ecfr&tpl=/ecfrbrowse/Title40/40cfr266_mai

CFR, 2009cc. Title 40, Code of Federal Regulations, Part 268, Land Disposal Restrictions, 2009.
http://ecfr.gpoaccess.gov/cgi/t/text/text-idx?c=ecfr&tpl=/ecfrbrowse/Title40/40cfr268_mai

CFR, 2009dd. Title 40, Code of Federal Regulations, Part 270, EPA Administered Permit Program: The Hazardous Waste Permit Program, 2009.
http://ecfr.gpoaccess.gov/cgi/t/text/textidx?c=ecfr&tpl=/ecfrbrowse/Title40/40cfr270_mai

CFR, 2009ee. Title 40, Code of Federal Regulations, Part 302.4, Appendix A, Designation, Reportable Quantities, and Notification, 2009.

CFR, 2009ff. Title 40 Code of Federal Regulations Parts 350 to 372, The Emergency Planning and Community Right-to-Know Act of 1986, 2009.

CFR, 2009gg. Title 49, Code of Federal Regulations, Part 107 through Part 400, Hazardous Materials Sections, 2009.

CFR, 2009hh. Title 49, Code of Federal Regulations, Part 171, General Information, Regulations and Definitions, 2009.

CFR, 2009ii. Title 49, Code of Federal Regulations, Part 173, Shippers – General Requirements for Shipments and Packaging, 2009.

CFR, 2009jj. Title 49, Code of Federal Regulations, Part 177-179, Specifications for Tank Cars, 2009.

CFR, 2009kk. Title 10, Code of Federal Regulations, Part 50, Appendix B, Quality Assurance Criteria for Nuclear Power Plants and Fuel Reprocessing Plants, 2009.

CFR, 2009ll. Title 10 Code of Federal Regulations, Part 40.36, Financial Assurance and Recordkeeping for Decommissioning, 2009. http://edocket.access.gpo.gov/cfr_2003/10cfr40.36.htm

LES, 2004. Louisiana Energy Systems, National Enrichment Facility Emergency Plan, Eunice, New Mexico, July 2004

LES, 2005. Louisiana Energy Systems, National Enrichment Facility Environmental Report, Eunice, New Mexico, April 2005.

Cowan, 1994. J.P. Cowan, Handbook of Environmental Acoustics, Van Nostrand Reinhold, New York, New York, 1994.

Davis, 1974. W. B. Davis, The Mammals of Texas, Texas Parks and Wildlife Division, 1974.

Dick-Peddie, 1993. W. A. Dick-Peddie, “New Mexico Vegetation, Past Present and Future,” University of New Mexico Press, 1993.

DOA, 1993. U.S. Department of Agriculture, “Handbook of Field Methods for Monitoring Land Birds,” GTR PSW-144, Washington, D.C., 1993.

DOA, 1995. U.S. Department of Agriculture, “Monitoring Bird Populations by Point Counts,” GTR PSW-GTE-149, Washington, D.C., 1995.

DOC, 2000a. U.S. Department of Commerce, GCT-PH1-R, Population, Housing Units, Area and Density: 2000, Data Set: Census 2000 Summary File 1 (SF 1), Geographic Area: Texas – County, U.S. Census Bureau, Washington, D.C., 2000.

DOC, 2000b. . U.S. Department of Commerce, GCT-PH1-R, Population, Housing Units, Area and Density: 2000, Data Set: Census 2000 Summary File 1 (SF 1), Geographic Area: New Mexico – Place & County, U.S. Census Bureau, Washington, D.C., 2000.

DOC, 2000c. . U.S. Department of Commerce, GCT-PH1, Population, Housing Units, Area and Density: 2000, Data Set : Census 2000 Summary File 1 (SF 1), Geographic Area: Texas – Population of Texas Cities Arranged in Alphabetical Order, U.S. Census Bureau, Washington, D.C., 2000.

DOC, 2000d. . U.S. Department of Commerce, PCT12. Sex By Age [209] – Universe: Total population, Data Set: Census 2000 Summary File 1 (SF 1), Geographic Area: New Mexico/Texas – Counties, U.S. Census Bureau, Washington, D.C., 2000.

DOC, 2002. U.S. Department of Commerce, U.S. Census Bureau, Washington, D.C., 2002.

DOE, 1980. U.S. Department of Energy, "Seismicity on the Area of the Waste Isolation Pilot Plant (WIPP)," SAND-80-7096, Washington, D.C., May 1980.

DOE, 1988. U.S. Department of Energy, "Radioactive Waste Management," DOE Order 5820.2A, Washington, D.C., September 26, 1988.

DOE, 1997b. U.S. Department of Energy, "Waste Isolation Pilot Plant Disposal Phase Final Supplemental Environmental Impact Statement," Chapter 4, Description of the Affected Environments, Washington, D.C., September, 1997.

DOE, 1999. U.S. Department of Energy, "Final Programmatic Environmental Impact Statement for Alternative Strategies for the Long-Term Management and Use of Depleted Uranium Hexafluoride," Summary, DOE EIS-0269, Washington, D.C., April 1999.

DOE, 2003d. U.S. Department of Energy, "Waste Isolation Pilot Plant Contact Handled (CH) Waste Safety Analysis Report," DOE/WIPP-95-2065 Rev. 7, Washington, D.C., 2003.

DOE, 2004a. U.S. Department of Energy, "Final Environmental Impact Statement for Construction and Operation of a Depleted Uranium Hexafluoride Conversion Facility at the Paducah, Kentucky Site," DOE/EIS-0359, Washington, D.C., June 2004.

DOE, 2004b. U.S. Department of Energy, "Final Environmental Impact Statement for Construction and Operation of a Depleted Uranium Hexafluoride Conversion Facility at the Portsmouth, Ohio Site," DOE/EIS-0360, Washington, D.C., June 2004.

DOE, 2008. U.S. Department of Energy, "Draft Environmental Assessment, Disposition of DOE Excess Depleted Uranium, Natural Uranium, and Low-Enriched Uranium," DOE/EA-1607, Washington, D.C., December 23, 2008.

DOL, 2003. U.S. Department of Labor, Wages, Earnings, and Benefits Webpage, Bureau of Labor Statistics, Washington, D.C., 2003.

DOL, 2004. U.S. Department of Labor, "State Occupational Injuries, Illnesses, and Facilities," Bureau of Labor Statistics, Washington, D.C.,

DWS, 2009, New Mexico Department of Workforce Solutions, Web Site, Wages and Rates, 2009.

EDCLC, 2000. Economic Development Corporation of Lea County, "Lea County Fact Book," Hobbs, New Mexico, January, 2000.

EDCLC, 2008. Economic Development Corporation of Lea County, Site Selection Proposal Prepared for International Isotopes Inc. for the Purpose of a Uranium Processing and Fluorine Extraction Process Facility, Hobbs, New Mexico, 2008.

EDCLC, 2009a. Economic Development Corporation of Lea County, "New Mexico's Oil and Natural Gas," Hobbs, New Mexico, 2009.

EDCLC, 2009b. Economic Development Corporation of Lea County, "Hobbs, NM It All Happens Here," Hobbs, New Mexico, 2009.

EIA, 2009. Energy Information Administration, "Electricity Demand, Annual Energy Outlook," U.S. Department of Energy, Washington, D.C., 2009. <http://www.eia.doe.gov/oiaf/aeo/electricity.html>

Eicholz, 1980. G.G. Eicholz, F.J. Clarke, and B. Kahn, *Radiation Exposure from Building Materials*, "Natural Radiation Environment III," CONF-780422, U.S. Department of Energy, Washington, D.C., 1980.

Ellis, 2008. Verbal discussions with John Ellis, President, Sequoyah Fuels Corporation, Gore, Oklahoma, May, 2008.

Emerson, 2003. Emerson Process Management, "Produced Water Injection Application Discussion," June 15, 2003.

Energy Justice Network, 2009. Energy Justice Network, *Helping Communities Protect Themselves from Polluting Energy and Waste Technologies*, Philadelphia, Pennsylvania, 2009. <http://www.energyjustice.net/resources/>

EO, 1970. Executive Order 11514, Protection and Enhancement of Environmental Quality, March 5, 1970.

EO, 1977. Executive Order 11988, Floodplain Management, May 24, 1977.

EO, 1994. Executive Order 12898, Federal Actions to Address Environmental Justice in Minority Populations and Low-Income Populations, February 11, 1994.

EO, 1996. Executive Order 13007, Indian Sacred Sites, May 29, 1996.

EO, 2000. Executive Order 13175, Consultation and Coordination with Indian Tribal Governments, November 6, 2000.

EPA, 1972. U.S. Environmental Protection Agency, G.C. Holzworth, "Mixing Heights, Wind Speeds, and Potential for Urban Air Pollution Throughout the Contiguous United States," Office of Air Programs, Washington, D.C., 1972.

EPA, 1973. U.S. Environmental Protection Agency, "Public Health and Welfare Criteria for Noise," EPA 550/9-73-002, Washington, D.C., 1973.

EPA, 1974. U.S. Environmental Protection Agency, "Information on Levels of Environmental Noise Requisite to Protect Public Health and Welfare with an Adequate Margin of Safety," EPA/ONAC 550/9-74-004, Washington, D.C., March 1974.

EPA, 1987. U.S. Environmental Protection Agency, "Industrial Source Complex (ISC) Dispersion Model User's Guide," 2nd Ed (Revised), Office of Air Quality Planning and Standards, Washington, D.C., 1987.

EPA, 1988. U.S. Environmental Protection Agency, "Limiting Values of Radionuclide Intake and Air Concentration and Dose Conversion Factors for Inhalation, Submersion, and Ingestion," Federal Guidance Report No. 11, EPA- 520/1-88-020, Washington, D.C., September 1988.

EPA, 1993a. U.S. Environmental Protection Agency, Federal Guidance Report No. 12, External Exposure to Radionuclides in Air, Water, and Soil, Washington, D.C., 1993.

EPA, 1993b. U.S. Environmental Protection Agency, Water Quality Criteria, Parameter Values by Agency/Station, Station ID# 00311105, Washington, D.C., 1993.

EPA, 1993c. Environmental Protection Agency, *Habitat Evaluation: Guidance for the Review of Environmental Impact Assessment Documents*, U.S. Department of the Interior, U.S. Environmental Protection Agency, Office of Federal Activities, Washington, D.C., 1993.

EPA, 1995. U.S. Environmental Protection Agency, "Endangered and Threatened Wildlife and Plants: 12-Month Finding for a Petition to List the Swift Fox as Endangered, Federal Register," Volume 60, Number 116, Washington, D.C., June 16, 1995.

EPA, 1998. U.S. Environmental Protection Agency, "Final Guidance for Incorporating Environmental Justice Concerns in EPA's NEPA Compliance Analyses," Washington, D.C., 1998.

EPA, 2004a. U.S. Environmental Protection Agency, Green Book-Nonattainment Areas for Criteria Pollutants, Washington, D.C., January 20, 2004.

EPA, 2009a. U.S. Environmental Protection Agency, "Compilation of Air Pollutant Emissions Factors," Washington, D.C., 2009. <http://www.epa.gov/oms/ap42.htm>

EPA, 2009b. U.S. Environmental Protection Agency, AirData Web Site, Washington, D.C., 2009. <http://www.epa.gov/oar/data/emisdist.html?st~TX~Texas>

EPA, 2009d. EnviroMapper Internet Site, U.S. Environmental Protection Agency, Washington, D.C., 2009.

EPA, 2009e. U.S. Environmental Protection Agency, National Emissions Standards for Hazardous Air Pollutants: Halogenated Solvent Cleaning, 40 CFR Parts 9 and 63. Washington, D.C. 2009.

FAN, 1979. Fluoride Action Network, H.F.J. Denziner, et. al, Fluorine Recovery in the Fertilizer Industry, A Review, Phosphorous & Potassium, No. 103, pp. 33-39, 1979.

FedStats, 2004. Mapstats {New Mexico and Texas Population Statistics}, February 2, 2004. <<http://www/>

FEMA, 2001. Federal Emergency Management Agency, "NEHRP Recommended Provisions for Seismic Regulations for New Buildings and Other Structures, Part 1 – Provisions," FEMA 368, 2000 Edition, Washington, D.C., March 2001.

FHWA, 1995. Federal Highway Administration, "Highway Traffic Noise Analysis and Abatement Policy and Guidance," U.S. Department of Transportation, Noise and Branch Quality Branch, Washington, D.C., June 1995.

FHWA, 2007. Federal Highway Administration, *Synthesis of Noise Effects on Wildlife Populations*, U.S. Department of Transportation. 2007

Fitzgerald, 1997. L.A. Fitzgerald, C.W. Painter, D.S. Sias, and H.L. Snell, The Range, Distribution, and Habitat of *Sceloporus arenicolus* in New Mexico, Final report submitted to the New Mexico Department of Game and Fish, Contract #80-516.6-01, 1997.

FR, 1999. Federal Register, "Record of Decision for Long-Term Management and Use of Depleted Uranium Hexafluoride," 64FR43358, August 10, 1999.

FR, 2003. Federal Register, "Notice of Policy Statement on the Treatment of Environmental Justice Matters in NRC Regulatory and Licensing Actions," 68 FR 62,642, November 5, 2003.

FRBD, 2005. Federal Reserve Bank of Dallas, D'Ann Peterson and Laila Assanie, The Face of Texas Jobs, People, Business, Change, Dallas Texas, 2005.

http://www.dallasfed.org/research/pubs/fotexas/fotexas_petersen.html

Freeze, 1979. R.A. Freeze and J.A. Cherry, Groundwater, Prentice-Hall, Inc., Englewood Cliffs, NJ, p. 604, 1979.

FWS, 2001. U.S. Fish and Wildlife Services, Arctic Peregrine Falcon, 2001.

FWS, 2003. U.S. Fish and Wildlife Services, Status Assessment and Conservation Plan for the Western Burrowing Owl in the United States, Biological Technical Publication BTP-R6001-2003, 2003.

<http://www.fws.gov/southwest/es/oklahoma/peregrn2.htm>

Grazulis, 1993. P. Grazulis, Significant Tornadoes, 1680-1991, Environmental Films, Thomas July 1993.

Hale et. al, 1965. W. E. Hale, L. J. Reiland, and J. P. Beverage, Characteristics of the Water Supply in New Mexico, New Mexico State Engineer Technical Report 31, New Mexico Office of the State Engineer, 1965.

Hartmann et. al., 2001, D. Hartmann, B. Le Motais, and B. Buperret, The French Approach for Management of Depleted Uranium, A Constantly Improved Technology, 2001.

HHS, 2001. U.S. Department of Health and Human Services, "Toxicological Profile for Fluorides, Hydrogen Fluoride, and Fluorine," Draft for Public Comment, Agency for Toxic Substances and Disease Registry (ATSDR), Public Health Services, Washington, D.C., 2001.

Hobbs, 2000. T.G. Hobbs, *Radioactivity Measurements on Glazed Ceramic Surfaces*, Journal of Research of the National Institute of Standards and Technology 105, 275-283, 2000.

Hofman, 2009. Verbal Discussion with B. Hofman, Meeting of International Isotopes Fluorine Products, Applied Process Technology Systems and Honeywell, Incorporated Representatives, Nashville, Tennessee, April 9, 2009.

Holzworth, 1972. G. C. Holzworth, Mixing Heights, Winds Speeds, and Potential for Urban Air Pollution Throughout the Contiguous United States, Office of Air Programs, U.S. Environmental Protection Agency, Washington, D.C., January 1972.

HPWD, 2009. High Plains Underground Water District, The Ogallala Aquifer, 2009.

HUD, 1985. U.S. Department of Housing and Urban Development, "The Noise Guidebook," HUD-953-CPD, Washington, D.C., 1985.

ICRP, 1995. International Commission on Radiological Protection, "Age-Dependent Doses to Members of the Public from Intake of Radionuclides: Part 5 Compilation of Ingestion and Inhalation Dose Coefficients," ICRP Publication 72, September 1995.

IIFP, 2009. International Isotopes Fluorine Products, Inc., "Integrated Safety Analysis", December, 2009.

IPANM, 2009. Independent Petroleum Association of New Mexico, Energy Production Publication, 2009.

Johnsgard, 1975. P. A. Johnsgard, North American Game Birds, University of Nebraska Press, 1975.

LCNM, 2009, Lea County, New Mexico, "Welcome to Lea County", 2009. <http://www.leacounty.net>

LCWUA, 1998-1999. Lea County Water Users Association, "Lea County Regional Water Plan, Water Resources Assessment," Approved by Interstate Stream Commission in 1999. Hobbs, New Mexico, 1998-1999. http://www.ose.state.nm.us/isc_regional_plans16.html.

LCWUA, 2000. Lea County Water Users Association, "Lea County Regional Water Plan, Water Resources Assessment," Hobbs, New Mexico, December 7, 2000. http://www.ose.state.nm.us/isc_regional_plans16.html

LES, 2005. Louisiana Energy Services Claiborne Enrichment Center, "Louisiana Energy Systems, National Enrichment Facility Environmental Report," Eunice, New Mexico, April 2005.

LLNL, 1997a. Lawrence Livermore National Laboratory, Elayat, Hatem, J. Zoller, L. Szytel, "Cost Analysis Report For the Long-Term Management of Depleted Uranium Hexafluoride," UCRL-AR-127650, Livermore, California, May 1997.

LLNL, 1997b. Lawrence Livermore National Laboratory, J.W. Dubrin, et. al., "Depleted Uranium Hexafluoride Management Program," UCRL-AR-124080 Vol. 1, Rev. 2 and Vol. 2, Livermore, California, May 1997.

Machette, 1998. M.N. Machette, S.F. Personius, K.I. Kelson, K.M. Haller and R.L. Dart, Map of Quaternary Faults and Folds in New Mexico and Adjacent Areas, 1998.

Machette, 2000. M.N. Machette, S.F. Personius, K.I. Kelson, K.M. Haller and R.L. Dart, Map and Data for Quaternary Faults and Folds in New Mexico, 2000. <http://earthquake.usgs.gov/regional/qfaults/contributors.php>

Manomet, 2009. Manomet, Center for Conservation Sciences, 2009.

Marshall, 1973. J. L. Marshall, Lightning Protection, John Wiley & Sons, New York, NY, 1973.

McAda, 1984. , D. P. McAda, Predicted Water-Level Declines in the Ogallala Aquifer in Lea County, New Mexico, U.S. Geological Survey, Water Resources Investigations Report 84-4062. 1984.

McGuire, 2007. V. L. McGuire, Changes in Water Levels and Storage in the High Plains Aquifer, Predevelopment to 2005, U.S. Geological Services, Fact Sheet 2007-3029, May 2007.

Morel, 2008. B. Morel and B. Duperret, "Uranium and Fluorine Cycles in the Nuclear Industry," Journal of Fluorine Chemistry, May 2008.

Musharrafieh and Chudnoff, 1999. Numerical Simulation of Groundwater Flow for Water Rights Administration in Lea County Underground Water Basin New Mexico, New Mexico Interstate Stream Commission, New Mexico Office of the State Engineer, Report 99-1, 1999.

Michalik, 2001. , L. Michalik, Cultural Resources Inventory of the Proposed Minerals Materials Put Near Eunice, Lea County, New Mexico. Archaeological Services, Report No 1748, Las Cruces, New Mexico, 2001.

NAS, 1980. National Academy of Science, The Effects on Populations of Exposure to Low Levels of Ionizing Radiation (BIER III), National Research Council on the Biological Effects of Ionizing Radiation, 1980.

NAS, 1988. National Academy of Science, Health Effects of Radon and Other Internally-Deposited Alpha-Emitters (BIER IV), National Research Council on the Biological Effects of Ionizing Radiation, 1988.

NAS, 2007. National Audubon Society, Bell's Vireo Watch List 2007 Status, 2007.
<http://web1.audubon.org/science/species/watchlist/profile.php?speciesCode=belvir>

National Research Council, 1977. *Guidelines for Preparing Environmental Impact Statements on Noise*. Committee on Hearing, Bioacoustics and Biomechanics, Assembly of Behavioral and Social Sciences. National Academy of Sciences, National Research Council, Committee on Hearing, Bioacoustics, and Biomechanics, Washington, DC.

NCDC, 1998. National Climatic Data Center, International Surface Weather Observations 1982-1997, September 1998.

NCDC, 2004. National Climatic Data Center, Storm Events

NCRP, 1976. National Council on Radiation Protection and Measurements, "Environmental Radiation Measurements," NCRP Report No. 50, Bethesda, Maryland, 1976.

NCRP, 1980. National Council on Radiation Protection and Measurements, "Influence of Dose and its Distribution in Time on Dose-Response Relationships for Low-LET Radiations," NCRP Report No. 64, Bethesda, Maryland: April 1, 1980.

NCRP, 1987a. National Council of Radiation Protection and Measurements, "Exposure of the Population in the United States and Canada from Natural Background Radiation," NCRP Report No. 94, Bethesda, Maryland: 1987.

NCRP, 1987b. National Council of Radiation Protection and Measurements, "Radiation Exposure of the U.S. Population from Consumer Products and Miscellaneous Sources," NCRP Report No. 95, Bethesda, Maryland: 1987.

NCRP, 1989. National Council of Radiation Protection and Measurements, "Radiation Protection for Medical and Allied Health Personnel," NCRP Report No. 105, Bethesda, Maryland: 1989.

Newman, 1977. J.R. Newman and J.J. Murphy, Effects of Industrial Fluoride on Black-Tailed Deer (Preliminary Report), Journal of the International Society for Fluoride Research, 12 (3): pp. 129-135, 1979.

New York City Department of Environmental Protection, 2005, *Chapter 28 Citywide Construction Noise Mitigation*, Local Law 113, Administrative Code of the City of New York, NY, December, 2005.

Nicholson and Clebsch, 1961. A. Nicholson, Jr. and A. Clebsch, Jr., Geology and Groundwater Conditions in Southern Lea County, New Mexico, Groundwater Report 6, U.S. Geological Survey, New Mexico Institute of Mining and Technology, 1961.

NIOSH, 2005. National Institute for Occupational Safety and Health, "Pocket Guide to Chemical Hazards, Hydrogen Fluoride, Center for Disease Control and Prevention, Department of Health and Human Services, Atlanta, Georgia, 2005.

NMAC, 2000. New Mexico Administrative Code 20.4.1, Hazardous Waste Management, New Mexico, June 2000.

NMAC, 2001a. New Mexico Administrative Code 20.3.2, Radiation Protection, Registration of Radiation Machines and Services, New Mexico, November 2001.
<http://www.nmcpr.state.nm.us/nmac/parts/title20/20.003.0002.htm>

NMAC, 2001b. New Mexico Administrative Code 4.10.12, Cultural Properties and Historic Preservation, Implementation of the Prehistoric and Historic Sites Preservation Act, New Mexico, October 2001.
<http://www.nmcpr.state.nm.us/nmac/parts/title04/04.010.0012.htm>

NMAC, 2002a. New Mexico Administrative Code 20.2.78, Air Quality Emission Standards for Hazardous Air Pollutants, New Mexico, February 2002.
<http://www.nmcpr.state.nm.us/nmac/parts/title20/20.002.0078.htm>

NMAC, 2002b. New Mexico Administrative Code, "Standards for Groundwater of 10,000 mg/L TDS Concentrations or Less," 20.6.2.3103 NMAC, New Mexico Water Quality Control Commission, New Mexico, September 2002. <http://www.nmcpr.state.nm.us/nmac/parts/title20/20.006.0002.htm>

NMACP, 2009. New Mexico Avian Conservation Partners, Baird's Sparrow, 2009.

NMBGMR, 2009, New Mexico Bureau of Mines and Mineral Resources, "Frequently Asked Questions About Water," Socorro, New Mexico, 2009.

<http://geoinfo.nmt.edu/faq/water/>

NMCRIS, 2009. New Mexico Cultural Resources Investigation/Survey 113862, "Cultural Resource Survey of 640 Acres for the Arkansas Junction Site, Lea County, New Mexico," Gordon Environmental, Bernalillo, New Mexico, May 2009. <http://stubbs.arms.state.nm.us/servlet.com.esri.Esrimap?Serv...>

NMDOT, 2009, Email from Martinez, Juan. A, New Mexico Department of Transportation, Santa Fe, New Mexico, 2009.

NMED, 2002. New Mexico Environment Department, Ambient Air Quality Standards. Santa Fe, New Mexico, October 31, 2002.

NMEDAQB, 2009. New Mexico Environment Department Air Quality Bureau, Santa Fe, New Mexico, 2009.

NMEM&NRD, 2008. Mexico Energy, Minerals and Natural Resources Department, "2008 Annual Report," New Santa Fe, New Mexico. 2008.

NMGF, 2004. N.M. Department of Game and Fish, Charles W. Painter, "Conservation of the Sand Dune Lizard in New Mexico, Recommendations Based on the Management Plan for the Sand Dune Lizard," New Mexico, February 2004.

NMGF, 2009. New Mexico Department of Game and Fish, "Biota Information System of New Mexico," New Mexico, 2009.

NMIMT, 1977. New Mexico Institute of Mining and Technology, "Surficial Geology of Southeast New Mexico, Geologic Map 41," New Mexico Bureau of Mines and Mineral Resources: 1:500,000, New Mexico, 1977.

NMIMT, 2002. New Mexico Institute of Mining and Technology, A.R. Sanford, K. Lin, I. Tsai and L.H. Jaksha, "Earthquake Catalogs for New Mexico and Bordering Areas: 1869-1998," New Mexico Bureau of Geology and Mineral Resources, Circular 210, New Mexico, 2002.

NMIMT, 2003. New Mexico Institute of Mining and Technology, "Geologic Map of New Mexico," New Mexico Bureau of Geology and Mineral Resources, 1:500,000, New Mexico, 2003.

NMSHTD, 2003. New Mexico State Highway & Transportation Department, Consolidated Highway Database, Road Segments by Traffic Annual Average Daily Traffic Info, New Mexico, May 2003.

NMSU, 1996. New Mexico State University, "Lesser Prairie-Chickens Movements and Home Ranges in New Mexico," New Mexico, Riley, et al., Department of Fisheries and Wildlife Sciences, New Mexico, 1996.

NMWQCC, 2002. New Mexico Water Quality Control Commission, State of New Mexico, Standards for Interstate and Intrastate Surface Waters, 20.6.4.NMAC, New Mexico, October 2002.
http://www.nmenv.state.nm.us/NMED_regs/swqb/20MNAC6_1.html

NRC, 1972. U.S. Nuclear Regulatory Commission, "Environmental Survey of Transportation of Radioactive Materials to and from Nuclear Power Plants," WASH-1238, Washington, D.C., December 1972. <http://www.nrc.gov/reading-rm/doc-collections/cfr/part051/part051-0052.html>

NRC, 1974. U.S. Nuclear Regulatory Commission, Regulatory Guide 8.11, Applications of Bioassay for Uranium, Washington, D.C., June 1974.

NRC, 1975a. U.S. Nuclear Regulatory Commission, "Reactor Safety Study: An Assessment of Accident Risks in U.S. Commercial Nuclear Power Plants – Appendix VI," NUREG-75/014 (WASH-1400), Washington, D.C., October 1975.

NRC, 1977a. U.S. Nuclear Regulatory Commission, "Final Environmental Statement on the Transportation of Radioactive Material by Air and Other Modes," NUREG/CR-0170, Washington, D.C., 1977.

NRC, 1977c. U.S. Nuclear Regulatory Commission, "Calculation of Annual Doses to Man from Routine Releases of Reactor Effluents for the Purposes of Evaluating Compliance with 10 CFR Part 50, Appendix 1," Regulatory Guide 1.109, Revision 1, Washington, D.C., October 1977. <http://www.nrc.gov/reading-rm/doc-collections/cfr/part050/>

NRC, 1978. U.S. Nuclear Regulatory Commission, "Technology, Safety and Costs of Decommissioning a Reference Pressurized Water Reactor Power Station," NUREG/CR-0130, Washington, D.C., June 1978.

NRC, 1982. U.S. Nuclear Regulatory Commission, Washington, "XOQDOQ: Computer Program for the Meteorological Evaluation of Routine Effluent Releases at Nuclear Power Stations," NUREG/CR- 2919, Washington, D.C., 1982.

NRC, 1983. U.S. Nuclear Regulatory Commission, "Atmospheric Dispersion Models for Potential Accident Consequence Assessments at Nuclear Power Plants," Regulatory Guide 1.145, Revision 1, Washington, D.C., 1983.

NRC, 1985. U.S. Nuclear Regulatory Commission, "Monitoring and Reporting Radioactivity in Releases of Radioactive Materials in Liquid and Gaseous Effluents from Nuclear Fuel Processing and Fabrication Plants and Uranium Hexafluoride Production Plants," Regulatory Guide 4.16, Revision 1, Washington, D.C., 1985.

NRC, 1987a. U.S. Nuclear Regulatory Commission, "Shipping Container Response to Severe Highway and Railway Accident Conditions," NUREG/CR-4829, Washington, D.C., 1987.

NRC, 1987b. U.S. Nuclear Regulatory Commission, Interpretation of Bioassay Measurements, NUREG/CR-4884, Washington, D.C., June 1987.

NRC, 1991. U.S. Nuclear Regulatory Commission, "Off-site Dose Calculation Manual Guidance: Standard Radiological Effluent Controls for Boiling Water Reactors," NUREG-1302, Washington, D.C., 1991.

NRC, 1992a. U.S. Nuclear Regulatory Commission, Regulatory Guide 8.7, Revision 1, Instructions for Recording and Reporting Occupational Radiation Exposure Data, Washington, D.C., June 1992.

NRC, 1992b. U.S. Nuclear Regulatory Commission, Regulatory Guide 8.25, Revision 1, Air Sampling in the Workplace, U.S. Nuclear Regulatory Commission, Washington, D.C., June 1992.

NRC, 1992c. U.S. Nuclear Regulatory Commission, Regulatory Guide 8.34, Monitoring Criteria and Methods To Calculate Occupational Radiation Doses, Washington, D.C., July 1992.

NRC, 1993a. U.S. Nuclear Regulatory Commission, Regulatory Guide 8.9, Revision 1, Acceptable Concepts, Models, Equations, and Assumptions for a Bioassay Program, July 1993.

NRC, 1993b. U.S. Nuclear Regulatory Commission, Regulatory Guide 8.37, ALARA Levels for Effluents from Materials Facilities, Washington, D.C., July 1993.

NRC, 1994. U.S. Nuclear Regulatory Commission, "Final Environmental Impact Statement for the Construction and Operation of Claiborne Enrichment Center, Homer, Louisiana," NUREG-1484, Volume 1, Washington, D.C., August 1994.

NRC, 1996. , U.S. Nuclear Regulatory Commission, Regulatory Guide 8.29, Revision 1, Instruction Concerning Risks from Occupational Radiation Exposure, Washington, D.C., February 1996.

NRC, 1997. U.S. Nuclear Regulatory Commission, Regulatory Guide 8.10, Revision 1, Operating Philosophy for Maintaining Occupational Radiation Exposures As Low As Is Reasonably Achievable, Washington, D.C., May 1977.

NRC, 1998a. U.S. Nuclear Regulatory Commission, Nuclear Fuel Cycle Facility Accident Analysis Handbook, (NUREG/CR-6410), Office of Nuclear Regulatory Research, Washington, D.C., March 1998. <http://www.nrc.gov/reading-rm/doc-collections/nuregs/contract/cr6410>

NRC, 1998b. U.S. Nuclear Regulatory Commission, Generic Environmental Impact Statement for License Renewal of Nuclear Plants, NUREG/CR-1437, Addendum 1, Washington, D.C., December 1998.

NRC, 1999a. U.S. Nuclear Regulatory Commission, Regulatory Guide 8.13, Revision 3, Instruction Concerning Prenatal Radiation Exposure, Washington, D.C., June 1999.

NRC, 1999b. U.S. Nuclear Regulatory Commission, Regulatory Guide 8.15, Revision 1, Acceptable Programs for Respiratory Protection, Washington, D.C., October 1999.

NRC, 2001. U.S. Nuclear Regulatory Commission, Manual of Respiratory Protection against Airborne Radioactive Materials, NUREG-0041, Washington, D.C., January 2001.

NRC, 2002a. U.S. Nuclear Regulatory Commission, Regulatory Guide 8.30, Revision 1, Health Physics Surveys in Uranium Recovery Facilities, Washington, D.C., May 2002.

NRC, 2002b. U.S. Nuclear Regulatory Commission, Regulatory Guide 8.31, Revision 1, Information Relevant to Ensuring that Occupational Radiation Exposures at Uranium Recovery Facilities Will Be As Low As Is Reasonably Achievable, Washington, D.C., May 2002.

NRC, 2002c. U.S. Nuclear Regulatory Commission, Standard Review Plan for the Review of a License Application for a Fuel Cycle Facility, Office of Nuclear Material Safety and Safeguards, NUREG-1520, Washington, D.C., March 2002.

NRC, 2003a. U.S. Nuclear Regulatory Commission, "Environmental Review Guidance for Licensing Actions Associated with NMSS Programs, Final Report," Division of Waste Management, Office of Nuclear Material Safety and Safeguards, NUREG-1748, Washington, D.C., August 2003.

NRC, 2003b. U.S. Nuclear Regulatory Commission, “Potentially Defective 1-Inch Valves for Uranium Hexafluoride Cylinders,” NRC Bulletin 2003-03, Washington, D.C., August 2003.

NRC, 2005. U.S. Nuclear Regulatory Commission, “Environmental Impact Statement for the Proposed National Enrichment Facility in Lea County, New Mexico,” NUREG-1790, Vol. 1, Washington, D.C., June 2005. <http://www.nrc.gov/reading-rm/doc-collections/nuregs/staff/sr1790/v1/>

NRC, 2007. U.S. Nuclear Regulatory Commission, Regulatory Guide 4.15, Revision 2, Quality Assurance for Radiological Monitoring Programs (Inception through Normal Operations to License Termination) – Effluent Streams and the Environment and Regulatory, Washington, D.C., July 2007. <http://plant-materials.nrcs.usda.gov/intranet/pfs.html>

NRC, 2009. U.S. Nuclear Regulatory Commission, “Multi-Agency Radiation Survey and Assessment of Materials and Equipment Manual (MARSAME),” NUREG-1575, Supplement 1, Washington, D.C., January 2009.

NRCS, 1999. Natural Resources Conservation Service, Lesser Prairie-Chicken, Fish and Wildlife Habitat Management Leaflet Number 6, U.S. Department of Agriculture, National Plant Data Center, Baton Rouge, Louisiana, 1999.

NRCS, 2003. Natural Resources Conservation Service, Black-tailed Prairie Dog, Fish and Wildlife Habitat Management Leaflet Number 23, U.S. Department of Agriculture, National Plant Data Center, Baton Rouge, Louisiana, 2005.

NRCS, 2005. Natural Resources Conservation Service, Swift Fox, Fish and Wildlife Habitat Management Leaflet Number 33, U.S. Department of Agriculture, National Plant Data Center, Baton Rouge, Louisiana, 2005.

NRCS, 2007. Hairy Grama Plant Fact Sheet, Natural Resources Conservation Service National Plant Data Center, Baton Rouge, Louisiana, 2007.

ORNL, 2000a. Oak Ridge National Laboratory, “MCNP4C Monte Carlo N-Particle Transport Code System,” CCC-700 MCNP4C2, RSICC Computer Code Collection, Oak Ridge, TN, 2000. <http://www.nea.fr/abs/html/ccc-0740.html>

OSE, 2004. New Mexico Office of the State Engineer, “New Mexico State Water Plan Appendix A, Water Resources Issues,” Santa Fe, New Mexico, 2004.

OSU, 2002. Oklahoma State University, Ecology and management of the Lesser Prairie-Chicken, Oklahoma Cooperative Extension Service, Division of Agricultural Sciences and Natural Resources, Stillwater, Oklahoma, 2002.

Peterson, 1961. R.T. Peterson, A Field Guide to Western Birds, Houghton Mifflin Company, Boston, MA, 1961.

Portland, 2004. Portland International Jetport Part 150 Update, Harris, Miller, Miller, and Hanson (HMMH), Inc., HMMH Report No. 298410, March 2004. http://www.faa.gov/airports/environmental/airport_noise/part_150/activity/

- Rainwater, 1996. K. Rainwater, Evaluation of Potential Groundwater Impacts by the WCS Facility in Andrews County, Texas, Report Submitted to the Andrews Industrial Foundation, December 1996.
- Ransom, 1981. J.E. Ransom, Harper & Row's Complete Field Guide to North American Wildlife, Harper & Row, Publishers, 1981.
- RSC, 2009. Real Estate Center, Monthly Review of the Texas Economy, Ali Anari and Mark G. Dotzour, Texas A&M University, College Station, Texas, 2009.<http://recenter.tamu.edu/pdf/1862.pdf>
- Scholle, 2000. Peter Scholle, An Introduction and Virtual Geologic Field Trip to the Permian Reef Complex, Guadalupe and Delaware Mountains, New Mexico-West Texas, New Mexico Bureau of Geology and Mineral Resources, Division of New Mexico Tech., 2000.
<http://geoinfo.nmt.edu/staff/scholle/guadalupe.html> Accessed 4/06/2009.
- Sena, 1984. A. Sena, "The Distribution and Reproductive Ecology of *Sceloporus racisosus arenicolous* in Southeastern New Mexico," Ph.D. Thesis, University of New Mexico, 1984.
- Sibley Nature Center, 2009. Sibley Nature Center, "Introduction to the Llano Estacado, Midland, Texas," 2009.
- Sinnott, 2007. R.K. Sinnott, Chemical Engineering Design, Fourth Edition, Coulson & Richardson's Series, Volume 6, Elsevier Publishing, 2007, page 267.
- Starmet, 2000. Starmet Corporation, "UF₆ De-conversion Technology, Phase II Report", Schlier et al, June 20 2000.
- Stinnett, 2002. K. Stinnett, "Lesser Prairie-Chicken (*Tympanuchus pallidicinctus*) Area of Critical Environmental Concern (ACEC), A Petition to the New Mexico BLM," 2002.
- Talley, 1997. D.J. Talley, "Characterization of a San Andres Carbonate Reservoir Using Four Dimensional, Multi-component Attribute Analysis," Master of Science Thesis, Colorado School of Mines, 1997. http://geophysics.m.nes.edu/rcp/theses/old/Tally_1997/djtindx.html
- Tax Foundation, 2006a. Tax Foundation, "State and Local Property Tax Collections Per Capita and Per Household, Fiscal Year 2006," National Press Building, Washington, D.C. 2006.
<http://www.taxfoundation.org/>
- Tax Foundation, 2006b. Tax Foundation, "State and Local General Sales Tax Collections Per Capita and Per Household, Fiscal Year 2006," National Press Building, Washington, D.C. 2006.
- Tax Foundation, 2006c. Tax Foundation, "State and Local Individual Income Tax Collections Per Capita and Per Household, Fiscal Year 2006," National Press Building, Washington, D.C. 2006.
- Texas Parks, 2009a. Texas Parks and Wildlife Department, Texas Black-tailed Prairie Dog Watch, 2009.
<http://images.google.com/imgres?imgurl> , http://www.tpwd.state.tx.us/learning/texas_natu
- Texas Parks, 2009b. Texas Parks and Wildlife Department, Yellow-billed Cuckoo, Austin, Texas, 2009.

Thalheimer, 2000. E. Thalheimer, Construction Noise Control Program and Mitigation Strategy at the Central Artery/Tunnel Project, Noise Control Engineering Journal, 48 (5), 2000.

Timmerhaus, 2003a. Timmerhaus, Peters, and West, Plant Design and Economics for Chemical Engineers, Fifth Edition, McGraw-Hill Publishing, 2003, pages 270-71.

Timmerhaus, 2003b. Op. Cit., page.268.

Timmerhaus, 2003c. Op. Cit., page 269.

Thomas, 2008. J.H. Thomas Consultants, "An Assessment of the Sequoyah Fuels DUF₄ Facility for Future New Plant Utilization of Equipment/Components (Condensed Report)", October 27, 2008.

Thomas, 2008b. Op. Cit, J.H. Thomas and G.R. Holland, pages 20-21.

Thomas, 2009. J. H. Thomas and Gary Holland, "Uranium Processing and Fluorine Extraction Facility Site Selection Report," Advanced Process Technology Systems, Paducah, KY, January 2009.

Thomas, 2008c. Op. Cit., J.H. Thomas and G.R. Holland, pages 14-15.

TMM, 2002. Times Mirror Magazines, Inc., The Deer of North America, L.L. Rue, III, 1978.

UNM, 2006. University of New Mexico, "Development of Southeastern New Mexico Regional Research Design and Cultural Resource Management Strategy," UNM Report No. 185-849, Patrick F. Hogan, Albuquerque, NM, November 22, 2006.

UNSCEAR, 1986. United Nations Scientific Committee on the Effects of Atomic Radiation, "Genetic and Somatic Effects of Ionizing Radiation," 1986.

UNSCEAR, 1988. United Nations Scientific Committee on the Effects of Atomic Radiation, "Sources, Effects and Risks of Ionizing Radiation," 1988.

UNSCEAR 2000. United Nations Scientific Committee on the Effects of Atomic Radiation, "Sources and Effects of Ionizing Radiation," 2000.

USACE, 1987. U.S. Army Corps of Engineers, Corps of Engineers Wetlands Delineation Manual, 1987.

USC, 2009a. U.S. Code, The National Environmental Policy Act of 1969 As Amended Through 1982, 42 USC 4321-4347, Public Law 91-190, 2009.

USC, 2009b. U.S. Code, The Public Health and Welfare, Noise Control, 42 USC 4901, Public Law 92-574, 2009.

USC, 2009c. U.S. Code, National Historic Preservation Act of 1966 as Amended Through 1992, 16 USC 470 et seq., Public Law, 102-575, 2009.

USC, 2009d. U.S. Code, Hazardous Material Transportation Act As Amended by the Hazardous Material Transportation Uniform Safety Act of 1990, 49 USC 1801, Public Law 101-615, 2009.

USCB, 1990. U.S. Census Bureau, 1990 Census Data, U.S. Department of Commerce, Washington, D.C., 1990.

USCB, 1997. U.S. Census Bureau, LandView III: Environmental Mapping Software, CD-TGR95-LV3-2 (NC, SC, TN, VA, WV), U.S. Department of Commerce, Washington, Washington, D.C., 1997.

USCB, 2000. U.S. Census Bureau, Table DP-3. Dataset SF-1, Profile of Selected Economic Characteristics, Table DP-4m Profile of Selected Housing Characteristics: 2000, U.S. Census Bureau, U.S. Department of Commerce, Washington, Washington, D.C., 2000.

USDA, 1974. U.S. Department of Agriculture, "Soil Survey of Lea County New Mexico," Soil Conservation Service in Cooperation with New Mexico Agricultural Experiment Station, January 1974. <http://websoilsurvey.nrcs.usda.gov/app/WebSoilSurvey.aspx>. Check date Accessed April 29, 2009

USDA, 1993. U.S. Department of Agriculture, "Handbook of Field Methods for Monitoring Land Birds," C.J. Ralph, G.R. Geupel, P. Pyle, T.E. Martin, and D.F. DeSante, Gen. Tech. Rep. PSW-GTR-144, Albany, CA: Pacific Southwest Research Station, Forest Service, Washington, D.C., 1993.

USDA, 1995. U.S. Department of Agriculture, "Monitoring Bird Populations by Point Counts," C.J. Ralph, J.R. Sauer, and S. Droege, Technical Editors, Gen. Tech. Rep. PSW-GTR-149, Albany, CA: Pacific Southwest Research Station, Forest Service, Washington, D.C., 1995.

USDA, 1999. U.S. Department of Agriculture, "Lesser Prairie-Chicken, Fish and Wildlife Habitat Management Leaflet Number 6," Natural Resources Conservation Service, Washington, D.C., September, 1999. <<http://www/>

USDA, 2002a. U.S. Department of Agriculture, Lea County: New Mexico Agricultural Statistics Service, New Mexico, and National Agricultural Statistical Service, and USDA, Washington, D.C., 2001.

USDA, 2002b. U.S. Department of Agriculture, Texas Agricultural Statistics Service, Washington, D.C., 2002.

USDA, 2004. U.S. Department of Agriculture, "Assessment of Grassland Ecosystem Conditions in the Southwestern United States," RMRS-GTR-135, Volume 1, Forest Service, Rocky Mountain Research Station, Fort Collins, CO, 2004.

USDA, 2007. U.S. Department of Agriculture, Lea County: New Mexico Agricultural Statistics Service, New Mexico, and National Agricultural Statistical Service, and USDA, Washington, D.C., 2007.

USEC, 2006. U.S. Enrichment Corporation, "Paducah DUF₆ Conversion Final Environmental Impact Statement," Paducah, KY, 2006.

USFWS, 1998. U.S. Fish and Wildlife Service, Bird Kills At Towers and Other Human-Made Structures: An Annotated Partial Bibliography (1960-1998)," Office of Migratory Bird Management, U.S. Department of the Interior, Washington, D.C., 1998.
http://library.fws.gov/Bird_Publications/birdkills_towers98.htm

USFWS, 2004. U.S. Fish and Wildlife Service, “Federal Endangered, Threatened, Proposed, and Candidate Species and Species of Concern in New Mexico,” U.S. Department of the Interior, Washington, D.C., March 25, 2004.

USFWS, 2005. U.S. Fish and Wildlife Service, “Endangered and Threatened Wildlife and Plants; Establishment of a Nonessential Experimental Population of Northern Aplomado Falcons in New Mexico and Arizona and Availability of Draft Environmental Assessment,” Federal Register, Volume 70, Number 26, U.S. Department of the Interior, Washington, D.C., February 9, 2005.
<http://ecos.fws.gov/speciesprofile/speciesReport.do?session:d=159D60D558E24BA4ED6>

USFWS, 2006. U.S. Fish and Wildlife Service, “Peregrine Falcon (*Falco peregrines*),” U.S. Department of the Interior, Washington, D.C., May 2006.

USFWS, 2009a, U.S. Fish and Wildlife Service, “Listed and Sensitive Species in Lea County,” New Mexico Ecological Services Field Office, 2009.

http://www.fws.gov/southwest/es/newmexico/SBC_view.cfm?spcnty=Lea

USFWS, 2009b, U.S. Fish and Wildlife Service, “Black-Footed Ferret (*Mustela nigripes*),” 2009.
<http://www.fws.gov/audobon/audnwr2.htm> ,
<http://ecos.fws.gov/speciesProfile/speciesReport.do?spcode=A004>

USGS, 1976. U.S. Geological Survey, “A Probabilistic Estimate of Maximum Ground Acceleration in Rock in the Contiguous United States,” S.T. Algermissen and D.M. Perkins, Open File Report 76-416, p. 44, U.S. Department of the Interior, Washington, D.C., 1976.

USGS, 1986. U.S. Geological Survey, “Land Use and Land Cover Digital Data from 1:250,000 – Scale Maps, National Mapping Program,” U.S. Department of the Interior, Washington, D.C., 1986.

USGS, 1997. U. S. Geological Survey, “Seismic Hazard Maps for the Conterminous United States,” A.C. Frankel et al., Open-File Report 97-130, 12 maps, U.S. Department of the Interior, Washington, D.C., 1997. http://earthquake.usgs.gov/research/hazmaps/products_data/1996/uncertainties/nceer.htm

USGS, 2002a. U. S. Geological Survey, “Earthquake Catalog, 1973 – Present,” National Earthquake Information Center, U.S. Department of the Interior, Washington, D.C., 2002.

USGS, 2002b. U.S. Geological Survey, “National Seismic Hazard Mapping Project,” U.S. Department of the Interior, Washington, D.C., 2002.

USGS, 2004a. U.S. Geological Survey, Earthquake Hazards Program, Quaternary Fault and Fold Database of the United States, U.S. Department of the Interior, Washington, D.C., 2004.
<http://earthquake.usgs.gov/regional/states/index.php?regionID=31>

USGS, 2004b. U.S. Geological Survey, “High Plains Regional Ground Water (HPGW) Study,” National Water Quality Assessment Program, U.S. Department of the Interior, Washington, D.C., January 15, 2004.

USGS, 2005. U.S. Geological Survey, The Southwest Regional Gap Analysis Project, Final Report on Land Cover Mapping Methods, U.S. Department of the Interior, Washington, D.C., October 13, 2005.

USGS, 2009a. U.S. Geological Survey, Bell's Vireo, Life History Groupings, U.S. Department of the Interior, Washington, D.C., 2009.

USGS, 2009b. U.S. Geological Survey, High Plains Regional Ground-water Study, U.S. Department of the Interior, Washington, D.C., 2009.

<http://co.water.usgs.gov/nawqa/hpgw/factsheets/DENNYHYFSI.html>

Weber, 2008. Neil Weber & Associates, Regional Seismological Evaluation, Hobbs, New Mexico, December 17, 2008.

WEST, 2002. Westinghouse TRU Solutions LLC, Waste Isolation Pilot Plant 2001 Site Environmental Report, DOE/WIPP 02-2225, September 2002.

WildEarth Guardians, 2008. WildEarth Guardians, "Lesser Prairie Chicken: A Decade in Purgatory," Santa Fe, New Mexico, June 9, 2008.

http://www.wildearthguardians.org/Portals/0/support_docs/report_esser-prarie-chicken_6-9-08.pdf

WRCC, 2003. Western Regional Climate Center, Hobbs, New Mexico, NCDC 1971-2000 Monthly Normals, Desert Research Institute, 2003.

WRCC, 2006. Western Regional Climate Center, "Climate Summary for Hobbs New Mexico,"

<http://wrcc.dri.edu/narratives/NEWMEXICO.htm> ; <http://www.wrcc.dri.edu/cgi-bin/cl:MONtmxt.pl?nm4026>

WRCC, 2009. Western Regional Climate Center, Western U.S. Precipitation Frequency Maps, 2009. <http://www.wrcc.dri.edu/pcpnfreq.html>

WRDC, 2008. Population Brief, Trends in the Western U.S., Don E. Albrecht, Western Rural Development Center, Utah State University, Logan, Utah, 2008.

http://extension.usu.edu/files/publications/publication/pub_4114325.pdf

WSG, 2004. Window on State Government, Texas County Population Projections, 2000 to 2030: Total Population, 2004. <<http://www/>

Yarger, 2009. F. Yarger, Seismic Probability in Lea County, NM: A Brief Analysis, New Mexico Institute of Mining and Technology, New Mexico Center for Energy Policy, Socorro, NM, 2009.

Yücel, 2003. Mine K. Yücel and John Thompson, "Texas Economy Warming Up in 2003, Southwest Economy," Federal Reserve Bank of Dallas, pp. 11-14, July/August 2003.

10. LIST OF PREPARERS

Don Chumbler: Environmental Report Preparer/Reviewer

Education: B.A., Chemistry and Mathematics, and continuing graduate studies in Chemistry, Certified Quality Manager, American Society of Quality
Experience: 40 years in uranium enrichment with experiences in technical and engineering evaluation, health physics management and quality assurance development and implementation.

Marshall Shepherd: Environmental Report Preparer/Reviewer

Education: BS and MS, Chemistry and Masters, Business Administration
Experience: More than 32 years technical and management experience in UF₆, fluorine and fluorine products. Seven of those years ESH and regulatory manager for Honeywell uranium/fluoride specialty chemicals

Jim Thomas: Environmental Report Preparer/Reviewer

Education: BS, Chemistry, MS, Engineering Technology and Masters, Business Administration
Experience: More than 30 years of technical, process engineering, environmental, safety and health (ESH), regulatory and management experience in the uranium nuclear fuel cycle industry. Eleven (11) of those years were in uranium conversion as a process engineer, corporate process technology manager and plant manager in the commercial production of uranium hexafluoride, fluorine and specialty fluorine chemicals. More than 17 years in uranium enrichment with responsibilities for operations, management, maintenance, and corporate manager of advanced technology development and engineering. Six (6) years experience in the nuclear fuel cycle as ESH and regulatory manager.

Tommy Thompson: Environmental Report Preparer/Reviewer

Education: BS, Mechanical Engineering, MS, Engineering Technology and Licensed Professional Engineer (PE)
Experience: More than 30 years in design, engineering and project management of industrial and commercial facilities and processes.

Ron Green; Environmental Report Preparer

Education: BS, Nuclear Engineering
Experience: 20 years criticality safety, facility safety, safety analysis (ISA) and risk assessment, operational readiness, fissile material transportation, radiological engineering, chemical/nuclear process Engineering supporting the project as lead in conducting an integrated safety analysis (ISA) and accident analysis and in developing and preparing safety assessment documentation.

Gary Holland: Environmental Report Preparer

Education: BS, Mechanical Engineering, and Licensed Professional Engineer (PE)
Experience: More than 30 years in chemical and uranium enrichment industry with experiences in process and project engineering, maintenance, engineering design, capital and engineering cost estimating, procurement engineering and site selection studies. For over five (5) was design authority for uranium enrichment advanced technology development.

Carol Mason: Environmental Report Preparer

Education: BS and MS, Chemical Engineering
Experience: Over 33 years of experience in safety analysis, reliability analysis, and risk assessment for nuclear and non-nuclear facilities supporting the project in conceptual process engineering, integrated safety and accident analysis, and licensing evaluations and documentation.

Tamela Wheeler: Environmental Report Preparer

Education: BS, Physics, MS, Health Physics and Certified Health Physicist

Experience: Over 13 years as radiation safety officer, senior health physicist and senior engineer, leading development of the radiological protection assessment and plan and the dose modeling work for the project and supporting accident analysis, integrated safety analysis, chemical safety assessments and the environmental assessment work.

Jeff Schmidt: Environmental Report Preparer

Education: BS, Mechanical Engineering

Experience: Over 15 years as a mechanical engineer supporting engineering and conceptual design.

W. Allen Burnett: Licensing Application and Environmental Report Reviewer

Education: BS and MS in Mechanical Engineering, Licensed Professional Engineer (PE)

Experience: Has over 30 years experience in uranium enrichment and enrichment technical services. Twelve of the 30 years experience are in nuclear safety analysis.

APPENDIX A: GLOSSARY

100-year flood: Refers to a flood elevation (for a given area) that has a 1% chance of being equaled or exceeded each year. The term 100-year flood is synonymous with the 1% annual chance flood.

500-year flood: Refers to the flood elevation for a given area that has a 0.2% chance of being equaled or exceeded each year. This term is synonymous with the 0.2% annual chance flood.

Absorbed Dose: The energy imparted to matter by ionizing radiation. The unit of absorbed dose is the rad.

Activity: A measure of the rate at which a material emits nuclear radiation, usually given in terms of the number of nuclear disintegrations occurring in a given length of time. The common unit of activity is the curie, which amounts to 37 billion disintegrations per second. The International Standard unit of activity is the Becquerel and is equal to one disintegration per second.

Air pollutant: Any substance in air which could, if in high enough concentration, harm humans, other animals, vegetation, or material. Pollutants may include almost any natural or artificial composition of matter capable of being airborne.

Air quality: A measure of the quantity of pollutants, measured individually, in the air. These levels are often compared to regulatory standards.

Air quality standards: The level of pollutants in the air prescribed by regulations that may not be exceeded during a specified time in a defined area. Air quality standards are used to provide a measure of the health-related and visual characteristics of the air.

ALARA: Acronym for "as low as (is) reasonably achievable." An approach to keep radiation exposures (both to the workforce and the public) and releases of radioactive material to the environment at levels that are as low as social, technical, economic, practical, and public policy considerations allow. ALARA is not a dose limit; it is a practice whose objective is the attainment of dose levels as far below applicable limits as possible.

Alluvium: Clay, silt, sand, and/or gravel deposits found in a stream channel or in low parts of a stream valley that is subject to flooding. Ancient alluvium deposits frequently occur above the elevation of present-day streams.

Alpha particle: A positively charged particle emitted in the radioactive decay of certain nuclides. Made up of two protons and two neutrons bound together, it is identical to the nucleus of a helium atom.

Alternative site: A ranked site, other than the proposed site, that was evaluated in the fine-screening step.

Ambient air: The surrounding atmosphere, usually the outside air, as it exists around people, plants, and structures. It is not the air in immediate proximity to emission sources.

Ambient Air Quality Standards: Standards established on a State or Federal level, that define the limits for airborne concentrations of designated "criteria" pollutants (nitrogen dioxide, sulfur dioxide, carbon

monoxide, total suspended particulates, ozone, and lead), to protect public health with an adequate margin of safety (primary standards) and to protect public welfare, including plant and animal life, visibility, and materials (secondary standards).

Ambient Sound Level: A sound level that represents the background noise from community or **environmental** sound sources.

Amplification: The process by which soils and sediments near the surface modify ground shaking during earthquakes by reducing the velocity of earthquake waves and increasing their amplitude.

Aqueous: Related to water.

Aquifer: Geologic unit sufficiently permeable to conduct groundwater.

Area of potential effects: The geographic area or areas within which an undertaking may directly or indirectly cause alterations in the character or use of historic properties, if any such properties exist. The area of potential effects is influenced by the scale and nature of an undertaking and may be different for different kinds of effects caused by the undertaking

Assay: The qualitative or quantitative analysis of a substance often used to determine the proportion of isotopes in radioactive materials.

Atmosphere: The layer of air surrounding the earth.

Atmospheric Dispersion: Movement of a contaminant as a result of the cumulative effect of the random motions of the air. Equivalent to eddy diffusion.

Atom: Smallest unit of an element that is capable of entering into a chemical reaction and displays the other properties of the element.

Atomic Energy Act of 1954 as amended: A federal law that created the Atomic Energy Commission, which later split into the Nuclear Regulatory Commission and the Energy and Research and Development Administration (ERDA). ERDA became part of the Department of Energy in 1977. This act encouraged the development and use of nuclear energy and research for the general welfare and the security of the United States. This act authorized the Nuclear Regulatory Commission to regulate and license fuel fabrication facilities that seek to receive, possess, use, or transfer special nuclear material.

Attainment area: A region that meets the U.S. EPA National Ambient Air Quality Standards (NAAQS) for a criteria pollutant under the *Clean Air Act*.

Backfill: Materials, such as salt or a mixture of salt and other materials, used to reduce void volumes in storage panels or drifts.

Background radiation: Radiation from: (1) naturally occurring radioactive materials, as they exist in nature prior to removal, transport, or enhancement or processing by man; (2) cosmic and natural terrestrial radiation; (3) global fallout as it exists in the environment; (4) consumer products containing nominal amounts of radioactive material or emitting nominal levels of radiation; and (5) radon and its progeny in concentrations or levels existing in buildings or the environment that have not been elevated as a result of current or past human activities.

Baseline: A quantitative expression of conditions, costs, schedule, or technical progress to serve as a base or standard for measurement during the performance of an effort; the established plan against which the status of resources and the progress of a project can be measured.

Basin: A topographic or structurally low area compared to the immediately adjacent areas.

Berm: An earthen embankment; a long artificial mound of stone or earth similar to a dike or levee.

Best Management Practices (BMP): Structural, nonstructural, and managerial techniques recognized to be the most effective and practical means to reduce surface water and groundwater contamination while still allowing the productive use of resources.

Beta particle: A charged particle emitted from a nucleus during radioactive decay, with a mass equal to 1/1837 that of a proton. A negatively charged beta particle is identical to an electron. A positively charged beta particle is called a positron. Large amounts of beta radiation may cause skin burns, and beta emitters are harmful if they enter the body. Beta particles may be stopped by thin sheets of metal or plastic.

Biotic community: A group of organisms living and interacting within the same habitat.

Bounding: That which represents the maximum reasonably foreseeable event or impact. All other reasonably foreseeable events or impacts would have fewer and/or less severe environmental consequences.

Buffer area: A designated area of land that is designed to permanently remain vegetated in an undisturbed and natural condition in order to protect an adjacent aquatic or wetland site from upland impacts and to provide habitat for wildlife.

Carbon monoxide: An odorless, colorless, poisonous gas produced by incomplete burning of carbon in fuels. Exposure to carbon monoxide reduces the delivery of oxygen to the body's organs and tissues. Elevated levels can cause impairment of visual perception, manual dexterity, learning ability, and performance of complex tasks.

Caliche: Calcium carbonate (CaCO₃) deposited in the soils of arid or semiarid regions.

Cancer: Any malignant new growth of abnormal cells or tissue.

Carcinogen: An agent capable of producing or inducing cancer.

Cenozoic: An era of geologic time, from the beginning of the Tertiary period to the present; considered to have begun about 65 million years ago.

Census block: The smallest geographic unit used by the U.S. Census Bureau for tabulation of 100% data (data collected from all houses, rather than a sample of houses). Several Census blocks make up Census Block Groups, which can be combined to create census tracts.

Census tract: An area usually containing between 2,500 and 8,000 persons that is used for organizing and monitoring census data. The geographic dimensions of census tracts vary widely, depending on population density. Census tracts do not cross county borders.

Chemical equilibrium: The state of a reaction in which its forward and reverse reactions occur at equal rates so that the concentrations of the reactants do not change with time.

Class Y: Refers to the retention time of radioactive material in the pulmonary region of the lung. The classification of Y applies to a range of clearance half-times of greater than 100 days.

Clean Air Act: A Federal law that requires the EPA to set and enforce air pollutant emissions standards for stationary sources and motor vehicles.

Climatology: The science devoted to the study of the conditions of the natural environment (rainfall, daylight, temperature, humidity, air movement) prevailing in specific regions of the earth.

Code of Federal Regulations (CFR): All Federal regulations in force are published in codified form in the *Code of Federal Regulations*.

Committed dose equivalent: The predicted dose equivalent to a tissue or organ over a 50-year period after an intake of a radionuclide into the body. It does not include dose contributions from radiation sources external to the body. Committed dose equivalent is expressed in units of rem (or sievert). (1 rem = 0.01 sievert).

Committed effective dose equivalent: The sum of the committed dose equivalents to various organs or tissues in the body from radioactive material taken into the body, each multiplied by the tissue-specific weighting factor. Committed effective dose equivalent is expressed in units of rem (or sievert).

Community: A group of people or a site within a spatial scope exposed to risks that potentially threaten health, ecology, or land values, or exposed to industry that stimulates unwanted noise, odors, industrial traffic, particulate matter, or other nonaesthetic impacts.

Concentration: The amount of a substance contained in a unit quantity (mass or volume) of a sample.

Confined aquifer: An aquifer bounded above and below by impermeable beds, or by beds of distinctively lower permeability than that of the aquifer itself, allowing the groundwater to be under pressure; an aquifer containing confined water.

Conservative: When used with predictions or estimates, leaning on the side of pessimism. A conservative estimate is one in which the uncertain inputs are used in the way that provides a reasonable upper limit of the estimate of an impact.

Consumptive use: Water use where the water is withdrawn from the source and not returned.

Containment: Retention of a material or substance within prescribed boundaries.

Contamination: The presence of excess radioactive material from an activity in or on a material or property.

Cooling water: Water circulated through a nuclear reactor or processing plant to remove heat.

Cosmogenic: Produced by the action of rays that come from outer space.

Cost-benefit analysis: A formal quantitative procedure comparing costs and benefits of a proposed project or act under a set of pre-established rules.

Council on Environmental Quality: The President's Council on Environmental Quality (CEQ) was established by the enactment of *National Environmental Policy Act* (NEPA). The CEQ is responsible for developing regulations to be followed by all federal agencies in developing and implementing their own specific NEPA implementation policies and procedures.

Criteria pollutants: Six pollutants (ozone, carbon monoxide, total suspended particulates, sulfur dioxide, lead, and nitrogen oxide) known to be hazardous to human health and for which the U.S. Environmental Protection Agency sets National Ambient Air Quality Standards under the *Clean Air Act*.

Critical habitat: The specific areas within the geographical area occupied by a species at the time it is listed as threatened or endangered on which are found those physical or biological features that are essential to the conservation of the species and that may require special management considerations or protection. It also includes specific areas outside the geographical area occupied by the species at the time it is listed if these areas are determined to be essential for the conservation of the species.

Cultural resources: Archaeological sites, architectural features, traditional use areas, and Native American sacred sites or special use areas.

Cumulative impacts: Cumulative impacts are those impacts on the environment that result from the incremental impact of the action when added to other past, present, and reasonably foreseeable future actions regardless of what agency (federal or non-federal) or person undertakes such other actions. Cumulative impacts can result from individually minor but collectively significant actions taking place over a period of time.

Curie: A unit of radioactivity equal to 37 billion (3.7×10^{10}) disintegrations per second.

Day-night Average Sound Level (LDN): A sound level that represents the average sound level during daytime hours and nighttime hours, with the nighttime hours having a 10 dB increase to represent the higher sensitivity of humans at those hours.

Decibel (dB): A standard unit for measuring sound-pressure levels based on a reference sound pressure of 0.0002 dyne per square centimeter. This is the smallest sound a human can hear. In general, a sound doubles in loudness with every increase of slightly more than 3 decibels.

Decibel, A-weighted (dBA): A number representing the sound level which is frequency weighted according to a prescribed frequency response established by the American National Standards Institute and accounts for the response of the human ear.

Decommissioning: The removal from active service of a facility.

Decontamination: The reduction or removal of contaminating radioactive material from a structure, area, object, or person. Decontamination may be accomplished by (1) treating the surface to remove or decrease the contamination, (2) letting the material stand so that the radioactivity is decreased as a result of natural radioactive decay, or (3) covering the contamination to shield or attenuate the radiation emitted

Delaware Basin: An area in southeastern New Mexico and the adjacent parts of Texas where the Permian sea deposited a large thickness of evaporites some 220 to 280 million years ago. It is partially surrounded by the Capitan Reef.

Depleted uranium: Uranium having a percentage of uranium-235 smaller than the 0.7 percent found in natural uranium. It is obtained from spent (used) fuel elements or as byproduct tails, or residues, from uranium isotope separation.

Depleted uranium hexafluoride (DUF₆): A compound of uranium and fluorine from which most of the uranium-235 isotope has been removed.

Design life: The design life of components or systems generally refers to the estimated minimum period of time that the component or system is expected to perform within specifications before the effects of aging result in performance deterioration or a requirement to replace the component or system.

Diffusion: Movement of atoms, ions, or molecules of one substance into or through another as a result of thermal or concentration gradients.

Direct jobs: The number of workers required at a site to implement an alternative.

Distribution coefficient: In an aquifer, the ratio of the concentration of a substance absorbed by the rock to the concentration of the substance remaining in solution. A large distribution coefficient implies that the substance moves much more slowly than the groundwater. It is measured in units of cubic centimeters per gram or equivalent.

Dose (absorbed dose): The energy imparted to matter per unit mass by ionizing radiation. The unit of absorbed dose is the rad (or gray [Gy]). It is used as a general term for dose equivalent, total effective dose equivalent, and committed dose equivalent.

Dose conversion factor: A numerical factor used in converting radionuclide intake (curies) in the body to the resultant dose equivalence (rem or person-rem).

Dose equivalent: The product of absorbed dose in rad (or gray) in tissue and a quality factor. Dose equivalent is expressed in units of rem (or sievert).

Dose rate: The radiation dose delivered per unit time (e.g., rem per hour).

Dosimetry: The theory and application of the principles and techniques involved in the measurement and recording of radiation doses. Its practical aspect is concerned with the use of various types of radiation instruments with which measurements are made (i.e., film badge, thermoluminescent dosimeter, and Geiger counter).

Ecology: The science dealing with the relationship of all living things with each other and with the environment.

Ecoregion: A classification of land based on similar climate, vegetation, and topography.

Economic: A distinctive part of the economy of a geographic region defined by a sector standard industrial classification scheme. One such scheme defines "major" sectors and divides them into

subsectors; for example, the major sector “trade” contains the subsectors “wholesale trade” and “retail trade.” Another classification scheme specifies “primary” and “secondary” sectors; the criterion for including a sector in the primary classification is that its level of activity is generally not controlled by the level of economic activity in the region; a primary industry, in other words, produces goods and services for export from the region.

Effective dose equivalent: The sum of the products of the dose equivalent received by specified organs or tissues of the body and a tissue-specific weighting factor. The effective dose equivalent is expressed in units of rem (or sievert).

Effluent: A gas or fluid discharged into the environment, treated or untreated. Most frequently, the term applies to wastes discharged to surface waters.

EIS: Environmental impact statement; a document required by the National Environmental Policy Act for proposed major Federal actions involving potentially significant environmental impacts.

Element: One of the known chemical substances that cannot be divided into simpler substances by chemical means.

Emissions: Substances that are discharged into the air.

Emission standards: Legally enforceable limits on the quantities and/or kinds of air contaminants that can be emitted into the atmosphere.

Endangered species: Plants and animals that are threatened with extinction, serious depletion, or destruction of critical habitat. Requirements for declaring a species endangered are contained in the Endangered Species Act.

Endangered Species Act of 1973: An act requiring federal agencies, with the consultation and assistance of the Secretaries of the Interior and Commerce, to ensure that their actions will not likely jeopardize the continued existence of any endangered or threatened species or adversely affect the habitat of such species.

Energy: The capacity for doing work.

Environment: The sum of all external conditions and influences affecting the life development and, ultimately, the survival of an organism.

Environmental justice: The fair treatment of people of all races, cultures, incomes, and educational levels with respect to the development, implementation, and enforcement of environmental laws, regulations, and policies. Fair treatment implies that no population of people should be forced to shoulder a disproportionate share of the negative environmental impacts of pollution or environmental hazards due to a lack of political or economic strength.

Environmental monitoring: The act of measuring, either continuously or periodically, some quantity of interest, such as radioactive material in the air.

Eocene: An epoch of the Tertiary period, occurring from 55 to 40 million years ago and characterized by the advent of the modern mammalian orders.

Ephemeral stream: A stream channel that carries water only during part of the year, immediately after periods of rainfall or snowmelt.

Equilibrium: A state of rest in a chemical or mechanical system.

ER: Environmental Report required as part of an environmental assessment, which identifies, describes and evaluates the likely significant effects on the environment of implementing a plan or program.

Erosion: Removal and transport of materials by wind, ice, or water on the earth's surface.

Escarpment: A long, nearly continuous cliff or relatively steep slope facing in one general direction, breaking the continuity of the land by separating two level or gently sloping surfaces, and produced by erosion or faulting.

Evapotranspiration: Loss of water from the earth's surface to the atmosphere by a combination of evaporation from the soil, lakes, streams, and transpiration from plants.

Exposure: Measure of the ionization produced in air by X or gamma radiation. It is the sum of the electrical charges on all ions of one sign produced in air when all electrons liberated by photons in a volume element of air are completely stopped in air, divided by the mass of the air in the volume element.

Exposure limit: The level of exposure to a hazardous chemical (set by law or a standard) at which or below which adverse human health effects are not expected to occur:

Exposure pathways: A route or sequence of processes by which a radioactive or hazardous material may move through the environment to humans or other organisms. Each exposure pathway includes a source or release from a source, an exposure point, and an exposure route.

Fault: A fracture or a zone of fractures along which there has been displacement parallel to the fracture.

Fission (nuclear): The splitting of a heavy nucleus typically into two approximately equal parts (infrequently three parts), which are nuclei of lighter elements, accompanied by the release of energy and generally one or more neutrons. Fission can occur spontaneously or can be induced by nuclear bombardment.

Floodplain: Low-lying areas adjacent to rivers and streams that are subject to natural inundations typically associated with precipitation.

Formation: A mappable geologic body of rock identified by lithic characteristics and stratigraphic position. Formations may be combined into groups or subdivided into members.

Fuel cycle: The series of steps involved in supplying fuel for nuclear power reactors. It can include mining, milling, isotopic enrichment, fabrication of fuel elements, use in a reactor, chemical reprocessing to recover the fissionable material remaining in the spent fuel, re-enrichment of the fuel material, re-fabrication into new fuel elements, and waste disposal.

Fugitive Dust: Any solid particulate matter (PM) that becomes airborne, other than that emitted from an exhaust stack, directly or indirectly as a result of the activities of man. Fugitive dust may include emission

from haul roads, wind erosion of exposed soil surfaces, and other activities in which soil is either removed or redistributed.

Gamma: Short-wavelength electromagnetic radiation (high-energy photons) emitted in the radioactive decay of certain nuclides. Gammas are the same as gamma rays or gamma waves.

Gaussian plume: The distribution of material (a plume) in the atmosphere resulting from the release of pollutants from a stack or other source. The distribution of concentrations about the centerline of the plume, which is assumed to decrease as a function of its distance from the source and centerline (Gaussian distribution), depends on the mean wind speed and atmospheric stability.

Geology: The science that deals with the earth; the materials, processes, environments, and history of the planet, especially the lithosphere, including the rocks, their formation, and structure.

Geology and Soils: Those Earth resources that may be described in terms of landforms, geology, and soil conditions.

Glovebox: An airtight box used to work with hazardous material, vented to a closed filtering system, having gloves attached inside of the box to protect the worker.

Gray (Gy): The international system (SI) unit of absorbed dose. One gray is equal to an absorbed dose of 1 Joule/kilogram (one gray equals 100 rads)

Gross alpha: The total rate of alpha particle emission from a sample, without regard to energy distribution or source nuclides.

Gross beta: The total rate of emission of beta particles from a sample, without regard to energy distributions or source nuclides.

Groundwater: All subsurface water, especially that contained in the saturated zone below the water table.

Habitat: The part of the physical environment in which a plant or animal lives.

Half-life: Time required for a radionuclide to lose 50 percent of its activity by decay. Each radionuclide has a unique half-life; that is, half of a particular radionuclide will decay in a specified amount of time; then half of the remaining portion will decay in the same amount of time, and so on. Half-life can also refer to the length of time that a chemical/radionuclide/ biological agent remains in the body. Each material has biologically unique half-lives, depending on the substance, the organ of concern, and its route of elimination.

Hazard index: An indicator of the potential toxicological hazard from exposure to a particular substance. The hazard index is equal to an individual's estimated exposure divided by the U.S. Environmental Protection Agency's substance-specific reference dose.

Hazardous chemical: Under 29 CFR Part 1910, Subpart Z, "hazardous chemicals" are defined as "any chemical, which is a physical hazard or a health hazard." Physical hazards include combustible liquids, compressed gases, explosives, flammables, organic peroxides, oxidizers, pyrophorics, and reactives. A health hazard is any chemical for which there is good evidence that acute or chronic health effects occur

in exposed employees. Hazardous chemicals include carcinogens, toxic or highly toxic agents, reproductive toxins, irritants, corrosives, sensitizers, hepatotoxins, nephrotoxins, agents that act on the hematopoietic system, and agents that damage the lungs, skin, eyes or mucous membranes.

Hazardous waste: According to the *Resource Conservation and Recovery Act*, a waste that, because of its characteristics, may (1) cause or significantly contribute to an increase in mortality or an increase in serious irreversible illness, or (2) pose a substantial hazard to human health or the environment when improperly treated, stored, transported, disposed of, or otherwise managed. Hazardous wastes possess at least one of the following characteristics: ignitability, corrosivity, reactivity, or toxicity. Hazardous waste is nonradioactive.

Head: When used in a hydraulic sense, it is understood to mean static head. The static head is the height above a standard datum of the surface of a column of water (or other liquid) that can be supported by the static pressure at a given point.

Herbaceous: Non-woody vegetation.

Heels: In the uranium enrichment process, heels refer to the residual solid uranium hexafluoride left after the feed rate declines to a predetermined level.

High efficiency particulate air filter: This filter is designed to remove 99.9 percent of particles as small as 0.3 micrometer in diameter from a flowing air stream.

Historic Resources: The sites, districts, structures, and objects associated with historic events, persons, or social or historic movements.

Historic and Cultural Resources: Cultural resources include any prehistoric or historic district, site, building, structure, or object resulting from, or modified by, human activity. Historic properties are cultural resources listed in, or eligible for listing in, the National Register of Historic Places.

Holding ponds: Engineered depressions in the land that contain storm-water runoff until it can slowly seep back into the ground or evaporate.

Holocene: An epoch of the Quaternary period, from the end of the Pleistocene, approximately 10,000 years ago, to the present time; also known as the Recent period.

Hydraulic conductivity: A quantity that describes the rate at which water flows through an aquifer. It has units of length/time and is equal to the hydraulic transmissivity divided by the thickness of the aquifer.

Hydraulic gradient: A quantity that describes the rate of change of pressure head per unit of distance of flow at a given point and in a given direction.

Immediately dangerous to life and health (IDLH): A term that represents a maximum airborne concentration from which one could escape within 30 minutes without any escape-impairing symptoms or any irreversible health effects.

Impacts: An assessment of the meaning of changes in all attributes being studied for a given resource. An aggregation of all of the adverse effects, usually measured using a qualitative and nominally subjective technique.

Indirect effects: Those effects that would not directly destroy the physical integrity of a significant cultural resource, but would either adversely affect an element or elements that contribute to the significance of the resource or would increase the risk of destruction by outside action.

Indirect jobs: Jobs generated or lost in related industries within a regional economic area as a result of a change in direct employment.

Ingestion: To take in by mouth. Material that is ingested enters the digestive system.

Inhalation: To take in by breathing. Material that is inhaled enters the lungs.

In situ: In the natural or original position; i.e., in place.

Integrated Safety Analysis (ISA): A formalized and documented process that identifies potential accident sequences in a plant's operations, designates items relied on for safety to either prevent such accidents or mitigate their consequences to an acceptable level, and describes management measures to provide reasonable assurance of the availability and reliability of items relied on for safety.

Intensity (earthquake): a measure of the effects of an earthquake on humans and structures at a particular place. It is measured in numerical units on the modified Mercalli scale.

Interbed: A bed of one kind of rock occurring between or alternating with beds of another rock type.

Intermittent: A feature that contains water for only part of the year, typically during winter and spring, when the aquatic bed is below the water table. An intermittent stream often lacks the biological and hydrological characteristics commonly associated with the conveyance of water.

Ionization: The process that creates ions. Nuclear radiation, X-rays, high temperatures, and electric discharges can cause ionization.

Ionizing radiation: Radiation capable of displacing electrons from atoms or molecules to produce ions.

Isotope: An atom of a chemical element with a specific atomic number and atomic weight. Isotopes of the same element have the same number of protons but different numbers of neutrons. Isotopes are identified by the name of the element and the total number of protons and neutrons in the nucleus. For example, uranium-235 is an isotope of uranium with 92 protons and 143 neutrons and uranium-238 is an isotope of uranium with 92 protons and 146 neutrons.

Karst: A topography characterized by sinkholes, caves, and disappearing streams formed by dissolution in limestone, dolomite, and evaporite bedrock.

Land Use: The way land is developed and used in terms of the kinds of anthropogenic activities that occur (e.g., agriculture, residential areas, industrial areas).

Latent cancer fatalities: Deaths resulting from cancer that has become active after a latent period following radiation exposure. Latent cancer fatalities can be calculated for the public by using the risk conversion factor of 5×10^{-4} deaths per person rem and for the worker by using the risk conversion factor of 4×10^{-4} deaths per person-rem.

Leaching: The process of extracting a soluble component from a solid by the percolation of a solvent, such as water, through the solid.

Lead: A heavy metal element formerly added to gasoline and paint for improved performance characteristics. Lead can be inhaled and ingested in food, water, soil, or dust. High exposure to lead can cause seizures, mental retardation, and/or behavioral disorders. Low exposure to lead can lead to central nervous system damage.

Lithic: A cultural artifact made of stone.

Lithologic: The character of a rock described in terms of its structure, color, mineral composition, grain size, and arrangement of its component parts; all those visible features that in the aggregate impart individuality to the rock.

Loam: A rich, friable soil containing a relatively equal mixture of sand and silt and a somewhat smaller proportion of clay.

Low-enriched uranium (LEU): Uranium enriched in the isotope uranium-235, greater than 0.7 percent but less than 20 percent of the total mass. Naturally occurring uranium contains about 0.7 percent uranium-235, almost all the rest is uranium-238.

Low-level mixed waste: Low-level waste that also contains hazardous chemical components regulated under the *Resource Conservation and Recovery Act*.

Low-level radioactive waste: Wastes containing source, special nuclear, or by-product material are acceptable for disposal in a land disposal facility. For the purposes of this definition, low-level waste has the same meaning as in the *Low-Level Radioactive Waste Policy Act*, that is, radioactive waste not classified as high-level radioactive waste, transuranic waste, spent nuclear fuel, or by-product material as defined in section 11e.(2) of the *Atomic Energy Act* (uranium or thorium tailings and waste).

Low-income population: A population where 25 percent or more of the population is identified as living in poverty.

Magnitude (earthquake): A measure of the total energy released by an earthquake. It is commonly measured in numerical units on the Richter scale. Each unit, e.g. 7, is different from an adjacent unit by a factor of 30.

Maximally exposed individual (MEI): A hypothetical person who—because of proximity, activities, or living habits—could receive the highest possible dose of radiation or of a hazardous chemical from a given event or process.

Meteorology: The science dealing with the atmosphere and its phenomena, especially as relating to weather.

Mesozoic: An era of geologic time, from the end of the Paleozoic era to the beginning of the Cenozoic era, or from about 225 million years to about 65 million years ago.

Microcurie: One millionth of a curie. That amount of radioactive material that disintegrates (decays) at the rate of 37 thousand atoms per second.

Migration: The natural travel of a material through the air, soil, or groundwater.

Millirem (mrem): One thousandth of a rem (0.001 rem).

Mitigation: A series of actions implemented to ensure that projected impacts will result in no net loss of habitat value or wildlife populations. The purpose of mitigative actions is to avoid, minimize, rectify, or compensate for any adverse environmental impact.

Mixed waste: Waste that contains both "hazardous waste" and "radioactive waste" as defined in this glossary.

Mixing height: The height above the earth's surface through which relatively strong vertical mixing of the atmosphere occurs.

Modified Mercalli Intensity: A measurement of earthquake intensity based on the effects to people and structures. Ranges from I (low) to XII (total destruction), as opposed to the Richter scale, which measures the energy of the earthquake. Mercalli scale is often used to classify earthquakes that were not recorded on modern seismographs.

Molecular weight: The weight of a molecule of a chemical expressed in atomic mass units.

National Ambient Air Quality Standards (NAAQS): Air quality standards established by the *Clean Air Act*, as amended. The primary NAAQS are intended to protect the public health with an adequate margin of safety, and the secondary NAAQS are intended to protect the public welfare from any known or anticipated adverse effects of a pollutant.

National Emission Standards for Hazardous Air Pollutants (NESHAP): Emission standards for the control of releases of specified hazardous air pollutants, including radionuclides. These were implemented in the *Clean Air Act* Amendments of 1977.

National Environmental Policy Act (NEPA) of 1969: A federal law constituting the basic national charter for protection of the environment. The act calls for the preparation of an environmental impact statement (EIS) for every major federal action that may significantly affect the quality of the human or natural environment. The main purpose is to ensure that environmental information is provided to decision makers so that their actions are based on an understanding of the potential environmental and socioeconomic consequences of a proposed action and the reasonable alternatives.

National Historic Preservation Act (NHPA): A federal law providing that property resources with significant national historic value be placed on the National Register of Historic Places. It does not require permits; rather, it mandates consultation with the proper agencies whenever it is determined that a proposed action might impact a historic property.

National Land Cover Dataset (NLCD): National dataset that depicts land cover based on categories, including open water, perennial ice/snow, open space developed, low intensity developed, medium intensity developed, high intensity developed, barren land, deciduous forest, evergreen forest, mixed forest, scrub/shrub, grassland/herbaceous, pasture/hay, cultivated crops, woody wetlands, and emergent herbaceous wetlands.

National Pollutant Discharge Elimination System (NPDES): Federal permitting system required for any discharges to waters of the United States regulated through the *Clean Water Act*, as amended.

National Register of Historic Places: A list maintained by the National Park Service of architectural, historic, archaeological, and cultural sites of local, state, or national importance.

Natural Resources Conservation Service: An organization within the U.S. Department of Agriculture aimed at helping America's private land owners and managers conserve their soil, water, and other natural resources.

Non-Attainment Areas: An area that has been designated by the Environmental Protection Agency, or the appropriate state air quality agency, as exceeding one or more national or state Ambient Air Quality Standards.

Non-consumptive use: Water use where the water is withdrawn from the source and returned.

Normal operations: Conditions during which facilities and processes operate as expected or designed. In general, normal operations include the occurrence of some infrequent events that, although not considered routine, are not classified as accidents

NO_x: Oxides of nitrogen, primarily nitrogen oxide and nitrogen dioxide. These are produced primarily by combustion of fossil fuels, and can constitute an air pollution problem.

Nuclide: A species of atom, characterized by its number of protons, number of neutrons, and energy state.

Off-site: Area outside the property boundary (or outside the fence line) of a facility.

On-site: Area inside the property boundary (or inside the fence line) of a facility.

Order of magnitude: A multiple of ten. When a measurement is made with a result such as 3×10^7 , the exponent of 10 is the order of magnitude of that measurement. To say that this result is known to within an order of magnitude is to say that the true value lies between 3×10^6 and 3×10^8 .

Organic compounds: Of or designating carbon compounds. (Some simple compounds of carbon, such as carbon dioxide, are frequently classified as inorganic compounds.)

Outfall: The place where effluent is discharged into receiving waters.

Oxide: A compound consisting of an element combined with oxygen.

Ozone: A molecule of oxygen in which three oxygen atoms are chemically attached to each other.

Package: In the regulations governing the transportation of radioactive materials, the packaging together with its radioactive contents as presented for transport.

Packaging: A shipping container without its contents.

Paleocene – Noting or pertaining to an epoch of the Tertiary period, from 65 to 55 million years ago, and characterized by a proliferation of mammals.

Particulate matter: Materials such as dust, dirt, soot, smoke, and liquid droplets that are emitted into the air by sources such as factories, power plants, cars, construction activity, fires, and natural windblown dust. Exposure to high concentrations of particulate matter can affect breathing, aggravate existing respiratory and cardiovascular disease, alter the body's defense systems against foreign materials, damage lung tissue, and cause premature death.

Peak ground acceleration: The maximum acceleration experienced by the particle on the ground during the course of the earthquake motion.

Permeability: The capability of a soil or rock to transmit a fluid.

Pedestrian inspection: The process of walking over an area with the goal of identifying whether or not cultural materials or architectural debris are observable on the ground surface. Such an inspection can either be systematic or random, depending on project goals and/or field conditions. Systematic pedestrian inspection typically involves one or more individuals walking along evenly spaced transects aligned either to cardinal directions or landform shape.

Perennial: A feature that contains water year round during a year of normal rainfall, with the aquatic bed located below the water table for most of the year. A perennial stream exhibits the typical biological, hydrological, and physical characteristics commonly associated with the continuous conveyance of water.

Personnel monitoring: The use of portable survey meters to determine the amount of radioactive contamination on individuals; or, the use of dosimetry to determine an individual's occupational radiation dose.

Person-rem: A measure of the radiation dose to a given population; the sum of the individual radiation doses received by that population.

pH: A measure of the hydrogen ion concentration in aqueous solution. Pure water has a pH of 7, acidic solutions have a pH less than 7, and alkaline solutions have a pH greater than 7.

Physiographic: Geographic regions based on geologic setting.

Pigtail operations: Refers to the activities related to the connection and disconnection of the valving and hosing associated with feed and withdrawal operations.

Plate (Tectonic): The two sub-layers of the earth's crust (lithosphere) that move, float, and sometimes fracture; the interaction of these layers causes continental drift, earthquakes, volcanoes, mountains, and oceanic trenches.

Pleistocene: Noting or pertaining to the epoch forming the earlier half of the Quaternary period, beginning about 1.75 million years ago and ending 11,500 years ago, characterized by widespread glacial ice and the advent of modern humans.

Pliocene: Noting or pertaining to an epoch of the Tertiary period, occurring from 5 to 1.75 million years ago and characterized by the increased size and numbers of mammals, by the growth of mountains, and by global climatic cooling.

Plio-Pleistocene: A generalized period of geologic time that straddles the chronostratigraphic boundary (approximately 1.8 million years ago) between the Pliocene and Pleistocene epochs. This period occurs sometime after the beginning (approximately 5 million years ago) of the Pliocene epoch (last epoch of the Tertiary period) and extends for some unspecified period of time into the more recent Pleistocene epoch (first epoch of the Quaternary period ending approximately 11.5 thousand years ago).

Plume: The elongated pattern of contaminated air or water originating at a point source, such as a smokestack or a hazardous waste disposal site.

PM₁₀: Particulate matter with a 10-micron or less aerodynamic diameter. PM₁₀ includes PM_{2.5}.

PM_{2.5}: Particulate matter with aerodynamic diameter of 2.5 µm or less. Since it is very small, PM_{2.5} is important because it can be inhaled deep into the lungs.

Point source: A source of effluents that is small enough in dimensions that it can be treated as if it were a point. The converse is a diffuse source. A point source can be either a continuous source or a source that emits effluents only in puffs or for a short time.

Pollutant: Any material entering the environment that has undesired effects.

Pollution: The addition of an undesirable agent to the environment in excess of the rate at which natural processes can degrade, assimilate, or disperse it.

Pollution prevention: The use of any process, practice, or product that reduces or eliminates the generation and release of pollutants, hazardous substances, contaminants, and wastes, including those that protect natural resources through conservation or more efficient utilization.

Population dose: The sum of the radiation doses received by the individual members of a population.

Porosity: Percentage of void space in a material.

Potable water: Water that is safe for human consumption.

Potentiometric surface: Surface to which water in an aquifer would rise by hydrostatic pressure. It is usually represented in figures as a contour map, in which each point indicates how high the water would rise in a well tapping that aquifer at that point.

Precambrian: All geologic time and its corresponding rocks before the beginning of the Paleozoic era, equal to about 90% of geologic time. The Precambrian ended 570 million years ago, during which the Earth's crust formed and life first appeared in the seas.

Prehistoric: Predating written history, in North America, also predating contact with Europeans.

Progeny: Stable or radioactive elements formed by the radioactive decay of another nuclide, which is the “parent.”

Quality Factor: A modifying factor used to calculate the dose equivalent from absorbed dose. The quality factor can vary by type and energy of the ionizing radiation.

Quaternary: Noting or pertaining to the present period of Earth’s history, forming the latter part of the Cenozoic era, originating about 2 million years ago and including the Recent and Pleistocene epochs.

Rad: The special unit for radiation absorbed dose, which is the amount of energy from any type of ionizing radiation (e.g., alpha, beta, gamma, neutrons, etc.) deposited in any medium (e.g., water, tissue, air). A dose of one rad means the absorption of 100 ergs (a small but measurable amount of energy) per gram of absorbing tissue (100 rad = 1 gray).

Radiation: Ionizing radiation; e.g., alpha particles, beta particles, gamma rays, X-rays, neutrons, protons, and other particles capable of producing ion pairs in matter. As used in this document, radiation does not include nonionizing radiation.

Radiation standards: Exposure standards, permissible concentrations, rules for safe handling, regulations for transportation, regulations for industrial control of radiation, and control of radioactive material by legislative means.

Radioactive waste: Materials from nuclear operations that are radioactive or are contaminated with radioactive materials and for which there is no practical use or for which recovery is impractical.

Radioactivity: The property or characteristic of radioactive material to undergo spontaneous transformations (“disintegrations” or “decay”) with the emission of energy in the form of radiation. It means the rate of spontaneous transformations of a radionuclide. The unit of radioactivity is the curie (or becquerel). (1 curie = 3.7×10^{10} becquerel).

Radionuclide: A nuclide that emits radiation by spontaneous transformation.

Rare: Species listed as threatened, endangered, or other special concern by the state or federal government.

Recharge: The downward vertical flow of groundwater to an aquifer. Recharge may be from seepage through the unsaturated zone (for unconfined aquifers) or downward flow from overlying layers (for confined aquifers).

Reference dose: The reference dose is an estimate of the daily exposure to the human population (including sensitive subgroups) that is likely to be without an appreciable risk of deleterious effects during a portion of the lifetime (subchronic reference dose), or during a lifetime (chronic reference dose).

Regional economic area: A geographic area consisting of an economic node and the surrounding counties that are economically related and include the places of work and residences of the labor force. The U.S. Bureau of Economic Analysis defines each regional economic area.

Region of influence (ROI): The physical area that bounds the environmental, sociological, economic, or cultural features of interest for the purpose of analysis. A site-specific geographic area that includes the counties where approximately 90 percent of the site's current employees reside.

Relief: A term used loosely for the physical shape, configuration, or general unevenness of a part of the Earth's surface, considered with reference to variations of height and slope or to irregularities of the land surface; the elevations or differences in elevation, considered collectively, of a land surface.

Rem: A common (or special) unit of dose equivalent, effective dose equivalent, or committed dose equivalent.

Remediation: Action taken to permanently remedy a release, or threatened release, of a hazardous or radioactive substance to the environment, instead of or in addition to removal.

Resource Conservation and Recovery Act: This Act was designed to provide "cradle to grave" control of hazardous chemical wastes.

Restricted area: Any area to which access is controlled for the protection of individuals from exposure to radiation and radioactive materials.

Riparian: The land adjacent to the banks or the banks of any river or stream.

Risk: The likelihood of suffering a detrimental effect as a result of exposure to a hazard. In accident analysis, the probability weighted consequence of an accident, defined as the accident frequency per year multiplied by the consequence.

Risk assessment (chemical or radiological): The qualitative and quantitative evaluation performed in an effort to define the risk posed to human health and/or the environment by the presence or potential presence and/or use of specific chemical or radiological materials.

Roentgen: A unit of exposure to ionizing radiation. It is the amount of gamma or x-rays required to produce ions resulting in a charge of 0.000258 coulombs/kilogram of air under standard conditions. Named after Wilhelm Roentgen, the German scientist who discovered x-rays in 1895.

Roentgen equivalent man (REM): The unit of radiation dose equivalent.

Runoff: The portion of rainfall that is not absorbed by soil, evaporated, or transpired by plants, but finds its way into streams directly or as overland surface flows.

Sanitary/industrial waste: Nonhazardous, nonradioactive liquid and solid waste generated by normal housekeeping activities.

Scenario: A set of conditions presumed for the purpose of estimating doses by analysis.

Sediment: Eroded soil particles that are deposited downhill or downstream by surface runoff.

Seismic: Pertaining to any earth vibration, especially an earthquake.

Seismicity: All of the earthquakes that may occur in a region, regardless of magnitude.

Sherd: A fragment of a ceramic vessel.

Shielding: Any material or obstruction that absorbs radiation and thus tends to protect personnel or materials from the effects of ionizing radiation.

Sievert (Sv): A unit of radiation dose used to express a quantity called equivalent dose. This relates the absorbed dose in human tissue to the effective biological damage of the radiation by taking into account the kind of radiation received, the total amount absorbed by the body, and the tissues involved. Not all radiation has the same biological effect, even for the same amount of absorbed dose. One sievert is equivalent to 100 rem.

Silt: A sedimentary material consisting of fine mineral particles intermediate in size between sand and clay.

Site characterization: An onsite investigation at a known or suspected contaminated waste or release site to determine the extent and type(s) of contamination.

Soil association unit: A landscape or soil grouping that has a distinctive proportional pattern of soils; it normally consists of one or more major soils and at least one minor soil, and is named for the major soil(s).

Solubility: The degree to which a compound in its pure state will dissolve; water is the solvent used for determining aqueous solubility of a compound.

Source material: Uranium or thorium ores containing 0.05 percent Uranium or Thorium regulated under the *Atomic Energy Act*. In general, this includes all materials containing radioactive isotopes in concentrations greater than natural and the by-product (tailings) from the formation of these concentrated materials

Source term: The kinds and amounts of radionuclides that may lead to an assumed release of radioactive material.

Spoil: Soil that has been excavated and moved from its original location, as in sediment removed from ditches.

Stability: A property of the atmosphere that suppresses mixing. The main parameter determining stability is the vertical temperature profile of the atmosphere.

Stability Class: A letter code indicating the degree of atmospheric stability. Stability Class A refers to the most unstable atmospheric conditions, with strong mixing, and Stability Class F refers to the most stable atmospheric conditions, with little mixing. Stability Class D is considered stable.

State Historic Preservation Officer (SHPO): The state officer charged with the identification and protection of prehistoric and historic resources in accordance with the *National Historic Preservation Act*.

Storage: Temporary placement of waste in a facility. Storage usually implies the need for continued surveillance.

Stormwater: The flow of water that results from precipitation and that occurs immediately following rainfall or as a result of snowmelt.

Strata: Layers of rock.

Stratigraphy: The study of layered sequences of rocks.

Structural fill: Soil considered suitable for placement and compaction in areas where structures will be constructed.

Subsidence: The process of sinking or settling of a land surface due to natural or artificial causes.

Surface water: A creek, stream, river, pond, lake, bay, sea, or other waterway that is directly exposed to the atmosphere.

Surficial aquifer: Water-borne unconsolidated and residual deposits occurring on or near the Earth's surface, generally unstratified and representing the most recent of geologic deposits.

Tails: In the uranium enrichment process, tails refers to gas with a reduced concentration of the uranium-235 isotope.

Tectonic activity: Movement of the earth's crust, produced by internal forces, such as uplift, subsidence, folding, faulting, and seismic activity.

Tertiary: The first period of the Cenozoic era (after the Cretaceous period of the Mesozoic era and before the Quaternary period), thought to have covered the span of time between 65 million years and 3 to 2 million years ago. The Tertiary period is divided into five epochs: the Paleocene, Eocene, Oligocene, Miocene, and Pliocene.

Threatened Species: Any species likely to become an endangered species within the foreseeable future throughout all or a significant portion of its range. Requirements for declaring a species threatened are contained in the *Endangered Species Act*.

Title V: Title V of the 1990 *Clean Air Act Amendments* requires all major sources and some minor sources of air pollution to obtain an operating permit. A title V permit grants a source permission to operate. The permit includes all air pollution requirements that apply to the source, including emission limits and monitoring, record keeping, and reporting requirements. It also requires that the source report its compliance status with respect to permit conditions to the permitting authority.

Topography: The shape of Earth's surface or the geometry of landforms in a geographic area.

Topsoil: The fertile, surface portion of a soil; usually dark colored and rich in organic material.

Total effective dose equivalent: The sum of the effective dose equivalent from radiation sources external to the body during the year plus the committed effective dose equivalent from radionuclides taken into the body. A 50-year time interval is assumed for determining committed dose.

Toxic Substances Control Act (TSCA): A federal law authorizing the U.S. Environmental Protection Agency to secure information on all new and existing chemical substances and to control any of these substances determined to cause unreasonable risk to public health or the environment. This law requires that the health and environmental effects of all new chemicals be reviewed by the EPA before such chemicals are manufactured for commercial purposes.

Transmissivity: A quantity defined in the study of groundwater hydraulics that describes the rate at which water may be transmitted through an aquifer. It has units of length²/time.

Travel corridor: Pathways that animals use to travel from one location to another to acquire resources.

Unconfined aquifer: An aquifer that is not confined by a less-permeable confining unit. An aquifer where the water table elevation represents the hydraulic potential.

Unincorporated area: An area that is not located within the jurisdiction of any local government. Such unincorporated areas are governed and taxed by county-level government.

Uplift (geologic): A structurally high area in the crust, produced by positive movements that raise or upthrust the rocks, as in a dome or arch.

Uranium: A radioactive element with the atomic number 92 and, as found in natural ores, an atomic weight of approximately 238. The two principal natural isotopes are uranium-235 (0.7 percent of natural uranium), which is fissile, and uranium-238 (99.3 percent of natural uranium), which is fissionable by fast neutrons and is fertile. Natural uranium also includes a minute amount of uranium-234.

Viewshed: The area on the ground that is visible from a specific location.

Visual Resource Management (VRM): A process devised by the Bureau of Land Management to assess the aesthetic quality of a landscape and to design proposed activities in a way that would minimize their visual impact on that landscape. The process consists of a rating of site visual quality followed by a measurement of the degree of contrast between the proposed development activities and the existing landscape.

Visual and Scenic Resources: Natural or developed landscapes that provide information for an individual to develop their perceptions of the area. The size, type, gradient, scale, and continuity of landforms, structures, land use patterns, and vegetation are all contributing factors to an area's visual character and how it is perceived.

Void volume: That part of the total volume not occupied by the solid volume. The void volume may contain either liquid or gas.

Volatile organic compound: Any compound containing carbon and hydrogen in combination with any other element that has a vapor pressure of 77.6 millimeters of mercury (1.5 pounds per square inch) absolute or greater under actual storage conditions.

Volatilization: To evaporate at normal temperatures and pressures.

Waste management: The planning, coordination, and direction of functions related to generation, handling, treatment, storage, transportation, and disposal of waste. It also includes associated pollution prevention and surveillance and maintenance activities.

Waste minimization: An action that economically avoids or reduces the generation of waste by source reduction and recycling; or reduces the toxicity of hazardous waste, improving energy usage.

Water resources: This term includes both freshwater and marine systems, wetlands, floodplains, and ground water.

Water table: The top of an unconfined aquifer, below which the aquifer is saturated.

Wetlands: Land or areas exhibiting the following characteristics: hydric soil conditions; saturated or inundated soil during some part of the year and plant species tolerant of such conditions; also, areas that are inundated or saturated by surface or groundwater at a frequency and duration sufficient to support, under normal circumstances, a prevalence of vegetation typically adapted for life in saturated soil conditions. Wetlands generally include swamps, marshes, bogs, and similar areas.

Wind Rose: A plot of wind direction and speed showing the distribution of directions that the wind blows from at a measurement site. The proportion of the time that a wind blows from any given direction is indicated by the length of the “petal” on the wind rose.

Wind Speed: The speed of air movement measured for a set height above ground level (agl) at a meteorological observing site. This height may vary depending on the location. Typically, anemometers at National Weather Service stations are placed at 32 ft 10 inches (10 m) agl; however, some are still found at 20 ft (6 m) agl.

APPENDIX B CONSULTATION DOCUMENTS

B-1: American Indian Consultation List of Addressees

Apache of Oklahoma

Henry Kostzuta, Chairman of the Board
Apache Tribe of Oklahoma
PO Box 1220
Anadarko, OK 73005-1220

Commache Nation of Oklahoma Tribe

Wallace Coffey, Tribal Chairman
584 NW Bingo Road
HC 32 Box 1720
P.O. Box 908
Lawton, Oklahoma 73507

cc: Comanche of Oklahoma

Jimmy Arterberry, NAGPRA Director
Comanche of Oklahoma
6 SW "D" Avenue
Lawton, OK 73502

Kiowa Tribe of Oklahoma

Don (Donnie) Tofpi, Tribal Chairman
Kiowa Tribe of Oklahoma
P.O. Box 369
Carnegie, Oklahoma 73015-0369

Mescalero Apache Tribe

Mark Chino, President
Mescalero Apache Tribe
P.O. Box 227
Mescalero, New Mexico 88340

Ysleta del Sur Pueblo Tribe

Frank Paiz, Governor
Ysleta del Sur Pueblo
PO Box 17579 – Ysleta Station
El Paso, TX 79917

B-2: Local Officials Consultation List of Addressees

Mayor, City of Eunice

Johnnie "Matt" White, Mayor
City of Eunice
Box 494
Eunice, New Mexico 88231

Mayor, City of Jal

Alton Dunn, Mayor
City of Jal
621 S. 4th Street
Jal, New Mexico, 88252

Mayor, City of Andrews, Texas

Robert Zap, Mayor
City of Andrews, Texas
111 Lodsdon
Andrews, TX 79714

Mayor, City of Hobbs

Gary Don Regan, Mayor
City of Hobbs
200 E Broadway
Hobbs, New Mexico 88240

Mayor of Lovington

Dixie Drummond, Mayor
City of Lovington
214 South Love
Lovington, New Mexico 88260

Mayor, City of Tatum

Betty C. Rickman (?), Mayor
City of Tatum
120 West Broadway
Tatum, New Mexico 88267

Mayor of Seminole, Texas

Wayne Mixon, Mayor
City of Seminole, Texas
302 South Main
Seminole, Texas 79360

Lea County Manager

Michael Beverly, Lea County Manager
100 N. Main
Lovington, New Mexico 88260

County Judge of Andrews County, Texas

Richard H. Dolgener, Andrews County Judge
201 N. Main, Rm 104
Andrews, Texas 79714

County Judge of Gaines, Texas

Tom N. Keyes, Gaines County Judge
101 South Main, Room 110
P.O. Box 847
Seminole, Texas 79360

B-3: State Officials Consultation List of Addressees

Bureau of Land Management

Mr. Ed Roberson, Roswell Field Office Manager
Bureau Of Land Management
2909 W. Second Roswell, NM 88201

New Mexico Department of Game & Fish

Tod Stevenson, Director and Secretary to the Commission
State of New Mexico Department of Game & Fish
1 Wildlife Way
P.O. Box 25112
Santa Fe, NM 87504

New Mexico Department of Cultural Affairs

Ms. Katherine Slick, Director
NM Historic Preservation Division
New Mexico Department of Cultural Affairs
Bataan Memorial Building
407 Galisteo Street, Suite 236
Santa Fe, NM 87501

New Mexico Environment Department

Ron Curry
Cabinet Secretary
New Mexico Environment Department
P.O. Box 5469
Santa Fe, New Mexico, 87502-5469

New Mexico Environment Department

Carlo Romera, Division Director
Environmental Health Division
New Mexico Environment Department
P.O. Box 5469
Santa Fe, New Mexico, 87502-5469

New Mexico Environment Department

Jim Norton, Division Director
Environmental Protection Division
New Mexico Environment Department
P.O. Box 5469
Santa Fe, New Mexico, 87502-5469

New Mexico Environment Department

Marcy Leavitt, Division Director
Water and Waste Management Division
New Mexico Environment Department
P.O. Box 5469
Santa Fe, New Mexico, 87502-5469

New Mexico Environment Department

Karen Gallegos, Division Director
Water and Wastewater Infrastructure Development Division
New Mexico Environment Department
P.O. Box 5469
Santa Fe, New Mexico, 87502-5469

New Mexico Energy, Minerals and Natural Resources Division

Bill Brancard, Division Director
New Mexico Energy, Minerals and Natural Resources Division
1220 South St. Francis Drive
Santa Fe, New Mexico 87505

New Mexico Office of the State Engineer

John D'Antonio, P.E.
New Mexico State Engineer/Secretary, Interstate Stream Commission
130 South Capitol Street
Concha Ortiz y Pino Building
P.O. Box 25102
Santa Fe, New Mexico 87504-5102

New Mexico State Land Office

Patrick H. Lyons, Commissioner of Public Lands
New Mexico State Land Office
310 Old Santa Fe Trail
P.O. Box 1148
Santa Fe, New Mexico 87504-1148

New Mexico Attorney General

Gary King, New Mexico Attorney General
408 Galisteo Street
Villagra Building
P.O. Drawer 1508
Santa Fe, New Mexico 87504-1508

Texas Department of State Health Services Radiation Control

Richard A Ratlif, P. E., Radiation Control Program Director
Texas Department of State Health Services
P. O. Box 149347
Austin, Texas 78714-6688

New Mexico Department of Transportation

Edward Rios, P.S., Division Manager
Office of Infrastructure Divisions
604 W. San Mateo
Santa Fe, New Mexico 87504

New Mexico Office of the Governor

Bill Richardson,
Office of the Governor
490 Old Santa Fe Trail
Room 400
Santa Fe, NM 87501

B-4: U.S. Officials Consultation List of Addressees

United States Department of the Interior U.S. Fish & Wildlife Service

Ms. Joy Nicholopoulous, Ecological Services Field Supervisor
United States Department of the Interior
U.S. Fish & Wildlife Service
New Mexico Ecological Services Field Office
2105 Osuna Road NE
Albuquerque, NM 87113-1001

United States EPA Region 6 Office of Environmental Justice and Tribal Affairs

Deborah C. Ponder, Acting Director
Region 6 Office of Environmental Justice and Tribal Affairs
1445 Ross Avenue, Suite 1200
Dallas, Texas 75202



MAYOR'S OFFICE

200 East Broadway
Hobbs, New Mexico 88240

505-397-9226 bus

Steve Laffin
President & CEO
International Isotopes, Inc.
4137 Commerce Circle
Idaho Falls, ID 83401

Re: International Isotopes, Inc.

Dear Mr. Laffin:

On behalf of the City of Hobbs, I would like to express approval in support to the proposal to locate the Uranium Enrichment and Fluorine Extraction Facility in Lea County. The City of Hobbs supports the Economic Development Corporation of Lea County's proposal to help bring diversity to our economy and to create jobs in the area.

The City of Hobbs will offer any assistance possible to the EDC of Lea County or the INIS project team in this endeavor.

Sincerely,

A handwritten signature in black ink that reads "Gary Don Reagan". The signature is written in a cursive style.

Gary Don Reagan
Mayor

Lea County Board of Commissioners
100 North Main, Suite 4
Livingston, New Mexico 88260



Phone (575) 396-8602
Fax (575) 396-2093

Steve Laffin
President & CEO
International Isotopes, Inc.
4137 Commerce Circle
Idaho Falls, ID 83401

Dear Mr. Laffin:

From the information given to me, it gives me great pleasure to inform you of my strong support regarding the pending proposal to site the International Isotopes, Inc. Uranium Enrichment and Fluorine Extraction Facility in Lea County. As a Commissioner from Lea County, I also want to extend to you, and the developers of this project, the services of my office and offer any assistance I can possibly provide through the Lea County Commission.

I sincerely believe that this project fits well into the social/economic environment of Lea County and cannot foresee any problem with obtaining and maintaining community support. I also feel that this will compliment the established oil and gas industry, especially within the area of professional development.

The Commission has been most interested in bringing diversity to our economy by working with strong companies like INIS. The Commissioners lead in securing political support for our new \$45 million correctional facility, secured a tax abatement package for LES, and gained approval for a property tax exemption when Texaco planned a multimillion dollar expansion. These are only the latest examples of the Commission's commitment to partnering with private business.

The possibility of creating new jobs and opportunities for the cities of Lea County by bringing the Uranium Enrichment and Fluorine Extraction Facility will carry a high priority with the Lea County Board of Commissioners. Whether INIS needs industrial revenue bonds or property tax exemptions please give us an opportunity to help.

Sincerely,

A handwritten signature in blue ink, appearing to read "Gary Schubert", is written over a circular stamp or seal.

Gary Schubert
Lea County Commissioner, Chairman

STEVAN PEARCE
2ND DISTRICT, NEW MEXICO
ASSISTANT REPUBLICAN WHIP
1817 LONGWORTH HOUSE OFFICE BUILDING
WASHINGTON, DC 20515
(202) 225-7388
(202) 225-8855 FAX
www.house.gov/pearce



Congress of the United States
House of Representatives
Washington, DC 20515-3102

COMMITTEES:
FINANCIAL SERVICES
SUBCOMMITTEES:
DEPUTY RANKING MEMBER,
TEXTING AND COMMUNITY OPPORTUNITY;
FINANCIAL INSTITUTIONS AND CONSUMER CREDIT
NATURAL RESOURCES
SUBCOMMITTEES:
STANDING MEMBER,
ENERGY AND MINERAL RESOURCES;
NATIONAL PARKS, FORESTS, AND PUBLIC LANDS

August 29, 2008

Steve Laffin
President & CEO
International Isotopes, Inc.
4137 Commerce Circle
Idaho Falls, ID 83401

Dear Mr. Laffin:

I write this letter to indicate my support regarding the International Isotopes, Inc. proposal to build a Uranium Processing and Fluorine Extraction Facility in Lea County, New Mexico. This high technology facility would be an asset to Lea County. A project of this nature truly presents an exciting future for the area, and I believe that community support will be overwhelmingly strong. Community support plays a strong role in achieving the goals of a successful project. Projects such as Waste Isolation Pilot Plant in Carlsbad and National Enrichment Facility (LES) in Eunice are both projects made possible with strong community support.

My office would be more than happy to provide the Economic Development Corporation of Lea County and the developers of this project with any assistance required to insure all permits, regulatory issues and policies are put in place and followed to achieve completion according to desired timelines. We look forward to working with you in this endeavor.

Sincerely,

STEVAN PEARCE
Member of Congress

SP/ms

111 SCHOOL OF MESAS ROAD
SOFEROS, NM 87801
(505) 838-7010
Fax (505) 838-7023

400 NORTH TULSA
SUITE E
17th CARLSBAD, NM 88201
(505) 822-2218
Fax (505) 822-3888

DISTRICT OFFICE:

1717 WEST 2ND STREET
SUITE 100
HOBBS, NM 88201
(505) 822-6955
Fax (505) 825-8608

800 EAST BRIDGEMAN
HOBBS, NM 88240
(505) 392-8325
Fax (505) 433-8325



New Mexico State Senate
State Capitol
Santa Fe

COMMITTEE
MEMBER
Finance

SENATOR CARROLL H. LEAVELL
R Eddy St. Lea 41

P.O. Drawer D
Lea, NM 88252

Business: (505) 393-2550
Cell: (505) 390-5705
Fax: (505) 395-2294
E-Mail: leavell@leacon.net

September 3, 2008

Steve Laffin
President & CEO
International Isotopes, Inc.
4137 Commerce Circle
Idaho Falls, ID 83401

Dear Mr. Laffin:

I am very pleased to learn that International Isotopes, Inc. is considering Lea County for a Uranium Enrichment and Fluorine Extraction Facility. The site under consideration should serve you well.

International Isotopes, Inc. will find New Mexico and Lea County "business friendly." Many of the training programs developed to satisfy the work force needs of WIPP and the National Enrichment Facility would be available to INIS to ensure a continuous skilled labor pool. In addition, our property tax rate is one of the most favorable in the nation.

Please be aware of the opportunity to finance with Industrial Revenue Bonds and the advantage therewith that few other states offer. Rest assured of my support on both a state and local level.

Sincerely

Carroll H. Leavell



New Mexico State Senate
State Capitol
Santa Fe

SENATOR GAY G. KERNAN
R-Curr. Lea, Roosevelt
Claves & Pádo-42

928 W. Mesa Verde
Albuquerque, NM 88240

Home: (505) 397-2530
Cell: (505) 370-1336
Fax: (505) 392-1431

E-Mail: ggkern@legis.state.nm.us

COMMITTEES:

MEMBER
Education
Public Affairs

INTERIM

MEMBER
Legislative Education
Study Committee
Radioactive & Hazardous
Materials Committee

ADVISORY MEMBER:

Corrections & Justice
Public School Funding Formula
Task Force

Steve Laffin
President & CEO
International Isotopes, Inc.
4137 Commerce Circle
Idaho Falls, ID 83401

Dear Mr. Laffin:

The State of New Mexico is aware of the possible development of the Uranium Enrichment and Fluorine Extraction Facility in Lea County. We are confident that New Mexico is a viable option for this INIS facility.

We believe that the business derived from its development would be complimentary to the economic future of the people of New Mexico. This project offers an opportunity to utilize INIS's vast technological assets to stimulate job and personal income growth for Southeastern New Mexicans.

The following proposal gives INIS comprehensive documentation pertaining to the critical elements necessary to make the decision of developing the INIS facility in Lea County, New Mexico. The prudent integration of site characteristics, associated infrastructure, demographics, and financial incentives will allow INIS a tremendous opportunity for a cutting-edge facility in our state.

We look forward to your positive evaluation to the proposal, receiving additional information about this exciting project, and to working towards the mutually beneficial goal of a well paid and highly productive work force in New Mexico.

Sincerely,

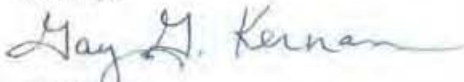
Gay Kernan



MAYOR'S OFFICE

200 East Broadway
Hobbs, New Mexico 88240

505-397-9226 bus

Steve Laflin
President & CEO
International Isotopes, Inc.
4137 Commerce Circle
Idaho Falls, ID 83401

Re: International Isotopes, Inc.

Dear Mr. Laflin:

On behalf of the City of Hobbs, I would like to express approval in support to the proposal to locate the Uranium Enrichment and Fluorine Extraction Facility in Lea County. The City of Hobbs supports the Economic Development Corporation of Lea County's proposal to help bring diversity to our economy and to create jobs in the area.

The City of Hobbs will offer any assistance possible to the EDC of Lea County or the INIS project team in this endeavor.

Sincerely,

A handwritten signature in cursive script that reads "Gary Don Reagan".

Gary Don Reagan
Mayor

Lea County Board of Commissioners
100 North Main, Suite 4
Lovington, New Mexico 88260



Phone (575) 396-8602
Fax (575) 396-2093

Steve Laffin
President & CEO
International Isotopes, Inc.
4137 Commerce Circle
Idaho Falls, ID 83401

Dear Mr. Laffin:

From the information given to me, it gives me great pleasure to inform you of my strong support regarding the pending proposal to site the International Isotopes, Inc. Uranium Enrichment and Fluorine Extraction Facility in Lea County. As a Commissioner from Lea County, I also want to extend to you, and the developers of this project, the services of my office and offer any assistance I can possibly provide through the Lea County Commission.

I sincerely believe that this project fits well into the social/economic environment of Lea County and cannot foresee any problem with obtaining and maintaining community support. I also feel that this will compliment the established oil and gas industry, especially within the area of professional development.

The Commission has been most interested in bringing diversity to our economy by working with strong companies like INIS. The Commissioners lead in securing political support for our new \$45 million correctional facility, secured a tax abatement package for LES, and gained approval for a property tax exemption when Texaco planned a multimillion dollar expansion. These are only the latest examples of the Commission's commitment to partnering with private business.

The possibility of creating new jobs and opportunities for the cities of Lea County by bringing the Uranium Enrichment and Fluorine Extraction Facility will carry a high priority with the Lea County Board of Commissioners. Whether INIS needs industrial revenue bonds or property tax exemptions please give us an opportunity to help.

Sincerely,

A handwritten signature in black ink, appearing to read "Gary Schubert", written over a circular stamp.

Gary Schubert
Lea County Commissioner, Chairman

STEVAN PEARCE
2ND DISTRICT, NEW MEXICO
—
ASSISTANT REPUBLICAN WHIP
—
1407 LONGWORTH HOUSE OFFICE BUILDING
WASHINGTON, DC 20515
(202) 225-2365
(202) 225-9689 FAX
www.house.gov/pearce



Congress of the United States
House of Representatives
Washington, DC 20515-3102

COMMITTEES:
FINANCIAL SERVICES
SUBCOMMITTEES:
DEPUTY RANKING MEMBER,
HOUSING AND COMMUNITY OPPORTUNITY
FINANCIAL INSTITUTIONS AND CONSUMER CREDIT
NATURAL RESOURCES
SUBCOMMITTEES:
RANKING MEMBER,
ENERGY AND MINERAL RESOURCES
NATIONAL PARKS, FORESTS, AND PUBLIC LANDS

August 29, 2008

Steve Laffin
President & CEO
International Isotopes, Inc.
4137 Commerce Circle
Idaho Falls, ID 83401

Dear Mr. Laffin:

I write this letter to indicate my support regarding the International Isotopes, Inc. proposal to build a Uranium Processing and Fluorine Extraction Facility in Lea County, New Mexico. This high technology facility would be an asset to Lea County. A project of this nature truly presents an exciting future for the area, and I believe that community support will be overwhelmingly strong. Community support plays a strong role in achieving the goals of a successful project. Projects such as Waste Isolation Pilot Plant in Carlsbad and National Enrichment Facility (LES) in Eunice are both projects made possible with strong community support.

My office would be more than happy to provide the Economic Development Corporation of Lea County and the developers of this project with any assistance required to insure all permits, regulatory issues and policies are put in place and followed to achieve completion according to desired timelines. We look forward to working with you in this endeavor.

Sincerely,

STEVAN PEARCE
Member of Congress

SP/ns

111 SCHOOL OF MINES ROAD
SOCORRO, NM 87801
(505) 838-7516
FAX (505) 838-7623

400 NORTH TULSA
SUITE E
LAS CRUCES, NM 88011
(505) 522-2219
FAX (505) 522-3998

DISTRICT OFFICES

1717 WEST 2ND STREET
SUITE 100
ROSWELL, NM 88201
(505) 622-0916
FAX (505) 625-9608

200 EAST BROADWAY
MOSES, NM 88240
(505) 392-8325
FAX (505) 433-8325



New Mexico State Senate

State Capitol
Santa Fe

COMMITTEES

MEMBER
Finance

SENATOR CARROLL H. LEAVELL

R-Eddy & Lea-41

P.O. Drawer D
Jal. NM 88252

Business: (505) 393-2550
Cell: (505) 390-5705
Fax: (505) 395-2284
E-Mail: leavel@leaco.net

September 3, 2008

Steve Laffin
President & CEO
International Isotopes, Inc.
4137 Commerce Circle
Idaho Falls, ID 83401

Dear Mr. Laffin:

I am very pleased to learn that International Isotopes, Inc. is considering Lea County for a Uranium-Enrichment and Fluorine Extraction Facility. The site under consideration should serve you well.

International Isotopes, Inc. will find New Mexico and Lea County "business friendly." Many of the training programs developed to satisfy the work force needs of WIPP and the National Enrichment Facility would be available to INIS to ensure a continuous skilled labor pool. In addition, our property tax rate is one of the most favorable in the nation.

Please be aware of the opportunity to finance with Industrial Revenue Bonds and the advantage therewith that few other states offer. Rest assured of my support on both a state and local level.

Sincerely

A handwritten signature in cursive script, appearing to read "Carroll H. Leavell".

Carroll H. Leavell



New Mexico State Senate

State Capitol
Santa Fe

SENATOR GAY G. KERNAN

R-Clary, Lea, Roosevelt,
Chaves & Eddy-42

928 W. Mesa Verde
Hobbs, NM 88240

Home: (505) 397-2536
Cell: (505) 370-1335
Fax: (505) 392-1431

E-Mail: gkern@vakornet.com

COMMITTEES:

MEMBER
· Education
· Public Affairs

INTERIM

MEMBER
· Legislative Education
Study Committee
· Radioactive & Hazardous
Materials Committee

ADVISORY MEMBER:

· Courts, Corrections & Justice
· Public School Funding Formula
Task Force

Steve Laffin
President & CEO
International Isotopes, Inc.
4137 Commerce Circle
Idaho Falls, ID 83401

Dear Mr. Laffin:

The State of New Mexico is aware of the possible development of the Uranium Enrichment and Fluorine Extraction Facility in Lea County. We are confident that New Mexico is a viable option for this INIS facility.

We believe that the business derived from its development would be complimentary to the economic future of the people of New Mexico. This project offers an opportunity to utilize INIS's vast technological assets to stimulate job and personal income growth for Southeastern New Mexicans.

The following proposal gives INIS comprehensive documentation pertaining to the critical elements necessary to make the decision of developing the INIS facility in Lea County, New Mexico. The prudent integration of site characteristics, associated infrastructure, demographics, and financial incentives will allow INIS a tremendous opportunity for a cutting-edge facility in our state.

We look forward to your positive evaluation to the proposal, receiving additional information about this exciting project, and to working towards the mutually beneficial goal of a well paid and highly productive work force in New Mexico.

Sincerely,

Gay Kernan

October 20, 2009

Henry Kostzuta, Chairman of Board
Apache Tribe of Oklahoma
P O Box 1220
Anadarko, OK 73005-1220

Dear Mr. Kostzuta,

International Isotopes, Inc (INIS) is proposing to construct an integrated Fluorine Extraction Process and Depleted Uranium Deconversion Plant (FEP/DUP) 14 miles west of Hobbs, New Mexico. The proposed facility will be constructed within Sections 26 and 27 of Township 18S, Range 37E. The INIS project will involve the construction of multiple buildings and an access road on the 600-acre site. Approximately 30 acres will be directly impacted by construction of the facility.

INIS is preparing an Environmental Report (ER) for this project. The ER will be submitted to the Nuclear Regulatory Commission (NRC) before the end of this year for their use in preparing an Environmental Impact Statement (EIS). We are notifying you about the project; and NRC will be scheduling, announcing, and conducting a public hearing on this project in the near future. We are asking for comments concerning the proposed facilities as they relate to archeological, cultural and historical sites important to Native American groups. Based on an initial environmental analysis, this project is not expected to result in significant negative effects on the local environment.

To facilitate your review, a site plot of the proposed FEP/DUP facilities is enclosed. Your comments will be included in the ER that will be submitted to the Nuclear Regulatory Commission (NRC) for review.

We would appreciate receiving your comments within 30 days. Should you have any questions or need additional information, please contact me at (208) 524-5300.

Sincerely,

Steve Laflin, President and CEO
International Isotopes, Inc.

Enclosure: Proposed INIS Integrated De-conversion/Fluorine Extraction Process Facility

STL-2009-10

October 20, 2009

Wallace Coffey, Tribal Chairman
Comanche Nation of Oklahoma Tribe
584 NW Bingo Road
HC 32 Box 1720
P.O. Box 908
Lawton, Oklahoma 73507

Dear Mr. Coffey,

International Isotopes, Inc (INIS) is proposing to construct an integrated Fluorine Extraction Process and Depleted Uranium Deconversion Plant (FEP/DUP) 14 miles west of Hobbs, New Mexico. The proposed facility will be constructed within Sections 26 and 27 of Township 18S, Range 37E. The INIS project will involve the construction of multiple buildings and an access road on the 600-acre site. Approximately 30 acres will be directly impacted by construction of the facility.

INIS is preparing an Environmental Report (ER) for this project. The ER will be submitted to the Nuclear Regulatory Commission (NRC) before the end of this year for their use in preparing an Environmental Impact Statement (EIS). We are notifying you about the project; and NRC will be scheduling, announcing, and conducting a public hearing on this project in the near future. We are asking for comments concerning the proposed facilities as they relate to archeological, cultural and historical sites important to Native American groups. Based on an initial environmental analysis, this project is not expected to result in significant negative effects on the local environment.

To facilitate your review, a site plot of the proposed FEP/DUP facilities is enclosed. Your comments will be included in the ER that will be submitted to the Nuclear Regulatory Commission (NRC) for review.

We would appreciate receiving your comments within 30 days. Should you have any questions or need additional information, please contact me at (208) 524-5300.

Sincerely,

Steve Laflin, President and CEO
International Isotopes, Inc.

Enclosure: Proposed INIS Integrated De-conversion/Fluorine Extraction Process Facility

cc: Jimmy Arterberry, NAGPRA Director

STL-2009-11

October 20, 2009

Don (Donnie) Tofpi, Tribal Chairman
Kiowa Tribe of Oklahoma
P.O. Box 369
Carnegie, Oklahoma 73015-0369

Dear Mr. Tofpi,

International Isotopes, Inc (INIS) is proposing to construct an integrated Fluorine Extraction Process and Depleted Uranium Deconversion Plant (FEP/DUP) 14 miles west of Hobbs, New Mexico. The proposed facility will be constructed within Sections 26 and 27 of Township 18S, Range 37E. The INIS project will involve the construction of multiple buildings and an access road on the 600-acre site. Approximately 30 acres will be directly impacted by construction of the facility.

INIS is preparing an Environmental Report (ER) for this project. The ER will be submitted to the Nuclear Regulatory Commission (NRC) before the end of this year for their use in preparing an Environmental Impact Statement (EIS). We are notifying you about the project; and NRC will be scheduling, announcing, and conducting a public hearing on this project in the near future. We are asking for comments concerning the proposed facilities as they relate to archeological, cultural and historical sites important to Native American groups. Based on an initial environmental analysis, this project is not expected to result in significant negative effects on the local environment.

To facilitate your review, a site plot of the proposed FEP/DUP facilities is enclosed. Your comments will be included in the ER that will be submitted to the Nuclear Regulatory Commission (NRC) for review.

We would appreciate receiving your comments within 30 days. Should you have any questions or need additional information, please contact me at (208) 524-5300.

Sincerely,

Steve Laffin, President and CEO
International Isotopes, Inc

Enclosure: Proposed INIS Integrated De-conversion/Fluorine Extraction Process Facility

STL-2009-12

October 20, 2009

Mark Chino, President
Mescalero Apache Tribe
P.O. Box 227
Mescalero, New Mexico 88340

Dear Mr. Chino,

International Isotopes, Inc (INIS) is proposing to construct an integrated Fluorine Extraction Process and Depleted Uranium Deconversion Plant (FEP/DUP) 14 miles west of Hobbs, New Mexico. The proposed facility will be constructed within Sections 26 and 27 of Township 18S, Range 37E. The INIS project will involve the construction of multiple buildings and an access road on the 600-acre site. Approximately 30 acres will be directly impacted by construction of the facility.

INIS is preparing an Environmental Report (ER) for this project. The ER will be submitted to the Nuclear Regulatory Commission (NRC) before the end of this year for their use in preparing an Environmental Impact Statement (EIS). We are notifying you about the project; and NRC will be scheduling, announcing, and conducting a public hearing on this project in the near future. We are asking for comments concerning the proposed facilities as they relate to archeological, cultural and historical sites important to Native American groups. Based on an initial environmental analysis, this project is not expected to result in significant negative effects on the local environment.

To facilitate your review, a site plot of the proposed FEP/DUP facilities is enclosed. Your comments will be included in the ER that will be submitted to the Nuclear Regulatory Commission (NRC) for review.

We would appreciate receiving your comments within 30 days. Should you have any questions or need additional information, please contact me at (208) 524-5300.

Sincerely,

Steve Laflin, President and CEO
International Isotopes, Inc.

Enclosure: Proposed INIS Integrated De-conversion/Fluorine Extraction Process Facility

STL-2009-13

October 20, 2009

Frank Paiz, Governor
Ysleta del Sur Pueblo Tribe
PO Box 17579 – Ysleta Station
El Paso, TX 79917

Dear Mr. Paiz,

International Isotopes, Inc (INIS) is proposing to construct an integrated Fluorine Extraction Process and Depleted Uranium Deconversion Plant (FEP/DUP) 14 miles west of Hobbs, New Mexico. The proposed facility will be constructed within Sections 26 and 27 of Township 18S, Range 37E. The INIS project will involve the construction of multiple buildings and an access road on the 600-acre site. Approximately 30 acres will be directly impacted by construction of the facility.

INIS is preparing an Environmental Report (ER) for this project. The ER will be submitted to the Nuclear Regulatory Commission (NRC) before the end of this year for their use in preparing an Environmental Impact Statement (EIS). We are notifying you about the project; and NRC will be scheduling, announcing, and conducting a public hearing on this project in the near future. We are asking for comments concerning the proposed facilities as they relate to archeological, cultural and historical sites important to Native American groups. Based on an initial environmental analysis, this project is not expected to result in significant negative effects on the local environment.

To facilitate your review, a site plot of the proposed FEP/DUP facilities is enclosed. Your comments will be included in the ER that will be submitted to the Nuclear Regulatory Commission (NRC) for review.

We would appreciate receiving your comments within 30 days. Should you have any questions or need additional information, please contact me at (208) 524-5300.

Sincerely,

Steve Laflin, President and CEO
International Isotopes, Inc.

Enclosure: Proposed INIS Integrated De-conversion/Fluorine Extraction Process Facility

STL-2009-14

October 20, 2009

Johnnie "Matt" White, Mayor
City of Eunice
Box 494
Eunice, New Mexico 88231

Dear Mayor White,

International Isotopes, Inc (INIS) is proposing to construct an integrated Fluorine Extraction Process and Depleted Uranium Deconversion Plant (FEP/DUP) 14 miles west of Hobbs, New Mexico. The proposed facility will be constructed within Sections 26 and 27 of Township 18S, Range 37E. The INIS project will involve the construction of multiple buildings and an access road on a 600-acre site. Approximately 30 acres will be directly impacted by construction of the facility.

INIS is preparing an Environmental Report (ER) for this project. The ER will be submitted to the Nuclear Regulatory Commission (NRC) before the end of this year for their use in preparing an Environmental Impact Statement (EIS). We are notifying you about the project; and NRC will be scheduling, announcing, and conducting a public hearing on this project in the near future. We are asking for comments concerning the proposed facilities as they relate to socioeconomic impact issues or other issues important to you. Based on an initial environmental analysis, this project is not expected to result in significant negative effects on the local environment.

To facilitate your review, a site plot of the proposed FEP/DUP facilities is also enclosed. Your comments will be included in the ER that will be submitted to the Nuclear Regulatory Commission (NRC) for review.

We would appreciate receiving your comments within 30 days. Should you have any questions or need additional information, please contact me at (208) 524-5300.

Sincerely,

Steve Laflin, President and CEO
International Isotopes, Inc.

Enclosure: Proposed INIS Fluorine Extraction Process and Depleted Uranium De-conversion Plant

STL-2009-16

October 20, 2009

Alton Dunn, Mayor
City of Jal
621 S. 4th Street
Jal, New Mexico, 88252

Dear Mayor Dunn,

International Isotopes, Inc (INIS) is proposing to construct an integrated Fluorine Extraction Process and Depleted Uranium Deconversion Plant (FEP/DUP) 14 miles west of Hobbs, New Mexico. The proposed facility will be constructed within Sections 26 and 27 of Township 18S, Range 37E. The INIS project will involve the construction of multiple buildings and an access road on a 600-acre site. Approximately 30 acres will be directly impacted by construction of the facility.

INIS is preparing an Environmental Report (ER) for this project. The ER will be submitted to the Nuclear Regulatory Commission (NRC) before the end of this year for their use in preparing an Environmental Impact Statement (EIS). We are notifying you about the project; and NRC will be scheduling, announcing, and conducting a public hearing on this project in the near future. We are asking for comments concerning the proposed facilities as they relate to socioeconomic impact issues or other issues important to you. Based on an initial environmental analysis, this project is not expected to result in significant negative effects on the local environment.

To facilitate your review, a site plot of the proposed FEP/DUP facilities is also enclosed. Your comments will be included in the ER that will be submitted to the Nuclear Regulatory Commission (NRC) for review.

We would appreciate receiving your comments within 30 days. Should you have any questions or need additional information, please contact me at (208) 524-5300.

Sincerely,

Steve Laflin, President and CEO
International Isotopes, Inc.

Enclosure: Proposed INIS Fluorine Extraction Process and Depleted Uranium De-conversion Plant

STL-2009-17

October 20, 2009

Robert Zap, Mayor
City of Andrews, Texas
111 Lodsdon
Andrews, TX 79714

Dear Mayor Zap,

International Isotopes, Inc (INIS) is proposing to construct an integrated Fluorine Extraction Process and Depleted Uranium Deconversion Plant (FEP/DUP) 14 miles west of Hobbs, New Mexico. The proposed facility will be constructed within Sections 26 and 27 of Township 18S, Range 37E. The INIS project will involve the construction of multiple buildings and an access road on a 600-acre site. Approximately 30 acres will be directly impacted by construction of the facility.

INIS is preparing an Environmental Report (ER) for this project. The ER will be submitted to the Nuclear Regulatory Commission (NRC) before the end of this year for their use in preparing an Environmental Impact Statement (EIS). We are notifying you about the project; and NRC will be scheduling, announcing, and conducting a public hearing on this project in the near future. We are asking for comments concerning the proposed facilities as they relate to socioeconomic impact issues or other issues important to you. Based on an initial environmental analysis, this project is not expected to result in significant negative effects on the local environment.

To facilitate your review, a site plot of the proposed FEP/DUP facilities is also enclosed. Your comments will be included in the ER that will be submitted to the Nuclear Regulatory Commission (NRC) for review.

We would appreciate receiving your comments within 30 days. Should you have any questions or need additional information, please contact me at (208) 524-5300.

Sincerely,

Steve Laflin, President and CEO
International Isotopes, Inc.

Enclosure: Proposed INIS Fluorine Extraction Process and Depleted Uranium De-conversion Plant

cc: Glen E. Hackler, City Manager

STL-2009-18

October 20, 2009

Gary Don Regan, Mayor
City of Hobbs
200 E Broadway
Hobbs, New Mexico 88240

Dear Mayor Regan,

International Isotopes, Inc (INIS) is proposing to construct an integrated Fluorine Extraction Process and Depleted Uranium Deconversion Plant (FEP/DUP) 14 miles west of Hobbs, New Mexico. The proposed facility will be constructed within Sections 26 and 27 of Township 18S, Range 37E. The INIS project will involve the construction of multiple buildings and an access road on a 600-acre site. Approximately 30 acres will be directly impacted by construction of the facility.

INIS is preparing an Environmental Report (ER) for this project. The ER will be submitted to the Nuclear Regulatory Commission (NRC) before the end of this year for their use in preparing an Environmental Impact Statement (EIS). We are notifying you about the project; and NRC will be scheduling, announcing, and conducting a public hearing on this project in the near future. We are asking for comments concerning the proposed facilities as they relate to socioeconomic impact issues or other issues important to you. Based on an initial environmental analysis, this project is not expected to result in significant negative effects on the local environment.

To facilitate your review, a site plot of the proposed FEP/DUP facilities is also enclosed. Your comments will be included in the ER that will be submitted to the Nuclear Regulatory Commission (NRC) for review.

We would appreciate receiving your comments within 30 days. Should you have any questions or need additional information, please contact me at (208) 524-5300.

Sincerely,

Steve Laffin, President and CEO
International Isotopes, Inc.

Enclosure: Proposed INIS Fluorine Extraction Process and Depleted Uranium De-conversion Plant

cc: Eric Honeyfield, City Manager

STL-2009-19

October 20, 2009

Dixie Drummond, Mayor
City of Lovington
214 South Love
Lovington, New Mexico 88260

Dear Mayor Drummond,

International Isotopes, Inc (INIS) is proposing to construct an integrated Fluorine Extraction Process and Depleted Uranium Deconversion Plant (FEP/DUP) 14 miles west of Hobbs, New Mexico. The proposed facility will be constructed within Sections 26 and 27 of Township 18S, Range 37E. The INIS project will involve the construction of multiple buildings and an access road on a 600-acre site. Approximately 30 acres will be directly impacted by construction of the facility.

INIS is preparing an Environmental Report (ER) for this project. The ER will be submitted to the Nuclear Regulatory Commission (NRC) before the end of this year for their use in preparing an Environmental Impact Statement (EIS). We are notifying you about the project; and NRC will be scheduling, announcing, and conducting a public hearing on this project in the near future. We are asking for comments concerning the proposed facilities as they relate to socioeconomic impact issues or other issues important to you. Based on an initial environmental analysis, this project is not expected to result in significant negative effects on the local environment.

To facilitate your review, a site plot of the proposed FEP/DUP facilities is also enclosed. Your comments will be included in the ER that will be submitted to the Nuclear Regulatory Commission (NRC) for review.

We would appreciate receiving your comments within 30 days. Should you have any questions or need additional information, please contact me at (208) 524-5300.

Sincerely,

Steve Laflin, President and CEO
International Isotopes, Inc.

Enclosure: Proposed INIS Fluorine Extraction Process and Depleted Uranium De-conversion Plant

cc: Pat Wise, City Manager

STL-2009-20

October 20, 2009

Betty C. Rickman, Mayor
City of Tatum
120 West Broadway
Tatum, New Mexico 88267

Dear Mayor Rickman,

International Isotopes, Inc (INIS) is proposing to construct an integrated Fluorine Extraction Process and Depleted Uranium Deconversion Plant (FEP/DUP) 14 miles west of Hobbs, New Mexico. The proposed facility will be constructed within Sections 26 and 27 of Township 18S, Range 37E. The INIS project will involve the construction of multiple buildings and an access road on a 600-acre site. Approximately 30 acres will be directly impacted by construction of the facility.

INIS is preparing an Environmental Report (ER) for this project. The ER will be submitted to the Nuclear Regulatory Commission (NRC) before the end of this year for their use in preparing an Environmental Impact Statement (EIS). We are notifying you about the project; and NRC will be scheduling, announcing, and conducting a public hearing on this project in the near future. We are asking for comments concerning the proposed facilities as they relate to socioeconomic impact issues or other issues important to you. Based on an initial environmental analysis, this project is not expected to result in significant negative effects on the local environment.

To facilitate your review, a site plot of the proposed FEP/DUP facilities is also enclosed. Your comments will be included in the ER that will be submitted to the Nuclear Regulatory Commission (NRC) for review.

We would appreciate receiving your comments within 30 days. Should you have any questions or need additional information, please contact me at (208) 524-5300.

Sincerely,

Steve Laflin, President and CEO
International Isotopes, Inc.

Enclosure: Proposed INIS Fluorine Extraction Process and Depleted Uranium De-conversion Plant

STL-2009-21

October 20 2009

Jim Norton, Division Director
Environmental Protection Division
New Mexico Environment Department
P.O. Box 5469
Santa Fe, New Mexico, 87502-5469

Dear Mr. Norton,

International Isotopes, Inc (INIS) is proposing to construct an integrated Fluorine Extraction Process and Depleted Uranium Deconversion Plant (FEP/DUP) 14 miles west of Hobbs, New Mexico. The proposed facility will be constructed within Sections 26 and 27 of Township 18S, Range 37E. The INIS project will involve the construction of multiple buildings and an access road on the 600-acre site. Approximately 30 acres will be directly impacted by construction of the facility.

INIS is preparing an Environmental Report (ER) for this project. The ER will be submitted to the Nuclear Regulatory Commission (NRC) before the end of this year for their use in preparing an Environmental Impact Statement (EIS). We are notifying you about the project; and NRC will be scheduling, announcing, and conducting a public hearing on this project in the near future. We are asking for comments and information concerning the proposed facilities as they relate to threatened and endangered species, critical habitats, other wildlife, wetlands, and any other natural resource or waste management concerns. Based on an initial environmental analysis, this project is not expected to result in significant negative effects on the local environment.

To facilitate your review, a site plot of the proposed FEP/DUP facilities is also enclosed. Your comments will be included in the ER that will be submitted to the Nuclear Regulatory Commission (NRC) for review.

We would appreciate receiving your comments within 30 days. Should you have any questions or need additional information, please contact me at (208) 524-5300.

Sincerely,

Steve Laflin, President and CEO
International Isotopes, Inc.

Enclosure: Proposed INIS Fluorine Extraction Process and Depleted Uranium De-conversion Plant

cc: Auralie Ashley-Marx, Solid Waste Bureau
Mary Uhi, Air Quality Bureau
Butch Tongate, Occupational Health and Safety

STL-2009-31

October 20 2009

Marcy Leavitt, Division Director
Water and Waste Management Division
New Mexico Environment Department
P.O. Box 5469
Santa Fe, New Mexico, 87502-5469

Dear Ms. Leavitt,

International Isotopes, Inc (INIS) is proposing to construct an integrated Fluorine Extraction Process and Depleted Uranium Deconversion Plant (FEP/DUP) 14 miles west of Hobbs, New Mexico. The proposed facility will be constructed within Sections 26 and 27 of Township 18S, Range 37E. The INIS project will involve the construction of multiple buildings and an access road on the 600-acre site. Approximately 30 acres will be directly impacted by construction of the facility.

INIS is preparing an Environmental Report (ER) for this project. The ER will be submitted to the Nuclear Regulatory Commission (NRC) before the end of this year for their use in preparing an Environmental Impact Statement (EIS). We are notifying you about the project; and NRC will be scheduling, announcing, and conducting a public hearing on this project in the near future. We are asking for comments and information concerning the proposed facilities as they relate to threatened and endangered species, critical habitats, other wildlife, wetlands, and any other natural resource or waste management concerns. Based on an initial environmental analysis, this project is not expected to result in significant negative effects on the local environment.

To facilitate your review, a site plot of the proposed FEP/DUP facilities is also enclosed. Your comments will be included in the ER that will be submitted to the Nuclear Regulatory Commission (NRC) for review.

We would appreciate receiving your comments within 30 days. Should you have any questions or need additional information, please contact me at (208) 524-5300.

Sincerely,

Steve Laffin, President and CEO
International Isotopes, Inc.

Enclosure: Proposed INIS Fluorine Extraction Process and Depleted Uranium De-conversion Plant

cc: James Bearzi, Hazardous Waste Bureau
Bill Olson, Groundwater Quality Bureau
Vacant, Surface Water Quality Bureau

STL-2009-32

October 20 2009

Karen Gallegos, Division Director
Water and Wastewater Infrastructure Development Division
New Mexico Environment Department
P.O. Box 5469
Santa Fe, New Mexico, 87502-5469

Dear Ms. Gallegos,

International Isotopes, Inc (INIS) is proposing to construct an integrated Fluorine Extraction Process and Depleted Uranium Deconversion Plant (FEP/DUP) 14 miles west of Hobbs, New Mexico. The proposed facility will be constructed within Sections 26 and 27 of Township 18S, Range 37E. The INIS project will involve the construction of multiple buildings and an access road on the 600-acre site. Approximately 30 acres will be directly impacted by construction of the facility.

INIS is preparing an Environmental Report (ER) for this project. The ER will be submitted to the Nuclear Regulatory Commission (NRC) before the end of this year for their use in preparing an Environmental Impact Statement (EIS). We are notifying you about the project; and NRC will be scheduling, announcing, and conducting a public hearing on this project in the near future. We are asking for comments and information concerning the proposed facilities as they relate to threatened and endangered species, critical habitats, other wildlife, wetlands, and any other natural resource or waste management concerns. Based on an initial environmental analysis, this project is not expected to result in significant negative effects on the local environment.

To facilitate your review, a site plot of the proposed FEP/DUP facilities is also enclosed. Your comments will be included in the ER that will be submitted to the Nuclear Regulatory Commission (NRC) for review.

We would appreciate receiving your comments within 30 days. Should you have any questions or need additional information, please contact me at (208) 524-5300.

Sincerely,

Steve Laflin, President and CEO
International Isotopes, Inc.

Enclosure: Proposed INIS Fluorine Extraction Process and Depleted Uranium De-conversion Plant

cc: Richard Rose, Construction Programs Bureau
Vacant, Drinking Water Bureau

STL-2009-33

October 20 2009

Bill Brancard, Division Director
New Mexico Energy, Minerals and Natural Resources Division
1220 South St. Francis Drive
Santa Fe, New Mexico 87505

Dear Mr. Brancard,

International Isotopes, Inc (INIS) is proposing to construct an integrated Fluorine Extraction Process and Depleted Uranium Deconversion Plant (FEP/DUP) 14 miles west of Hobbs, New Mexico. The proposed facility will be constructed within Sections 26 and 27 of Township 18S, Range 37E. The INIS project will involve the construction of multiple buildings and an access road on the 600-acre site. Approximately 30 acres will be directly impacted by construction of the facility.

INIS is preparing an Environmental Report (ER) for this project. The ER will be submitted to the Nuclear Regulatory Commission (NRC) before the end of this year for their use in preparing an Environmental Impact Statement (EIS). We are notifying you about the project; and NRC will be scheduling, announcing, and conducting a public hearing on this project in the near future. We are asking for comments and information concerning the proposed facilities as they relate to threatened and endangered species, critical habitats, other wildlife, wetlands, and any other natural resource or waste management concerns. Based on an initial environmental analysis, this project is not expected to result in significant negative effects on the local environment.

To facilitate your review, a site plot of the proposed FEP/DUP facilities is also enclosed. Your comments will be included in the ER that will be submitted to the Nuclear Regulatory Commission (NRC) for review.

We would appreciate receiving your comments within 30 days. Should you have any questions or need additional information, please contact me at (208) 524-5300.

Sincerely,

Steve Laflin, President and CEO
International Isotopes, Inc.

Enclosure: Proposed INIS Fluorine Extraction Process and Depleted Uranium De-conversion Plant

cc: John T. Romero, P.E. Director Water Resources Allocation Program

STL-2009-34

October 20, 2009

Edward Rios, P.S., Division Manager
Office of Infrastructure Divisions
604 W. San Mateo
Santa Fe, New Mexico 87504

Dear Mr. Rios,

International Isotopes, Inc (INIS) is proposing to an integrated Fluorine Extraction Process and Depleted Uranium Deconversion Plant (FEP/DUP) 14 miles west of Hobbs, New Mexico. The proposed facility will be constructed within Sections 26 and 27 of Township 18S, Range 37E. The INIS project will involve the construction of multiple buildings and an access road on the 600-acre site. Approximately 30 acres will be directly impacted by construction of the facility.

INIS is preparing an Environmental Report (ER) for this project. The ER will be submitted to the Nuclear Regulatory Commission (NRC) before the end of this year for their use in preparing an Environmental Impact Statement (EIS). We are notifying you about the project; and NRC will be scheduling, announcing, and conducting a public hearing on this project in the near future. We are asking for comments and information concerning the proposed facilities as they relate to transportation or land management resource concerns. Based on an initial environmental analysis, this project is not expected to result in significant negative effects on the local environment.

To facilitate your review, a site plot of the proposed FEP/DUP facilities is also enclosed. Your comments will be included in the ER that will be submitted to the Nuclear Regulatory Commission (NRC) for review.

We would appreciate receiving your comments within 30 days. Should you have any questions or need additional information, please contact me at (208) 524-5300.

Sincerely,

Steve Laflin, President and CEO
International Isotopes, Inc.

Enclosure: Proposed INIS Fluorine Extraction Process and Depleted Uranium De-conversion Plant

STL-2009-38

October 20, 2009

Patrick H. Lyons, Commissioner of Public Lands
New Mexico State Land Office
310 Old Santa Fe Trail
P.O. Box 1148
Santa Fe, New Mexico 87504-1148

Dear Commissioner Lyons,

International Isotopes, Inc (INIS) is proposing to an integrated Fluorine Extraction Process and Depleted Uranium Deconversion Plant (FEP/DUP) 14 miles west of Hobbs, New Mexico. The proposed facility will be constructed within Sections 26 and 27 of Township 18S, Range 37E. The INIS project will involve the construction of multiple buildings and an access road on the 600-acre site. Approximately 30 acres will be directly impacted by construction of the facility.

INIS is preparing an Environmental Report (ER) for this project. The ER will be submitted to the Nuclear Regulatory Commission (NRC) before the end of this year for their use in preparing an Environmental Impact Statement (EIS). We are notifying you about the project; and NRC will be scheduling, announcing, and conducting a public hearing on this project in the near future. We are asking for comments and information concerning the proposed facilities as they relate to transportation or land management resource concerns. Based on an initial environmental analysis, this project is not expected to result in significant negative effects on the local environment.

To facilitate your review, a site plot of the proposed FEP/DUP facilities is also enclosed. Your comments will be included in the ER that will be submitted to the Nuclear Regulatory Commission (NRC) for review.

We would appreciate receiving your comments within 30 days. Should you have any questions or need additional information, please contact me at (208) 524-5300.

Sincerely,

Steve Laffin, President and CEO
International Isotopes, Inc.

Enclosure: Proposed INIS Fluorine Extraction Process and Depleted Uranium De-conversion Plant

STL-2009-37

October 20 2009

Ron Curry, Cabinet Secretary
New Mexico Environment Department
P.O. Box 5469
Santa Fe, New Mexico, 87502-5469

Dear Secretary Curry

International Isotopes, Inc (INIS) is proposing to construct an integrated Fluorine Extraction Process and Depleted Uranium Deconversion Plant (FEP/DUP) 14 miles west of Hobbs, New Mexico. The proposed facility will be constructed within Sections 26 and 27 of Township 18S, Range 37E. The INIS project will involve the construction of multiple buildings and an access road on the 600-acre site. Approximately 30 acres will be directly impacted by construction of the facility.

INIS is preparing an Environmental Report (ER) for this project. The ER will be submitted to the Nuclear Regulatory Commission (NRC) before the end of this year for their use in preparing an Environmental Impact Statement (EIS). We are notifying you about the project; and NRC will be scheduling, announcing, and conducting a public hearing on this project in the near future. We are asking for comments and information concerning the proposed facilities as they relate to threatened and endangered species, critical habitats, other wildlife, wetlands, and any other natural resource or waste management concerns. Based on an initial environmental analysis, this project is not expected to result in significant negative effects on the local environment.

To facilitate your review, a site plot of the proposed FEP/DUP facilities is also enclosed. Your comments will be included in the ER that will be submitted to the Nuclear Regulatory Commission (NRC) for review.

We would appreciate receiving your comments within 30 days. Should you have any questions or need additional information, please contact me at (208) 524-5300.

Sincerely,

Steve Laflin, President and CEO
International Isotopes, Inc.

Enclosure: Proposed INIS Fluorine Extraction Process and Depleted Uranium De-conversion Plant

cc: Jon Goldstein, Deputy Secretary
Tracy Hughes, Office of General Counsel
Carlo Romera, Division Director
Jim Norton, Division Director
Marcy Leavitt, Division Director
Karen Gallegos, Division Director

STL-2009-29

October 20 2009

Tod Stevenson, Director and Secretary to the Commission
State of New Mexico Department of Game & Fish
1 Wildlife Way
P.O. Box 25112
Santa Fe, NM 87504

Dear Mr. Stevenson,

International Isotopes, Inc (INIS) is proposing to construct an integrated Fluorine Extraction Process and Depleted Uranium Deconversion Plant (FEP/DUP) 14 miles west of Hobbs, New Mexico. The proposed facility will be constructed within Sections 26 and 27 of Township 18S, Range 37E. The INIS project will involve the construction of multiple buildings and an access road on the 600-acre site. Approximately 30 acres will be directly impacted by construction of the facility.

INIS is preparing an Environmental Report (ER) for this project. The ER will be submitted to the Nuclear Regulatory Commission (NRC) before the end of this year for their use in preparing an Environmental Impact Statement (EIS). We are notifying you about the project; and NRC will be scheduling, announcing, and conducting a public hearing on this project in the near future. We are asking for comments and information concerning the proposed facilities as they relate to threatened and endangered species, critical habitats, other wildlife, wetlands, and any other natural resource or waste management concerns. Based on an initial environmental analysis, this project is not expected to result in significant negative effects on the local environment.

To facilitate your review, a site plot of the proposed FEP/DUP facilities is also enclosed. Your comments will be included in the ER that will be submitted to the Nuclear Regulatory Commission (NRC) for review.

We would appreciate receiving your comments within 30 days. Should you have any questions or need additional information, please contact me at (208) 524-5300.

Sincerely,

Steve Laflin, President and CEO
International Isotopes, Inc.

Enclosure: Proposed INIS Fluorine Extraction Process and Depleted Uranium De-conversion Plant

cc: Matt Wunder, Conservation Services Division Chief
Roy Hayes, SE Area Operations Chief, NMGF; 1912 W. Second Street; Roswell, NM 88201
Alexa Sandoval, Administrative Services Division Chief NMGF
Vacant, Wildlife Management Division Chief, NMGF

STL-2009-28

October 20, 2009

Honorable Bill Richardson,
Office of the Governor
490 Old Santa Fe Trail
Room 400
Santa Fe, NM 87501

Dear Governor Richardson,

International Isotopes, Inc (INIS) is proposing to construct an integrated Fluorine Extraction Process and Depleted Uranium Deconversion Plant (FEP/DUP) 14 miles west of Hobbs, New Mexico. The proposed facility will be constructed within Sections 26 and 27 of Township 18S, Range 37E. The INIS project will involve the construction of multiple buildings and an access road on a 600-acre site. Approximately 30 acres will be directly impacted by construction of the facility.

INIS is preparing an Environmental Report (ER) for this project. The ER will be submitted to the Nuclear Regulatory Commission (NRC) before the end of this year for their use in preparing an Environmental Impact Statement (EIS). We are notifying you about the project; and NRC will be scheduling, announcing, and conducting a public hearing on this project in the near future. We are asking for comments concerning the proposed facilities as they relate to socioeconomic impact issues or other issues important to you. Based on an initial environmental analysis, this project is not expected to result in significant negative effects on the local environment.

To facilitate your review, a site plot of the proposed FEP/DUP facilities is also enclosed. Your comments will be included in the ER that will be submitted to the Nuclear Regulatory Commission (NRC) for review.

We would appreciate receiving your comments within 30 days. Should you have any questions or need additional information, please contact me at (208) 524-5300.

Sincerely,

Steve Laflin, President and CEO
International Isotopes, Inc.

Enclosure: Proposed INIS Fluorine Extraction Process and Depleted Uranium De-conversion Plant

cc: Diane Denish; Lieutenant Governor

STL-2009-27

October 20, 2009

Bob Forrest, Mayor
City of Carlsbad, NM
101 N Halagueno
Carlsbad, New Mexico 88221

Dear Mayor Forrest,

International Isotopes, Inc (INIS) is proposing to construct an integrated Fluorine Extraction Process and Depleted Uranium Deconversion Plant (FEP/DUP) 14 miles west of Hobbs, New Mexico. The proposed facility will be constructed within Sections 26 and 27 of Township 18S, Range 37E. The INIS project will involve the construction of multiple buildings and an access road on a 600-acre site. Approximately 30 acres will be directly impacted by construction of the facility.

INIS is preparing an Environmental Report (ER) for this project. The ER will be submitted to the Nuclear Regulatory Commission (NRC) before the end of this year for their use in preparing an Environmental Impact Statement (EIS). We are notifying you about the project; and NRC will be scheduling, announcing, and conducting a public hearing on this project in the near future. We are asking for comments concerning the proposed facilities as they relate to socioeconomic impact issues or other issues important to you. Based on an initial environmental analysis, this project is not expected to result in significant negative effects on the local environment.

To facilitate your review, a site plot of the proposed FEP/DUP facilities is also enclosed. Your comments will be included in the ER that will be submitted to the Nuclear Regulatory Commission (NRC) for review.

We would appreciate receiving your comments within 30 days. Should you have any questions or need additional information, please contact me at (208) 524-5300.

Sincerely,

Steve Laflin, President and CEO
International Isotopes, Inc.

Enclosure: Proposed INIS Fluorine Extraction Process and Depleted Uranium De-conversion Plant

STL-2009-26

October 20, 2009

Tom N. Keyes, Gaines County Judge
101 South Main, Room 110
P.O. Box 847
Seminole, Texas 79360

Dear Judge Keyes,

International Isotopes, Inc (INIS) is proposing to construct an integrated Fluorine Extraction Process and Depleted Uranium Deconversion Plant (FEP/DUP) 14 miles west of Hobbs, New Mexico. The proposed facility will be constructed within Sections 26 and 27 of Township 18S, Range 37E. The INIS project will involve the construction of multiple buildings and an access road on a 600-acre site. Approximately 30 acres will be directly impacted by construction of the facility.

INIS is preparing an Environmental Report (ER) for this project. The ER will be submitted to the Nuclear Regulatory Commission (NRC) before the end of this year for their use in preparing an Environmental Impact Statement (EIS). We are notifying you about the project; and NRC will be scheduling, announcing, and conducting a public hearing on this project in the near future. We are asking for comments concerning the proposed facilities as they relate to socioeconomic impact issues or other issues important to you. Based on an initial environmental analysis, this project is not expected to result in significant negative effects on the local environment.

To facilitate your review, a site plot of the proposed FEP/DUP facilities is also enclosed. Your comments will be included in the ER that will be submitted to the Nuclear Regulatory Commission (NRC) for review.

We would appreciate receiving your comments within 30 days. Should you have any questions or need additional information, please contact me at (208) 524-5300.

Sincerely,

Steve Laflin, President and CEO
International Isotopes, Inc.

Enclosure: Proposed INIS Fluorine Extraction Process and Depleted Uranium De-conversion Plant

STL-2009-25

October 20, 2009

Richard H. Dolgener, Andrews County Judge
201 N. Main, Rm 104
Andrews, Texas 79714

Dear Judge Dolgener,

International Isotopes, Inc (INIS) is proposing to construct an integrated Fluorine Extraction Process and Depleted Uranium Deconversion Plant (FEP/DUP) 14 miles west of Hobbs, New Mexico. The proposed facility will be constructed within Sections 26 and 27 of Township 18S, Range 37E. The INIS project will involve the construction of multiple buildings and an access road on a 600-acre site. Approximately 30 acres will be directly impacted by construction of the facility.

INIS is preparing an Environmental Report (ER) for this project. The ER will be submitted to the Nuclear Regulatory Commission (NRC) before the end of this year for their use in preparing an Environmental Impact Statement (EIS). We are notifying you about the project; and NRC will be scheduling, announcing, and conducting a public hearing on this project in the near future. We are asking for comments concerning the proposed facilities as they relate to socioeconomic impact issues or other issues important to you. Based on an initial environmental analysis, this project is not expected to result in significant negative effects on the local environment.

To facilitate your review, a site plot of the proposed FEP/DUP facilities is also enclosed. Your comments will be included in the ER that will be submitted to the Nuclear Regulatory Commission (NRC) for review.

We would appreciate receiving your comments within 30 days. Should you have any questions or need additional information, please contact me at (208) 524-5300.

Sincerely,

Steve Laflin, President and CEO
International Isotopes, Inc.

Enclosure: Proposed INIS Fluorine Extraction Process and Depleted Uranium De-conversion Plant

STL-2009-24

October 20, 2009

Wayne Mixon, Mayor
City of Seminole, Texas
302 South Main
Seminole, Texas 79360

Dear Mayor Mixon,

International Isotopes, Inc (INIS) is proposing to construct an integrated Fluorine Extraction Process and Depleted Uranium Deconversion Plant (FEP/DUP) 14 miles west of Hobbs, New Mexico. The proposed facility will be constructed within Sections 26 and 27 of Township 18S, Range 37E. The INIS project will involve the construction of multiple buildings and an access road on a 600-acre site. Approximately 30 acres will be directly impacted by construction of the facility.

INIS is preparing an Environmental Report (ER) for this project. The ER will be submitted to the Nuclear Regulatory Commission (NRC) before the end of this year for their use in preparing an Environmental Impact Statement (EIS). We are notifying you about the project; and NRC will be scheduling, announcing, and conducting a public hearing on this project in the near future. We are asking for comments concerning the proposed facilities as they relate to socioeconomic impact issues or other issues important to you. Based on an initial environmental analysis, this project is not expected to result in significant negative effects on the local environment.

To facilitate your review, a site plot of the proposed FEP/DUP facilities is also enclosed. Your comments will be included in the ER that will be submitted to the Nuclear Regulatory Commission (NRC) for review.

We would appreciate receiving your comments within 30 days. Should you have any questions or need additional information, please contact me at (208) 524-5300.

Sincerely,

Steve Laflin, President and CEO
International Isotopes, Inc.

Enclosure: Proposed INIS Fluorine Extraction Process and Depleted Uranium De-conversion Plant

STL-2009-22

October 20, 2009

Deborah C. Ponder, Acting Director
Region 6 Office of Environmental Justice and Tribal Affairs
1445 Ross Avenue, Suite 1200
Dallas, Texas 75202

Dear Ms. Ponder,

International Isotopes, Inc (INIS) is proposing to construct an integrated Fluorine Extraction Process and Depleted Uranium Deconversion Plant (FEP/DUP) 14 miles west of Hobbs, New Mexico. The proposed facility will be constructed within Sections 26 and 27 of Township 18S, Range 37E. The INIS project will involve the construction of multiple buildings and an access road on the 600-acre site. Approximately 30 acres will be directly impacted by construction of the facility.

INIS is preparing an Environmental Report (ER) for this project. The ER will be submitted to the Nuclear Regulatory Commission (NRC) before the end of this year for their use in preparing an Environmental Impact Statement (EIS). We are notifying you about the project; and NRC will be scheduling, announcing, and conducting a public hearing on this project in the near future. We are asking for comments concerning the proposed facilities as they relate to archeological, cultural and historical sites important to Native American groups. Based on an initial environmental analysis, this project is not expected to result in significant negative effects on the local environment.

To facilitate your review, a site plot of the proposed FEP/DUP facilities is enclosed. Your comments will be included in the ER that will be submitted to the Nuclear Regulatory Commission (NRC) for review.

We would appreciate receiving your comments within 30 days. Should you have any questions or need additional information, please contact me at (208) 524-5300.

Sincerely,

Steve Laflin, President and CEO
International Isotopes, Inc.

Enclosure: Proposed INIS Integrated De-conversion/Fluorine Extraction Process Facility

cc: Shirley Augurson, Associate Director Environmental Justice Team
Randy Gee, Associate Director Tribal Team
Mark Allen, Tribal Ombudsman
Jay Harris, GAP Project Officer and Tribal Liaison
Curtis Hicks, GAP Project Officer and Tribal Liaison

STL-2009-15

October 20, 2009

Michael Beverly, Lea County Manager
100 N. Main
Lovington, New Mexico 88260

Dear Mr. Beverly,

International Isotopes, Inc (INIS) is proposing to construct an integrated Fluorine Extraction Process and Depleted Uranium Deconversion Plant (FEP/DUP) 14 miles west of Hobbs, New Mexico. The proposed facility will be constructed within Sections 26 and 27 of Township 18S, Range 37E. The INIS project will involve the construction of multiple buildings and an access road on a 600-acre site. Approximately 30 acres will be directly impacted by construction of the facility.

INIS is preparing an Environmental Report (ER) for this project. The ER will be submitted to the Nuclear Regulatory Commission (NRC) before the end of this year for their use in preparing an Environmental Impact Statement (EIS). We are notifying you about the project; and NRC will be scheduling, announcing, and conducting a public hearing on this project in the near future. We are asking for comments concerning the proposed facilities as they relate to socioeconomic impact issues or other issues important to you. Based on an initial environmental analysis, this project is not expected to result in significant negative effects on the local environment.

To facilitate your review, a site plot of the proposed FEP/DUP facilities is also enclosed. Your comments will be included in the ER that will be submitted to the Nuclear Regulatory Commission (NRC) for review.

We would appreciate receiving your comments within 30 days. Should you have any questions or need additional information, please contact me at (208) 524-5300.

Sincerely,

Steve Laflin, President and CEO
International Isotopes, Inc.

Enclosure: Proposed INIS Fluorine Extraction Process and Depleted Uranium De-conversion Plant

STL-2009-23

October 20 2009

Carlo Romera, Division Director
Environmental Health Division
New Mexico Environment Department
P.O. Box 5469
Santa Fe, New Mexico, 87502-5469

Dear Mr. Romera,

International Isotopes, Inc (INIS) is proposing to construct an integrated Fluorine Extraction Process and Depleted Uranium Deconversion Plant (FEP/DUP) 14 miles west of Hobbs, New Mexico. The proposed facility will be constructed within Sections 26 and 27 of Township 18S, Range 37E. The INIS project will involve the construction of multiple buildings and an access road on the 600-acre site. Approximately 30 acres will be directly impacted by construction of the facility.

INIS is preparing an Environmental Report (ER) for this project. The ER will be submitted to the Nuclear Regulatory Commission (NRC) before the end of this year for their use in preparing an Environmental Impact Statement (EIS). We are notifying you about the project; and NRC will be scheduling, announcing, and conducting a public hearing on this project in the near future. We are asking for comments and information concerning the proposed facilities as they relate to threatened and endangered species, critical habitats, other wildlife, wetlands, and any other natural resource or waste management concerns. Based on an initial environmental analysis, this project is not expected to result in significant negative effects on the local environment.

To facilitate your review, a site plot of the proposed FEP/DUP facilities is also enclosed. Your comments will be included in the ER that will be submitted to the Nuclear Regulatory Commission (NRC) for review.

We would appreciate receiving your comments within 30 days. Should you have any questions or need additional information, please contact me at (208) 524-5300.

Sincerely,

Steve Laflin, President and CEO
International Isotopes, Inc.

Enclosure: Proposed INIS Fluorine Extraction Process and Depleted Uranium De-conversion Plant

cc: John Parker, Radiation Control Bureau
Ken Smith, Environment Health Bureau
Gary Beatty, District IV

STL-2009-30

October 20, 2009

Ms. Katherine Slick, Director
NM Historic Preservation Division
New Mexico Department of Cultural Affairs
Bataan Memorial Building
407 Galisteo Street, Suite 236
Santa Fe, NM 87501

Dear Ms. Slick,

International Isotopes, Inc (INIS) is proposing to an integrated Fluorine Extraction Process and Depleted Uranium Deconversion Plant (FEP/DUP) 14 miles west of Hobbs, New Mexico. The proposed facility will be constructed within Sections 26 and 27 of Township 18S, Range 37E. The INIS project will involve the construction of multiple buildings and an access road on the 600-acre site. Approximately 30 acres will be directly impacted by construction of the facility.

INIS is preparing an Environmental Report (ER) for this project. The ER will be submitted to the Nuclear Regulatory Commission (NRC) before the end of this year for their use in preparing an Environmental Impact Statement (EIS). We are notifying you about the project; and NRC will be scheduling, announcing, and conducting a public hearing on this project in the near future. We are asking for comments and information concerning the proposed facilities as they relate to historical and cultural resource concerns. Based on an initial environmental analysis, this project is not expected to result in significant negative effects on the local environment.

To facilitate your review, a site plot of the proposed FEP/DUP facilities is also enclosed. Your comments will be included in the ER that will be submitted to the Nuclear Regulatory Commission (NRC) for review.

We would appreciate receiving your comments within 30 days. Should you have any questions or need additional information, please contact me at (208) 524-5300.

Sincerely,

Steve Laffin, President and CEO
International Isotopes, Inc.

Enclosure: Proposed INIS Fluorine Extraction Process and Depleted Uranium De-conversion Plant

cc: Ms. Jan Biella, Deputy State Historic Preservation Officer
Lisa Meyer, Preservation Planning Manager
Michelle Ensey, State Archaeological Permits

STL-2009-39

October 20, 2009

John D'Antonio, P.E.
New Mexico State Engineer/Secretary, Interstate Stream Commission
130 South Capitol Street
Concha Ortiz y Pino Building
P.O. Box 25102
Santa Fe, New Mexico 87504-5102

Dear Mr. D'Antonio:

International Isotopes, Inc (INIS) is proposing to construct an integrated Fluorine Extraction Process and Depleted Uranium Deconversion Plant (FEP/DUP) 14 miles west of Hobbs, New Mexico. The proposed facility will be constructed within Sections 26 and 27 of Township 18S, Range 37E. The INIS project will involve the construction of multiple buildings and an access road on the 600-acre site. Approximately 30 acres will be directly impacted by construction of the facility.

INIS is preparing an Environmental Report (ER) for this project. The ER will be submitted to the Nuclear Regulatory Commission (NRC) before the end of this year for their use in preparing an Environmental Impact Statement (EIS). We are notifying you about the project; and NRC will be scheduling, announcing, and conducting a public hearing on this project in the near future. We are asking for comments and information concerning the proposed facilities as they relate to water resource concerns. Based on an initial environmental analysis, this project is not expected to result in significant negative effects on the local environment.

To facilitate your review, a site map of the project area has been included. Additionally, a site plot of the proposed FEP/DUP facilities is also enclosed. Your comments will be included in the ER that will be submitted to the Nuclear Regulatory Commission (NRC) for review.

We would appreciate receiving your comments within 30 days. Should you have any questions or need additional information, please contact me at (208) 524-5300.

Sincerely,

Steve Laflin, President and CEO
International Isotopes, Inc.

Enclosure: Proposed INIS Fluorine Extraction Process and Depleted Uranium De-conversion Plant

STL-2009-40

October 20, 2009

Richard A Ratlif, P. E., Radiation Control Program Director
Texas Department of State Health Services
P. O. Box 149347
Austin, Texas 78714-6688

Dear Mr. Ratlif;

International Isotopes, Inc (INIS) is proposing to construct an integrated Fluorine Extraction Process and Depleted Uranium Deconversion Plant (FEP/DUP) 14 miles west of Hobbs, New Mexico. The proposed facility will be constructed within Sections 26 and 27 of Township 18S, Range 37E. The INIS project will involve the construction of multiple buildings and an access road on the 600-acre site. Approximately 30 acres will be directly impacted by construction of the facility.

INIS is preparing an Environmental Report (ER) for this project. The ER will be submitted to the Nuclear Regulatory Commission (NRC) before the end of this year for their use in preparing an Environmental Impact Statement (EIS). We are notifying you about the project; and NRC will be scheduling, announcing, and conducting a public hearing on this project in the near future. We are asking for comments and information concerning the proposed facilities as they relate to protecting the people of Texas from unnecessary radiation exposure. Based on an initial environmental analysis, this project is not expected to result in significant negative effects on the local environment.

To facilitate your review, a site plot of the proposed FEP/DUP facilities is also enclosed. Your comments will be included in the ER that will be submitted to the Nuclear Regulatory Commission (NRC) for review.

We would appreciate receiving your comments within 30 days. Should you have any questions or need additional information, please contact me at (208) 524-5300.

Sincerely,

Steve Laflin, President and CEO
International Isotopes, Inc.

Enclosure: Proposed INIS Fluorine Extraction Process and Depleted Uranium De-conversion Plant

STL-2009-42

October 20 2009

Ms. Joy Nicholopoulous, Ecological Services Field Supervisor
United States Department of the Interior
U.S. Fish & Wildlife Service
New Mexico Ecological Services Field Office
2105 Osuna Road NE
Albuquerque, NM 87113-1001

Dear Ms. Nicholopoulous,

International Isotopes, Inc (INIS) is proposing to construct an integrated Fluorine Extraction Process and Depleted Uranium Deconversion Plant (FEP/DUP) 14 miles west of Hobbs, New Mexico. The proposed facility will be constructed within Sections 26 and 27 of Township 18S, Range 37E. The INIS project will involve the construction of multiple buildings and an access road on the 600-acre site. Approximately 30 acres will be directly impacted by construction of the facility.

INIS is preparing an Environmental Report (ER) for this project. The ER will be submitted to the Nuclear Regulatory Commission (NRC) before the end of this year for their use in preparing an Environmental Impact Statement (EIS). We are notifying you about the project; and NRC will be scheduling, announcing, and conducting a public hearing on this project in the near future. We are asking for comments and information concerning the proposed facilities as they relate to threatened and endangered species, critical habitats, other wildlife, wetlands, and any other natural resource or waste management concerns. Based on an initial environmental analysis, this project is not expected to result in significant negative effects on the local environment.

To facilitate your review, a site plot of the proposed FEP/DUP facilities is also enclosed. Your comments will be included in the ER that will be submitted to the Nuclear Regulatory Commission (NRC) for review.

We would appreciate receiving your comments within 30 days. Should you have any questions or need additional information, please contact me at (208) 524-5300.

Sincerely,

Steve Laflin, President and CEO
International Isotopes, Inc.

Enclosure: Proposed INIS Fluorine Extraction Process and Depleted Uranium De-conversion Plant

cc: Susan MacMullin, Field Supervisor

STL-2009-35

October 20, 2009

Mr. Ed Roberson, Roswell Field Office Manager
Bureau of Land Management
2909 W. Second
Roswell, NM 88201

Dear Mr. Roberson,

International Isotopes, Inc (INIS) is proposing to an integrated Fluorine Extraction Process and Depleted Uranium Deconversion Plant (FEP/DUP) 14 miles west of Hobbs, New Mexico. The proposed facility will be constructed within Sections 26 and 27 of Township 18S, Range 37E. The INIS project will involve the construction of multiple buildings and an access road on the 600-acre site. Approximately 30 acres will be directly impacted by construction of the facility.

INIS is preparing an Environmental Report (ER) for this project. The ER will be submitted to the Nuclear Regulatory Commission (NRC) before the end of this year for their use in preparing an Environmental Impact Statement (EIS). We are notifying you about the project; and NRC will be scheduling, announcing, and conducting a public hearing on this project in the near future. We are asking for comments and information concerning the proposed facilities as they relate to transportation or land management resource concerns. Based on an initial environmental analysis, this project is not expected to result in significant negative effects on the local environment.

To facilitate your review, a site plot of the proposed FEP/DUP facilities is also enclosed. Your comments will be included in the ER that will be submitted to the Nuclear Regulatory Commission (NRC) for review.

We would appreciate receiving your comments within 30 days. Should you have any questions or need additional information, please contact me at (208) 524-5300.

Sincerely,

Steve Laffin, President and CEO
International Isotopes, Inc.

Enclosure: Proposed INIS Fluorine Extraction Process and Depleted Uranium De-conversion Plant

STL-2009-36



SL1

RECEIVED

OCT 23 2009

USFWS NMESFO

International Isotopes Inc.

October 20 2009

Ms. Joy Nicholopoulous, Ecological Services Field Supervisor
United States Department of the Interior
U.S. Fish & Wildlife Service
New Mexico Ecological Services Field Office
2105 Osuna Road NE
Albuquerque, NM 87113-1001

Dear Ms. Nicholopoulous,

International Isotopes, Inc (INIS) is proposing to construct an integrated Fluorine Extraction Process and Depleted Uranium Deconversion Plant (FEP/DUP) 14 miles west of Hobbs, New Mexico. The proposed facility will be constructed within Sections 26 and 27 of Township 18S Range 37E. The INIS project will involve the construction of multiple buildings and an access road on the 600-acre site. Approximately 30 acres will be directly impacted by construction of the facility.

INIS is preparing an Environmental Report (ER) for this project. The ER will be submitted to the Nuclear Regulatory Commission (NRC) before the end of this year for their use in preparing an Environmental Impact Statement (EIS). We are notifying you about the project; and NRC will be scheduling, announcing, and conducting a public hearing on this project in the near future. We are asking for comments and information concerning the proposed facilities as they relate to threatened and endangered species, critical habitats, other wildlife, wetlands, and any other natural resource or waste management concerns. Based on an initial environmental analysis, this project is not expected to result in significant negative effects on the local environment.

To facilitate your review, a site plot of the proposed FEP/DUP facilities is also enclosed. Your comments will be included in the ER that will be submitted to the Nuclear Regulatory Commission (NRC) for review.

We would appreciate receiving your comments within 30 days. Should you have any questions or need additional information, please contact me at (208) 524-5300.

Sincerely,

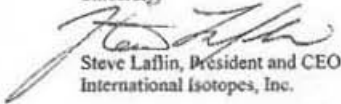
Steve Laffin, President and CEO
International Isotopes, Inc.

Enclosure: Proposed INIS Fluorine Extraction Process and Depleted Uranium De-conversion Plant

cc: Susan MacMullin, Field Supervisor

STL-2009-35



United States Department of the Interior

FISH AND WILDLIFE SERVICE
New Mexico Ecological Services Field Office
2105 Osuna NE
Albuquerque, New Mexico 87113
Phone: (505) 346-2525 Fax: (505) 346-2542

NOV - 4 2009

Thank you for your recent request for information on threatened or endangered species or important wildlife habitats that may occur in your project area. The New Mexico Ecological Services Field Office has posted lists of the endangered, threatened, proposed, candidate and species of concern occurring in all New Mexico Counties on the Internet. Please refer to the following web page for species information in the county where your project occurs: http://www.fws.gov/southwest/es/NewMexico/SBC_intro.cfm. If you do not have access to the Internet or have difficulty obtaining a list, please contact our office and we will mail or fax you a list as soon as possible.

After opening the web page, find New Mexico Listed and Sensitive Species Lists on the main page and click on the county of interest. Your project area may not necessarily include all or any of these species. This information should assist you in determining which species may or may not occur within your project area.

Under the Endangered Species Act of 1973, as amended (Act), it is the responsibility of the Federal action agency or its designated representative to determine if a proposed action "may affect" endangered, threatened, or proposed species, or designated critical habitat, and if so, to consult with us further. Similarly, it is their responsibility to determine if a proposed action has no effect to endangered, threatened, or proposed species, or designated critical habitat. On December 16, 2008, we published a final rule concerning clarifications to section 7 consultations under the Act (73 FR 76272). One of the clarifications is that section 7 consultation is not required in those instances when the direct and indirect effects of an action pose no effect to listed species or critical habitat. As a result, we do not provide concurrence with project proponent's "no effect" determinations.

If your action area has suitable habitat for any of these species, we recommend that species-specific surveys be conducted during the flowering season for plants and at the appropriate time for wildlife to evaluate any possible project-related impacts. Please keep in mind that the scope of federally listed species compliance also includes any interrelated or interdependent project activities (e.g., equipment staging areas, offsite borrow material areas, or utility relocations) and any indirect or cumulative effects.

Candidates and species of concern have no legal protection under the Act and are included on the web site for planning purposes only. We monitor the status of these species. If significant declines are detected, these species could potentially be listed as endangered or threatened. Therefore, actions that may contribute to their decline should be avoided. We recommend that candidates and species of concern be included in your surveys.

Also on the web site, we have included additional wildlife-related information that should be considered if your project is a specific type. These include communication towers, power line safety for raptors, road and highway improvements and/or construction, spring developments and livestock watering facilities, wastewater facilities, and trenching operations.

Under Executive Orders 11988 and 11990, Federal agencies are required to minimize the destruction, loss, or degradation of wetlands and floodplains, and preserve and enhance their natural and beneficial values. We recommend you contact the U.S. Army Corps of Engineers for permitting requirements under section 404 of the Clean Water Act if your proposed action could impact floodplains or wetlands. These habitats should be conserved through avoidance, or mitigated to ensure no net loss of wetlands function and value.

The Migratory Bird Treaty Act (MBTA) prohibits the taking of migratory birds, nests, and eggs, except as permitted by the U.S. Fish and Wildlife Service. To minimize the likelihood of adverse impacts to all birds protected under the MBTA, we recommend construction activities occur outside the general migratory bird nesting season of March through August, or that areas proposed for construction during the nesting season be surveyed and when occupied, avoided until nesting is complete.

We suggest you contact the New Mexico Department of Game and Fish, and the New Mexico Energy, Minerals, and Natural Resources Department, Forestry Division for information regarding fish, wildlife, and plants of State concern.

Thank you for your concern for endangered and threatened species and New Mexico's wildlife habitats. We appreciate your efforts to identify and avoid impacts to listed and sensitive species in your project area.

Sincerely,



Wally Murphy
Field Supervisor



International Isotopes Inc.

October 30, 2009

Henry Kostzuta, Chairman of Board
Apache Tribe of Oklahoma
PO Box 1220
Anadarko, OK 73005-1220

Dear Mr. Kostzuta:

International Isotopes, Inc. recently sent you a letter dated October 20, 2009, regarding comment and review of the proposed construction of an integrated Fluorine Extraction Process and Depleted Uranium De-conversion Plant (FEP/DUP) 14 miles west of Hobbs, New Mexico.

It was stated in the letter that the proposed facility would be constructed within Sections 26 and 27 of Township 18S, Range 37E.

The correct location for construction of the facility is:

Section 27 of Township 18S, Range 36E

We apologize for any inconvenience this may have caused.

I have also taken this opportunity to include some additional information on this important project. Further details can be obtained from our website www.internationalisotopes.com or by contacting our office.

We are looking forward to your response.

Sincerely,

Steve Laflin, President and CEO
International Isotopes, Inc.

STL-2009-43

4137 Commerce Circle, Idaho Falls, Idaho 83401
Phone: 208-524-5300, 800-699-3108 Fax: 208-524-1411
Website: www.intisoid.com



International Isotopes Inc.

October 30, 2009

Don (Donnie) Tofpi, Tribal Chairman
Kiowa Tribe of Oklahoma
PO Box 369
Carnegie, OK 73015-0369

Dear Mr. Tofpi:

International Isotopes, Inc. recently sent you a letter dated October 20, 2009, regarding comment and review of the proposed construction of an integrated Fluorine Extraction Process and Depleted Uranium De-conversion Plant (FEP/DUP) 14 miles west of Hobbs, New Mexico.

It was stated in the letter that the proposed facility would be constructed within Sections 26 and 27 of Township 18S, Range 37E.

The correct location for construction of the facility is:

Section 27 of Township 18S, Range 36E

We apologize for any inconvenience this may have caused.

I have also taken this opportunity to include some additional information on this important project. Further details can be obtained from our website www.internationalisotopes.com or by contacting our office.

We are looking forward to your response.

Sincerely,

Steve Laflin, President and CEO
International Isotopes, Inc.

STL-2009-44

4137 Commerce Circle, Idaho Falls, Idaho 83401
Phone: 208-524-5300, 800-699-3108 Fax: 208-524-1411
Website: www.intisoid.com



International Isotopes Inc.

October 30, 2009

Mark Chino, President
Mascalero Apache Tribe
PO Box 227
Mascalero, NM 88340

Dear Mr. Chino:

International Isotopes, Inc. recently sent you a letter dated October 20, 2009, regarding comment and review of the proposed construction of an integrated Fluorine Extraction Process and Depleted Uranium De-conversion Plant (FEP/DUP) 14 miles west of Hobbs, New Mexico.

It was stated in the letter that the proposed facility would be constructed within Sections 26 and 27 of Township 18S, Range 37E.

The correct location for construction of the facility is:

Section 27 of Township 18S, Range 36E

We apologize for any inconvenience this may have caused.

I have also taken this opportunity to include some additional information on this important project. Further details can be obtained from our website www.internationalisotopes.com or by contacting our office.

We are looking forward to your response.

Sincerely,

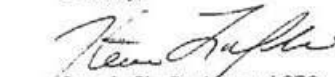

Steve Laflin, President and CEO
International Isotopes, Inc.

STL-2009-45

4137 Commerce Circle, Idaho Falls, Idaho 83401
Phone: 208-524-5300, 800-699-3108 Fax: 208-524-1411
Website: www.intisoid.com



International Isotopes Inc.

October 30, 2009

Bill Brancard, Division Director
New Mexico Energy, Minerals and Natural Resources Division
1220 South St. Francis Drive
Santa Fe, NM 87505

Dear Mr. Brancard:

International Isotopes, Inc. recently sent you a letter dated October 20, 2009, regarding comment and review of the proposed construction of an integrated Fluorine Extraction Process and Depleted Uranium De-conversion Plant (FEP/DUP) 14 miles west of Hobbs, New Mexico.

It was stated in the letter that the proposed facility would be constructed within Sections 26 and 27 of Township 18S, Range 37E.

The correct location for construction of the facility is:

Section 27 of Township 18S, Range 36E.

We apologize for any inconvenience this may have caused.

I have also taken this opportunity to include some additional information on this important project. Further details can be obtained from our website www.internationalisotopes.com or by contacting our office.

We are looking forward to your response.

Sincerely,

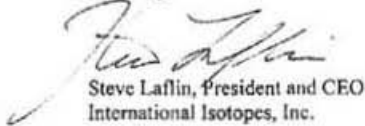

Steve Laflin, President and CEO
International Isotopes, Inc.

cc: John T. Romero, P.E., Director Water Resources Allocation Program

STL-2009-62

4137 Commerce Circle, Idaho Falls, Idaho 83401
Phone: 208-524-5300, 800-699-3108 Fax: 208-524-1411
Website: www.intisoid.com



International Isotopes Inc.

October 30, 2009

Frank Paiz, governor
Ysleta Del Sur Pueblo Tribe
PO Box 17579 - Ysleta Station
El Paso, TX 79917

Dear Mr. Paiz:

International Isotopes, Inc. recently sent you a letter dated October 20, 2009, regarding comment and review of the proposed construction of an integrated Fluorine Extraction Process and Depleted Uranium De-conversion Plant (FEP/DUP) 14 miles west of Hobbs, New Mexico.

It was stated in the letter that the proposed facility would be constructed within Sections 26 and 27 of Township 18S, Range 37E.

The correct location for construction of the facility is:

Section 27 of Township 18S, Range 36E.

We apologize for any inconvenience this may have caused.

I have also taken this opportunity to include some additional information on this important project. Further details can be obtained from our website www.internationalisotopes.com or by contacting our office.

We are looking forward to your response.

Sincerely,

Steve Laflin, President and CEO
International Isotopes, Inc.

STL-2009-46

4137 Commerce Circle, Idaho Falls, Idaho 83401
Phone: 208-524-5300, 800-699-3108 Fax: 208-524-1411
Website: www.intisoid.com



International Isotopes Inc.

October 30, 2009

Johnnie "Matt" White, Mayor
City of Eunice
Box 494
Eunice, NM 88231

Dear Mayor White:

International Isotopes, Inc. recently sent you a letter dated October 20, 2009, regarding comment and review of the proposed construction of an integrated Fluorine Extraction Process and Depleted Uranium De-conversion Plant (FEP/DUP) 14 miles west of Hobbs, New Mexico.

It was stated in the letter that the proposed facility would be constructed within Sections 26 and 27 of Township 18S, Range 37E.

The correct location for construction of the facility is:

Section 27 of Township 18S, Range 36E

We apologize for any inconvenience this may have caused.

We are looking forward to your response.

Sincerely,

Steve Laflin, President and CEO
International Isotopes, Inc.

STL-2009-47

4137 Commerce Circle, Idaho Falls, Idaho 83401
Phone: 208-524-5300, 800-699-3108 Fax: 208-524-1411
Website: www.intisoid.com



International Isotopes Inc.

October 30, 2009

Alton Dunn, Mayor
City of Jal
621 s. 4th Street
Jal, NM 88252

Dear Mayor Dunn:

International Isotopes, Inc. recently sent you a letter dated October 20, 2009, regarding comment and review of the proposed construction of an integrated Fluorine Extraction Process and Depleted Uranium De-conversion Plant (FEP/DUP) 14 miles west of Hobbs, New Mexico.

It was stated in the letter that the proposed facility would be constructed within Sections 26 and 27 of Township 18S, Range 37E.

The correct location for construction of the facility is:

Section 27 of Township 18S, Range 36E

We apologize for any inconvenience this may have caused.

I have also taken this opportunity to include some additional information on this important project. Further details can be obtained from our website www.internationalisotopes.com or by contacting our office.

We are looking forward to your response.

Sincerely,

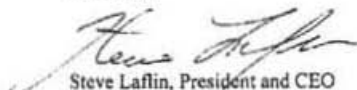

Steve Laffin, President and CEO
International Isotopes, Inc.

STL-2009-48

4137 Commerce Circle, Idaho Falls, Idaho 83401
Phone: 208-524-5300, 800-699-3108 Fax: 208-524-1411
Website: www.intisoid.com



International Isotopes Inc.

October 30, 2009

Betty C. Rickman, Mayor
City of Tatum
120 West Broadway
Tatum, NM 88267

Dear Mayor Rickman:

International Isotopes, Inc. recently sent you a letter dated October 20, 2009, regarding comment and review of the proposed construction of an integrated Fluorine Extraction Process and Depleted Uranium De-conversion Plant (FEP/DUP) 14 miles west of Hobbs, New Mexico.

It was stated in the letter that the proposed facility would be constructed within Sections 26 and 27 of Township 18S, Range 37E.

The correct location for construction of the facility is:

Section 27 of Township 18S, Range 36E

We apologize for any inconvenience this may have caused.

I have also taken this opportunity to include some additional information on this important project. Further details can be obtained from our website www.internationalisotopes.com or by contacting our office.

We are looking forward to your response.

Sincerely,

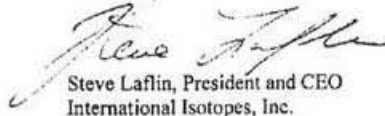

Steve Laffin, President and CEO
International Isotopes, Inc.

STL-2009-49

4137 Commerce Circle, Idaho Falls, Idaho 83401
Phone: 208-524-5300, 800-699-3108 Fax: 208-524-1411
Website: www.intisoid.com



International Isotopes Inc.

October 30, 2009

Wayne Mixon, Mayor
City of Seminole, Texas
302 South Main
Seminole, TX 79360

Dear Mayor Mixon:

International Isotopes, Inc. recently sent you a letter dated October 20, 2009, regarding comment and review of the proposed construction of an integrated Fluorine Extraction Process and Depleted Uranium De-conversion Plant (FEP/DUP) 14 miles west of Hobbs, New Mexico.

It was stated in the letter that the proposed facility would be constructed within Sections 26 and 27 of Township 18S, Range 37E.

The correct location for construction of the facility is:

Section 27 of Township 18S, Range 36E

We apologize for any inconvenience this may have caused.

I have also taken this opportunity to include some additional information on this important project. Further details can be obtained from our website www.internationalisotopes.com or by contacting our office.

We are looking forward to your response.

Sincerely,

Steve Laffin, President and CEO
International Isotopes, Inc.

STL-2009-50

4137 Commerce Circle, Idaho Falls, Idaho 83401
Phone: 208-524-5300, 800-699-3108 Fax: 208-524-1411
Website: www.intisoid.com



International Isotopes Inc.

October 30, 2009

Michael Beverly, Lea county Manager
100 N. Main
Lovington, NM 88260

Dear Mr. Beverly:

International Isotopes, Inc. recently sent you a letter dated October 20, 2009, regarding comment and review of the proposed construction of an integrated Fluorine Extraction Process and Depleted Uranium De-conversion Plant (FEP/DUP) 14 miles west of Hobbs, New Mexico.

It was stated in the letter that the proposed facility would be constructed within Sections 26 and 27 of Township 18S, Range 37E.

The correct location for construction of the facility is:

Section 27 of Township 18S, Range 36E

We apologize for any inconvenience this may have caused.

We are looking forward to your response.

Sincerely,

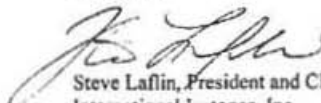

Steve Laflin, President and CEO
International Isotopes, Inc.

STL-2009-51

4137 Commerce Circle, Idaho Falls, Idaho 83401
Phone: 208-524-5300, 800-699-3108 Fax: 208-524-1411
Website: www.intisoid.com



International Isotopes Inc.

October 30, 2009

Richard H. Dolgener, Andrews County Judge
201 N. Main, Room 104
Andrews, TX 79714

Dear Honorable Dolgener:

International Isotopes, Inc. recently sent you a letter dated October 20, 2009, regarding comment and review of the proposed construction of an integrated Fluorine Extraction Process and Depleted Uranium De-conversion Plant (FEP/DUP) 14 miles west of Hobbs, New Mexico.

It was stated in the letter that the proposed facility would be constructed within Sections 26 and 27 of Township 18S, Range 37E.

The correct location for construction of the facility is:

Section 27 of Township 18S, Range 36E

We apologize for any inconvenience this may have caused.

We are looking forward to your response.

Sincerely,

Steve Laffin, President and CEO
International Isotopes, Inc.

STL-2009-52

4137 Commerce Circle, Idaho Falls, Idaho 83401
Phone: 208-524-5300, 800-699-3108 Fax: 208-524-1411
Website: www.intisoid.com



International Isotopes Inc.

October 30, 2009

Tom N. Keyes, Gaines County Judge
101 South Main, Room 110
PO Box 847
Seminole, TX 79360

Dear Honorable Keyes:

International Isotopes, Inc. recently sent you a letter dated October 20, 2009, regarding comment and review of the proposed construction of an integrated Fluorine Extraction Process and Depleted Uranium De-conversion Plant (FEP/DUP) 14 miles west of Hobbs, New Mexico.

It was stated in the letter that the proposed facility would be constructed within Sections 26 and 27 of Township 18S, Range 37E.

The correct location for construction of the facility is:

Section 27 of Township 18S, Range 36E

We apologize for any inconvenience this may have caused.

I have also taken this opportunity to include some additional information on this important project. Further details can be obtained from our website www.internationalisotopes.com or by contacting our office.

We are looking forward to your response.

Sincerely,



Steve Laflin, President and CEO
International Isotopes, Inc.

STL-2009-53

4137 Commerce Circle, Idaho Falls, Idaho 83401
Phone: 208-524-5300, 800-699-3108 Fax: 208-524-1411
Website: www.intisold.com



International Isotopes Inc.

October 30, 2009

Bob Forrest, Mayor
City of Carlsbad, NM
101 N Halagueno
Carlsbad, NM 88221

Dear Mayor Forrest:

International Isotopes, Inc. recently sent you a letter dated October 20, 2009, regarding comment and review of the proposed construction of an integrated Fluorine Extraction Process and Depleted Uranium De-conversion Plant (FEP/DUP) 14 miles west of Hobbs, New Mexico.

It was stated in the letter that the proposed facility would be constructed within Sections 26 and 27 of Township 18S, Range 37E.

The correct location for construction of the facility is:

Section 27 of Township 18S, Range 36E

We apologize for any inconvenience this may have caused.

We are looking forward to your response.

Sincerely,

Steve Laflin, President and CEO
International Isotopes, Inc.

STL-2009-54

4137 Commerce Circle, Idaho Falls, Idaho 83401
Phone: 208-524-5300, 800-699-3108 Fax: 208-524-1411
Website: www.intisoid.com



International Isotopes Inc.

October 30, 2009

Mr. Ed Roberson, Roswell Field Office Manager
Bureau of Land Management
2909 W. Second
Roswell, NM 88201

Dear Mr. Roberson:

International Isotopes, Inc. recently sent you a letter dated October 20, 2009, regarding comment and review of the proposed construction of an integrated Fluorine Extraction Process and Depleted Uranium De-conversion Plant (FEP/DUP) 14 miles west of Hobbs, New Mexico.

It was stated in the letter that the proposed facility would be constructed within Sections 26 and 27 of Township 18S, Range 37E.

The correct location for construction of the facility is:

Section 27 of Township 18S, Range 36E.

We apologize for any inconvenience this may have caused.

I have also taken this opportunity to include some additional information on this important project. Further details can be obtained from our website www.internationalisotopes.com or by contacting our office.

We are looking forward to your response.

Sincerely,

Steve Laflin, President and CEO
International Isotopes, Inc.

STL-2009-55

4137 Commerce Circle, Idaho Falls, Idaho 83401
Phone: 208-524-5300, 800-699-3108 Fax: 208-524-1411
Website: www.intisoid.com



International Isotopes Inc.

October 30, 2009

Patrick H. Lyons, Commissioner of Public Lands
New Mexico State Land office
310 Old Santa Fe Trail
PO Box 1148
Santa Fe, NM 87504-1148

Dear Commissioner Lyons:

International Isotopes, Inc. recently sent you a letter dated October 20, 2009, regarding comment and review of the proposed construction of an integrated Fluorine Extraction Process and Depleted Uranium De-conversion Plant (FEP/DUP) 14 miles west of Hobbs, New Mexico.

It was stated in the letter that the proposed facility would be constructed within Sections 26 and 27 of Township 18S, Range 37E.

The correct location for construction of the facility is:

Section 27 of Township 18S, Range 36E

We apologize for any inconvenience this may have caused.

We are looking forward to your response.

Sincerely,

Steve Laffin, President and CEO
International Isotopes, Inc.

STL-2009-56

4137 Commerce Circle, Idaho Falls, Idaho 83401
Phone: 208-524-5300, 800-699-3108 Fax: 208-524-1411
Website: www.intisoid.com



International Isotopes Inc.

October 30, 2009

Edward Rios, P.S., Division Manager
Office of Infrastructure Divisions
604 W. San Mateo
Santa Fe, NM 87504

Dear Mr. Rios:

International Isotopes, Inc. recently sent you a letter dated October 20, 2009, regarding comment and review of the proposed construction of an integrated Fluorine Extraction Process and Depleted Uranium De-conversion Plant (FEP/DUP) 14 miles west of Hobbs, New Mexico.

It was stated in the letter that the proposed facility would be constructed within Sections 26 and 27 of Township 18S, Range 37E.

The correct location for construction of the facility is:

Section 27 of Township 18S, Range 36E

We apologize for any inconvenience this may have caused.

I have also taken this opportunity to include some additional information on this important project. Further details can be obtained from our website www.internationalisotopes.com or by contacting our office.

We are looking forward to your response.

Sincerely,

Steve Laflin, President and CEO
International Isotopes, Inc.

STL-2009-57

4137 Commerce Circle, Idaho Falls, Idaho 83401
Phone: 208-524-5300, 800-699-3108 Fax: 208-524-1411
Website: www.intisoid.com



International Isotopes Inc.

October 30, 2009

John D'Antonio P.E.
New Mexico State Engineer/Secretary,
Interstate Stream Commission
120 South Capitol Street
Concha Oriz y Pino Building
PO Box 25102
Santa Fe, NM 87504-5102

Dear Mr. D'Antonio:

International Isotopes, Inc. recently sent you a letter dated October 20, 2009, regarding comment and review of the proposed construction of an integrated Fluorine Extraction Process and Depleted Uranium De-conversion Plant (FEP/DUP) 14 miles west of Hobbs, New Mexico.

It was stated in the letter that the proposed facility would be constructed within Sections 26 and 27 of Township 18S, Range 37E.

The correct location for construction of the facility is:

Section 27 of Township 18S, Range 36E

We apologize for any inconvenience this may have caused.

I have also taken this opportunity to include some additional information on this important project. Further details can be obtained from our website www.internationalisotopes.com or by contacting our office.

We are looking forward to your response.

Sincerely,

Steve Laffin, President and CEO
International Isotopes, Inc.

STL-2009-58

4137 Commerce Circle, Idaho Falls, Idaho 83401
Phone: 208-524-5300, 800-699-3108 Fax: 208-524-1411
Website: www.intisoid.com



International Isotopes Inc.

October 30, 2009

Gary King, New Mexico Attorney General
408 Galisteo Street
Villagra Building
PO Drawer 1508
Santa Fe, NM 87504-1508

Dear Mr. King:

International Isotopes, Inc. recently sent you a letter dated October 20, 2009, regarding comment and review of the proposed construction of an integrated Fluorine Extraction Process and Depleted Uranium De-conversion Plant (FEP/DUP) 14 miles west of Hobbs, New Mexico.

It was stated in the letter that the proposed facility would be constructed within Sections 26 and 27 of Township 18S, Range 37E.

The correct location for construction of the facility is:

Section 27 of Township 18S, Range 36E

We apologize for any inconvenience this may have caused.

I have also taken this opportunity to include some additional information on this important project. Further details can be obtained from our website www.internationalisotopes.com or by contacting our office.

We are looking forward to your response.

Sincerely,

Steve Laflin, President and CEO
International Isotopes, Inc.

STL-2009-59

4137 Commerce Circle, Idaho Falls, Idaho 83401
Phone: 208-524-5300, 800-699-3108 Fax: 208-524-1411
Website: www.intisoid.com



International Isotopes Inc.

October 30, 2009

Ms. Joy Nicholopoulos, Ecological Services Field Supervisor
United States Department of the Interior
U.S. Fish & Wildlife Service
New Mexico Ecological Services Field Office
2105 Osuna Road NE
Albuquerque, NM 87113-1001

Dear Ms. Nicholopoulos:

International Isotopes, Inc. recently sent you a letter dated October 20, 2009, regarding comment and review of the proposed construction of an integrated Fluorine Extraction Process and Depleted Uranium De-conversion Plant (FEP/DUP) 14 miles west of Hobbs, New Mexico.

It was stated in the letter that the proposed facility would be constructed within Sections 26 and 27 of Township 18S, Range 37E.

The correct location for construction of the facility is:

Section 27 of Township 18S, Range 36E

We apologize for any inconvenience this may have caused.

I have also taken this opportunity to include some additional information on this important project. Further details can be obtained from our website www.internationalisotopes.com or by contacting our office.

We are looking forward to your response.

Sincerely,

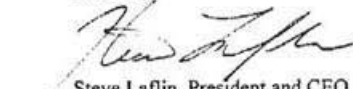

Steve Laflin, President and CEO
International Isotopes, Inc.

cc: Susan MacMullin, Field Supervisor

STL-2009-61

4137 Commerce Circle, Idaho Falls, Idaho 83401
Phone: 208-524-5300, 800-699-3108 Fax: 208-524-1411
Website: www.intisoid.com



International Isotopes Inc.

October 30, 2009

Bill Richardson, Governor
Office of the Governor
490 Old Santa Fe Trail
Room 400
Santa Fe, NM 87501

Dear Governor Richardson:

International Isotopes, Inc. recently sent you a letter dated October 20, 2009, regarding comment and review of the proposed construction of an integrated Fluorine Extraction Process and Depleted Uranium De-conversion Plant (FEP/DUP) 14 miles west of Hobbs, New Mexico.

It was stated in the letter that the proposed facility would be constructed within Sections 26 and 27 of Township 18S, Range 37E.

The correct location for construction of the facility is:

Section 27 of Township 18S, Range 36E

We apologize for any inconvenience this may have caused.

I have also taken this opportunity to include some additional information on this important project. Further details can be obtained from our website www.internationalisotopes.com or by contacting our office.

We are looking forward to your response.

Sincerely,

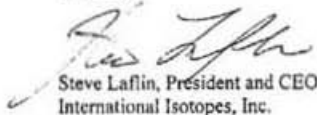

Steve Laflin, President and CEO
International Isotopes, Inc.

cc: Diane Denish; Lieutenant Governor

STL-2009-63

4137 Commerce Circle, Idaho Falls, Idaho 83401
Phone: 208-524-5300, 800-699-3108 Fax: 208-524-1411
Website: www.intisoid.com



International Isotopes Inc.

October 30, 2009

Dixie Drummond, Mayor
City of Lovington
214 South Love
Lovington, NM 88260

Dear Mayor Drummond:

International Isotopes, Inc. recently sent you a letter dated October 20, 2009, regarding comment and review of the proposed construction of an integrated Fluorine Extraction Process and Depleted Uranium De-conversion Plant (FEP/DUP) 14 miles west of Hobbs, New Mexico.

It was stated in the letter that the proposed facility would be constructed within Sections 26 and 27 of Township 18S, Range 37E.

The correct location for construction of the facility is:

Section 27 of Township 18S, Range 36E

We apologize for any inconvenience this may have caused.

I have also taken this opportunity to include some additional information on this important project. Further details can be obtained from our website www.internationalisotopes.com or by contacting our office.

We are looking forward to your response.

Sincerely,

Steve Laflin, President and CEO
International Isotopes, Inc.

cc: Pat Wise, City Manager

STL-2009-64

4137 Commerce Circle, Idaho Falls, Idaho 83401
Phone: 208-524-5300, 800-699-3108 Fax: 208-524-1411
Website: www.intisold.com



International Isotopes Inc.

October 30, 2009

Gary Don Regan, Mayor
City of Hobbs
200 E. Broadway
Hobbs, NM 88240

Dear Mayor Regan:

International Isotopes, Inc. recently sent you a letter dated October 20, 2009, regarding comment and review of the proposed construction of an integrated Fluorine Extraction Process and Depleted Uranium De-conversion Plant (FEP/DUP) 14 miles west of Hobbs, New Mexico.

It was stated in the letter that the proposed facility would be constructed within Sections 26 and 27 of Township 18S, Range 37E.

The correct location for construction of the facility is:

Section 27 of Township 18S, Range 36E

We apologize for any inconvenience this may have caused.

We are looking forward to your response.

Sincerely,

Steve Laffin, President and CEO
International Isotopes, Inc.

cc: Eric Honeyfield, City Manager

STL-2009-65

4137 Commerce Circle, Idaho Falls, Idaho 83401
Phone: 208-524-5300, 800-699-3108 Fax: 208-524-1411
Website: www.intisoid.com



International Isotopes Inc.

October 30, 2009

Robert Zap, Mayor
City of Andrews TX
111 Lodsdon
Andrews, TX 79714

Dear Mayor Zap:

International Isotopes, Inc. recently sent you a letter dated October 20, 2009, regarding comment and review of the proposed construction of an integrated Fluorine Extraction Process and Depleted Uranium De-conversion Plant (FEP/DUP) 14 miles west of Hobbs, New Mexico.

It was stated in the letter that the proposed facility would be constructed within Sections 26 and 27 of Township 18S, Range 37E.

The correct location for construction of the facility is:

Section 27 of Township 18S, Range 36E

We apologize for any inconvenience this may have caused.

We are looking forward to your response.

Sincerely,

Steve Laffin, President and CEO
International Isotopes, Inc.

cc: Glen E. Hackler, City Manager

STL-2009-66

4137 Commerce Circle, Idaho Falls, Idaho 83401
Phone: 208-524-5300, 800-699-3108 Fax: 208-524-1411
Website: www.intisoid.com



International Isotopes Inc.

October 30, 2009

Wallace Coffey, Tribal Chairman
Comanche Nation of Oklahoma Tribe
584 NW Bingo Road
HC 32 Box 1720
PO Box 908
Lawton, OK 73507

Dear Mr. Coffey:

International Isotopes, Inc. recently sent you a letter dated October 20, 2009, regarding comment and review of the proposed construction of an integrated Fluorine Extraction Process and Depleted Uranium De-conversion Plant (FEP/DUP) 14 miles west of Hobbs, New Mexico.

It was stated in the letter that the proposed facility would be constructed within Sections 26 and 27 of Township 18S, Range 37E.

The correct location for construction of the facility is:

Section 27 of Township 18S, Range 36E

We apologize for any inconvenience this may have caused.

I have also taken this opportunity to include some additional information on this important project. Further details can be obtained from our website www.internationalisotopes.com or by contacting our office.

We are looking forward to your response.

Sincerely,

Steve Laffin, President and CEO
International Isotopes, Inc.

cc: Jimmy Arterberry, NAGPRA Director

STL-2009-67

4137 Commerce Circle, Idaho Falls, Idaho 83401
Phone: 208-524-5300, 800-699-3108 Fax: 208-524-1411
Website: www.intisoid.com



International Isotopes Inc.

October 30, 2009

Karen Gallegos, Division Director
Water and Wastewater Infrastructure Development Division
New Mexico Environment Department
PO Box 5469
Santa Fe, NM 87502-5469

Dear Ms. Gallegos:

International Isotopes, Inc. recently sent you a letter dated October 20, 2009, regarding comment and review of the proposed construction of an integrated Fluorine Extraction Process and Depleted Uranium De-conversion Plant (FEP/DUP) 14 miles west of Hobbs, New Mexico.

It was stated in the letter that the proposed facility would be constructed within Sections 26 and 27 of Township 18S, Range 37E.

The correct location for construction of the facility is:

Section 27 of Township 18S, Range 36E.

We apologize for any inconvenience this may have caused.

I have also taken this opportunity to include some additional information on this important project. Further details can be obtained from our website www.internationalisotopes.com or by contacting our office.

We are looking forward to your response.

Sincerely,

Steve Laflin, President and CEO
International Isotopes, Inc.

cc: Richard Rose, Construction Programs Bureau
Vacant, Drinking Water Bureau

STL-2009-68

4137 Commerce Circle, Idaho Falls, Idaho 83401
Phone: 208-524-5300, 800-699-3108 Fax: 208-524-1411
Website: www.intisolid.com



International Isotopes Inc.

October 30, 2009

Ms. Katherine Slick, Director
NM Historic Preservation Division
New Mexico Department of Cultural Affairs
Bataan Memorial Building
407 Galisteo Street, Suite 236
Santa Fe, NM 87501

Dear Ms. Slick:

International Isotopes, Inc. recently sent you a letter dated October 20, 2009, regarding comment and review of the proposed construction of an integrated Fluorine Extraction Process and Depleted Uranium De-conversion Plant (FEP/DUP) 14 miles west of Hobbs, New Mexico.

It was stated in the letter that the proposed facility would be constructed within Sections 26 and 27 of Township 18S, Range 37E.

The correct location for construction of the facility is:

Section 27 of Township 18S, Range 36E

We apologize for any inconvenience this may have caused.

I have also taken this opportunity to include some additional information on this important project. Further details can be obtained from our website www.internationalisotopes.com or by contacting our office.

We are looking forward to your response.

Sincerely,

Steve Laffin, President and CEO
International Isotopes, Inc.

cc: Ms. Jan Biella, Deputy State Historic Preservation Officer
Lisa Meyer, Preservation Planning Manager
Michelle Ensey, State Archaeological Permits

STL-2009-69

4137 Commerce Circle, Idaho Falls, Idaho 83401
Phone: 208-524-5300, 800-699-3108 Fax: 208-524-1411
Website: www.intisoid.com



International Isotopes Inc.

October 30, 2009

Marcy Leavitt, Division Director
Water and Waste Management Division
New Mexico Environment Department
PO Box 5469
Santa Fe, NM 87502-5469

Dear Ms. Leavitt:

International Isotopes, Inc. recently sent you a letter dated October 20, 2009, regarding comment and review of the proposed construction of an integrated Fluorine Extraction Process and Depleted Uranium De-conversion Plant (FEP/DUP) 14 miles west of Hobbs, New Mexico.

It was stated in the letter that the proposed facility would be constructed within Sections 26 and 27 of Township 18S, Range 37E.

The correct location for construction of the facility is:

Section 27 of Township 18S, Range 36E.

We apologize for any inconvenience this may have caused.

I have also taken this opportunity to include some additional information on this important project. Further details can be obtained from our website www.internationalisotopes.com or by contacting our office.

We are looking forward to your response.

Sincerely,

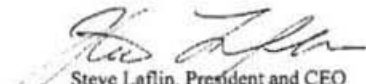

Steve Laflin, President and CEO
International Isotopes, Inc.

cc: James Bearzi, Hazardous Waste Bureau
Bill Oison, Groundwater Quality Bureau
Vacant, Surface Water Quality Bureau

STL-2009-70

4137 Commerce Circle, Idaho Falls, Idaho 83401
Phone: 208-524-5300, 800-699-3108 Fax: 208-524-1411
Website: www.intisoid.com



International Isotopes Inc.

October 30, 2009

Jim Norton, division Director
Environmental Protection Division
New Mexico Environment Department
PO Box 5469
Santa Fe, NM 87502-5469

Dear Mr. Norton:

International Isotopes, Inc. recently sent you a letter dated October 20, 2009, regarding comment and review of the proposed construction of an integrated Fluorine Extraction Process and Depleted Uranium De-conversion Plant (FEP/DUP) 14 miles west of Hobbs, New Mexico.

It was stated in the letter that the proposed facility would be constructed within Sections 26 and 27 of Township 18S, Range 37E.

The correct location for construction of the facility is:

Section 27 of Township 18S, Range 36E

We apologize for any inconvenience this may have caused.

I have also taken this opportunity to include some additional information on this important project. Further details can be obtained from our website www.internationalisotopes.com or by contacting our office.

We are looking forward to your response.

Sincerely,

Steve Laflin, President and CEO
International Isotopes, Inc.

cc: Auralie Ashley-Marx, Solid Waste Bureau
Mary Uhi, Air Quality Bureau
Butch Tongate, Occupational Health and Safety

STL-2009-71

4137 Commerce Circle, Idaho Falls, Idaho 83401
Phone: 208-524-5300, 800-899-3108 Fax: 208-524-1411
Website: www.intisoid.com



International Isotopes Inc.

October 30, 2009

Carlo Romera, Division Director
Environmental Health Department
New Mexico Environment Department
PO Box 5469
Santa Fe, NM 87502-5469

Dear Mr. Romera:

International Isotopes, Inc. recently sent you a letter dated October 20, 2009, regarding comment and review of the proposed construction of an integrated Fluorine Extraction Process and Depleted Uranium De-conversion Plant (FEP/DUP) 14 miles west of Hobbs, New Mexico.

It was stated in the letter that the proposed facility would be constructed within Sections 26 and 27 of Township 18S, Range 37E.

The correct location for construction of the facility is:

Section 27 of Township 18S, Range 36E

We apologize for any inconvenience this may have caused.

I have also taken this opportunity to include some additional information on this important project. Further details can be obtained from our website www.internationalisotopes.com or by contacting our office.

We are looking forward to your response.

Sincerely,

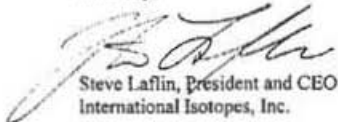

Steve Laffin, President and CEO
International Isotopes, Inc.

cc: John Parker, Radiation Control Bureau
Ken Smith, Environment Health Bureau
Gary Beatty, District IV

STL-2009-72

4137 Commerce Circle, Idaho Falls, Idaho 83401
Phone: 208-524-5300, 800-699-3108 Fax: 208-524-1411
Website: www.intisoid.com



International Isotopes Inc.

October 30, 2009

Tod Stevenson, Director and Secretary to the Commission
State of New Mexico Department of Game & Fish
1 Wildlife Way
PO Box 25112
Santa Fe, NM 87504

Dear Mr. Stevenson:

International Isotopes, Inc. recently sent you a letter dated October 20, 2009, regarding comment and review of the proposed construction of an integrated Fluorine Extraction Process and Depleted Uranium De-conversion Plant (FEP/DUP) 14 miles west of Hobbs, New Mexico.

It was stated in the letter that the proposed facility would be constructed within Sections 26 and 27 of Township 18S, Range 37E.

The correct location for construction of the facility is:

Section 27 of Township 18S, Range 36E

We apologize for any inconvenience this may have caused.

I have also taken this opportunity to include some additional information on this important project. Further details can be obtained from our website www.internationalisotopes.com or by contacting our office.

We are looking forward to your response.

Sincerely,

Steve Laffin, President and CEO
International Isotopes, Inc.

cc: Matt Wunder, Conservation Services Division Chief
Roy Hayes, SE Area Operations Chief, NMGF; 1912 W. Second Street; Roswell NM 88201
Alexa Sandoval, Administrative Services Division Chief, NMGF
Vacant, Wildlife Management Division Chief, NMGF

STL-2009-73

4137 Commerce Circle, Idaho Falls, Idaho 83401
Phone: 208-524-5300, 800-699-3108 Fax: 208-524-1411
Website: www.intisold.com



International Isotopes Inc.

October 30, 2009

Deborah C. Ponder, Acting Director
Region 6 Office of Environmental Justice and Tribal Affairs
1445 Ross Avenue, Suite 1200
Dallas, TX 75202

Dear Ms. Ponder:

International Isotopes, Inc. recently sent you a letter dated October 20, 2009, regarding comment and review of the proposed construction of an integrated Fluorine Extraction Process and Depleted Uranium De-conversion Plant (FEP/DUP) 14 miles west of Hobbs, New Mexico.

It was stated in the letter that the proposed facility would be constructed within Sections 26 and 27 of Township 18S, Range 37E.

The correct location for construction of the facility is:

Section 27 of Township 18S, Range 36E

We apologize for any inconvenience this may have caused.

I have also taken this opportunity to include some additional information on this important project. Further details can be obtained from our website www.internationalisotopes.com or by contacting our office.

We are looking forward to your response.

Sincerely,

Steve Laffin, President and CEO
International Isotopes, Inc.

cc: Shirley Augurson, Associate Director Environmental Justice Team
Randy Gee, Associate Director Tribal Team
Mark Allen, Tribal Ombudsman
Jay Harris, GAP Project Officer and Tribal Liaison
Curtis Hicks, GAP Project Officer and Tribal Liaison

STL-2009-74

4137 Commerce Circle, Idaho Falls, Idaho 83401
Phone: 208-524-5300, 800-699-3108 Fax: 208-524-1411
Website: www.intisoid.com



International Isotopes Inc.

October 30, 2009

Ron Curry
Cabinet Secretary
New Mexico Environment Department
PO Box 5469
Santa Fe, NM 87502-5469

Dear Mr. Curry:

International Isotopes, Inc. recently sent you a letter dated October 20, 2009, regarding comment and review of the proposed construction of an integrated Fluorine Extraction Process and Depleted Uranium De-conversion Plant (FEP/DUP) 14 miles west of Hobbs, New Mexico.

It was stated in the letter that the proposed facility would be constructed within Sections 26 and 27 of Township 18S, Range 37E.

The correct location for construction of the facility is:

Section 27 of Township 18S, Range 36E

We apologize for any inconvenience this may have caused.

We are looking forward to your response.

Sincerely,

Steve Laflin, President and CEO
International Isotopes, Inc.

cc: Jon Goldstein, Deputy Secretary
Tracy Hughes, Office of General Counsel
Jim Norton, Division Director
Marcy Leavitt, Division Director
Karen Gallegos, Division Director

STL-2009-75

4137 Commerce Circle, Idaho Falls, Idaho 83401
Phone: 208-524-5300, 800-699-3108 Fax: 208-524-1411
Website: www.intisoid.com

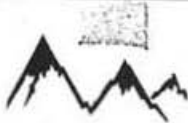

International Isotopes Inc.

October 30, 2009

Ms. Katherine Slick, Director
NM Historic Preservation Division
New Mexico Department of Cultural Affairs
Bataan Memorial Building
407 Galisteo Street, Suite 236
Santa Fe, NM 87501

AWI

088088

Dear Ms. Slick:

International Isotopes, Inc. recently sent you a letter dated October 20, 2009, regarding comment and review of the proposed construction of an integrated Fluorine Extraction Process and Depleted Uranium De-conversion Plant (FEP/DUP) 14 miles west of Hobbs, New Mexico.

It was stated in the letter that the proposed facility would be constructed within Sections 26 and 27 of Township 18S, Range 37E.

The correct location for construction of the facility is:

Section 27 of Township 18S, Range 36E

We apologize for any inconvenience this may have caused.

I have also taken this opportunity to include some additional information on this important project. Further details can be obtained from our website www.internationalisotopes.com or by contacting our office.

We are looking forward to your response.

Sincerely,

Steve Laflin
Steve Laflin, President and CEO
International Isotopes, Inc.

COMMENTS

Michelle Ensey 12/17/09
for NM State Historic Preservation Officer
Thank you for the corrected location.
Comments provided in our letter dated
November 24, 2009 apply to the corrected
location for construction of the facility.

cc: Ms. Jan Biella, Deputy State Historic Preservation Officer
Lisa Meyer, Preservation Planning Manager
Michelle Ensey, State Archaeological Permits

STL-2009-69

prev # 87989

4137 Commerce Circle, Idaho Falls, Idaho 83401
Phone: 208-524-5300, 800-699-3108 Fax: 208-524-1411
Website: www.intisoid.com



Michael Leighton
214 S. Love
Lovington, NM 88260

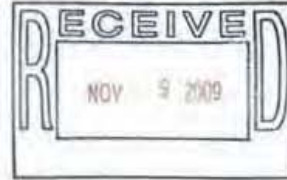

November 5, 2009

Mr. Steve Laffin
President & CEO
International Isotopes, Inc.
4137 Commerce Circle
Idaho Falls, Idaho 83401

Re: New Business

Dear Mr. Laffin:

On behalf of Mayor Dixie Drummond, the Lovington City Commission and the citizens of Lovington, New Mexico, I welcome your firm to our community.

We have reviewed your location map and information you have provided and see no problems whatsoever with having your business in our community. You will be closer to us than to Hobbs.

I look forward to your employees being an active part of our citizen base. I invite you to join both our Chamber of Commerce and our Economic Development Commission. These are their respective telephone numbers (575) 396-5311 (Ky Atwood) and (575) 396-1417, respectively

We have excellent schools, youth recreation and climate along with a stable and dedicated, work-force.

We anticipate creating and maintaining a great relationship with your firm far into the future. If Lovington can assist you, please do not hesitate to contact us at your convenience. I thank you in advance and await your contact.

Mr. Laflin
November 5, 2009
Page 2

Sincerely,



Michael Loughton
City Manager

c. Mayor & Commissioners
Ky Atwood
Leticia Kanmore
Lea EDC



cats U rule

Office (575) 396-2884 FAX (575) 396-6328 mleighton@lovington-nm.org



BILL RICHARDSON
Governor

NEW MEXICO
ENVIRONMENT DEPARTMENT

Office of the Secretary

Harold Runnels Building
1190 Saint Francis Drive (87505)
PO Box 26110, Santa Fe, NM 87502
Phone (505) 827-2855 Fax (505) 827-2836
www.nmenv.state.nm.us



RON CURRY
Secretary
Jon Goldstein
Deputy Secretary

November 9, 2009

Steve Latlin
President and CEO
International Isotopes, Inc.
4137 Commerce Circle
Idaho Falls, Idaho 83401



RE: Proposed Construction of an Integrated Fluorine Extraction Process and Depleted Uranium Deconversion Plant (FEP/DUP) West of the City of Hobbs, Lea County

Dear Mr.Latlin:

Your letter regarding the above named project was received in the New Mexico Environment Department (NMED) and was sent to various Bureaus for review and comment. Comments were provided by the Air Quality and Surface Water Quality Bureaus are as follows.

Air Quality Bureau

The proposed integrated Fluorine Extraction Process and Depleted Uranium Deconversion Plant 14 miles west of the City of Hobbs is located in Lea County. Lea County is currently considered to be in attainment with all New Mexico and National Ambient Air Quality Standards.

From the project description, it is difficult to discern what the potential is for fluorine emissions. However, fluorine is listed as a Toxic Air Pollutant (TAP) in New Mexico under 20.2.72.502 NMAC and potential emissions must be included in the NEPA analysis. Radionuclides are also identified and are subject to National Emission Standards for Hazardous Air Pollutants (NESHAP) in the Clean Air Act under 40 CFR Part 61.

Construction activities identified in this proposal have the potential to create temporary increases in emissions due to combustion-related construction activities and the use of earth-moving equipment. All asphalt, concrete, quarrying, crushing and screening facilities contracted in conjunction with the proposed project must have current and proper air quality permits. For more information on air quality permitting and modeling requirements, please refer to 20.2.72 NMAC.

Dust associated with vehicular use and earth-moving activities may also impact local air quality. However the increases should not result in non-attainment of air quality standards. Dust control measures should be considered to minimize the release of particulates due to vehicular traffic and ground disturbances. If activities result in significant ground disturbance, the project area should be reclaimed to avoid long-term problems with erosion and fugitive dust.

To further ensure air quality standards are met, applicable local or county regulations requiring noise and/or dust control must be followed. If none are in effect, controlling construction-related air quality impacts during projects should be considered to reduce the impact of fugitive dust and/or noise on community members.

Surface Water Quality Bureau

The U.S. Environmental Protection Agency (USEPA) requires National Pollutant Discharge Elimination System (NPDES) Construction General Permit (CGP) coverage for storm water discharges from construction projects (common plans of development) that will result in the disturbance (or re-disturbance) of one or more acres, including expansions, of total land area. Because this project exceeds one acre (including staging areas, etc.), it may require appropriate NPDES permit coverage prior to beginning construction (small, one - five acre, construction projects may be able to qualify for a waiver in lieu of permit coverage - see Appendix D).

Among other things, this permit requires that a Storm Water Pollution Prevention Plan (SWPPP) be prepared for the site and that appropriate Best Management Practices (BMPs) be installed and maintained both during and after construction to prevent, to the extent practicable, pollutants (primarily sediment, oil & grease and construction materials from construction sites) in storm water runoff from entering waters of the U.S. This permit also requires that permanent stabilization measures (revegetation, paving, etc.), and permanent storm water management measures (storm water detention/retention structures, velocity dissipation devices, etc.) be implemented post construction to minimize, in the long term, pollutants in storm water runoff from entering these waters. In addition, permittees must ensure that there is no increase in sediment yield and flow velocity from the construction site (both during and after construction) compared to pre-construction, undisturbed conditions (see Subpart 10.C.1.b)

You should also be aware that EPA requires that all "operators" (see Appendix A) obtain NPDES permit coverage for construction projects. Generally, this means that at least two parties will require permit coverage. The owner/developer of this construction project who has operational control over project specifications (probably INIS in this case), the general contractor who has day-to-day operational control of those activities at the site, which are necessary to ensure compliance with the storm water pollution plan and other permit conditions, and possibly other "operators" will require appropriate NPDES permit coverage for this project.

The CGP was re-issued effective June 30, 2008. The CGP, Notice of Intent (NOI), Fact Sheet, and Federal Register notice can be downloaded at:
<http://cfpub.epa.gov/npdes/stormwater/cgp.cfm>

In addition, USEPA requires NPDES Storm Water Multi-sector General Permit (MSGP) coverage for facilities that engage in "industrial activities" as defined at 40 Code of Federal Regulations Part 122.26(b)(14). Although the type of business to be operated is not entirely

clear in the submittal, if this business meets the definition of regulated industrial activity, it will require appropriate NPDES permit coverage prior to beginning operations.

Among other things, this permit also requires that a SWPPP be prepared for the site and that appropriate Best Management Practices (BMPs) be installed and maintained to prevent, to the extent practicable, pollutants in storm water runoff from entering waters of the U.S. A SWPPP should include such things as:

A description of potential pollutant sources - includes such things as a site map, an identification of the types of pollutants that are likely to be present in storm water discharges, an inventory of the types of materials handled at the site that potentially may be exposed to precipitation, a list of significant spills and leaks of oil, toxic or hazardous pollutants, sampling data, a narrative description of the potential pollutant sources from specific activities at the facility (i.e., pumping operations, road construction, raw material storage and handling, material transportation, fueling and other equipment maintenance), and identification of specific potential pollutants (i.e., dust, total suspended solids, total dissolved solids, turbidity, pH, nitrates, oil, grease, ethylene glycol, heavy metals, radionuclides, and others); and

A description of appropriate measures and controls - includes the type and location of existing and proposed non-structural and structural best management practices (BMPs) selected for each of the areas where industrial materials or activities are exposed to storm water. Non-structural and structural BMPs to be described and implemented include such things as good housekeeping, preventive maintenance, spill prevention and response procedures, periodic inspections, employee training, record keeping, non-storm water evaluations and certifications, sediment and erosion control, as well as implementation/maintenance of traditional storm water management practices (i.e., sediment/settling ponds, check dams, silt fences, straw bale barriers, perimeter berms, runoff diversion structures), where appropriate. The MSGP also requires preparation and implementation of a reclamation plan for the site.

The NPDES Storm Water Multi-Sector General Permit for Industrial Activities (MSGP) was re-issued effective September 29, 2008 (see **Federal Register/Vol. 73, No. 189/Monday, September 29, 2008** pg. 56572). The MSGP, Notice of Intent (NOI), Fact Sheet, and Federal Register notice can be downloaded at: <http://cfpub.epa.gov/npdes/stormwater/msgp.cfm>

Finally, USEPA requires individual NPDES permit coverage for discharges of process wastewaters. These permits typically contain both technology and water quality based effluent limits, sampling requirements, etc. NPDES regulations at 40 CFR Part 122.44(d) require that NPDES permits include effluent limits necessary to achieve water quality standards established under § 303 [33 U.S.C. 1313 - Water Quality Standards and Implementation Plans] of the federal Clean Water Act (CWA), including State narrative criteria for water quality. 40 CFR Part 122.4(j) requires that a discharge not "cause or contribute to the violation of water quality standards." The New Mexico Water Quality Control Commission (WQCC) has adopted surface water quality standards under authority of the New Mexico Water Quality Act [Chapter 74, Article 6 NMSA] pursuant to CWA § 303, which are codified as *Standards for Interstate and Intrastate Surface Waters, 20.6.4 NMAC*.

Regardless of whether or not an NPDES permit has been issued, state surface water quality standards must be met at all times and violation of these standards are enforced by the New Mexico Environment Department under authority of the New Mexico Water Quality Act.

I hope this information is helpful.

Sincerely,

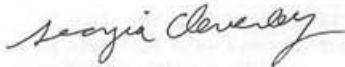

Georgia Cleverley
NMED File #3083



UNITED STATES ENVIRONMENTAL PROTECTION AGENCY
REGION 6
1445 ROSS AVENUE, SUITE 1200
DALLAS, TX 75202-2733

December 15, 2009

Mr. Steve Laffin
President and CEO
International Isotopes, Inc.
4137 Commerce Circle
Idaho Falls, ID 83401

Dear Mr. Laffin:

The Environmental Protection Agency (EPA) Region 6 has received your correspondence, dated October 20, 2009, requesting review of the proposed project(s). In accordance with the National Environmental Policy Act, and under Section 309 of the Clean Air Act, our agency has determined that no comments are necessary at this time. However, EPA would like to be placed on the mailing list to receive notifications and updates regarding this project, as they become available.

Please note that the proposed project(s) may be subject to other federal, state and local regulations. Thank you for your coordination and don't hesitate to contact me, Cathy Gilmore, at 214-665-6766 or gilmore.cathy@epa.gov should you have any questions regarding this letter.

Sincerely,

A handwritten signature in cursive script that reads "Cathy Gilmore".

Cathy Gilmore, Chief
Office of Planning and Coordination
Compliance Assurance and Enforcement Division

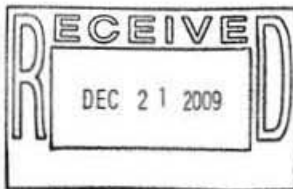

Table C-1 Census Block Groups Within Kilometers (50 Miles) of the Proposed IIFP Site^a

County/ Tract	Block Group	Persons	Below Poverty Level (%)	White (%)	African American/ Black (%)	American Indian and Alaskan Native (%)	Asian or Other Pacific Islander (%)	Other Race (%)	Two or More Races (%)	Hispanic or Latino (All Races) (%)	Minorities (Racial Minorities Plus White Hispanics) (%)
<i>State of New Mexico</i>		1,819,046	18.4	66.8	2.1	10.2	1.1	19.0	0.6	42.1	55.3
<i>Threshold for Environmental Justice Concerns</i>			38.4	—	22.1	30.2	21.4	39.0	20.6	50.0/42.1	50.0
<i>Eddy County</i>											
	000700	759	15.1	75.8	0.8	1.3	0.1	21.5	0.5	39.3	41.7
	000800	654	20.5	65.2	0.3	1.8	0.2	32.3	0.2	66.8	68.6
	000900	136	13.9	77.4	0.8	2.7	0.1	18.5	0.6	34.1	37.0
<i>Lea County</i>											
	000100	935	21.9	52.5	5.2	1.4	1.2	39.5	0.2	65.0	72.6
	000100	829	28.1	57.2	5.3	2.4	0.5	34.0	0.6	52.4	60.9
	000100	682	54.8	42.1	3.1	1.0	0.2	53.1	0.6	73.9	77.4
	000200	677	30.7	64.0	0.7	2.1	0.2	32.3	0.7	58.5	60.7
	000200	592	32.9	47.8	6.4	1.9	0.0	43.1	0.8	62.8	69.6
	000200	585	24.9	67.4	0.5	1.2	0.7	30.3	0.0	47.7	50.4
	000200	563	32.9	61.6	2.5	2.0	0.7	32.5	0.7	55.2	59.7
	000200	565	52.1	42.7	4.3	1.6	0.0	51.3	0.2	71.2	75.9
	000300	686	30.3	24.8	39.8	1.9	0.0	32.8	0.7	52.9	92.3
	000300	810	46.7	42.2	7.8	2.1	0.0	47.0	0.9	69.0	78.8
	000300	820	41.6	43.7	11.0	1.2	0.4	43.3	0.5	70.1	81.8
	000300	985	56.9	52.8	4.9	0.2	0.4	41.4	0.3	63.4	68.9
	000400	775	57.0	27.5	21.3	1.3	0.3	48.6	1.0	68.0	91.0

County/ Tract	Block Group	Persons	Below Poverty Level (%)	White (%)	African American/ Black (%)	American Indian and Alaskan Native (%)	Asian or Other Pacific Islander (%)	Other Race (%)	Two or More Races (%)	Hispanic or Latino (All Races) (%)	Minorities (Racial Minorities Plus White Hispanics) (%)
000400	2	1,053	25.9	56.1	10.0	1.8	0.8	30.7	0.7	50.5	62.9
000400	3	661	42.8	31.0	21.0	1.1	0.8	44.8	1.4	68.8	90.8
000501	1	781	2.9	86.6	2.1	0.5	1.3	9.1	0.5	12.7	16.9
000501	2	848	7.2	84.3	1.7	3.1	0.1	10.7	0.1	22.8	27.5
000501	3	533	39.6	75.1	5.6	2.6	0.8	15.8	0.2	26.1	34.0
000501	4	1,063	16.7	80.1	3.5	1.8	0.9	13.0	0.9	20.9	26.6
000501	5	775	9.8	89.9	1.6	0.9	0.9	6.6	0.1	9.7	13.8
000501	6	718	7.2	83.6	3.5	1.5	0.1	11.0	0.3	18.2	24.0
000501	7	1,381	5.2	87.8	2.6	0.8	1.1	7.2	0.4	12.2	16.6
000502	1	920	25.4	69.0	4.6	1.2	0.0	24.6	0.7	35.9	42.4
000502	2	968	28.2	65.4	4.8	0.8	0.7	28.0	0.3	41.4	47.1
000502	3	1,002	16.9	71.6	6.4	1.4	0.0	20.4	0.3	31.1	38.5
000502	4	810	3.7	86.2	2.6	1.7	2.4	6.4	0.7	11.4	17.9
000502	5	1,052	15.3	77.3	2.5	1.1	0.9	18.1	0.3	25.2	29.6
000502	6	786	31.4	59.3	14.6	0.8	0.1	24.0	1.2	34.5	50.5
000600	1	805	4.8	89.7	2.4	1.2	1.4	5.3	0.0	10.8	15.9
000600	2	734	4.3	90.7	1.1	0.8	0.4	6.7	0.3	10.6	12.9
000600	3	901	4.7	76.1	2.1	1.6	0.0	20.0	0.2	30.7	34.2
000600	4	756	22.2	74.2	3.0	0.8	0.7	21.2	0.1	31.0	35.7
000600	5	811	23.0	38.7	14.2	1.0	0.0	45.4	0.7	66.1	81.3
000600	6	957	17.5	48.5	13.4	2.1	0.1	35.3	0.6	63.3	76.9
000600	7	906	11.4	59.3	7.5	2.8	1.4	28.5	0.6	41.8	52.8
000700	1	1,052	7.7	83.2	0.8	1.1	0.7	14.2	0.1	21.5	24.1
000700	2	1,899	1.7	68.6	9.1	3.7	0.7	17.8	0.1	40.7	54.2
000700	3	882	13.2	83.8	0.6	1.1	0.6	13.8	0.1	22.3	24.5
000700	4	812	13.8	83.1	0.9	1.6	0.1	14.2	0.1	18.2	20.7
000700	5	1,331	19.0	84.8	1.0	2.0	0.3	11.9	0.0	23.4	26.7
000700	6	1,930	13.7	85.6	1.0	1.3	1.2	10.5	0.4	16.4	19.9
000800	1	850	10.2	75.7	0.5	0.7	0.0	23.2	0.0	32.1	33.6
000800	2	618	3.6	82.0	0.5	1.5	0.2	15.5	0.3	24.8	26.9

County/ Tract	Block Group	Persons	Below Poverty Level (%)	White (%)	African American/ Black (%)	American Indian and Alaskan Native (%)	Asian or Other Pacific Islander (%)	Other Race (%)	Two or More Races (%)	Hispanic or Latino (All Races) (%)	Minorities (Racial Minorities Plus White Hispanics) (%)
000800	3	773	24.1	67.9	2.6	1.7	0.5	27.2	0.1	48.6	52.8
000800	4	655	25.6	66.3	0.9	0.8	0.5	31.6	0.0	41.2	44.3
000900	1	562	17.8	79.5	0.2	1.1	0.2	18.9	0.2	28.6	30.1
000900	2	726	24.1	57.3	1.4	2.6	0.0	38.3	0.4	51.1	53.9
000900	3	830	12.5	68.0	0.1	2.3	0.0	28.9	0.7	39.2	41.2
001002	1	819	24.4	53.7	2.0	2.0	0.5	41.8	0.1	55.3	58.6
001002	2	1,357	19.3	64.2	2.5	1.4	0.2	31.6	0.2	45.8	49.8
001002	3	975	22.6	60.3	2.1	0.8	1.4	35.4	0.0	51.7	54.6
001002	4	713	25.3	51.5	3.1	1.7	0.3	43.3	0.1	65.1	69.0
001002	5	945	28.4	53.3	10.5	1.3	0.1	34.8	0.0	56.9	68.9
001002	6	592	20.2	51.9	3.2	0.5	0.2	43.9	0.3	62.0	66.6
001002	7	853	31.3	68.8	0.1	2.0	0.6	28.3	0.2	47.4	49.4
001003	1	870	25.7	53.2	4.3	0.2	1.3	41.0	0.0	59.0	64.0
001003	2	1,080	20.4	53.2	1.9	1.4	0.1	42.9	0.6	64.5	67.8
001003	3	873	17.7	79.0	0.0	1.0	0.7	19.1	0.1	29.2	30.2
001003	4	813	8.4	77.5	3.9	1.1	0.4	16.6	0.5	27.1	32.7
001100	1	6	26.8	71.1	0.3	1.4	0.2	27.1	0.0	30.6	32.3
001100	3	980	21.6	71.4	1.1	0.2	1.1	26.1	0.0	35.0	37.2
001100	4	822	14.1	75.5	1.1	1.8	0.1	20.7	0.8	30.9	32.7
001100	5	612	11.3	82.0	1.4	2.0	0.3	14.0	0.5	21.9	25.0
Total New Mexico Block Groups											
State of Texas		20,851,820	15.4	71.0	11.7	0.9	3.0	13.0	0.4	32.0	47.6
Threshold for Environmental Justice Concerns			35.4	---	31.7	20.9	23.0	33.0	20.4	50.0/32.0	50.0
Andrews County											
950100	3	896	9.6	85.4	1.1	1.3	1.3	10.9	0.0	24.7	28.2
950100	4	591	9.9	84.3	0.5	1.9	2.9	10.5	0.0	19.8	25.9
950200	1	1,289	17.2	73.9	6.0	1.9	0.3	17.6	0.3	37.5	46.2

County/ Tract	Block Group	Persons	Below Poverty Level (%)	White (%)	African American/ Black (%)	American Indian and Alaskan Native (%)	Asian or Other Pacific Islander (%)	Other Race (%)	Two or More Races (%)	Hispanic or Latino (All Races) (%)	Minorities (Racial Minorities Plus White Hispanics) (%)
950200	2	923	19.8	68.8	2.7	0.9	1.1	26.4	0.1	49.8	54.9
950200	3	1,176	22.7	76.0	2.1	1.3	0.8	19.3	0.5	37.6	41.4
950200	6	692	7.2	75.4	2.2	1.0	0.3	21.1	0.0	41.2	43.5
950200	7	775	14.7	88.4	1.2	1.0	0.0	8.8	0.7	21.8	23.7
950200	8	752	0.0	94.7	0.4	0.7	2.0	2.1	0.1	5.1	8.8
950300	1	642	19.2	60.1	1.1	0.3	1.4	37.1	0.0	70.6	72.7
950300	2	593	22.4	72.2	3.7	1.0	0.0	22.9	0.2	55.3	59.5
950300	3	514	27.6	69.8	0.4	3.1	1.2	25.5	0.0	48.6	53.1
950300	4	914	15.7	69.4	2.0	2.2	0.3	25.7	0.4	54.2	57.3
950300	5	856	25.7	74.2	0.2	1.2	1.2	23.0	0.2	61.1	63.7
950400	6	420	9.8	86.9	0.5	0.2	1.7	10.7	0.0	35.0	37.9
950400	7	1,523	18.6	78.6	0.5	1.2	0.1	17.1	0.1	40.4	41.6
Ector County											
002200	1	622	10.0	82.3	0.2	1.2	0.0	16.1	0.3	37.8	39.3
002700	2	0	15.7	76.5	0.8	0.8	0.3	21.5	0.2	40.1	41.7
002700	4	690	17.1	64.4	1.8	1.3	0.2	31.7	0.6	59.1	61.9
003000	1	586	3.8	92.7	0.7	0.9	0.4	5.4	0.0	9.7	11.4
003000	2	38	2.8	88.8	0.3	1.7	0.3	8.9	0.0	14.8	16.7
Gaines County											
950100	1	246	25.2	80.6	0.5	1.4	0.0	16.8	0.7	35.2	36.5
950100	2	770	20.1	76.9	1.2	1.8	0.0	20.1	0.0	42.5	45.1
950100	3	778	21.3	68.1	7.5	0.1	0.1	23.5	0.6	56.9	65.6
950100	4	836	33.9	54.8	8.4	2.3	0.0	34.3	0.2	69.6	79.4
950100	5	584	20.6	78.3	2.4	0.0	0.0	18.7	0.7	37.5	41.4
950200	1	1,455	20.6	84.7	0.9	1.2	0.3	12.8	0.1	32.1	33.9
950200	2	2,470	17.7	83.4	1.2	1.1	0.0	14.0	0.3	23.4	24.9
950200	3	1,759	29.7	90.0	1.6	0.7	0.3	7.4	0.1	14.6	17.2
950300	1	818	24.5	70.8	5.5	1.7	0.7	21.1	0.1	57.2	62.6

County/ Tract	Block Group	Persons	Below Poverty Level (%)	White (%)	African American/ Black (%)	American Indian and Alaskan Native (%)	Asian or Other Pacific Islander (%)	Other Race (%)	Two or More Races (%)	Hispanic or Latino (All Races) (%)	Minorities (Racial Minorities Plus White Hispanics) (%)
950300	2	797	14.6	77.2	0.8	0.5	0.5	21.1	0.0	45.7	47.7
950300	3	1,243	16.2	91.1	1.5	0.5	0.6	6.4	0.1	18.7	21.8
950300	4	921	19.5	81.8	0.9	0.1	0.5	16.5	0.2	40.8	42.7
950300	5	1,281	21.1	78.0	3.1	2.7	1.1	15.1	0.0	49.3	53.9
Loving County											
950100	1	28	0.0	89.6	0.0	0.0	0.0	10.4	0.0	10.4	10.4
Terry County											
950100	3	41	15.8	82.1	0.0	2.2	0.0	15.8	0.0	36.0	36.2
Winkler County											
950200	1	720	17.0	80.4	1.3	0.3	0.0	17.2	0.8	36.5	38.1