A person in a white lab coat is holding a glowing, intricate fusion reactor core in their hands. The core is a complex, multi-colored structure with a bright yellow and orange glow, set against a dark blue background. The person's hands are visible, holding the core from the sides. The overall scene is illuminated by a soft, blue light, creating a futuristic and scientific atmosphere.

Developing a Regulatory Framework for Commercial Fusion Energy Systems

NRC Public Meeting

March 23, 2022

Agenda

Time	Topic	Speaker
1:00 pm	Introductions	NRC
1:15 pm	Identification and Characterization of Fusion Hazards	Dr. Patrick White
2:15 pm	Overview of Fusion Industry Association Member Company Commercial Device Operational & Off-Normal Safety Case	Andrew Holland, Fusion Industry Association & Derek Sutherland, CT Fusion
3:30 pm	Break	
3:40 pm	Overview of Tritium Handling Systems	Tyler Ellis, Commonwealth Fusion Systems
4:25 pm	Supplemental Discussion of the Helion Device Safety Case	David Kirtley, Helion Energy
4:55 pm	Question and Answer Period	
5:30 pm	Adjourn	

Identification and Characterization of Hazards for the Regulation of Commercial Fusion Reactors

Patrick White (r.patrick.white@gmail.com)

Nuclear Regulatory Commission Public Meeting – March 23, 2022

Meeting Topic: Developing Options for a Regulatory
Framework for Commercial Fusion Energy Systems

Development of regulation for fusion is challenging due to technology diversity and early stage of design

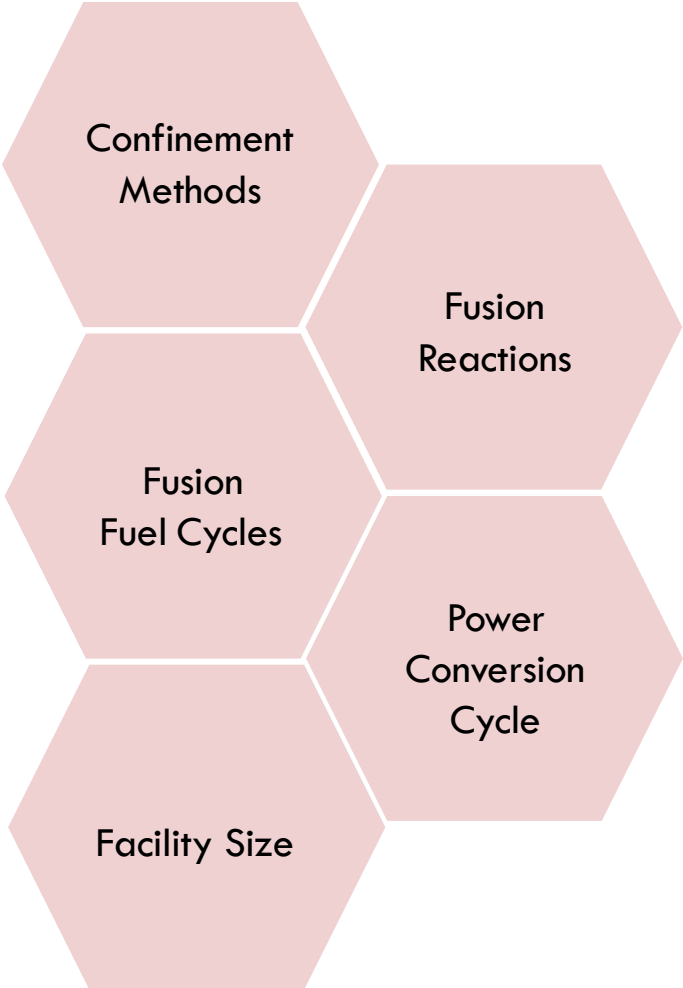

“First-principles” approach to regulation development can minimize or clarify *a priori* assumptions for novel activities

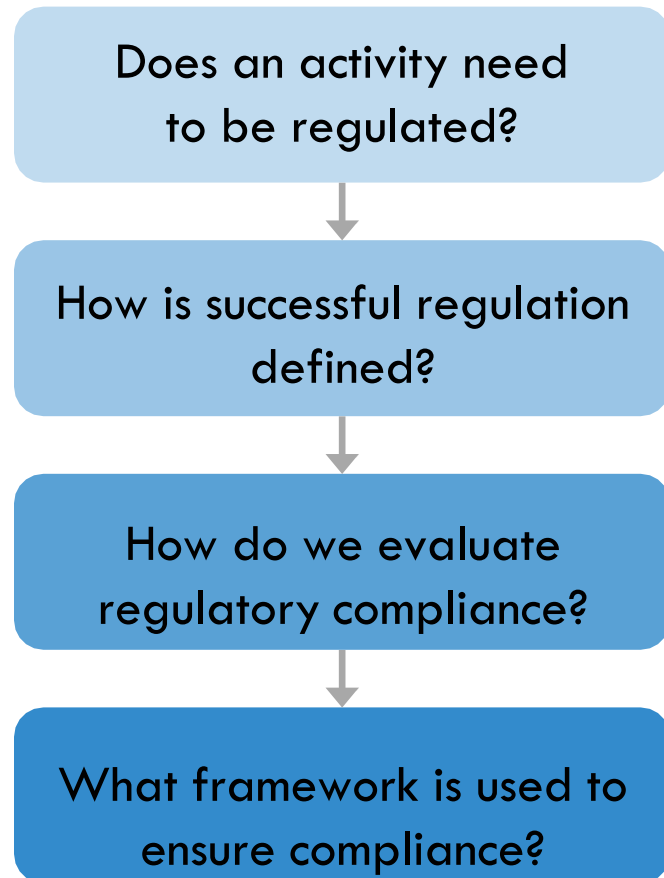

First-principles based licensing facilitates:

- Sound basis for regulatory regimes
- More consistent regulatory oversight
- Appropriate regulatory requirements

Commercial fusion regulation can be examined using a first principles paradigm to evaluate different regulatory options

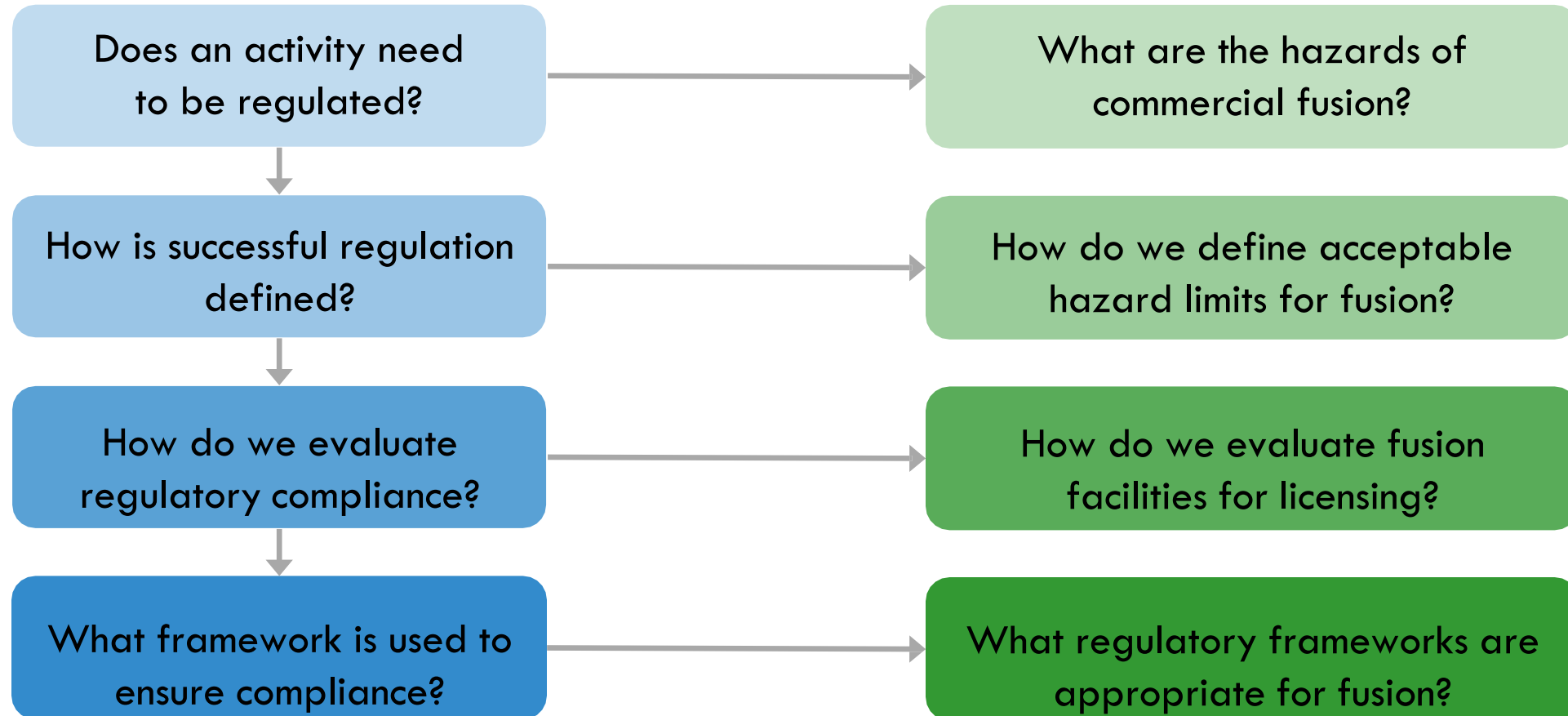

Commercial fusion regulation can be examined using a first principles paradigm to evaluate different regulatory options

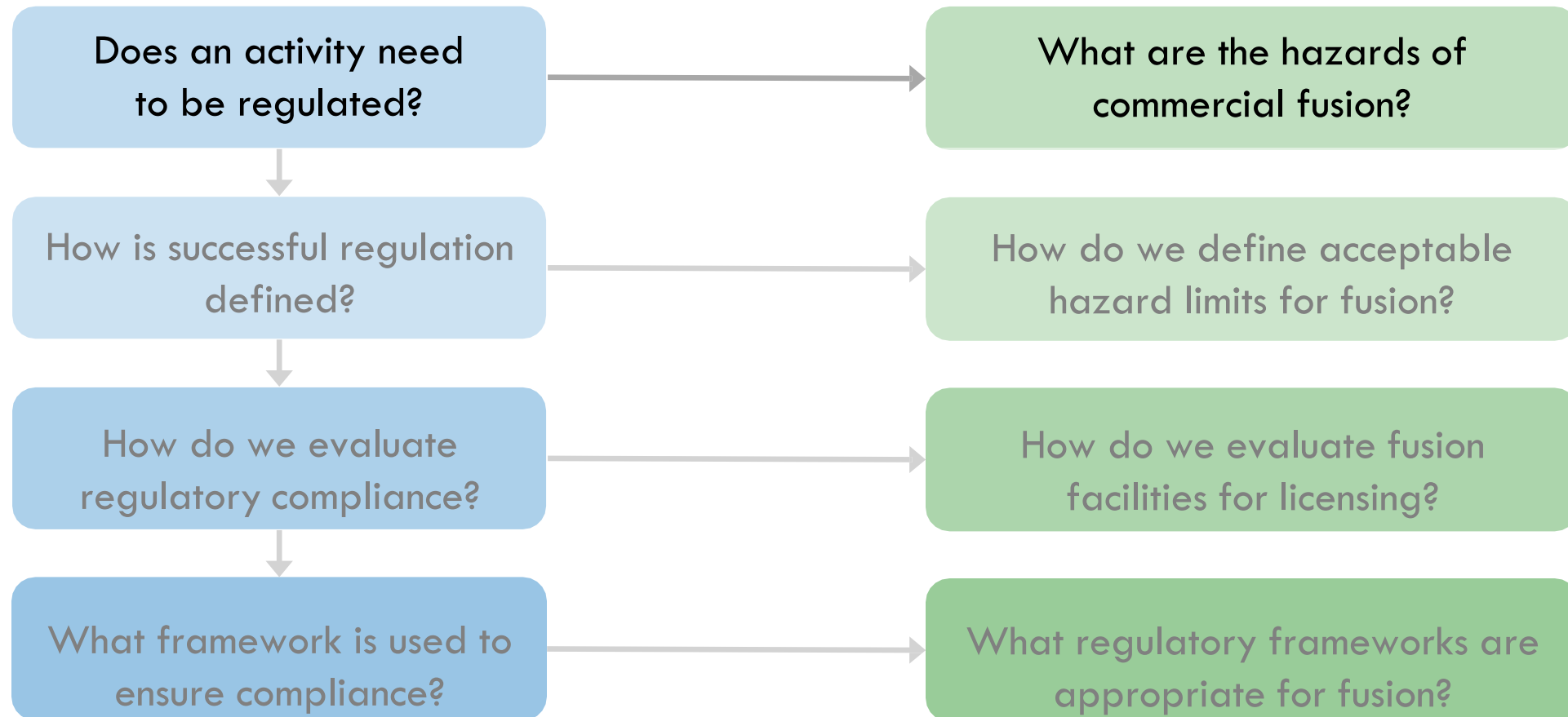

A generalized mental model for hazards and consequences facilitates qualitative understanding of hazardous activities

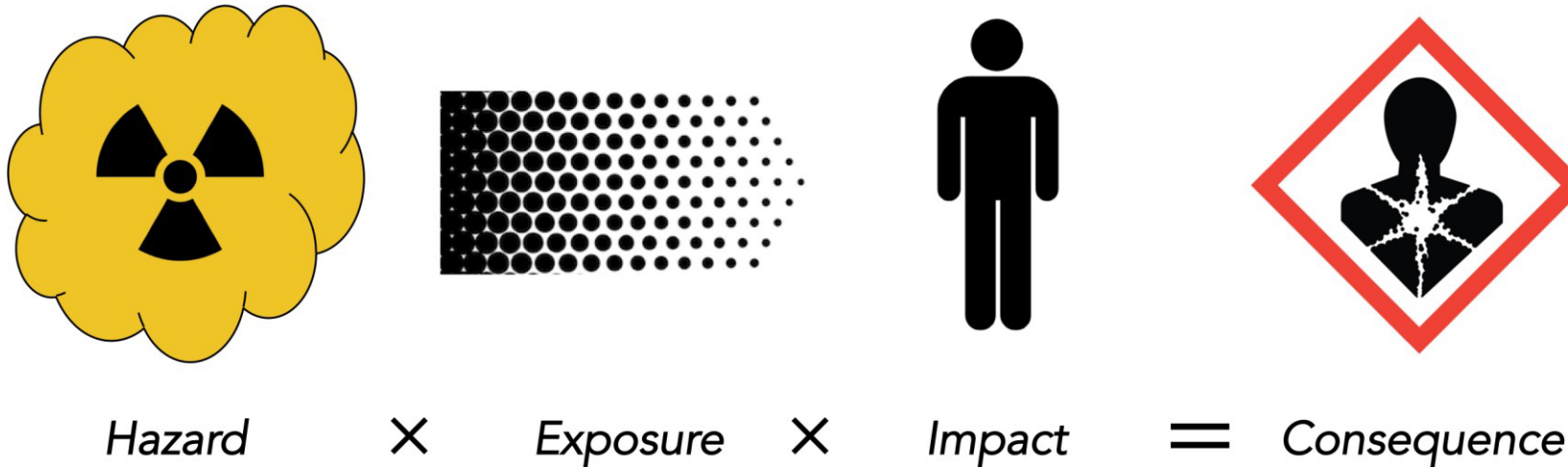

- Hazard: How much hazardous material is released/what is the hazard?
- Exposure: How much hazardous material/hazard affects people/property?
- Impact: What is the correlation of the exposure to consequences?

Detailed expansion of a generalized hazards and consequence model enables quantitative assessment

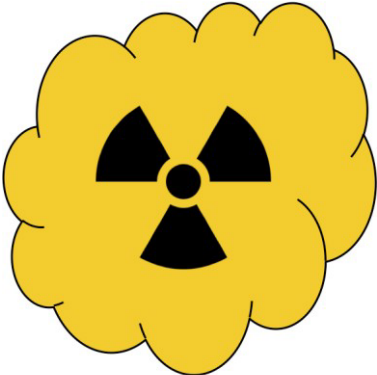

Hazard

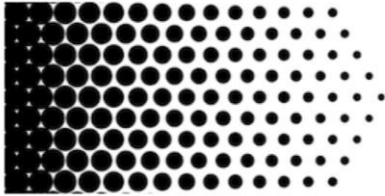

Exposure



Impact

Factors	Example
Hazard inventory	Total material or material vulnerable to release
Hazard inventory released	Fraction of material released
Hazard inventory release conditions	Time, location, form of the release

Factors	Example
Dispersion conditions	Meteorological, geographic, location factors that control dispersion
Exposure-dose conditions	Duration of exposure, physiological factors that affect total exposure

Factors	Example
Exposure-consequence relationships	Correlations between exposure and exposure consequences
Exposed population characteristics	Population distribution and characteristics that affect consequences

Identification and general characterization of hazards is fundamental to a first-principles approach to regulation

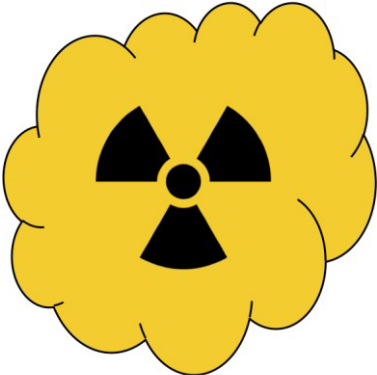

Hazard

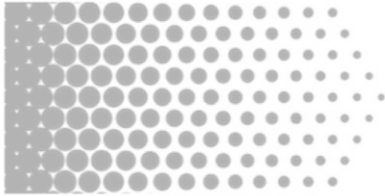

Exposure



Impact

Factors	Example
Hazard inventory	Total material or material vulnerable to release
Hazard inventory released	Fraction of material released
Hazard inventory release conditions	Time, location, form of the release

Factors	Example
Dispersion conditions	Meteorological, geographic, location factors that control dispersion
Exposure-dose conditions	Duration of exposure, physiological factors that affect total exposure

Factors	Example
Exposure-consequence relationships	Correlations between exposure and exposure consequences
Exposed population characteristics	Population distribution and characteristics that affect consequences

Structured method for assessing fusion hazards enables comparison of diverse technologies at different design stages



Variety of fusion technologies and limited design details makes general definition of fusion hazards challenging

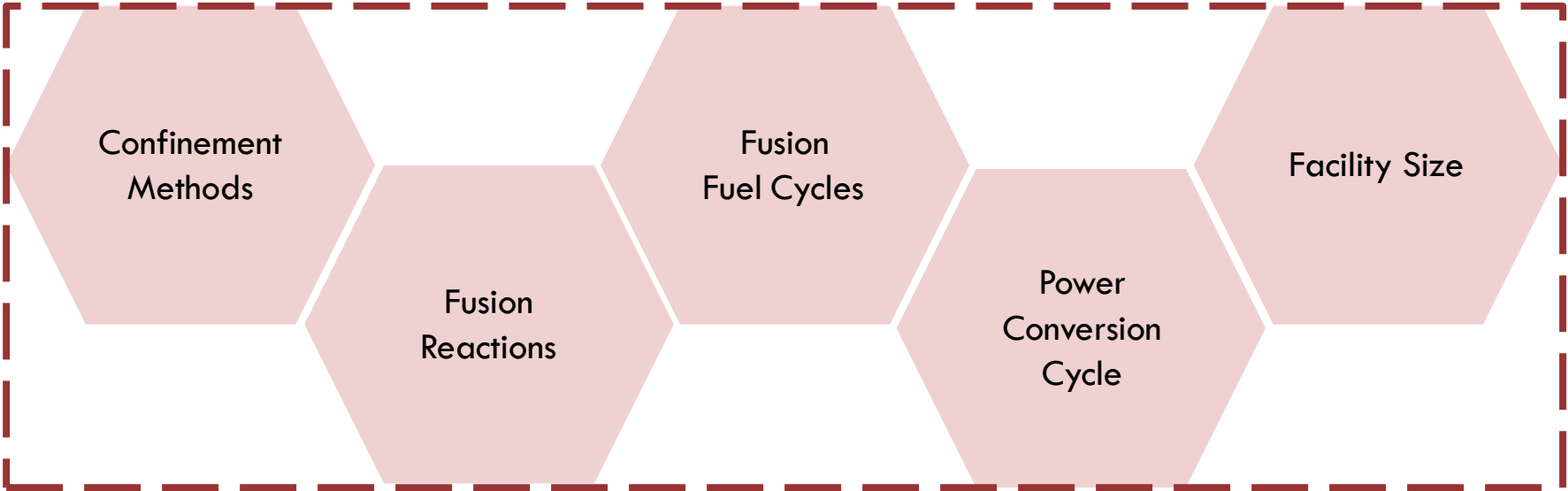

Systems engineering focus enables technology-independent characterization of fusion energy

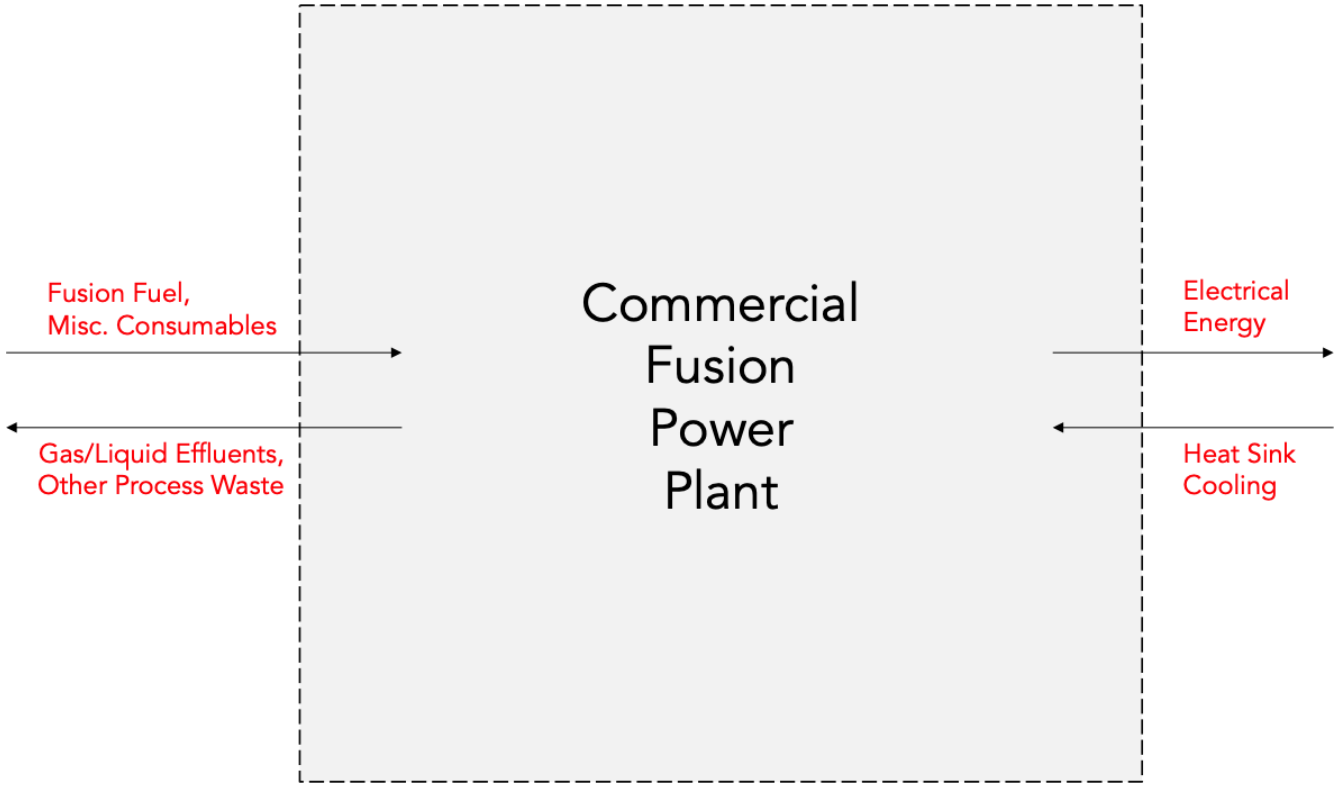

Function Block

Function

Commercial Fusion Power Plant	Produce net electricity from fusion energy
-------------------------------	--

Level 0 System Engineering Model:
Generalized Facility Concept Inputs and Outputs

First decomposition of functions characterizes general facility operations for a fusion facility

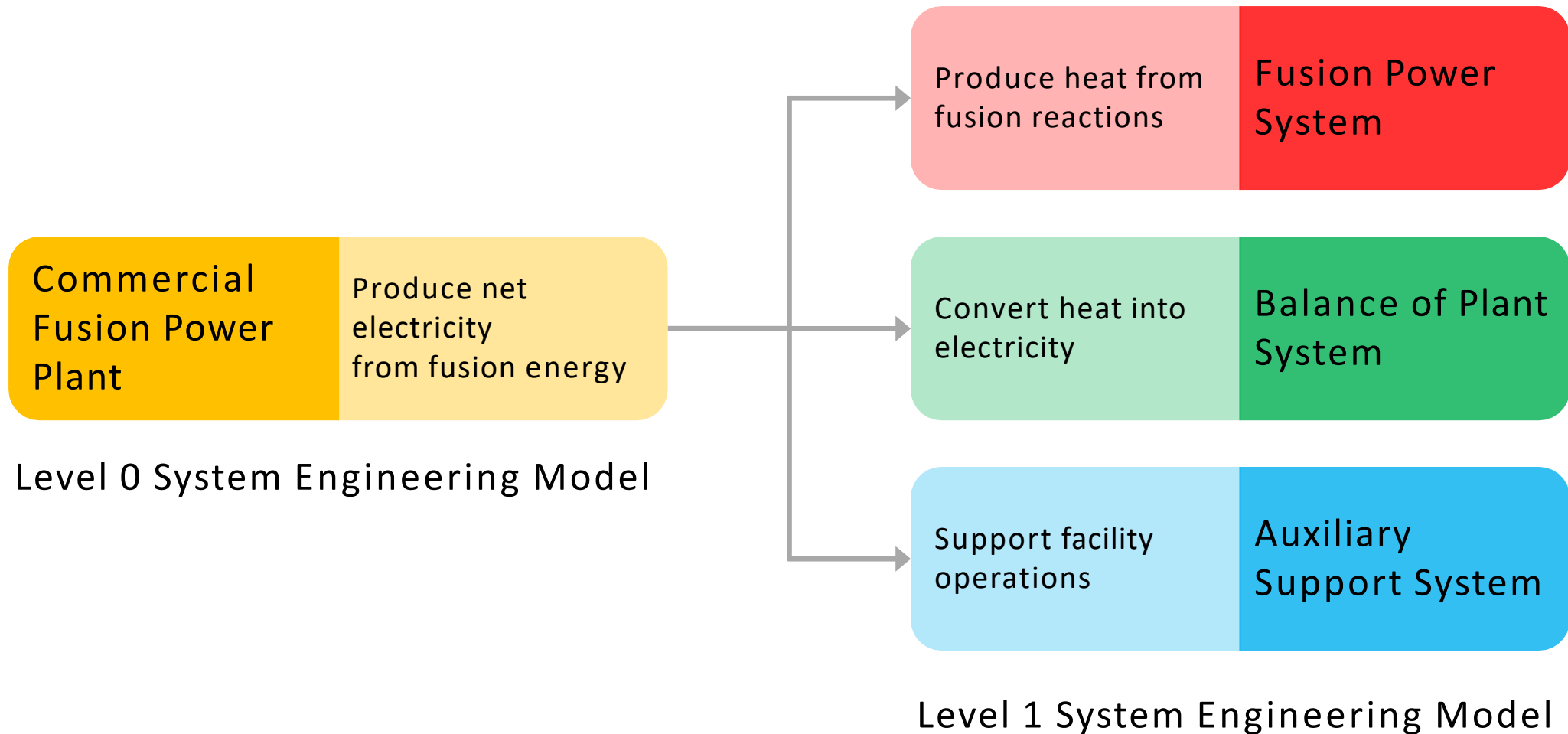



Definition of the Activity

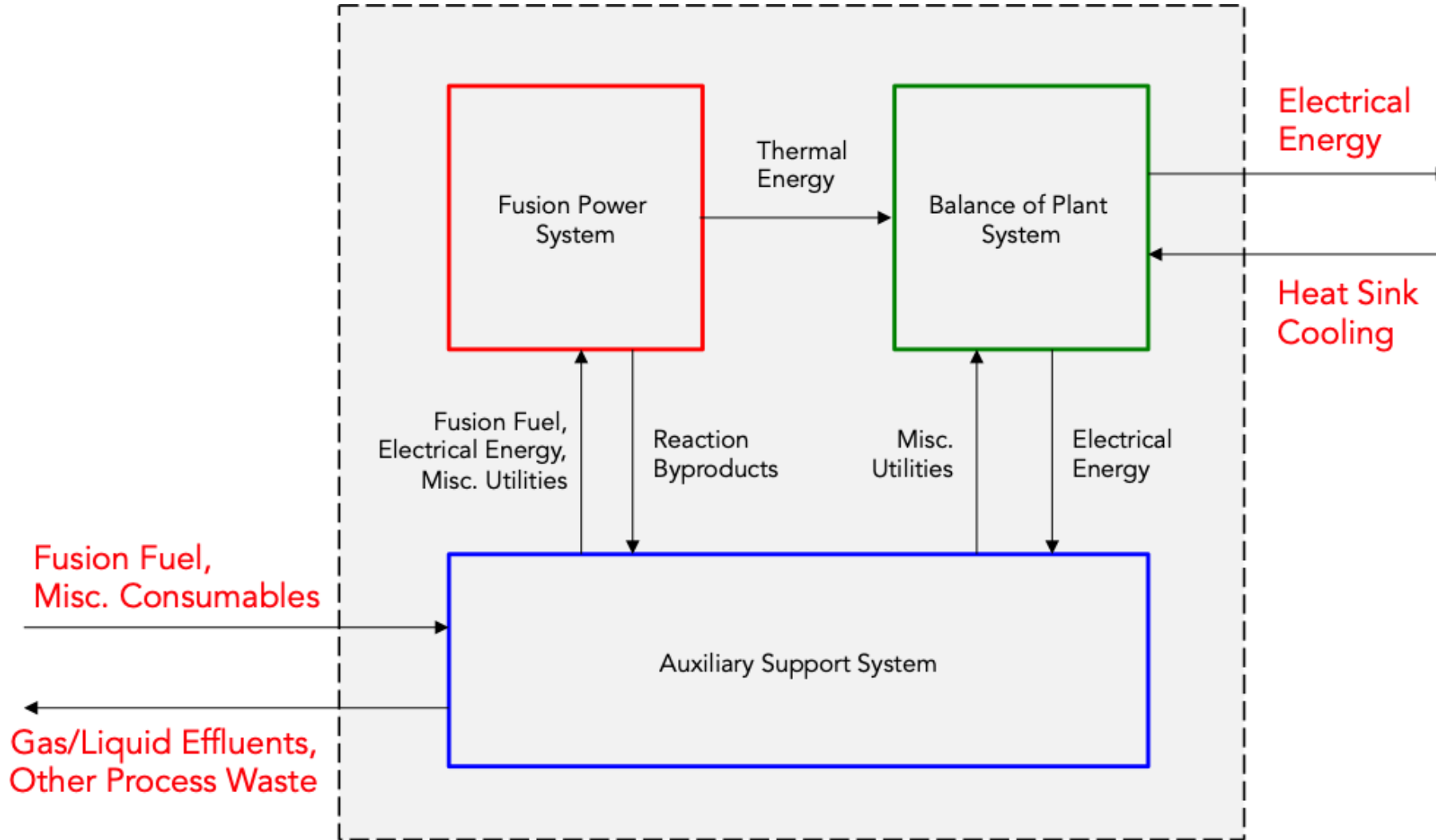

Level 1 System Engineering Model:
Generalized Plant Functions and Interfaces

Fundamental relationships between function blocks and external inputs emerge

Second decomposition of functions provides a simple conceptual model for a fusion facility

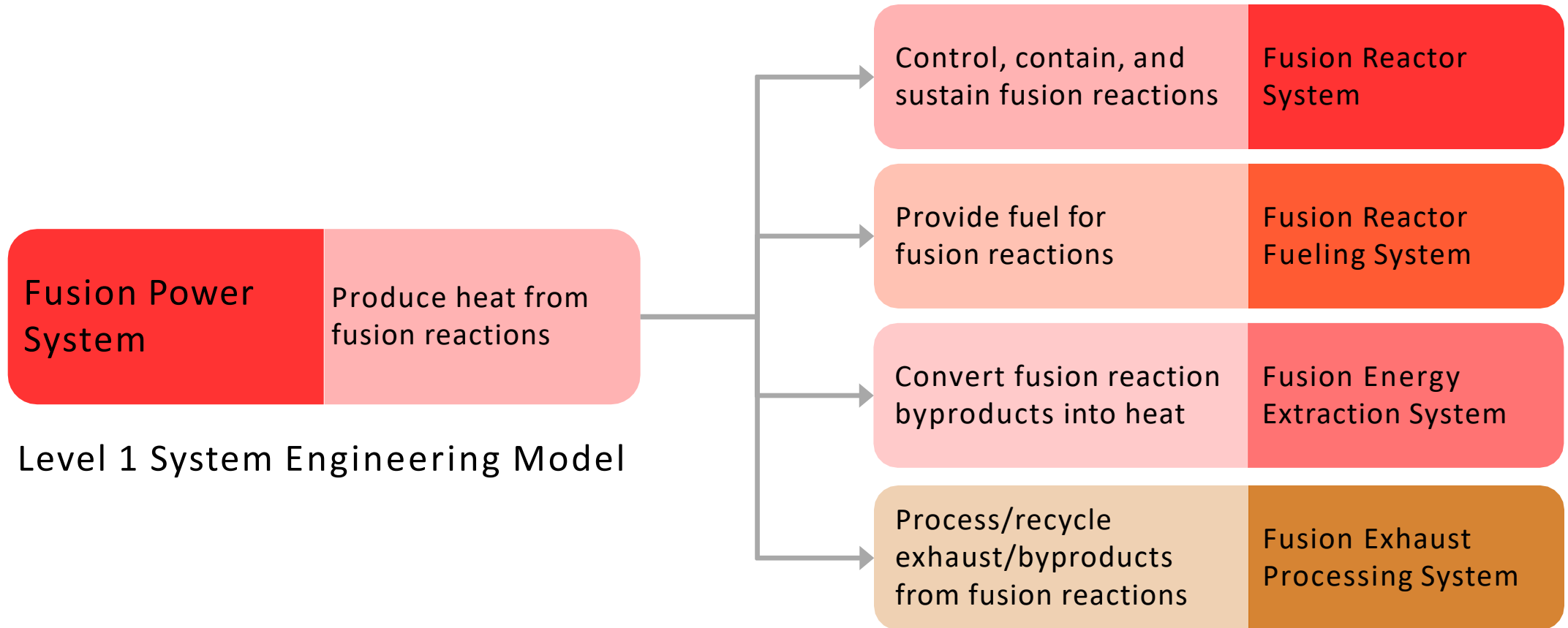

Level 1 System Engineering Model

Level 2 System Engineering Model



Definition of the Activity

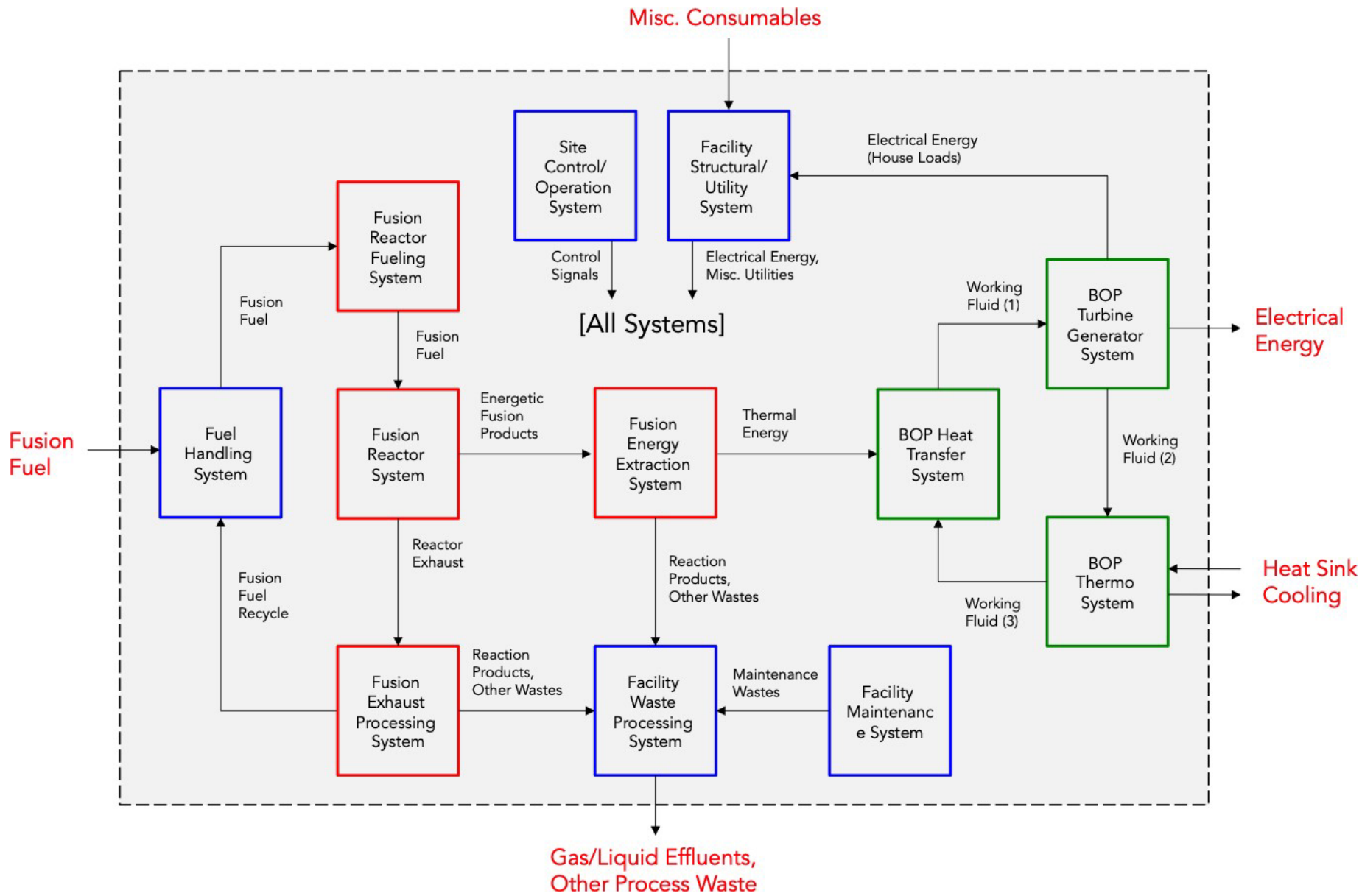

Model structure illustrates interactions of fusion systems and balance of plant systems

Level 2 System Engineering Model:
High Level System Functions and Interfaces

Third decomposition of functions approaches limit of form-independent characterization of fusion

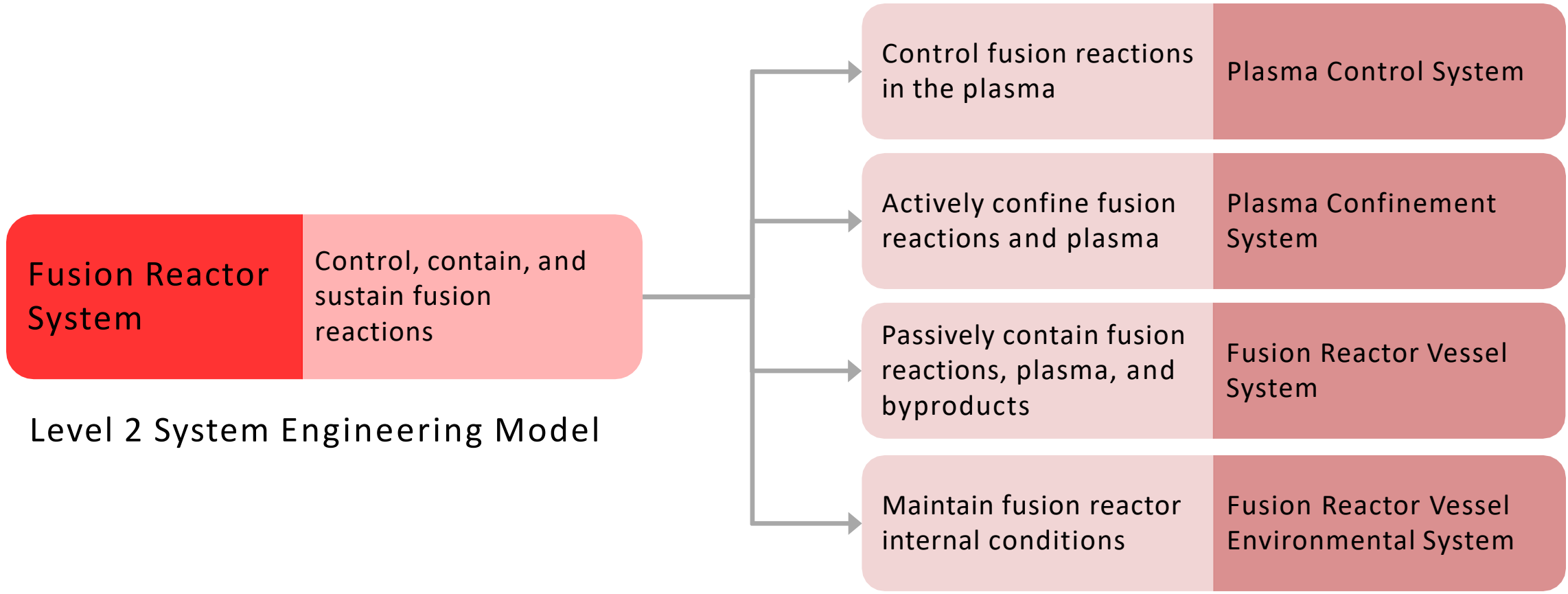

Level 2 System Engineering Model

Level 3 System Engineering Model



Definition of the Activity

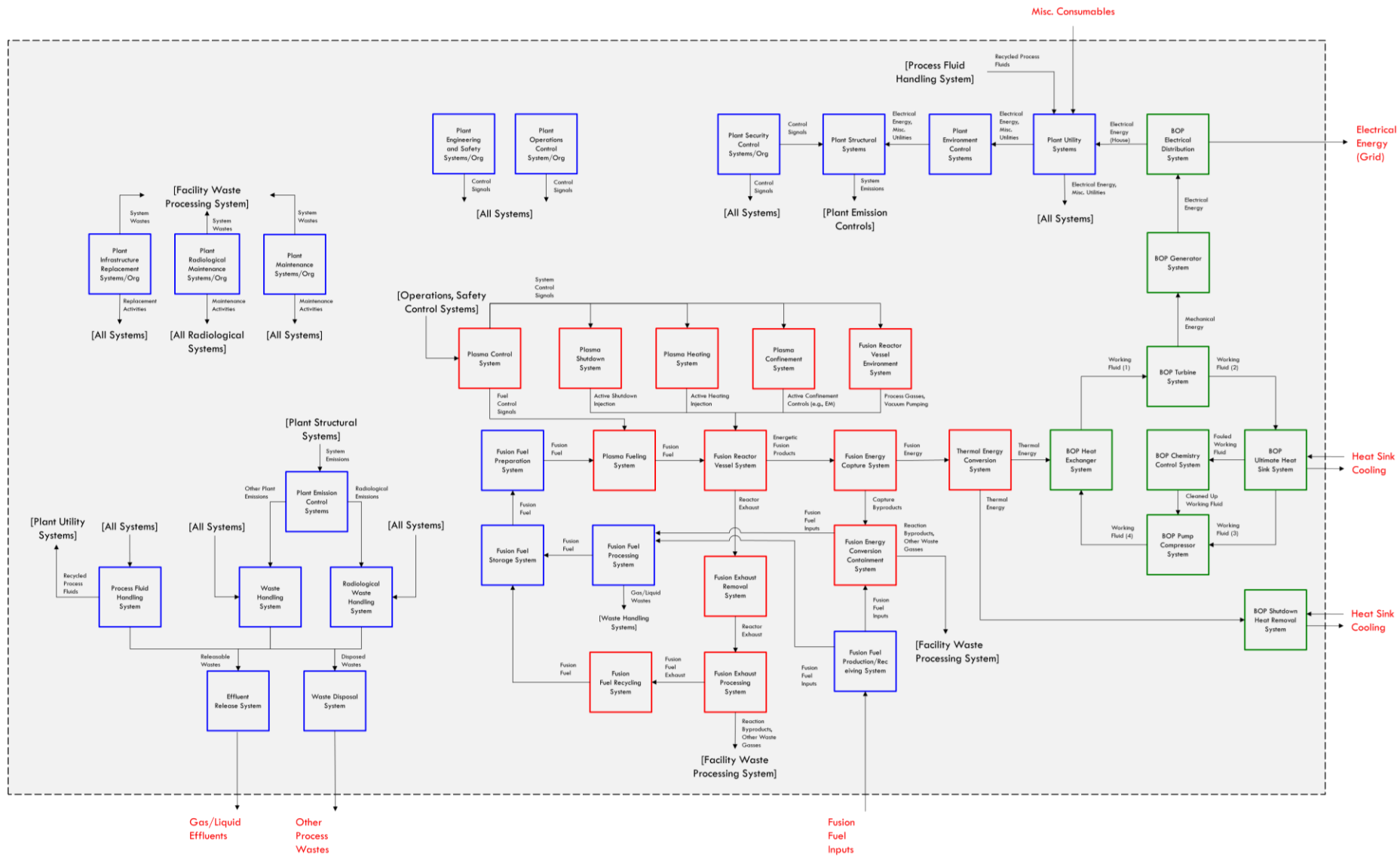

Level 3 System Engineering Model provides detail functional diagram for commercial fusion facility

Level 3 System Engineering Model:
Plant System or Component Functions and Interfaces



Definition of the Activity

Portion of system engineering model shows emergent detail and interactions within commercial fusion facilities

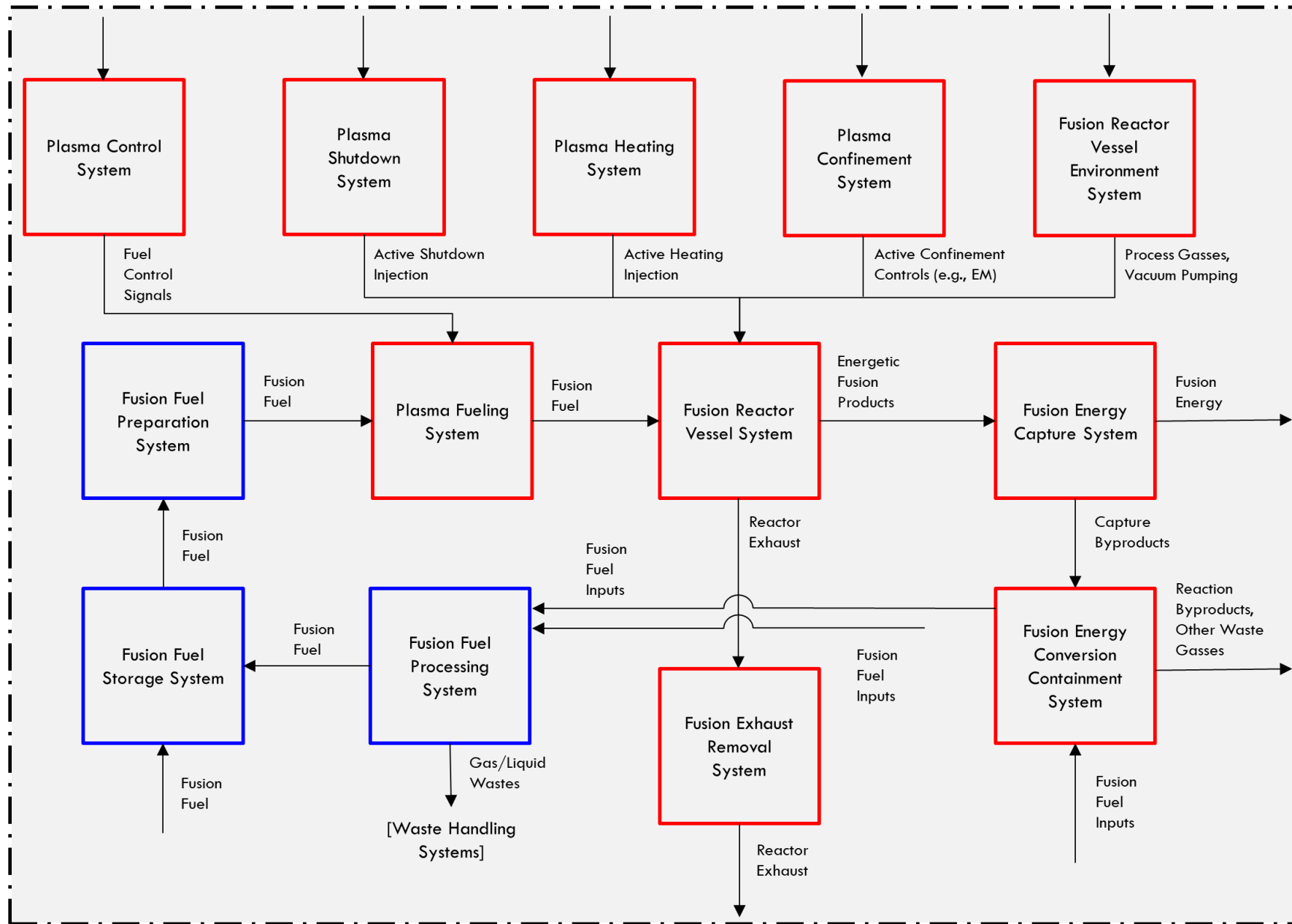

Portion of Level 3 System Engineering Model

Development of technology-specific models enables better characterization of fusion facility hazards

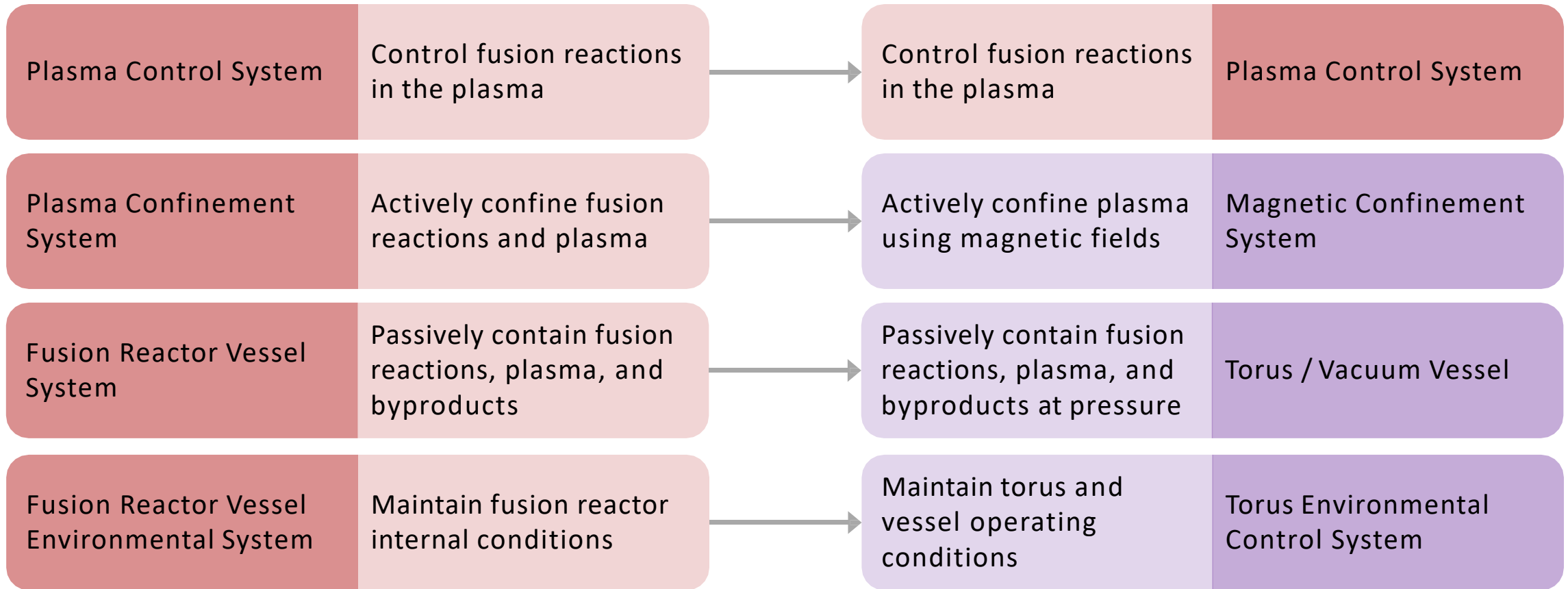

Level 3 System Engineering Model

D-T Tokamak Technology Specific Level 3 System Engineering Model



Definition of the Activity

Technology-specific model enables characterization of specific functional systems in fusion facility

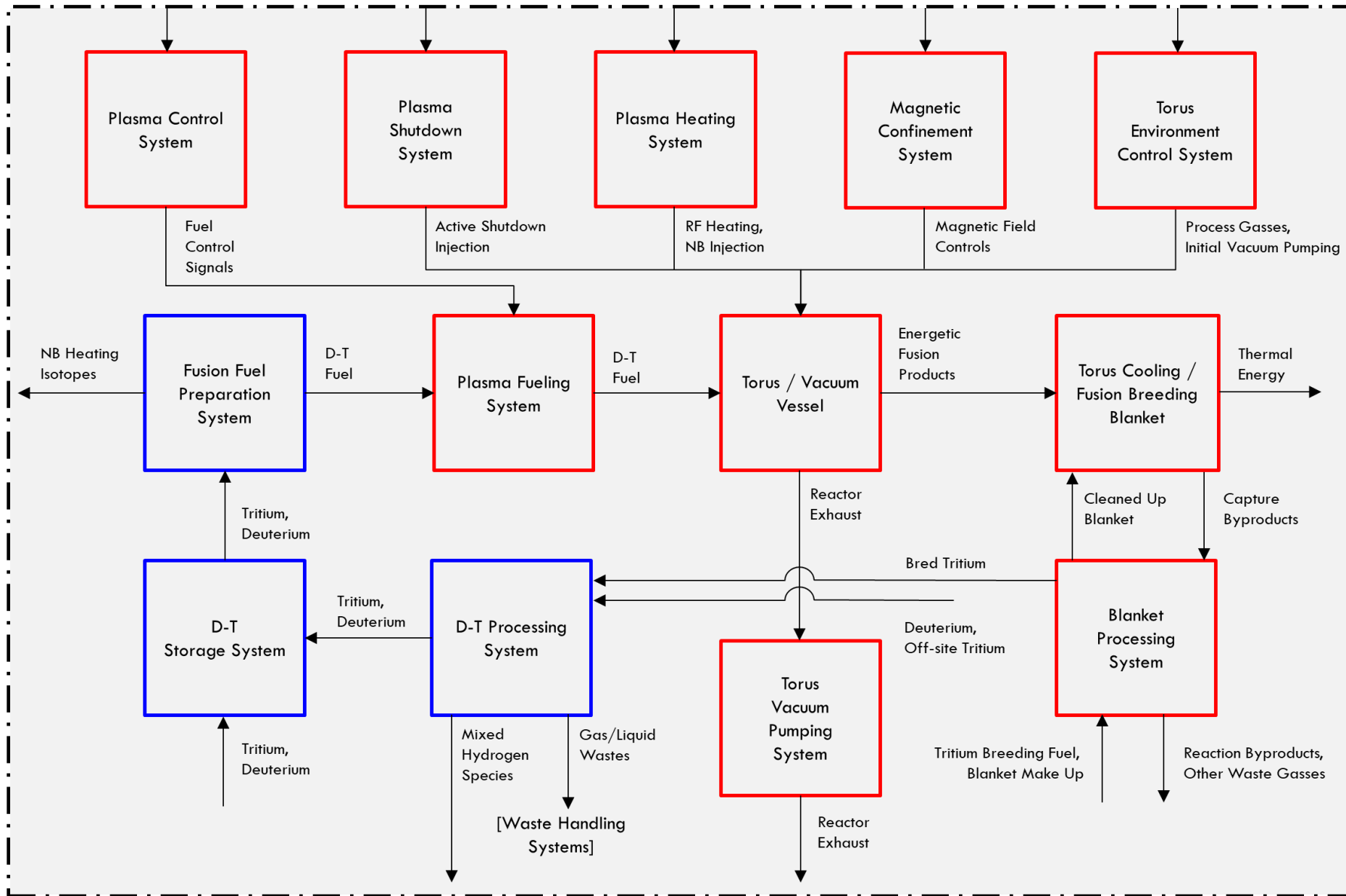

Portion of D-T Tokamak Level 3 System Engineering Model

System engineering, functional decomposition reveal relationships and characterization for fusion facility



Example:

Function Block	Function
Torus / Vacuum Vessel	Passively contain fusion reactions, plasma, and byproducts at pressure

Function Block Description

- Physical system that contains includes the torus and vacuum vessel that passively contain the plasma during operation
- Critical system interface between fusion fuel and plasma control related function blocks (inputs), and reactor exhaust and fusion energy capture related function blocks (outputs)

System engineering and functional decomposition facilitates design-independent facility characterization



System Engineering Model Levels

- Level 0 – Generalized Facility Concept Inputs and Outputs
- Level 1 – Generalized Plant Functions and Interfaces
- Level 2 – High-Level System Functions and Interfaces
- Level 3 – Plant System or Component Functions and Interfaces
- Level 3 – Technology-Specific Plant System or Components

Important Limitations

- Assumptions on electricity production
- Assumptions on thermodynamic cycle
- General example for technology-specific design

Broad hazard description facilitates robust characterization of possible fusion hazards



Hazard Identification Categories

- Electrical
- Thermal
- Pyrophoric Material
- Spontaneous Combustion
- Open Flame
- Flammables
- Combustibles
- Chemical Reactions
- Explosive Material
- Kinetic (Linear and Rotational)
- Potential (Pressure)
- Potential (Height/Mass)
- Internal Flooding Sources
- Physical
- Radioactive Material
- Other Hazardous Material
- Direct Radiation Exposures
- Non-ionizing Radiation
- Natural Phenomena
- Superconducting Magnets
- Criticality
- External Man-made Events
- Vehicles in Motion

Source: Adapted from Department of Energy (DOE) *Hazard and Accident Analysis Handbook*

Characterization of adverse consequence importance focuses evaluation on significant hazards

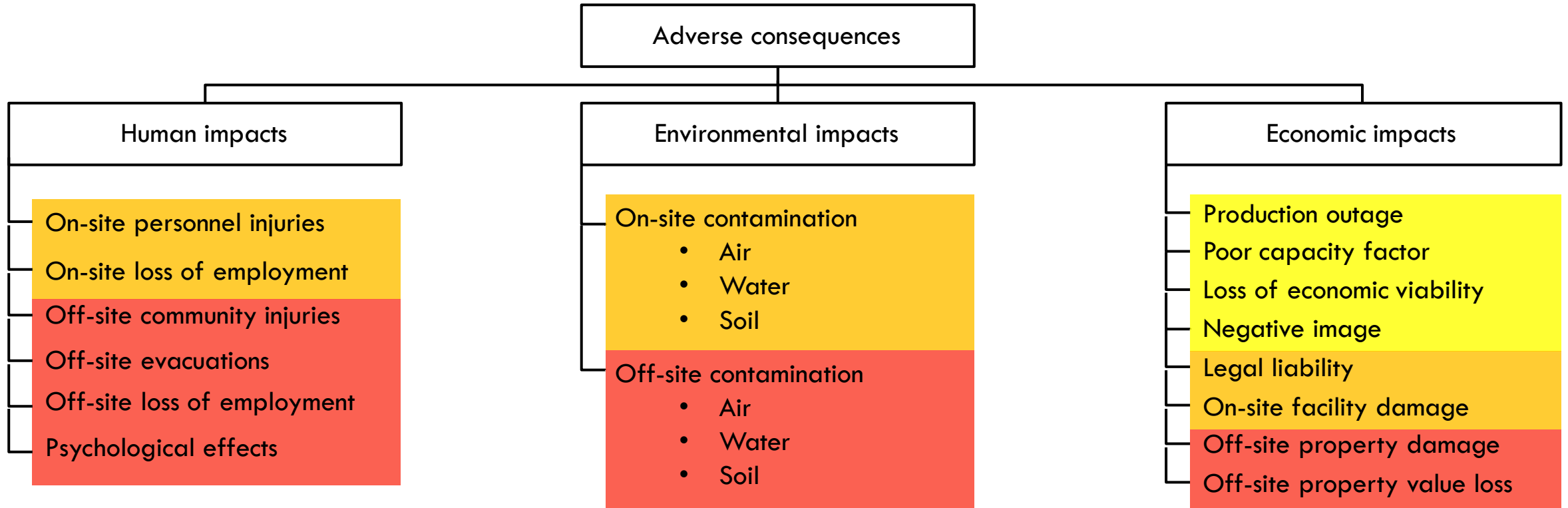

Source: Adapted from Department of Energy (DOE) *Guidelines for Hazard Evaluation Procedures*

Hazard Consequence Index (H_{CI}) provides a clear ranking system for hazard assessment of a novel system



Regulatory Significance

$$\text{Consequence Severity } (F_{CS}) \times \text{Regulatory Importance } (F_{RI}) = \text{Hazard Consequence Index } (H_{CI})$$

F_{CS}	Factor Criteria
3	High severity potential
2	Moderate severity potential
1	Low severity potential
0	No potential for consequence

F_{RI}	Factor Criteria
3	High regulatory importance (Off-site adverse consequences)
2	Medium regulatory importance (On-site adverse consequences)
1	Low regulatory importance or economic importance
0	No regulatory or economic importance

Example – Hazard Consequence Pairs

Direct Radiation Exposure (Hazard) and Off-site Evacuations (Consequence):

$$F_{RI} = 3 \text{ (High regulatory importance)}$$

$$F_{CS} = 1 \text{ (Low severity potential)}$$

$$H_{CI} = 3$$

Direct Radiation Exposure (Hazard) and Psychological effects (Consequence):

$$F_{RI} = 3 \text{ (High regulatory importance)}$$

$$F_{CS} = 3 \text{ (High severity potential)}$$

$$H_{CI} = 9$$

H_{CI} evaluation reveals 4 hazards with high severity potential and regulatory importance



Top significant regulatory hazards

- Radioactive Material
- Other Hazardous Material
- Explosive Material
- Direct Radiation Exposures

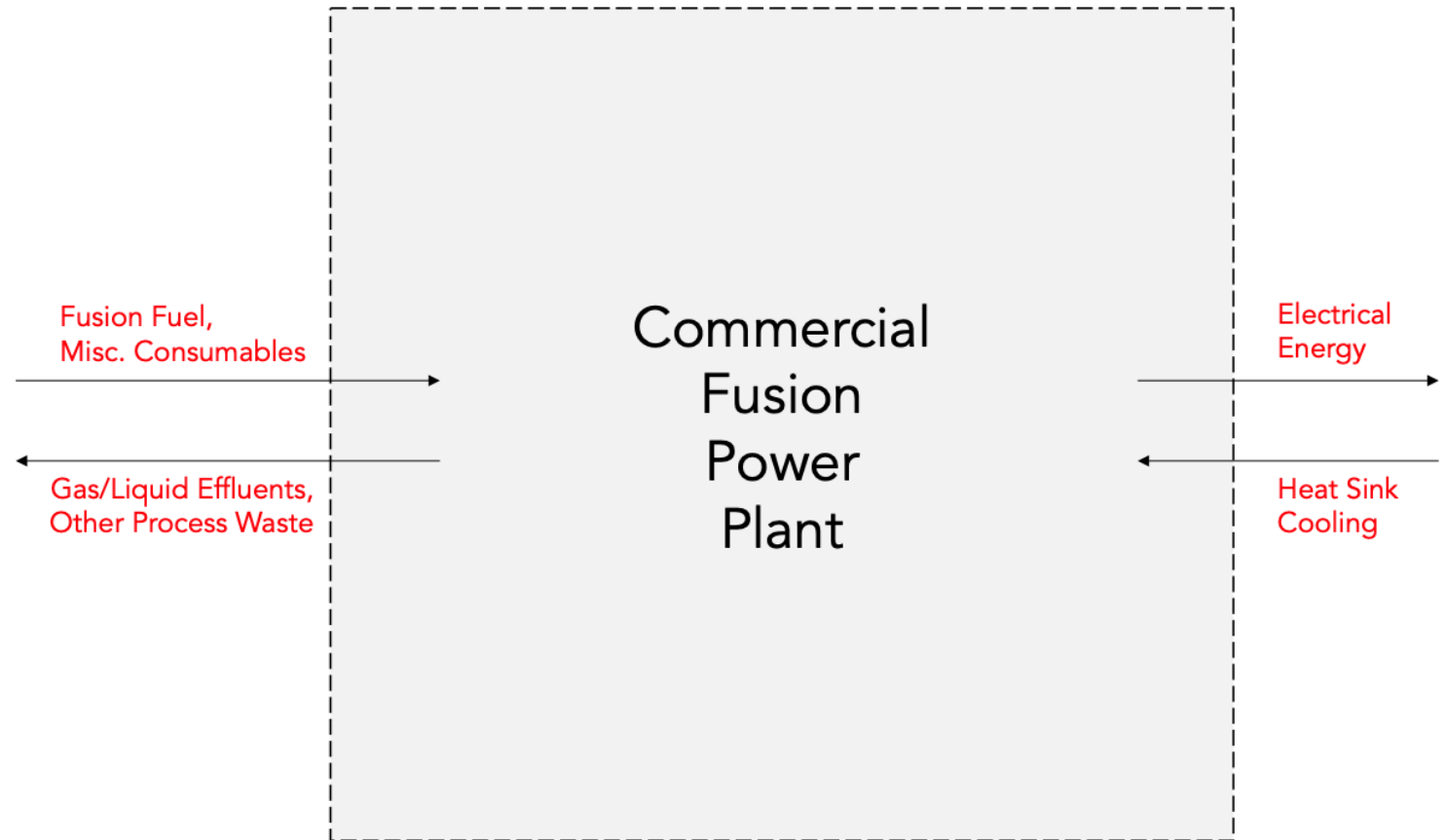

Example: Level 3 D-T Tokamak model highlights systems with regulatory significant hazards



Top significant regulatory hazards

- Radioactive Material
- Other Hazardous Material
- Explosive Material
- Direct Radiation Exposures



- Systems with 4 Hazards
- Systems with 3 Hazards
- Systems with 2 Hazards
- Systems with 1 Hazards
- Systems with 0 Hazards

Example: Level 3 D-T Tokamak systems with four regulatory significant hazards are wide ranging



Top significant regulatory hazards

- Radioactive Material
- Other Hazardous Material
- Explosive Material
- Direct Radiation Exposures

Fusion Power Systems

Torus / Vacuum Vessel

Plasma Fueling System

Plasma Heating System

Fusion Exhaust Processing System

Hydrogen Isotope Separation System

Torus Cooling, Fusion Breeding Blanket

Blanket Processing System

Torus Vacuum Pumping System

Process Fluid Handling System

Auxiliary Support Systems

Fusion Fuel Preparation System

D-T Processing System

D-T Storage System

Plant Radiological Maintenance

Radiological Waste Handling System

Plant Emission Control Systems

Effluent Release System

Waste Disposal System

Example: Radiological hazards can be broadly defined the D-T Tokamak Level 3 Model

Gases

- Activated air and process gases
- Activated plasma control gases
- Gaseous blanket/ structural activation products (e.g., C-14)
- Gaseous tritium and tritiated compounds

Liquids

- Liquid activation product (e.g., Be-10)
- Liquid aqueous radioactive products (H₂O with dissolved radioisotopes, HTO)

Plasmas

- Plasma radioactive products (activated control gasses)
- Plasma tritium

Solids

- Mobile solid activated materials (e.g., erosion/corrosion products)
- Mobile contaminated (including T) materials (e.g., erosion/corrosion products)
- Fixed solid activated materials (e.g., structural materials)
- Fixed solid contaminated (including T) materials (e.g., structural materials)
- Solid tritium metallic compounds (e.g., uranium titride, titanium titride)
- Solid frozen tritium compounds (e.g., T₂)

Example: Radiological hazards can be specified and defined for D-T Tokamak Level 3 Model block



Radioactive Material Hazards

- Activated plasma control gases
- Gaseous tritium and tritiated compounds
- Mobile solid activated materials (e.g., erosion/corrosion products)
- Mobile contaminated (including T) materials (e.g., erosion/corrosion products)

Function Block

Fusion Exhaust Processing System

Function

Separate unused fusion fuel from other fusion reactor waste streams

Completion of all steps for specific technology provides insights on potential hazards for commercial fusion

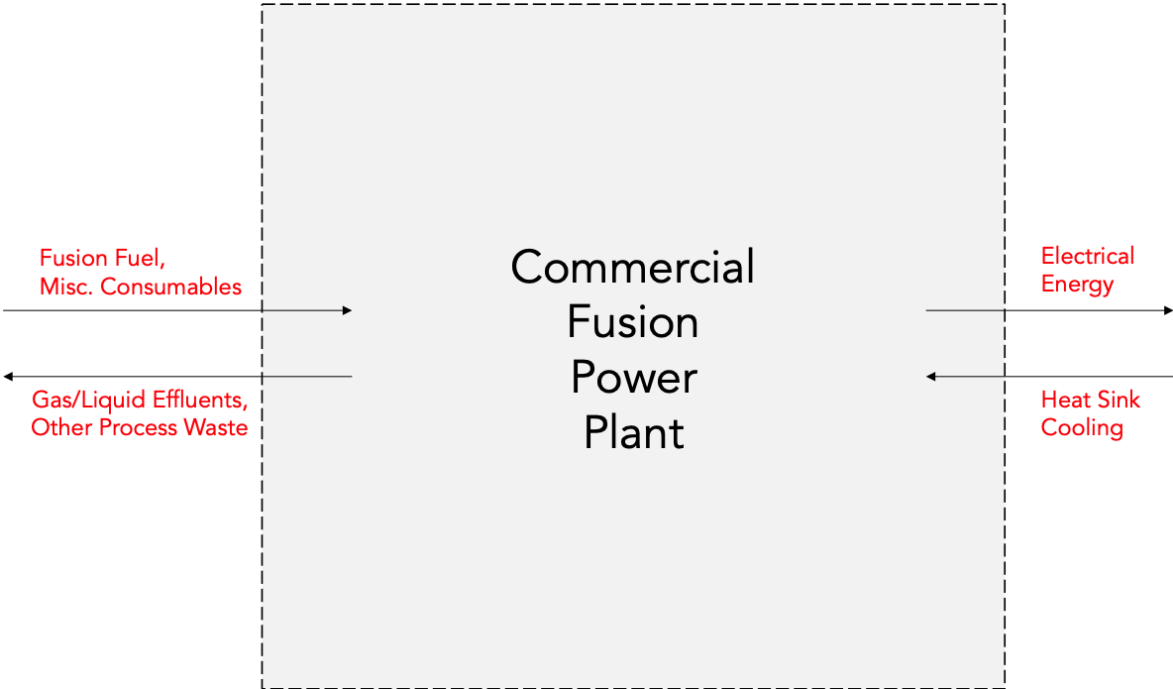

System Model Level

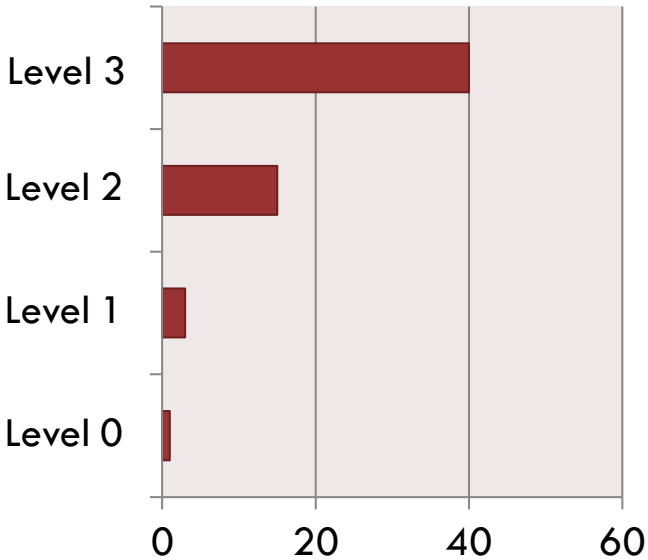

Increased engineering model complexity (# Systems)

Next step in regulation development is qualitative binning or technology-specific quantification of specific regulatory hazards

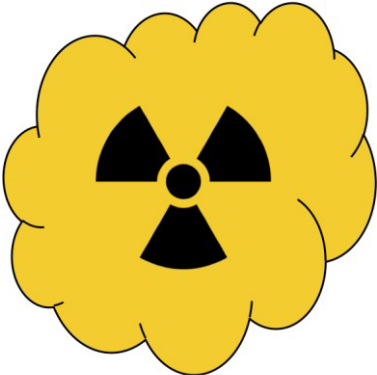

Hazard

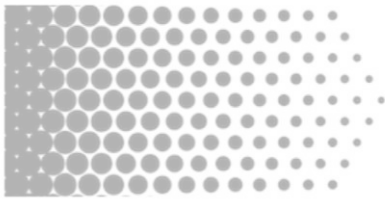

Exposure



Impact

Factors	Example
Hazard inventory	Total material or material vulnerable to release
Hazard inventory released	Fraction of material released
Hazard inventory release conditions	Time, location, form of the release

Factors	Example
Dispersion conditions	Meteorological, geographic, location factors that control dispersion
Exposure-dose conditions	Duration of exposure, physiological factors that affect total exposure

Factors	Example
Exposure-consequence relationships	Correlations between exposure and exposure consequences
Exposed population characteristics	Population distribution and characteristics that affect consequences

Applicant and regulator evaluation of hazards can result in a variety of insights but processes should be efficient and effective

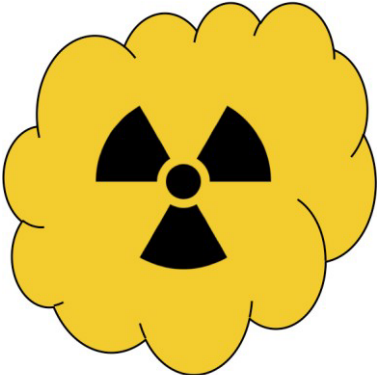

Hazard



Not applicable to technology or design

Applicable, quantified, and is not significant for safety or licensing evaluations

Applicable, qualitatively assessed and bounded, and is not significant for licensing evaluations

Applicable, quantified, and is significant for safety or licensing evaluations

Applicable, qualitatively assessed but not bounded, and is significant for safety or licensing evaluations

Applicability has not been determined or hazard has not been assessed - more information is needed.

Factors	Example
Hazard inventory	Total material or material vulnerable to release
Hazard inventory released	Fraction of material released
Hazard inventory release conditions	Time, location, form of the release

“First-principles” approach provides regulators and public repeatable and transparent framework for assessing fusion

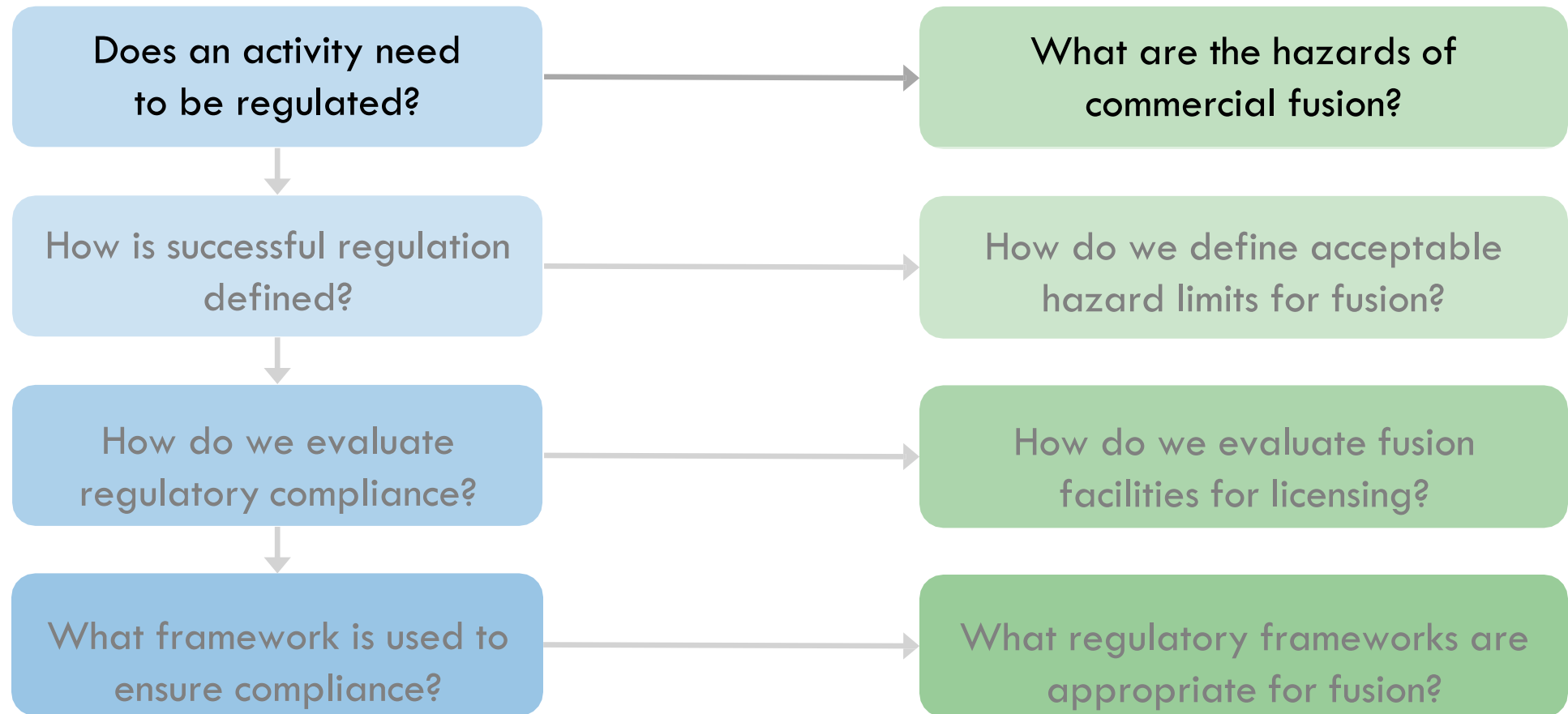

Future discussions can provide additional strategies and insights on “first-principles” approach to fusion regulation development

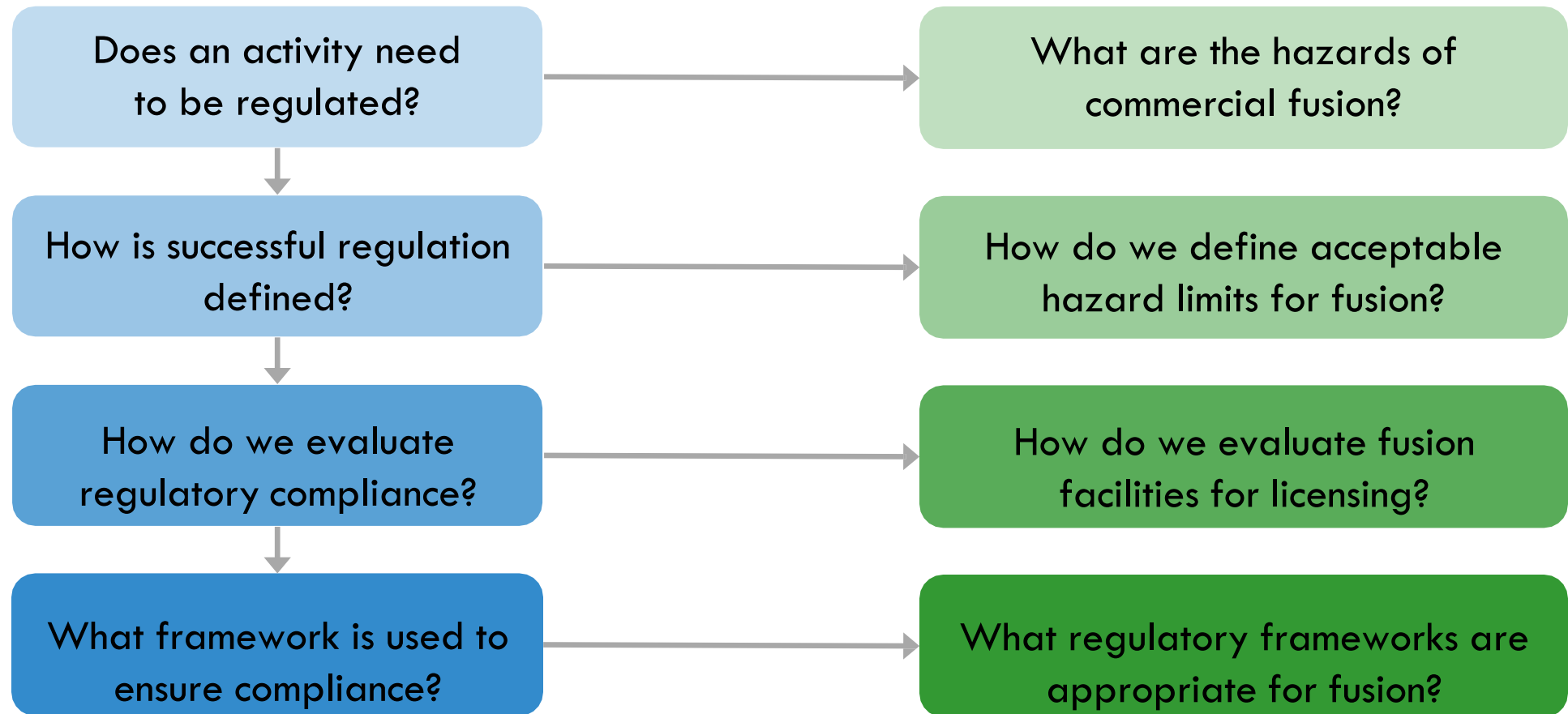

Process for identification of fusion hazards provides basis for regulatory discussions and reviews of commercial fusion facilities



System Engineering Models

- Technology-independent way to characterize fusion facilities
- Transparent and traceable process for regulators

Top significant regulatory hazards

- Radioactive Material
- Other Hazardous Material
- Explosive Material
- Direct Radiation Exposures

Not applicable to technology or design

Applicable, quantified, and is not significant for safety or licensing evaluations

Applicable, qualitatively assessed and bounded, and is not significant for licensing evaluations

Applicable, quantified, and is significant for safety or licensing evaluations

Applicable, qualitatively assessed but not bounded, and is significant for safety or licensing evaluations

Applicability has not been determined or hazard has not been assessed - more information is needed.

Agenda

Time	Topic	Speaker
1:00 pm	Introductions	NRC
1:15 pm	Identification and Characterization of Fusion Hazards	Dr. Patrick White
2:15 pm	Overview of Fusion Industry Association Member Company Commercial Device Operational & Off-Normal Safety Case	Andrew Holland, Fusion Industry Association & Derek Sutherland, CT Fusion
3:30 pm	Break	
3:40 pm	Overview of Tritium Handling Systems	Tyler Ellis, Commonwealth Fusion Systems
4:25 pm	Supplemental Discussion of the Helion Device Safety Case	David Kirtley, Helion Energy
4:55 pm	Question and Answer Period	
5:30 pm	Adjourn	



FUSION INDUSTRY ASSOCIATION

The Voice
of a new
Industry

The Fusion Industry Association is an international coalition of companies working to electrify the world with fusion - the unparalleled power of the stars. Energy from fusion will provide clean power for everyone that's safe, affordable, and limitless.

Offsite Impacts of Fusion

Normal Operation / Off-Normal Shutoff

NRC Public Meeting

March 23, 2022

FIA Membership

FUSION
INDUSTRY
ASSOCIATION



Commonwealth
Fusion Systems

generalfusion®

tae TECHNOLOGIES



first light

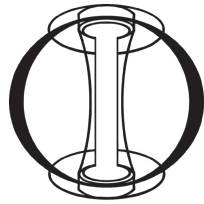

tokamak
energy

a faster way to fusion



ZAP ENERGY



HELION



HB11
ENERGY
LASER BORON FUSION



AVALANCHE

LPP FUSION

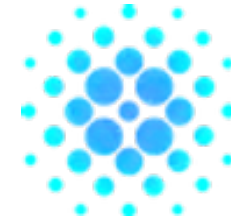

FOCUSED
ENERGY

MIFTi

SHINE™



ALBOT

MarvelFusion

CTFusion

As Brilliant as the Sun

fuse



RENAISSANCE
FUSION



HelicitySpace

HYPERJET
FUSION CORP



Helical Fusion

HORNE
TECHNOLOGIES

NK

Princeton
SATELLITE
SYSTEMS

nearstar
FUSION



EX-Fusion

Outline

Andrew Holland, CEO, Fusion Industry Association

- **FIA Survey Overview**

Derek Sutherland, CEO, CTFusion

- **Normal Operation of Fusion Energy Systems**
- **Off-Normal Shutoff of Fusion Energy Systems**

- **Summary, Questions**

FIA Survey Overview

FIA Survey Overview

Survey questions focused on three primary areas:

- **Fusion neutron shielding, and site boundaries**
 - What level and type of shielding will be used?
 - What is the current anticipated distance to site boundary for a planned commercial facility?
- **Tritium usage (if any)**
 - How much tritium is in the device at any one time?
 - How much tritium is in the vacuum chamber at any time?
- **Dust generation**
 - What activated dust may accrue in vacuum?
 - How much will be removed during regular cleanout?

FIA Survey Overview

- Data collected from members during January 2022
- All U.S. FIA members with well-developed technological designs provided responses
- These numbers were compiled and used to calculate the offsite impacts of commercial fusion technology
 - Calculations and scenarios focused on highest potential impact
 - Only considered safety systems which are universal to all commercial fusion developers

FIA Survey Overview - General Impressions

There is no “generic” fusion power plant, but some common features

- FIA members vary greatly in anticipated size, ranging from small devices aiming for 1 kWe power production up to 350 MWe.
- FIA members also vary in fusion technology approach (magnetic, inertial, magneto-inertial) and fuel type (D-T, D-D, D-³He, p-¹¹B)
- HOWEVER, there are no plans in the FIA for anything in the GWe sizes being predicted by international DEMO designs.
 - None will require active cooling after shutdown
 - The designs, fuel sources, first walls materials, and shielding anticipated in fusion power plants varies as well, but commercial fusion facilities share some common features.
 - From a risk-informed perspective, all of the conceived fusion reaction types or fuel choices present risks that can be appropriately regulated under Part 30 regulations

Moving on an Accelerated Timeline

There is a common development timeline
FIA Members are moving into fusion pilot
plants by the late 2020s

- FIA members are moving at an accelerated rate, relevant to the White House's "[Bold Decadal Vision to Accelerate Fusion Energy](#)" announced at a summit on March 17.
- FIA members anticipate applying for a commercial operation license as early as 2026, with more coming 2027-2030

7. WHEN WILL FUSION FIRST POWER THE GRID SOMEWHERE IN THE WORLD?

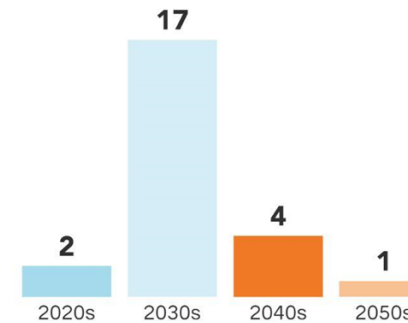

8. WHEN WILL FUSION FIRST BE USED FOR SPACE PROPULSION?

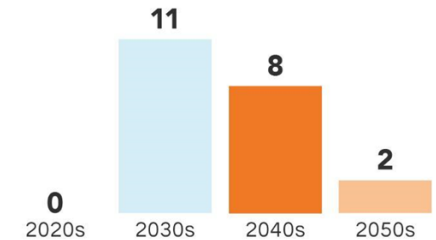

#FusionIndustry2021

©FIA/UKAEA The Global Fusion Industry in 2021

FIA Survey Results

Fusion neutron shielding, and site boundaries

For most fusion power plants, the *neutrons are the energy output*, so capturing these neutrons are an economic imperative. For those not captured, shielding will protect workers and the general public

Q: What shielding will be used to minimize offsite exposure and worker dose?

The need for shielding depends on several factors beyond just neutron flux, especially the design of the blanket.

A: Liquid metal or molten salt blanket, concrete shield, boron carbide, polyethylene, water, graphite, metal hydrides, tungsten

Q: What is the anticipated site boundary distance?

A: Site boundaries have generally not been determined, and will depend on the shielding implemented. It is possible that site boundaries would be determined by standard industrial offsets like those at similarly-sized gas turbine generators.

Q: What is the anticipated fenceline dose?

A: All are targeting a fenceline dose of very close to zero, well below the 10 CFR Part 20 limits.

FIA Survey Results

Tritium usage

Q: How much tritium is in the commercial fusion power plant at any one time?

A: 0 - 90 g

Q: How much tritium is in the fusion vacuum chamber at any time?

A: 0 - 0.1 g

**Note that this does not account for the amount of tritium that may be stored on site, but in a facility separate from the power plant. These facilities would already be regulated under existing 10 CFR Part 30 or relevant agreement state materials regulations.*

FIA Survey Results

Dust generation

Q: What are the isotopes of activated dust that may accrue in the vacuum?

Dust is relevant to fusion power plants that have solid walls, and the types of dust that may accumulate are dependent on the material choice for the walls. Since new first wall-materials will likely be developed for use in commercial fusion systems, these calculations will change as new alloys are developed.

A: Isotopes vary design-by-design and are driven by materials choices. Representative isotopes in fusion power plants include: O, Si, Hf-178m, Ta-179, Ta-182, W-181, W-183, W-185, W-187, Re-186, Re-187, Re-188

Other aneutronic fuels will have different portfolio of activated materials in trace amounts.

Q: What is the maximum amount of dust that can accumulate prior to a scheduled outage for cleanout?

This question is dependent upon reactor size, operation, materials, scenarios, and many other variables and is difficult to normalize.

A: Most companies have not yet done the calculations, and the answer will be determined by operational needs, but estimates are well below 100g.

Normal Operation of Fusion Energy Systems

All fusion systems consume light elements and produce slightly heavier ones, releasing usable energy in the process

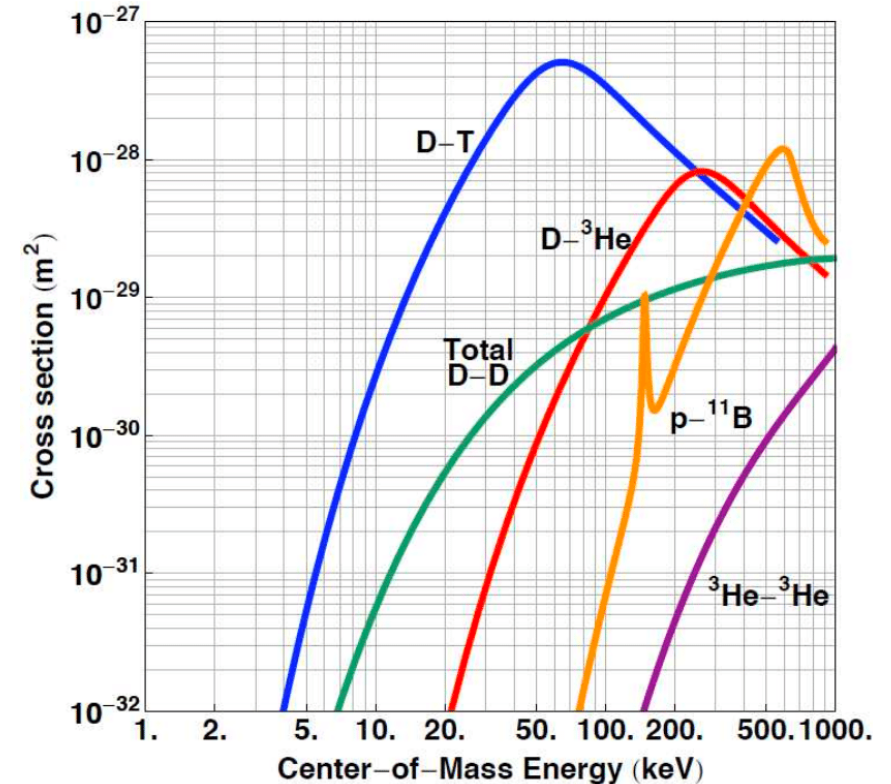
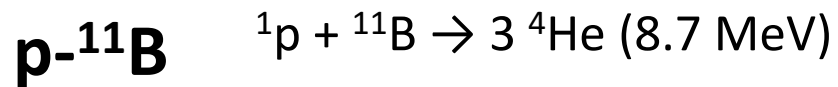
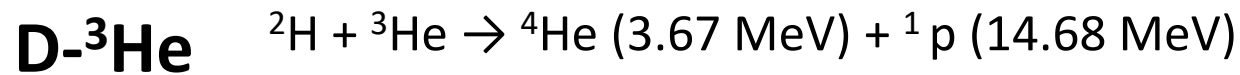
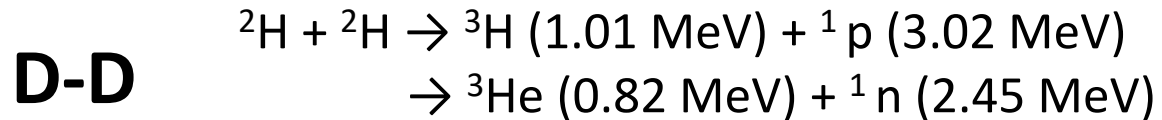
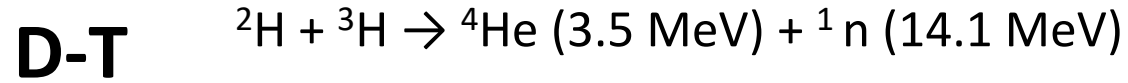

Zero usage of special nuclear materials (i.e. uranium, plutonium) in fusion energy systems and requires high temperatures for relevant reaction rates

Energy accounting defines requirements for net-gain operation, “burning” and “ignited” fusion plasmas

Conservation of Energy: Energy cannot be created or destroyed, so sources of energy must equal losses of energy from a system for the energy content to stay the same.

Sources of Energy = Losses of Energy

$$P_{\text{fusion}} + P_{\text{input}} = P_{\text{light}} + P_{\text{cond.}}$$

Sources of energy

P_{fusion} is the fusion power density in the fusing plasma

P_{input} is the external heating power supplied to the plasma

Losses of energy

P_{light} is the loss of energy from the plasma as light (i.e. Bremsstrahlung light)

P_{cond} is the loss of energy from the plasma as heat (i.e. thermal conduction $3nT/\tau_E$)

Net-gain operation is required for all commercial fusion energy systems, “burning” plasmas are plasmas with self-heating at least equal to input power

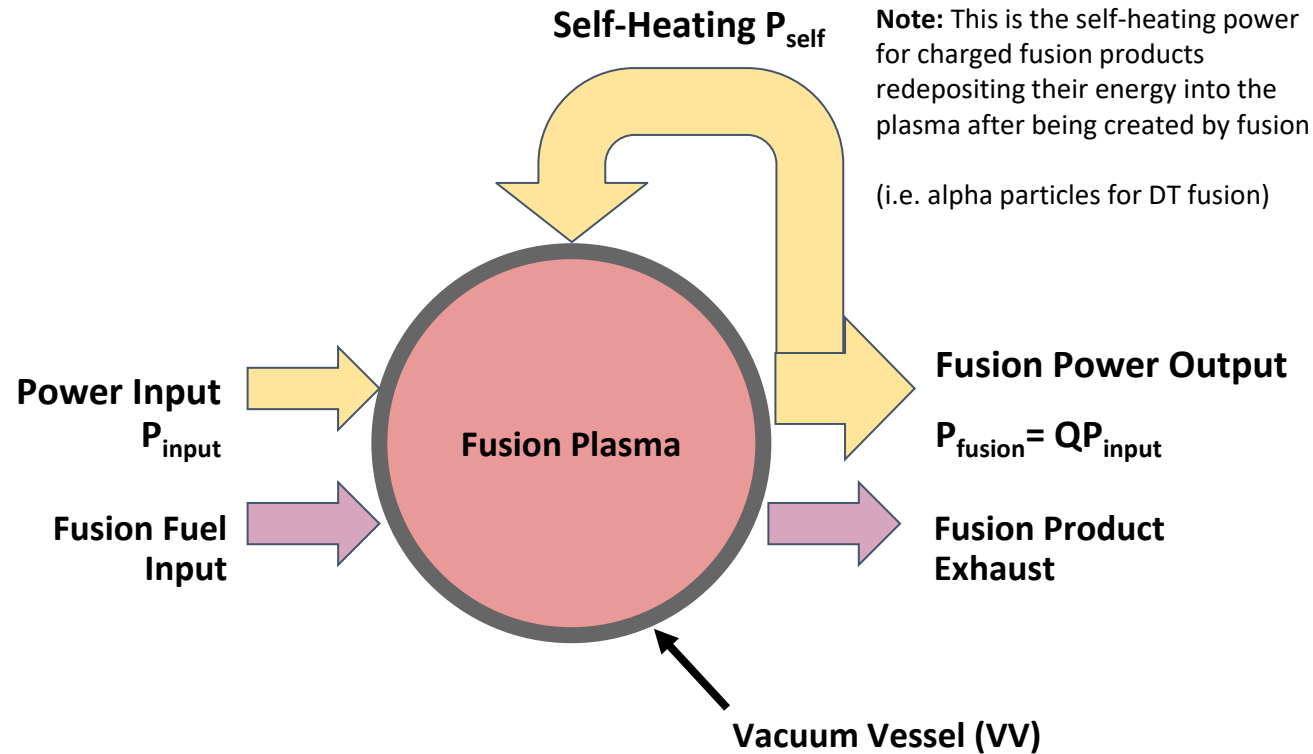

Fusion Power

$$P_{fusion} \cong n^2 \langle \sigma v \rangle E_{rec} V$$

n is plasma density, $\langle \sigma v \rangle$ is fusion reaction rate, E_{rec} is the fusion energy released per reaction, and V is the fusing plasma volume

Sub-ignited, Net-gain Operation

$$\infty > Q > 1, P_{input} > 0$$

“Burning DT Plasma” Operation

$$\infty > Q \geq (5P_{self}/P_{input}) \geq 5$$

$$P_{self}/P_{input} \geq 1$$

“Net-Gain”: making more fusion power/energy (P_{fusion}) than the input power/energy (P_{input}) required to make it happen – $Q = P_{fusion}/P_{input} > 1$

New fusion fuel must be added and fusion products removed to maintain $P_{fusion} > 0$, **otherwise fusion power shuts off**

All fusion approaches can only fuse a small amount of fusion fuel in the plasma at any time, **otherwise fusion power shuts off**

Ignited fusion plasmas are the special case when enough self-heating power P_{self} is made to balance losses, but does not change fusion physics safety

Ignited Operation: $Q = P_{fusion}/P_{input} = \infty$ because $P_{input} = 0$ (not $P_{fusion} = \infty$)

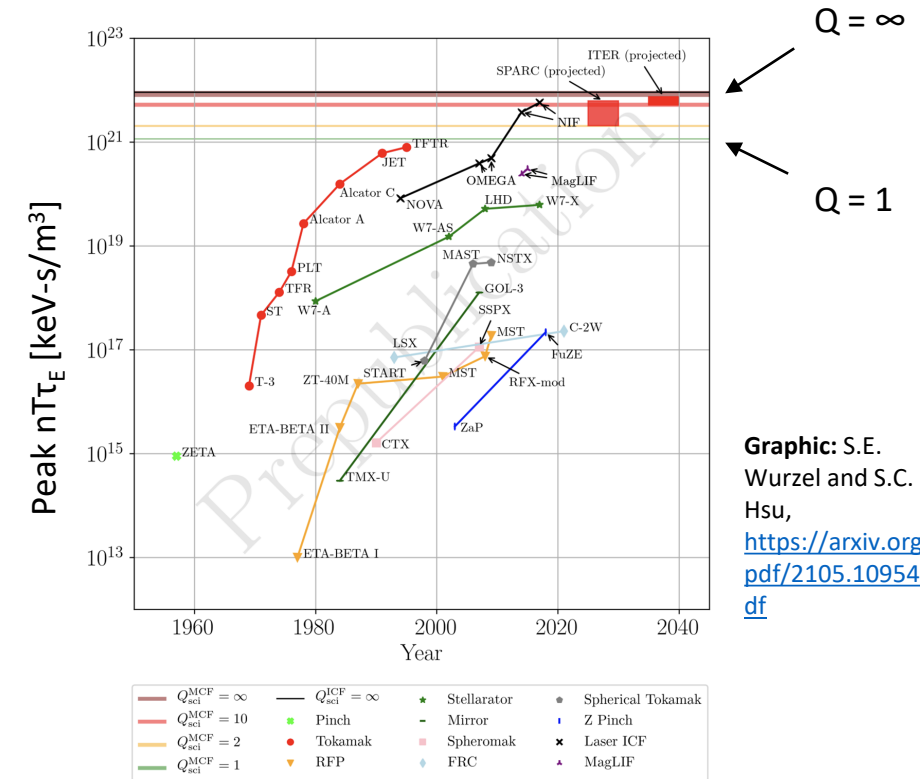
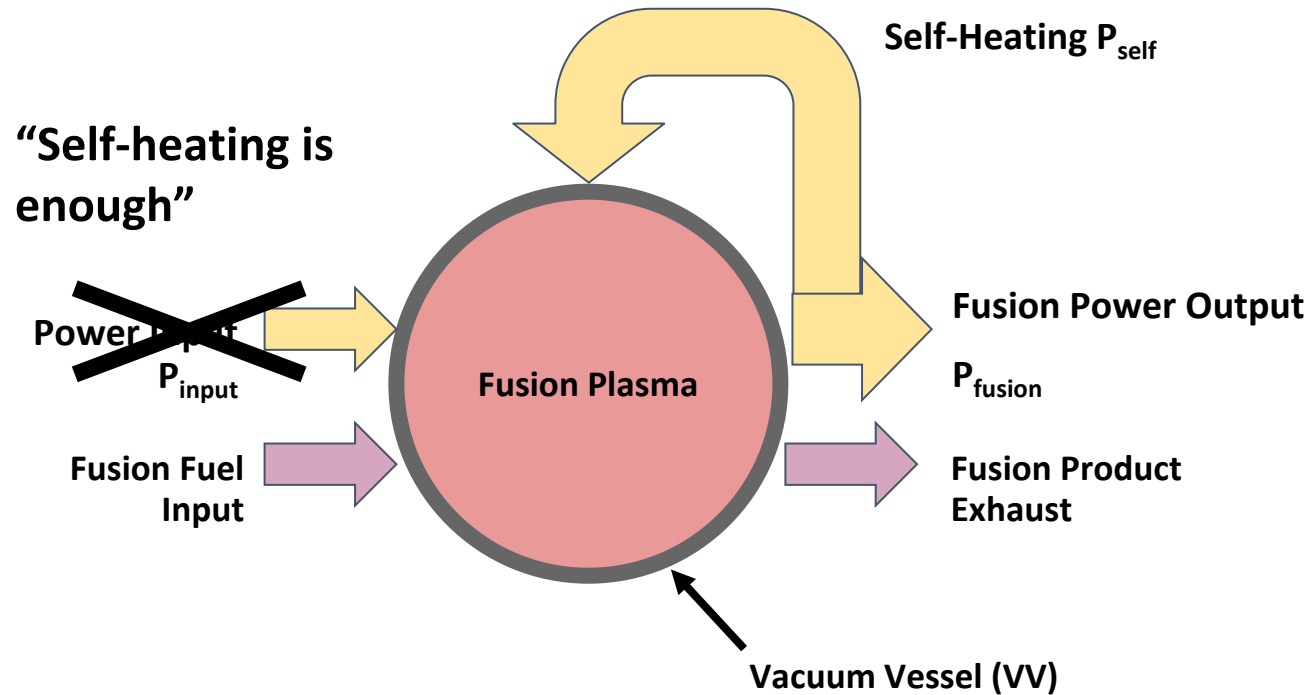

Graphic: S.E. Wurzel and S.C. Hsu, <https://arxiv.org/pdf/2105.10954.pdf>

No external input power is required to keep the system running in ignition, but fuel input, exhaust, and fusion physics is the same as sub-ignited operation and does not enable a nuclear chain reaction

Most fusion concepts plan for sub-ignited, net-gain $\infty > Q > 1$ commercial fusion systems

Fusion fuel inventory in all fusion systems at any time is very small, and cannot be arbitrarily increased without system shutting off

Fusion Systems

(Requires high plasma temperatures)

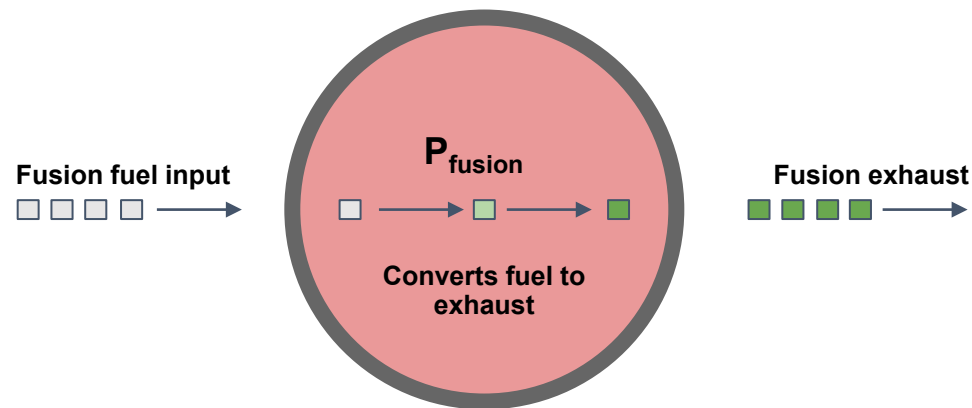

Fusion systems have small fuel inventories, and high throughput demanding constant fuel input and exhaust for system to not shut off.

Suddenly introduction too much fusion fuel causes the system to shut off because of rapid plasma cooling

Fusion fuel is converted into exhaust (i.e. helium) and is **not** a nuclear chain reaction (the concept of criticality **does not** apply).

Fission Systems

(Can run at room temperature)

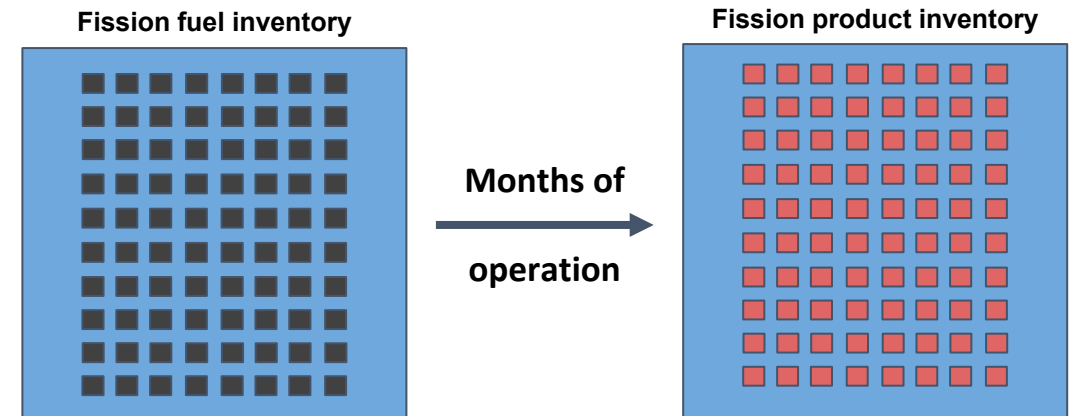

Fission systems have high fuel inventories and are low throughput. All fuel needed for total energy release for months of operation is present at start.

Slow release of fission energy over time is required for safe operation.

Fission fuel is converted into fission products by a nuclear chain reaction (the concept of criticality **does** apply).

Blankets and Shielding Mitigates Offsite Radiation From Fusion Energy Production

- Key contributor to potential offsite impact is radiation leaving the device: *neutrons and gamma rays*
- Neutron and gamma ray doses are well mitigated by both blanket and shielding
- Multiple levels of shielding would be used:
 - Self-shielding: The fusion device itself and ancillary systems, such as the blanket, would absorb most neutrons
 - Additional shielding: Remaining neutrons and gammas would be shielded using other common materials (e.g., metal hydrides, concrete, etc.)
- Required shielding design and levels is determined in a similar manner to other technologies licensed under a materials-framework (e.g., accelerators)

* **Note:** Blankets are used to slow down DT neutrons to make heat and contain lithium to make tritium for fuel on-site. Systems that use other fusion fuel cycles (D-³He and p-¹¹B) will have different design requirements.

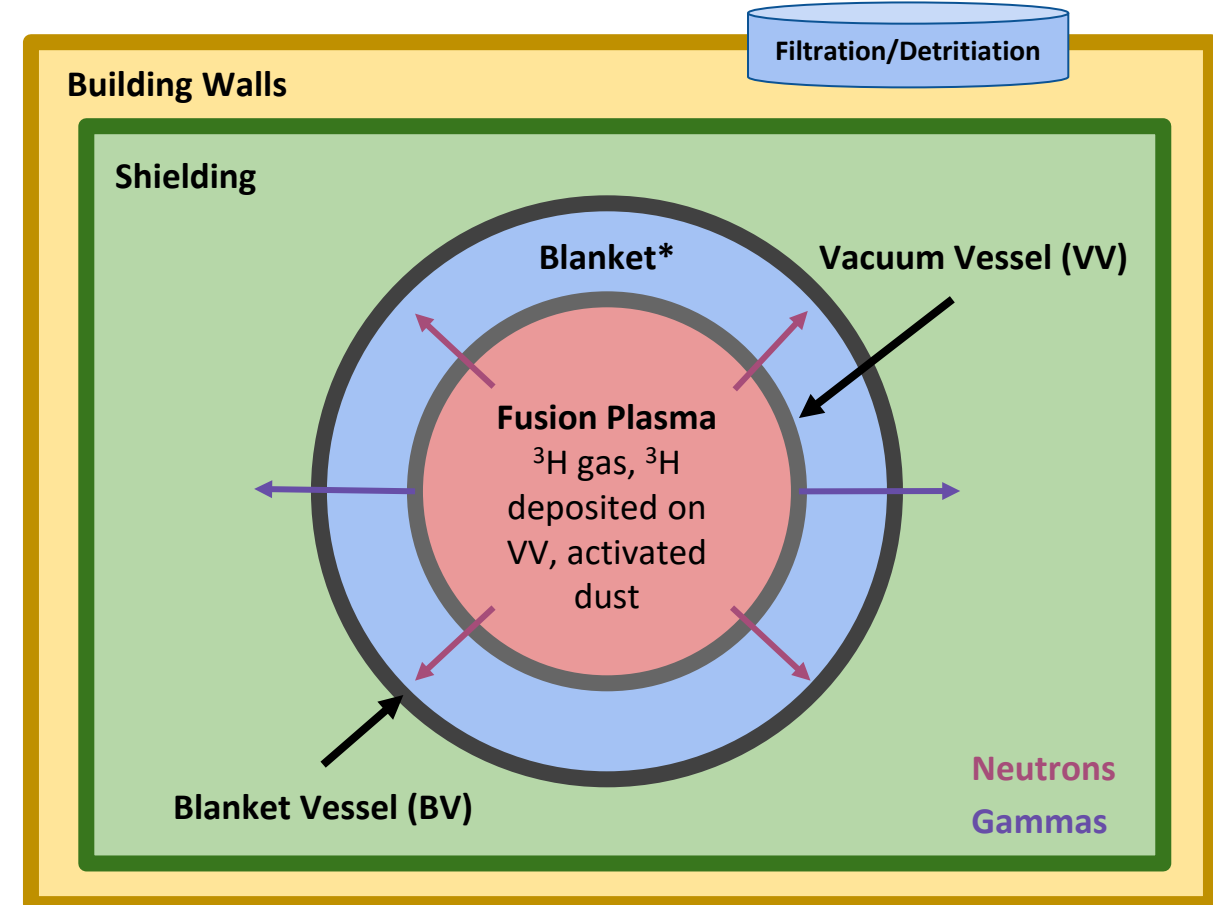

Description. Dose due to fusion neutrons and gammas, which are mitigated by the use of blankets and/or shielding

Offsite Impact. << 10 mrem/year during normal operations

Metal hydrides are exceptional fast neutron and gamma shields

A combination of high-Z (for gamma) and low-Z (for neutron) shielding is most efficient

Water (H₂O) is also very good for neutron shielding because it is composed of light elements (low-Z)

Concrete also is very effective at shielding both neutron and gamma emissions

Effective and already in-use shielding solutions are available to mitigate impacts of neutron and gamma emissions from fusion systems

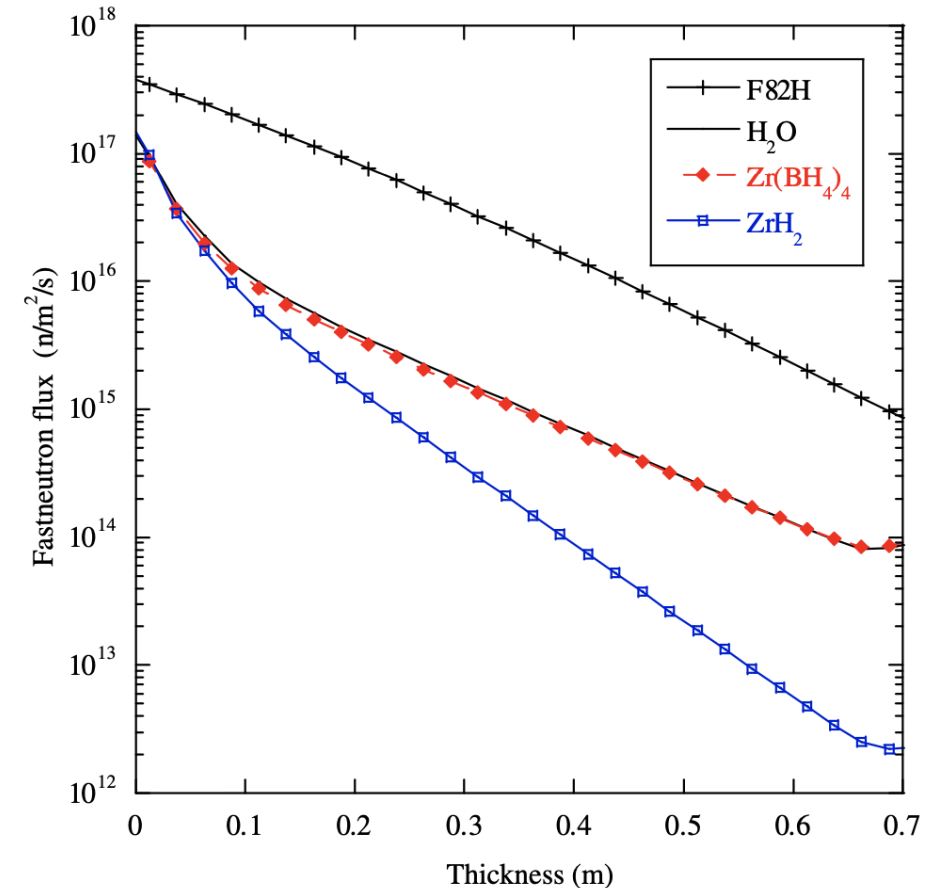

Graphic: T. Hayashi, Joul. Nucl. Mat. 386-388 (2009), 119-121, <https://doi.org/10.1016/j.jnucmat.2008.12.073>

Concrete is another example of highly effective neutron and gamma shielding

- Calculation to right uses an anticipated neutron production rate from a commercial fusion device
- As shown, simple concrete shielding can reduce the dose to well-below regulatory limits
- This calculation does not consider any self-shielding, such as from a blanket system that will capture the majority of neutrons.

Calculation using MCNP6.2

- Isotropic neutrons in a 1-cm spherical source
- Neutrons are 14.1 MeV (from DT fusion) at 10^{18} neutron/sec
- 5-m-radius sphere of concrete as an example
- Existing accelerator and medical systems use 2-5 m concrete shielding
- Calculation of both neutron and gamma (secondary) dose

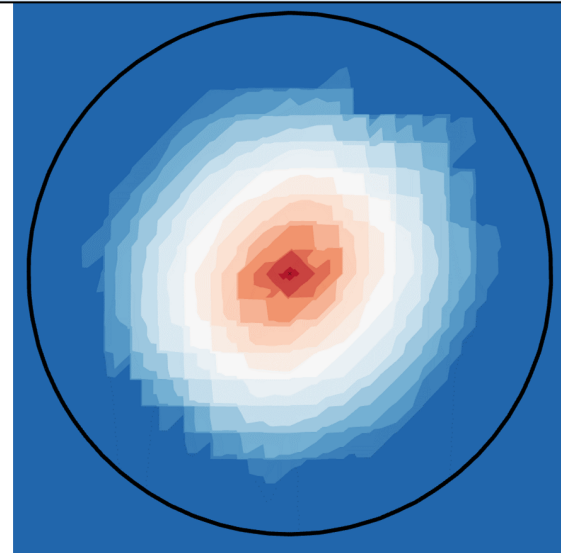

neutron

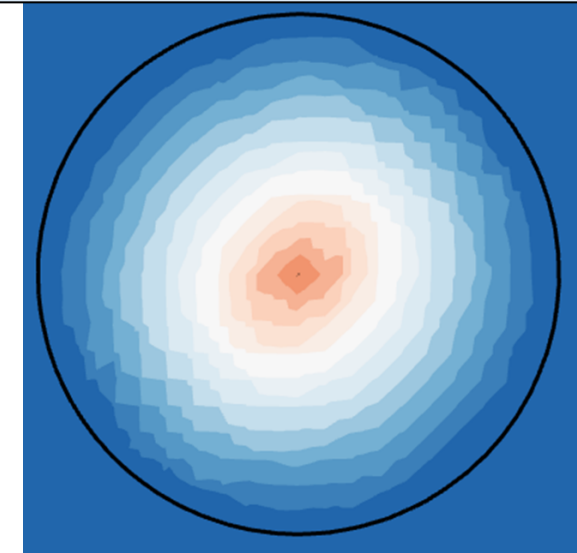

photon

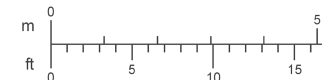

Dose
[rem/hr]

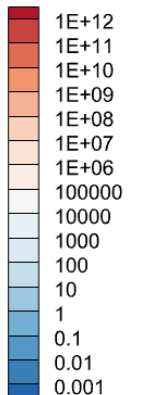

Activated dust generation from fusion operations

- Neutron activation of solid VV materials and plasma/fusion product interactions with the solid VV during normal operations can generate dust
- Dust is routinely removed during maintenance cycles, but can be released from VV during particular off-normal shutdown events to be considered in this presentation
- Activated dust quantities and composition are largely driven by material choices and fusion system specifics

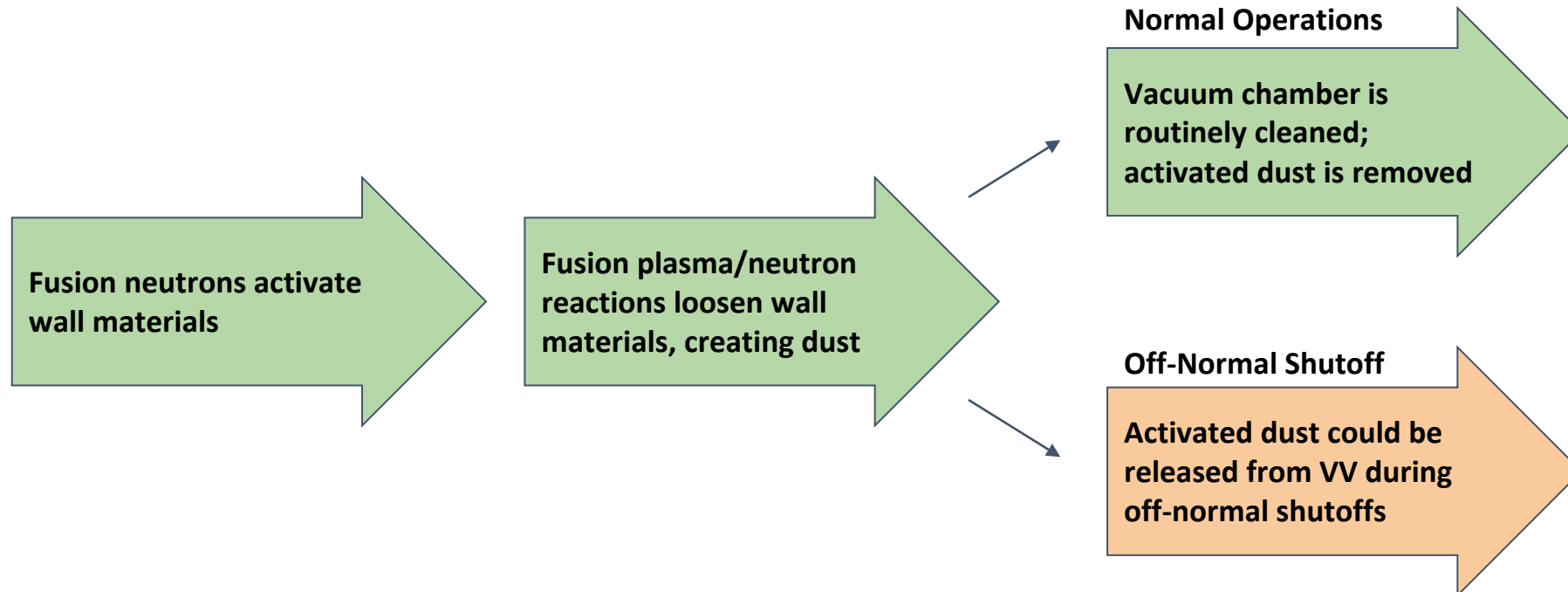

Off-Normal Shutoff analysis to follow will focus on tritium usage and activated dust within the vacuum vessel

- Tritium can be present in the plasma dependent on the fusion fuel cycle of choice
- Tritium can be deposited on the wall, which is typically the majority of the tritium within the vacuum vessel
- All off-normal events considered assume a full puncture of the vacuum vessel such that it is open to air within the building
- A puncture of a vacuum vessel immediately halts all fusion reactions and corresponding neutron production for all fusion approaches

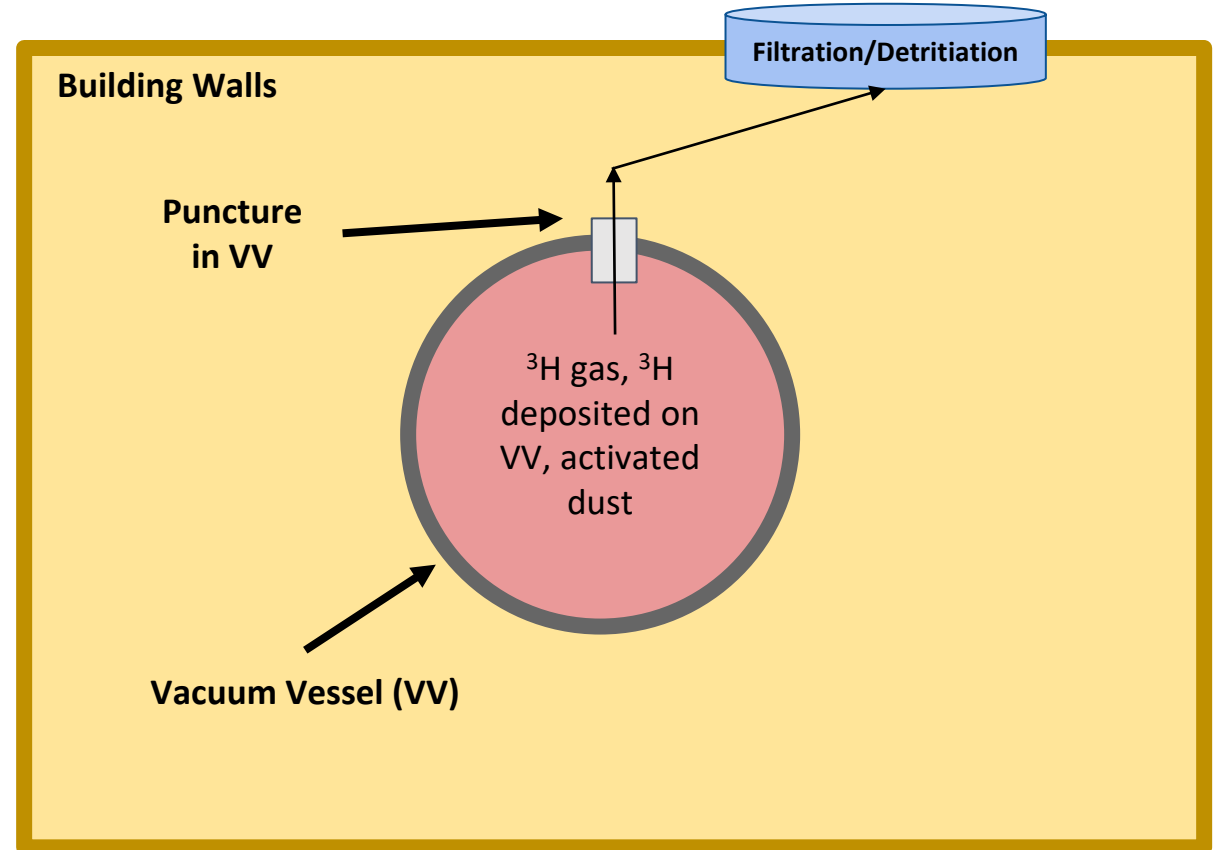

Description. Dose due to fusion neutrons and gammas, which are mitigated using blankets and/or shielding

Offsite Impact. \ll 10 mrem/year during normal operations

Off-Normal Shutoff of Fusion Energy Systems

Key Concepts for Off-Normal Shutoff Scenarios

- **Fusion can be stopped at any time and is not a nuclear chain reaction (no risk of supercriticality)**
 - Off-normal conditions generally stop fusion, which stops neutron generation
 - Any remaining emissions are gamma from activated materials at a much lower level than normal operations
 - No risk of runaway chain reactions like in fission reactors, with small amount of fuel able to be fused at any time
 - No need for active cooling systems in order to cool down components when fusion is stopped like in fission systems
- **Accident scenarios are bounded by the releasable inventory of radionuclides at shutdown**
 - Similar system to other materials facilities like accelerators
 - Managing a fixed inventory of radionuclides is simpler than fission systems
 - The fusion device itself is not the hazard during an accident scenario
- **Analysis in this presentation focuses on releasable material within the vacuum vessel, not independent tritium management systems**
 - Important to consider independent tritium management systems in future facility licensing, but already addressed within a Part 30 construct

Radionuclide Release Consideration for Off-Normal Shutoff Scenarios

- **Tritium Release**

- Scenarios focus on the release of tritium oxide in the form of tritiated water (HTO)
 - Tritium oxides are of greater importance for calculating doses than elemental tritium (HT), and correspondingly HTO is the focus of this analysis
 - A conservative assumption of 10% conversion of released tritium to tritium oxides is used, consistent with previous analyses by Los Alamos National Laboratory (LANL)* and used by the UKAEA for JET licensing**

- **Activated Dust Release**

- Dust from plasma-facing components that have activated and eroded
- Equivalent to small amounts of low-level radioactive waste
- Material choices for plasma-facing components significantly impact quantity of dust generation and radionuclide composition

* P.S. Ebey, CONVERSION OF TRITIUM GAS INTO TRITIATED WATER (HTO): A REVIEW WITH RECOMMENDATIONS FOR USE IN THE WETF SAR, LA-UR-01-1825, Los Alamos National Laboratory (2001).

**A. Bell, "The Safety Case for JET D-T Operation," JET-P, (1999).

Off-Normal Shutoff – Safety Systems Considered

- Only systems that will be universal among FIA members were considered to ensure a conservative analysis that is widely applicable to FIA members
- Additional safety systems and features unique to each fusion system design must be considered to more accurately reflect inventory release during off-normal operation

Universal systems considered in analysis

Building Walls Containing Fusion Device

The outer walls of the building confine tritium to exit through designated subsystems

The assumed building wall height is 10 m

Filtration and Detritiation Systems and Potential Use of Stacks

Building exhaust is passed through filters and/or detritiation subsystems

The use of a stack to increase release height of radionuclides (all scenarios in this presentation considered use 10 m release height, but taller stacks could be used)

Off-Normal Shutoff & Tritium: History

- NRC has previously evaluated historical accidental releases of tritium from Part 30/40/70 licensees
- Previous accidents include:
 - 50 g tritium release through a stack at Savannah River Laboratory (1974)
 - 30 g tritium release at American Atomics Corp (1978)
- NRC found no evidence that any accident caused an effective dose equivalent to any offsite person more than 10 mrem (well below the public dose limit 100 mrem/yr)
- Provides real-world context for scenarios considered for this presentation

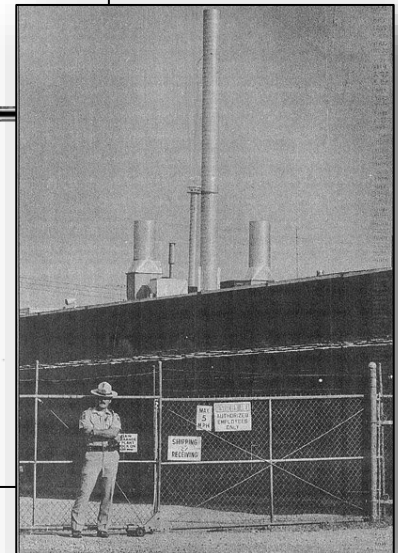
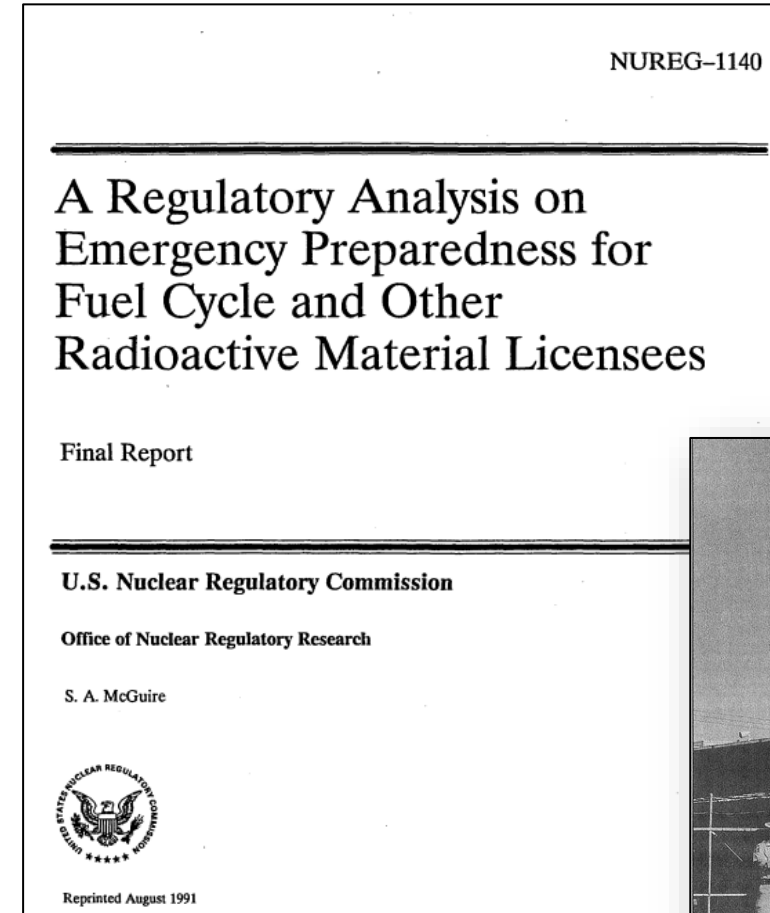

HotSpot Code from LLNL to Calculate Release Effects of Interest

- HotSpot provides a set of software tools for evaluating the impact of incidents involving airborne radionuclides
- Models for near-surface releases, short-range (< 10 km), and short-term release durations (< 24 hours) with a variety of atmospheric conditions
- Provides a conservative estimate of radiation effects
- Quantity of interest: total effective dose equivalent (TEDE), the sum of:
 - External dose in the first four days (DDE)
 - Internal dose over 50 years (CEDE)
- “Tritium Release” (HTO) dispersion model is used
 - The HotSpot default receptor height, breathing rates, quality factors, and deposition velocities are used

- S.G. Homann, F. Aluzzi, “HotSpot Health Physics Code Version 3.0 User’s Guide,” National Atmospheric Release Advisory Center, Lawrence Livermore National Laboratory, LLNL-SM-636474, (2014).
- US DOE, “Software Evaluation of HotSpot and DOE Safety Software Toolbox Recommendation,” Office of Health, Safety and Security, US Department of Energy, DOE/HS-0003, (2007).



HotSpot

Version 3.1.2 - February 11, 2020

Steven G. Homann
National Atmospheric Release Advisory Center
(NARAC)
Lawrence Livermore National Laboratory

Customer Support
hotspot@llnl.gov
[HotSpot Home Page](#)

© 2013. Lawrence Livermore National Security, LLC. All rights reserved.

Total Effective Dose Equivalent (TEDE) varies with released HTO quantity, height, and atmospheric conditions

Release of tritiated water (HTO) is directly proportional to the TEDE

Increasing release height using stacks can significantly reduce TEDE

Higher wind speeds and lower atmospheric stability (A → F) tends to decrease TEDE

For a given set atmospheric conditions, minimize the quantity of HTO released and increase release height to reduce the TEDE

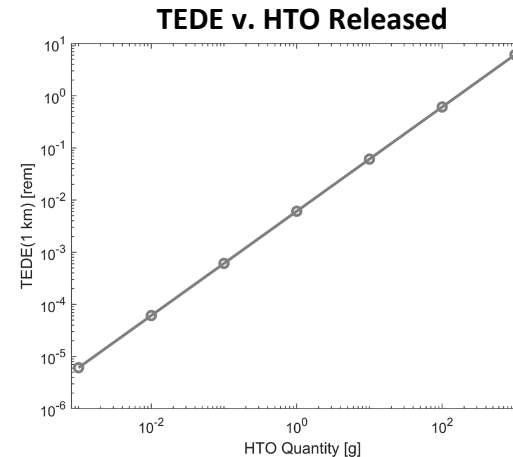

TEDE 1 km downwind versus quantity of HTO released. Assumes 1 m/s wind speed, F-grade stability, and 10-m release height.

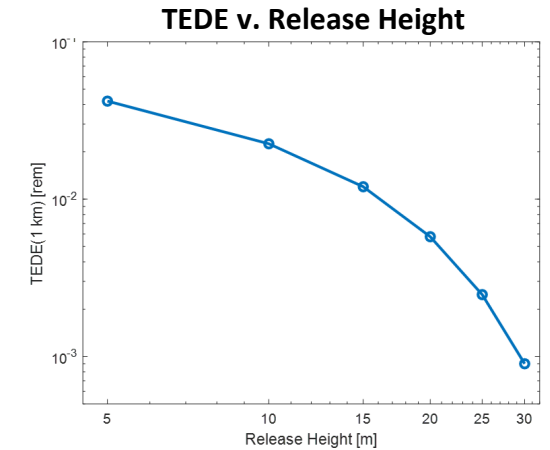

TEDE 1 km downwind versus release height. Assumes 1 m/s wind speed, F-grade stability, and 0.15 g of HTO released.

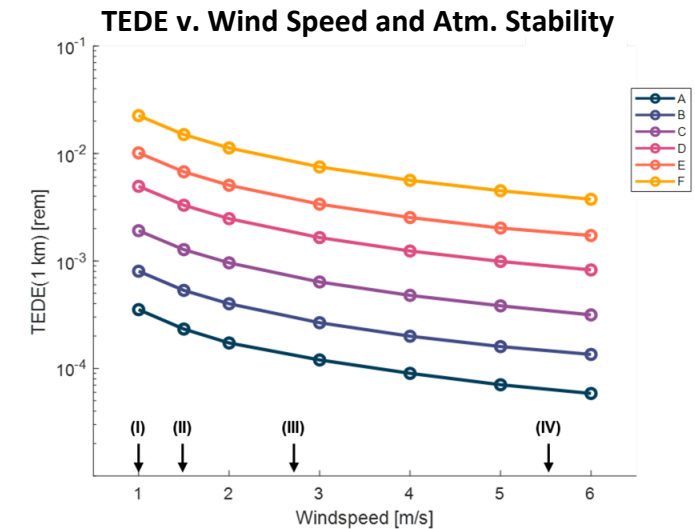

TEDE 1 km downwind as a function of windspeed for atmospheric stabilities A-F. Assumes 10-m release height and 0.15 g HTO released.
 (I). Conservative windspeed to use in accident analysis according to NUREG-1140.
 (II). Conservative windspeed to use in chemical accident analysis according to EPA (40 CFR 68.22(b)).
 (III). Average windspeed in Phoenix, AZ.
 (IV). Average windspeed in Boston, MA.

Assumptions for Off-Normal/Accident Scenarios

Device contains 100 mg of tritium gas within the VV and 50 g of tritium deposited on VV wall at shut off

A puncture in the VV results in air rushing into chamber (unlike a pressurized system), and only a portion of the tritium leaves the chamber (70% remains embedded in the VV walls)

Of the tritium leaving the VV, the conservative assumption is a 10% conversion to HTO

Blanket, shielding, and additional structural components and subsystems not considered in this conservative analysis

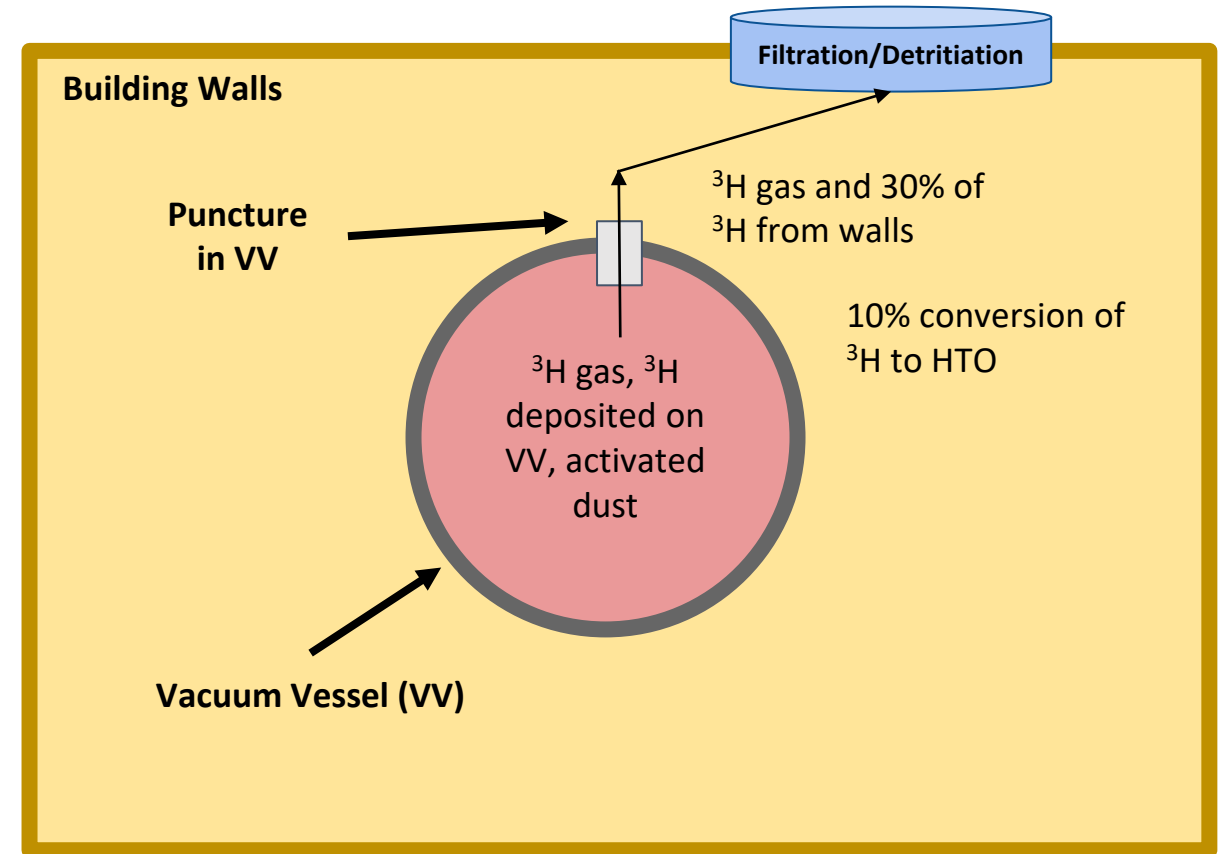

- Dept. for Business, Energy & Industrial Strategy, "Towards Fusion Energy: The UK Government's proposals for a regulatory framework for fusion energy," Presented to Parliament by Sec. of State for Bus., Energy, and Industrial Strategy by Command of Her Majesty, (2021).
- Fusion Safety Authority, "Technology Report – Safety and Waste Aspects for Fusion Power Plants," UKAEA, UKAEA-RE(21)01, Issue 1, (2021).
- Radiation (Emergency Preparedness and Public Information) Regulations (REPPiR), (2019).
- P. Ebej, "Conversion of Tritium Gas into Tritiated Water (HTO): A Review with Recommendations for use in the WETF SAR" LA-UR-01-1825.
- A. Bell, "The Safety Case for JET D-T Operation," JET-P, (1999).

Analysis Results for Accident Scenario 1

Description: VV is punctured, but building walls and filtration and/or detritiation systems remain intact

- All tritium gas and 30% of tritium on wall leaves the VV
- Of the tritium leaving VV, 10% is converted to HTO
- All released HTO exits through filtration/detritiation system and stack

Offsite Impact : < 0.1 mrem

The United Kingdom Atomic Energy Authority calculated a 0.01% - 0.001% probability of this level of accident occurring in one year, using the REPPIR 2019 approved code of practice.

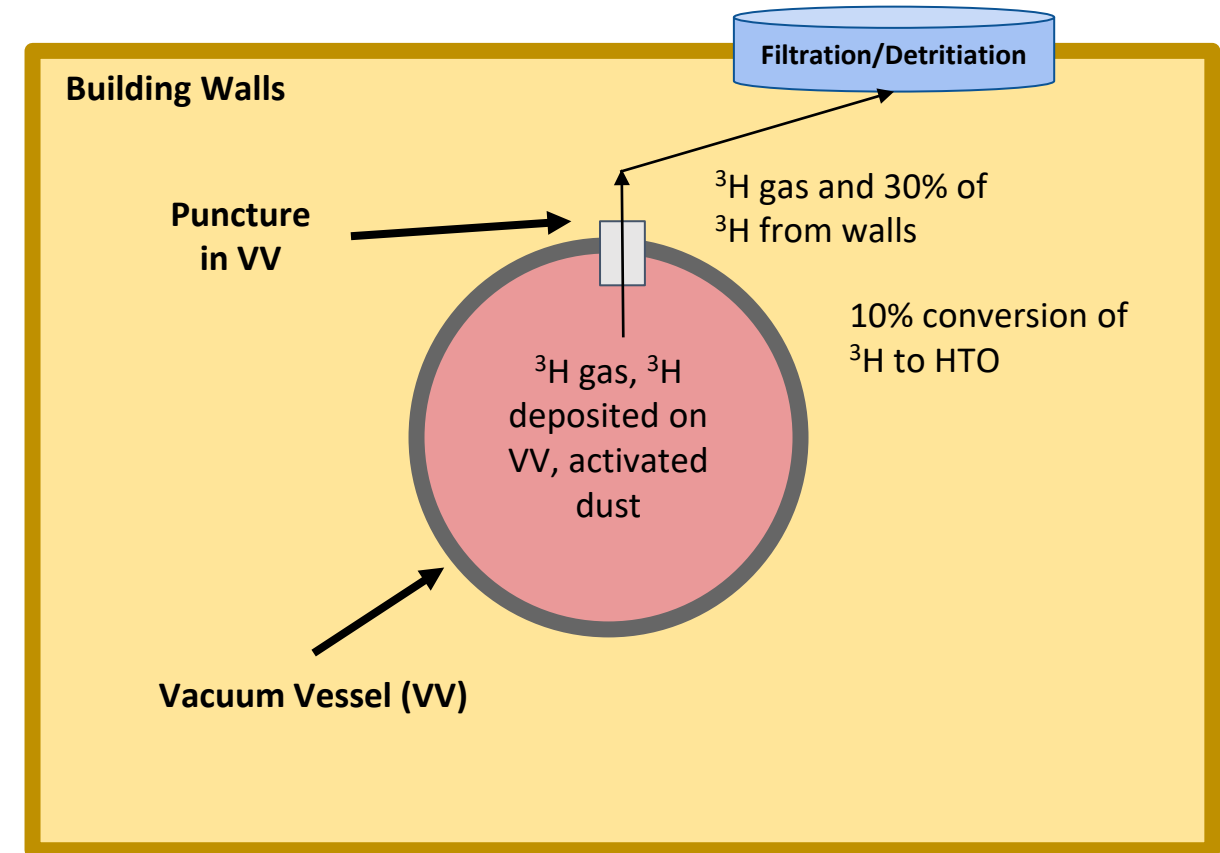

- Dept. for Business, Energy & Industrial Strategy, "Towards Fusion Energy: The UK Government's proposals for a regulatory framework for fusion energy," Presented to Parliament by Sec. of State for Bus., Energy, and Industrial Strategy by Command of Her Majesty, (2021).
- Fusion Safety Authority, "Technology Report – Safety and Waste Aspects for Fusion Power Plants," UKAEA, UKAEA-RE(21)01, Issue 1, (2021).
- Radiation (Emergency Preparedness and Public Information) Regulations (REPPIR), (2019).
- P. Ebej, "Conversion of Tritium Gas into Tritiated Water (HTO): A Review with Recommendations for use in the WETF SAR" LA-UR-01-1825.
- A. Bell, "The Safety Case for JET D-T Operation," JET-P, (1999).

Analysis Results for Accident Scenario 2

Description: VV is punctured, building walls and filtration and/or detritiation are damaged such that there is 10% leakage of HTO

- All tritium gas and 30% of tritium on wall leaves the VV
- Of the tritium leaving VV, 10% is converted to HTO
- 10% of HTO is released into the environment at a release height of 10 m (height of building)

HTO Emitted = 0.15g

- $(0.1 \text{ g} + (.3)(50 \text{ g}))(.1)(.1) = 0.15 \text{ g}$
- $(^3\text{H Gas} + (\% \text{ off wall})(^3\text{H on wall}))(\% \text{ to HTO})(\% \text{ leak}) = \text{HTO emitted}$

Offsite Impact: < 40 mrem ← *Less than the 100 mrem annual public dose limit to the public*

The United Kingdom Atomic Energy Authority calculated a one in a million in one year probability of this level of accident occurring in one year, using the REPPiR 2019 approved code of practice

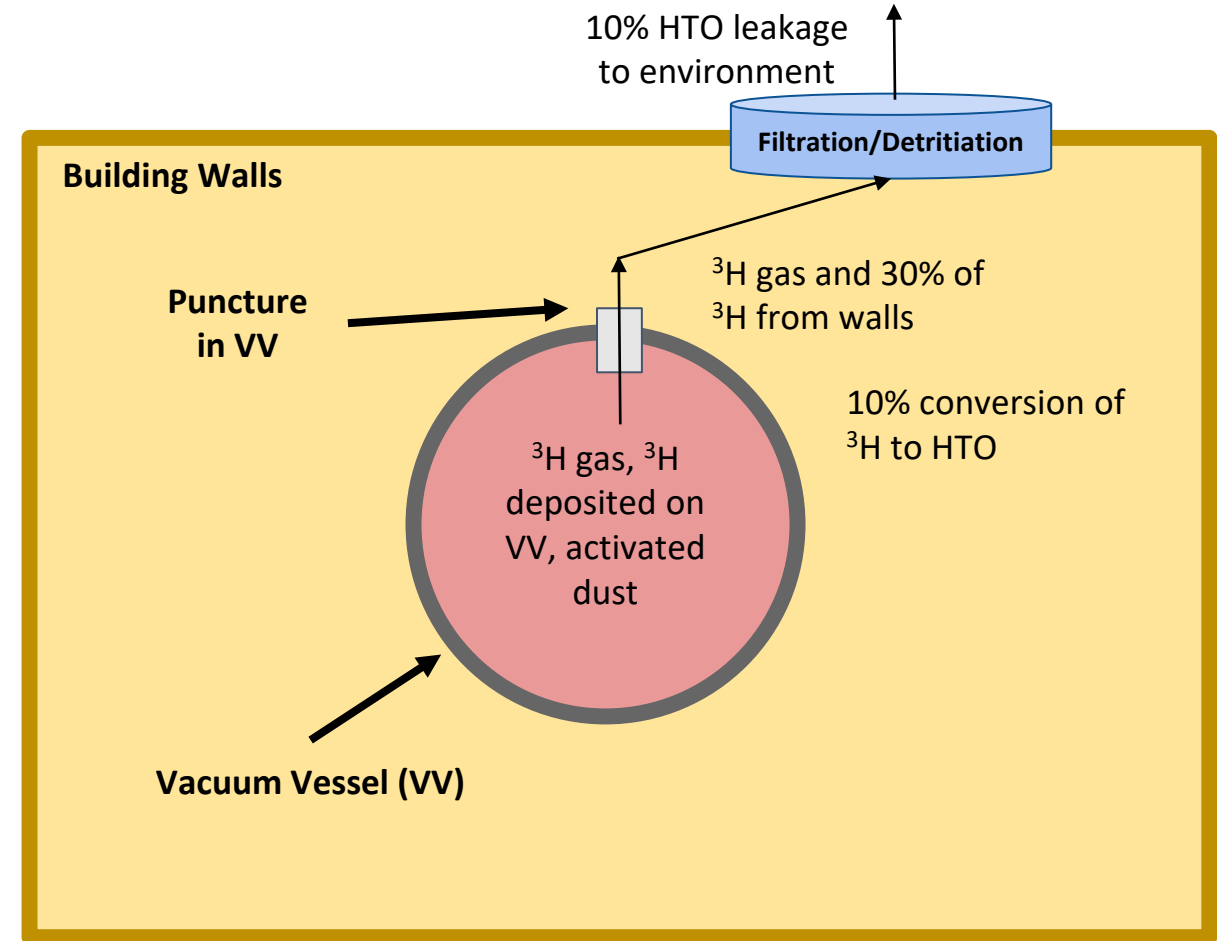

- Dept. for Business, Energy & Industrial Strategy, "Towards Fusion Energy: The UK Government's proposals for a regulatory framework for fusion energy," Presented to Parliament by Sec. of State for Bus., Energy, and Industrial Strategy by Command of Her Majesty, (2021).
- Fusion Safety Authority, "Technology Report – Safety and Waste Aspects for Fusion Power Plants," UKAEA, UKAEA-RE(21)01, Issue 1, (2021).
- Radiation (Emergency Preparedness and Public Information) Regulations (REPPiR), (2019).
- P. Ebey, "Conversion of Tritium Gas into Tritiated Water (HTO): A Review with Recommendations for use in the WETF SAR" LA-UR-01-1825.
- A. Bell, "The Safety Case for JET D-T Operation," JET-P, (1999).

Analysis Results for Accident Scenario 3

Description: VV is punctured, building walls and filtration and/or detritiation are damaged such that there is 100% leakage of HTO

- All tritium gas and 30% of tritium on wall leaves the VV
- Of the tritium leaving VV, 10% is converted to HTO
- 100% of HTO is released into the environment at a release height of 10 m (height of building)

HTO Emitted = 1.5g

- $(0.1 \text{ g} + (.3)(50 \text{ g}))(.1)(1) = 1.5 \text{ g}$
- $(^3\text{H Gas} + (\% \text{ off wall})(^3\text{H on wall}))(\% \text{ to HTO})(\% \text{ leak}) = \text{HTO emitted}$

Offsite Impact < 401 mrem

- Maximum dose occurs at 0.47 km
- Dose at 1.00 km = 230 mrem

Less than the 1000 mrem emergency planning threshold

The United Kingdom Atomic Energy Authority calculated a **one in ten million in one year** probability of this level of accident occurring in one year, using the REPPiR 2019 approved code of practice

- Dept. for Business, Energy & Industrial Strategy, "Towards Fusion Energy: The UK Government's proposals for a regulatory framework for fusion energy," Presented to Parliament by Sec. of State for Bus., Energy, and Industrial Strategy by Command of Her Majesty, (2021).
- Fusion Safety Authority, "Technology Report – Safety and Waste Aspects for Fusion Power Plants," UKAEA, UKAEA-RE(21)01, Issue 1, (2021).
- Radiation (Emergency Preparedness and Public Information) Regulations (REPPiR), (2019).
- P. Ebey, "Conversion of Tritium Gas into Tritiated Water (HTO): A Review with Recommendations for use in the WETF SAR" LA-UR-01-1825.
- A. Bell, "The Safety Case for JET D-T Operation," JET-P, (1999).

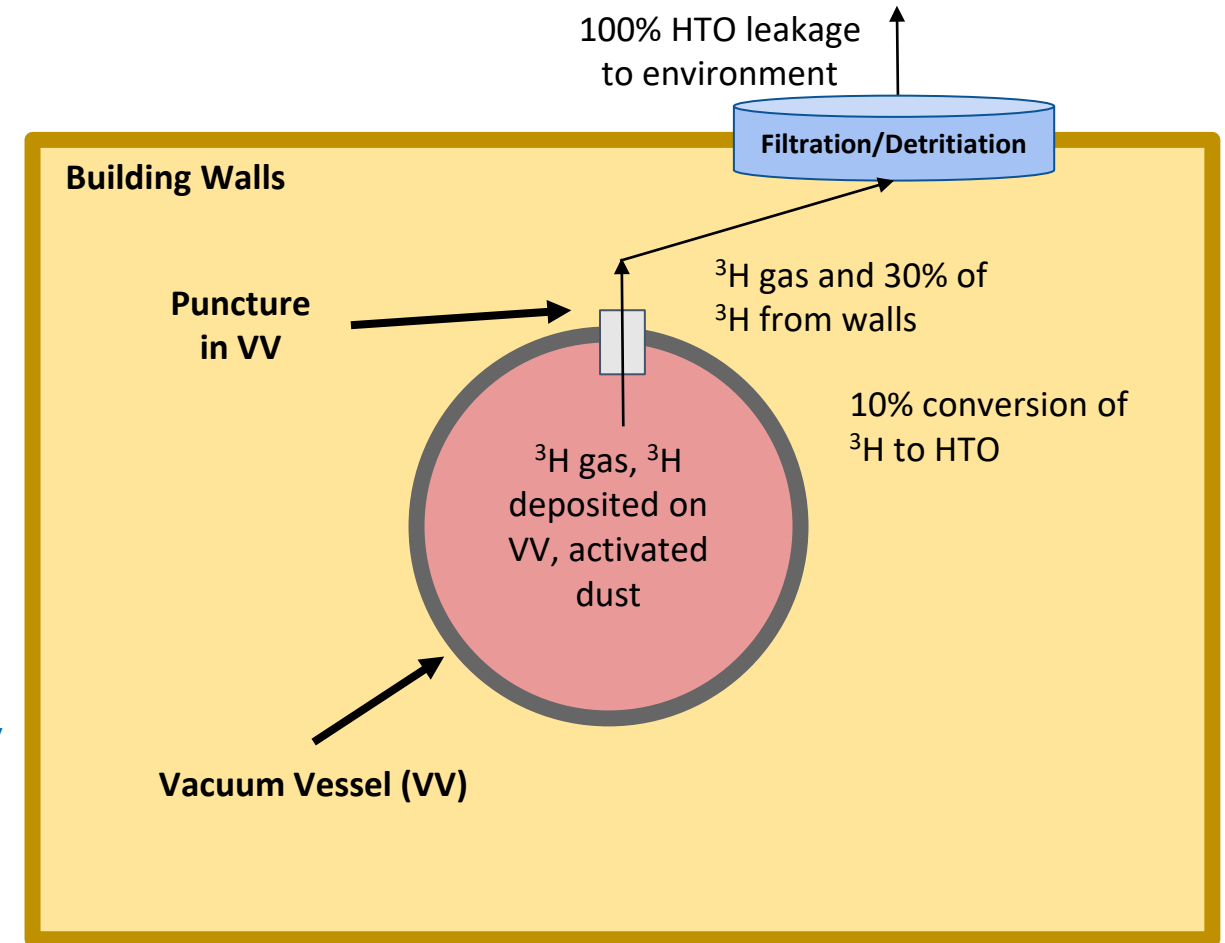

Use of stacks is a common approach to further reduce offsite impacts from radionuclide releases

The accident scenarios considered in this presentation all used a release height of 10 m (release through the top of the building containing the fusion device)

The use of stacks to increase release height can reduce offsite total effective dose equivalent (TEDE) considerably

Increasing stack height from 10 m to 30 m can reduce TEDE by more than a factor of 10

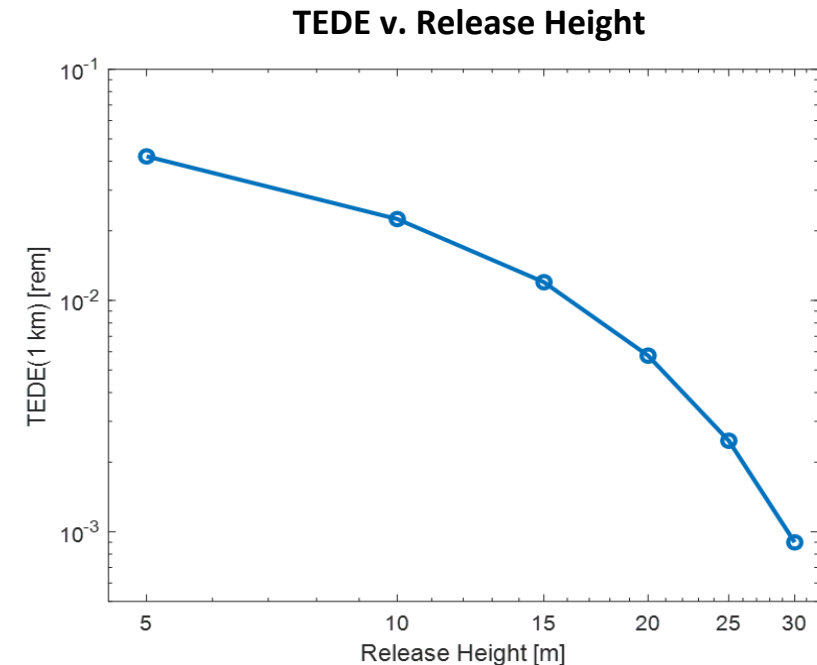

TEDE 1 km downwind versus release height. Assumes conservative 1 m/s wind speed, F-grade stability, and 0.15 g of HTO released.

Tritium release accident scenario conclusions

- When VV is punctured, fusion reactions immediately stop in all cases
 - Machine is not the hazard
 - Neutron production stops
 - The tritium inventory is fixed
- Variety of commonly used safety systems ameliorates accident risks to the public health and safety
- Analysis is conservative and demonstrates that FIA members are below the emergency (evacuation) planning threshold of 1000 mrem

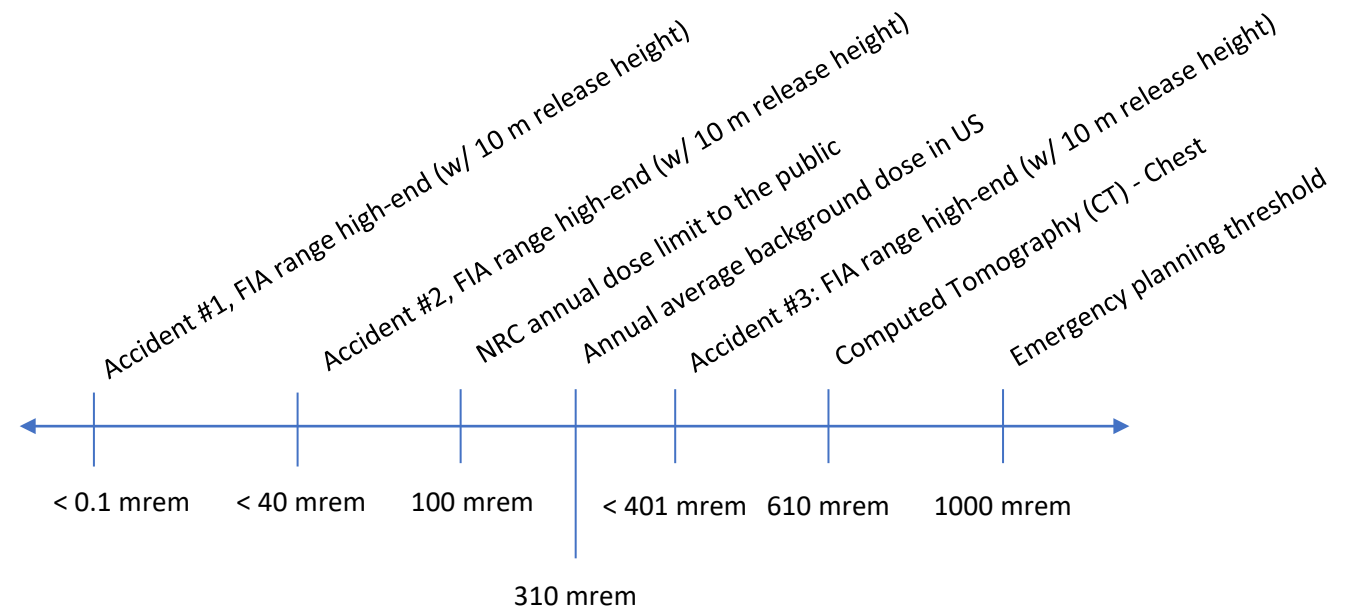

Calculations of the contribution from dust to offsite impacts is underway by FIA members

- First wall material choices and system specifics will affect the quantities of dust generation and composition of activated dust in fusion systems
- Additional contributions to potential offsite impacts are expected to be low compared to tritium releases considered in the scenarios in this presentation
- Additional information will be provided by FIA members on the contributions of activated dust once analyses are completed
- Use bounding case of JET and ITER using a tungsten wall to estimate activated dust accumulation contributions to radionuclide inventory of the system

Bounding case for dust generation using JET data and ITER analyses scaled to high-end of FIA survey range

Use data from JET and for an ITER-like wall as bounding case for dust generation

Amount of dust on wall obtained from JET experimental analysis

- 1.4 g per 19.1 hours of plasma operation – 1.8 g of dust per day of plasma operation

Use amount of activation per gram of dust from ITER study (not all dust is activated) and scale down to high-end of FIA scale

Perform analysis at distance where dose is maximized, consistent with the other conservative analyses in this presentation

Assuming a quarterly cleanout of dust, providing a maximum of ~156 g of dust in the vacuum vessel at any time

- M. Rubel, et al., “Dust generation in tokamaks: Overview of beryllium and tungsten dust characterization in JET with the ITER-like wall,” *Fusion Engineering and Design*, **136**, 2018.

With a maximum inventory of 156 g of dust at any time, additional contribution to offsite impact is small (< 10%)

Accident Scenario	Previous Offsite Maximum TEDE	Additional Maximum Contribution to TEDE	Offsite Maximum TEDE w/ Dust
#1	< 0.1 mrem	< 0.1 mrem	< 0.1 mrem
#2	< 40 mrem	< 3.8 mrem	< 43.8 mrem
#3	< 401 mrem	< 38 mrem	< 439 mrem

Note: analysis conservatively assumes all dust leaves vacuum vessel, unlike the 30% release used for tritium.

Contribution to offsite TEDE with the inclusion of released activated dust is small (< 10%) and does not change the outcome of considered scenarios with respect to annual public dose (100 mrem) and emergency planning (1000 mrem) thresholds

Summary

- Fusion systems have zero usage of special nuclear materials, and fusion is not a nuclear chain reaction
- Normal fusion operations can produce neutrons and gamma rays, which can be effectively shielded using currently in-use materials
- Off-normal events result in automatic shutdown of fusion reactions, and cannot lead to a meltdown
- Tritium releases in credible accidents are below the annual dose limit to the public of 100 mrem, and in all scenarios are below emergency planning threshold of 1000 mrem
- Refined dust analyses are underway by FIA members, but contribution to offsite impact is expected to be low compared to tritium
- The offsite impacts are akin to those of byproduct materials licensees, not of fission reactors that use special nuclear materials and are based on nuclear chain reactions
- Offsite impact risk for fusion is low relative to utilization facilities and do not support a design basis/beyond design basis construction

Agenda

Time	Topic	Speaker
1:00 pm	Introductions	NRC
1:15 pm	Identification and Characterization of Fusion Hazards	Dr. Patrick White
2:15 pm	Overview of Fusion Industry Association Member Company Commercial Device Operational & Off-Normal Safety Case	Andrew Holland, Fusion Industry Association & Derek Sutherland, CT Fusion
3:30 pm	Break	
3:40 pm	Overview of Tritium Handling Systems	Tyler Ellis, Commonwealth Fusion Systems
4:25 pm	Supplemental Discussion of the Helion Device Safety Case	David Kirtley, Helion Energy
4:55 pm	Question and Answer Period	
5:30 pm	Adjourn	

CFS Technology Overview

Tyler Ellis, Ph.D.



Fusion energy is sustained by self-heating and recycled neutrons



Energy Before (MeV)

Energy After (MeV)

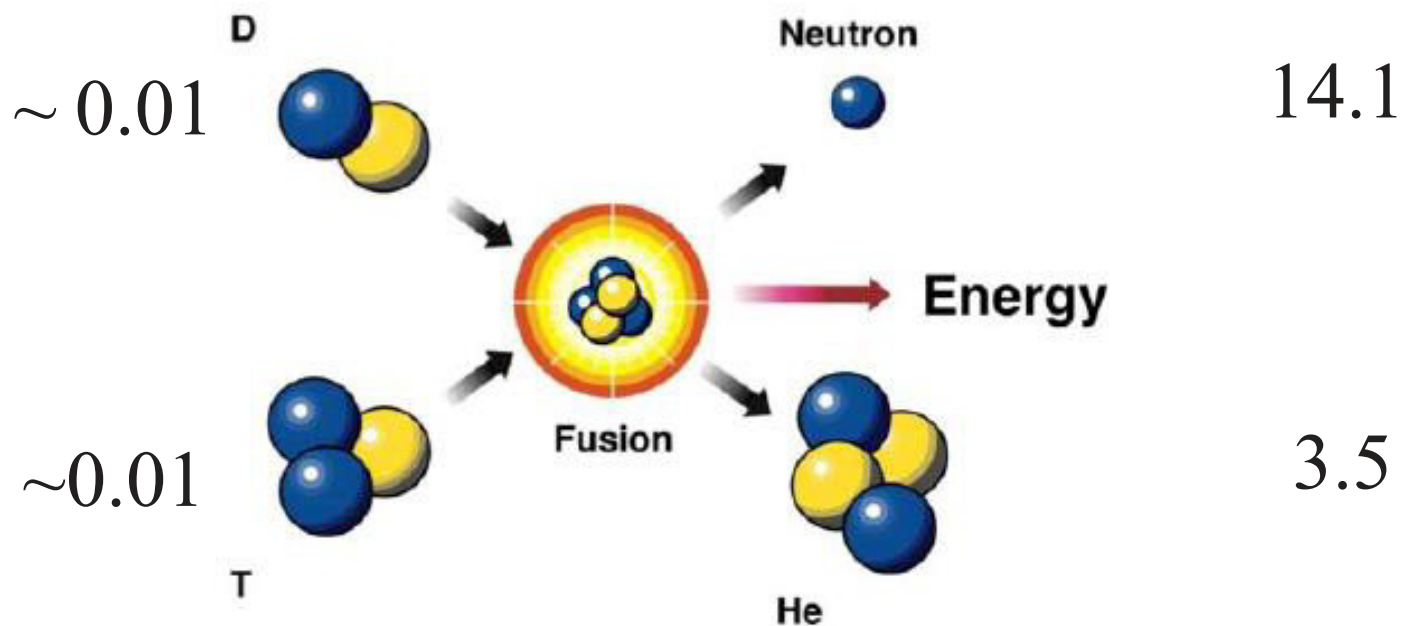

Fuel in plasma state: $T=10 \text{ keV} \sim 100 \text{ million C}$

Fusion energy is sustained by self-heating and recycled neutrons



Energy Before (MeV)

Energy After (MeV)

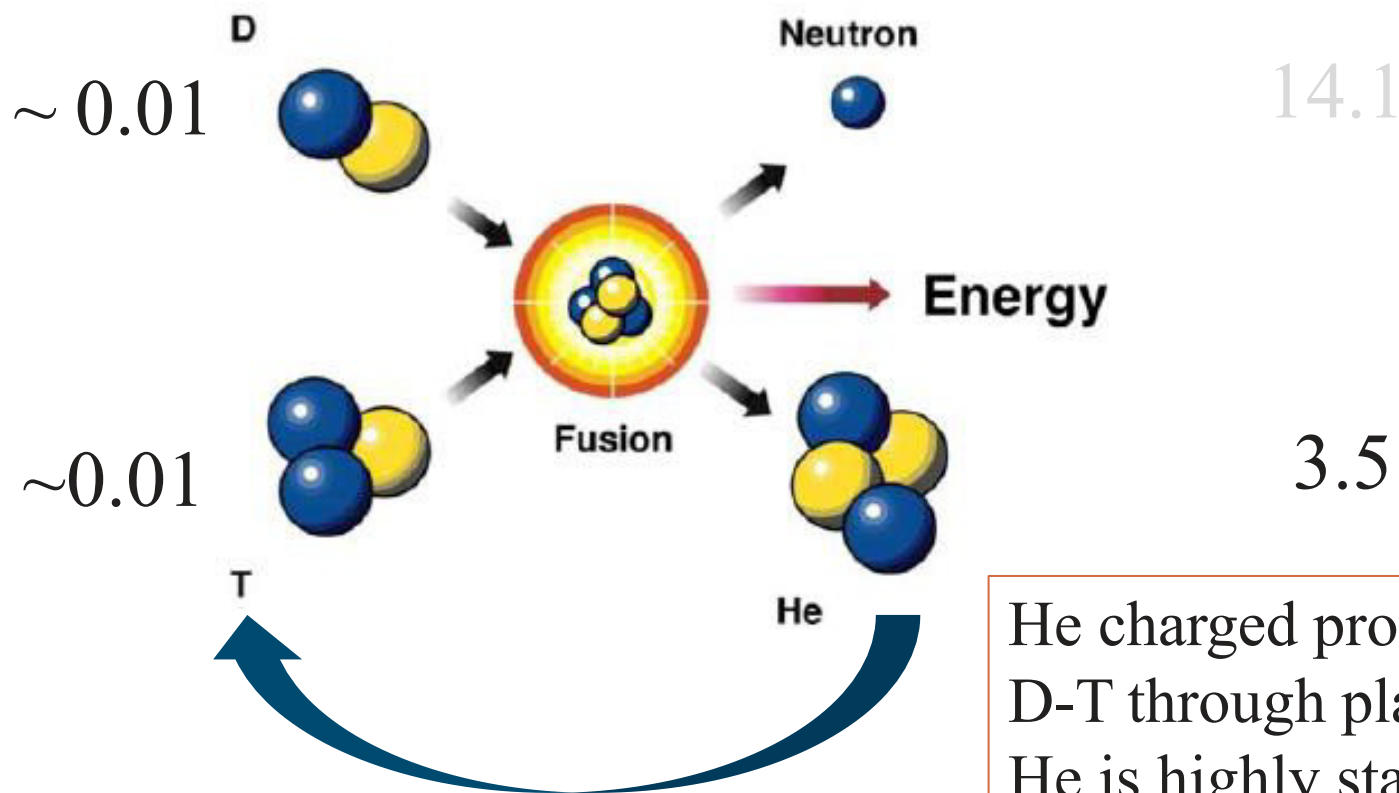

He charged product heats the D-T through plasma collisions
He is highly stable, cannot undergo further reactions

Fusion energy is sustained by self-heating and recycled neutrons



Energy Before (MeV)

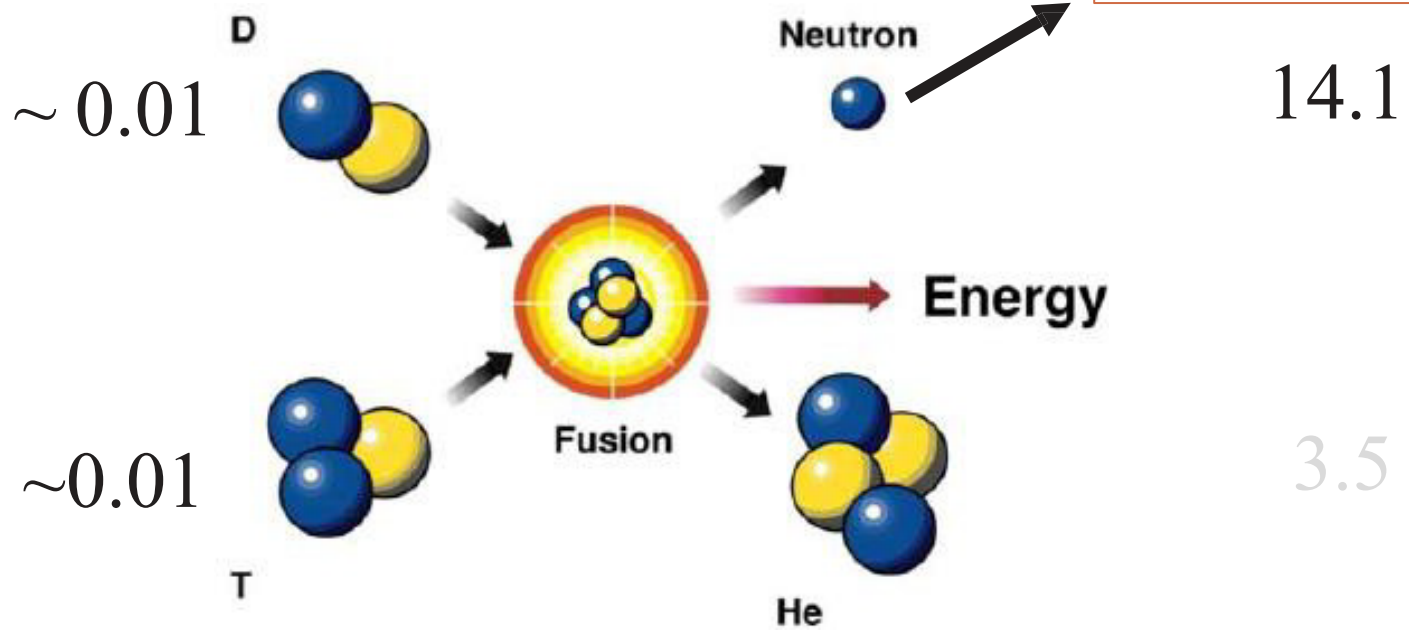

Neutron lacks charge and escapes plasma with 80% of the fusion energy

Fusion energy is sustained by self-heating and recycled neutrons



Energy Before (MeV)

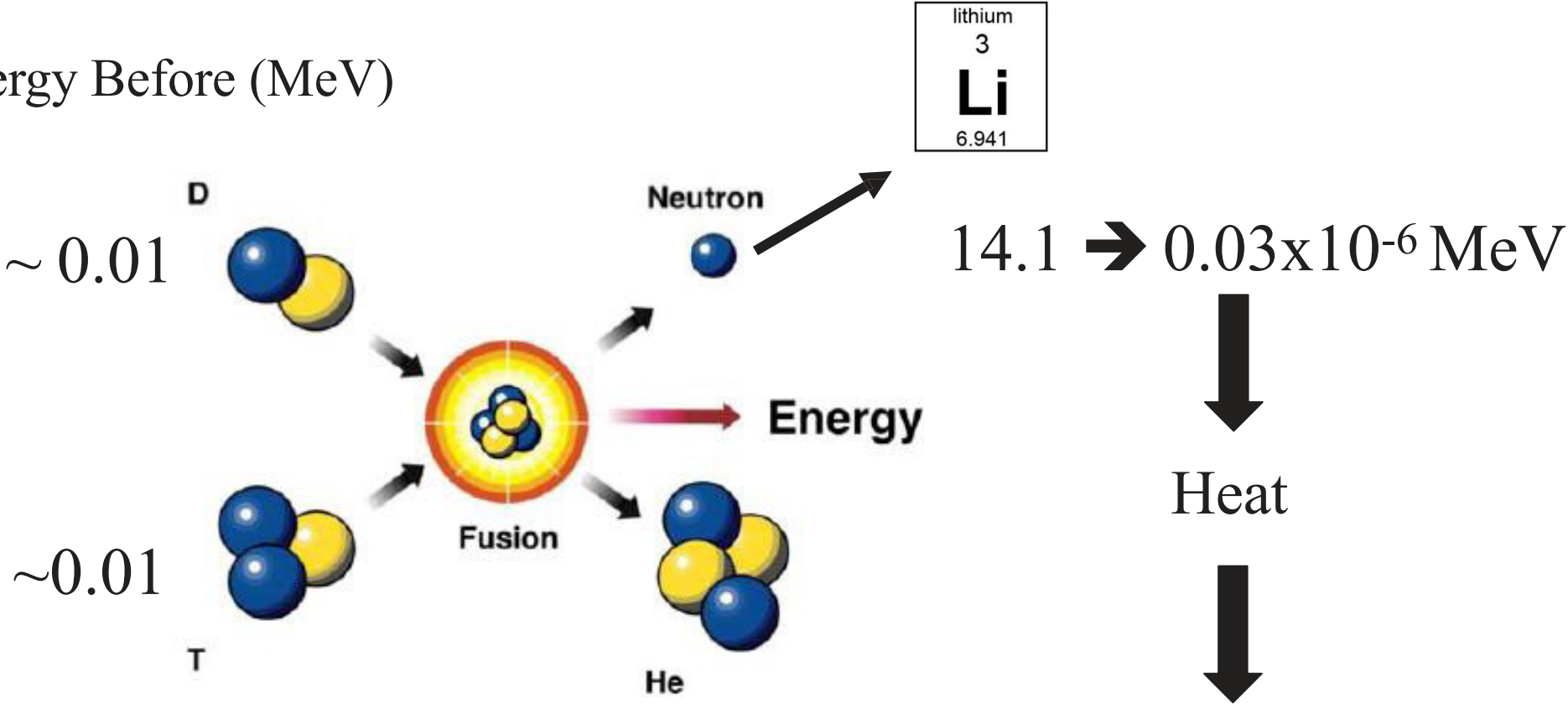

Neutron undergoes collisions with nuclei in surrounding blanket material like lithium

Fusion energy is sustained by self-heating and recycled neutrons



Energy Before (MeV)

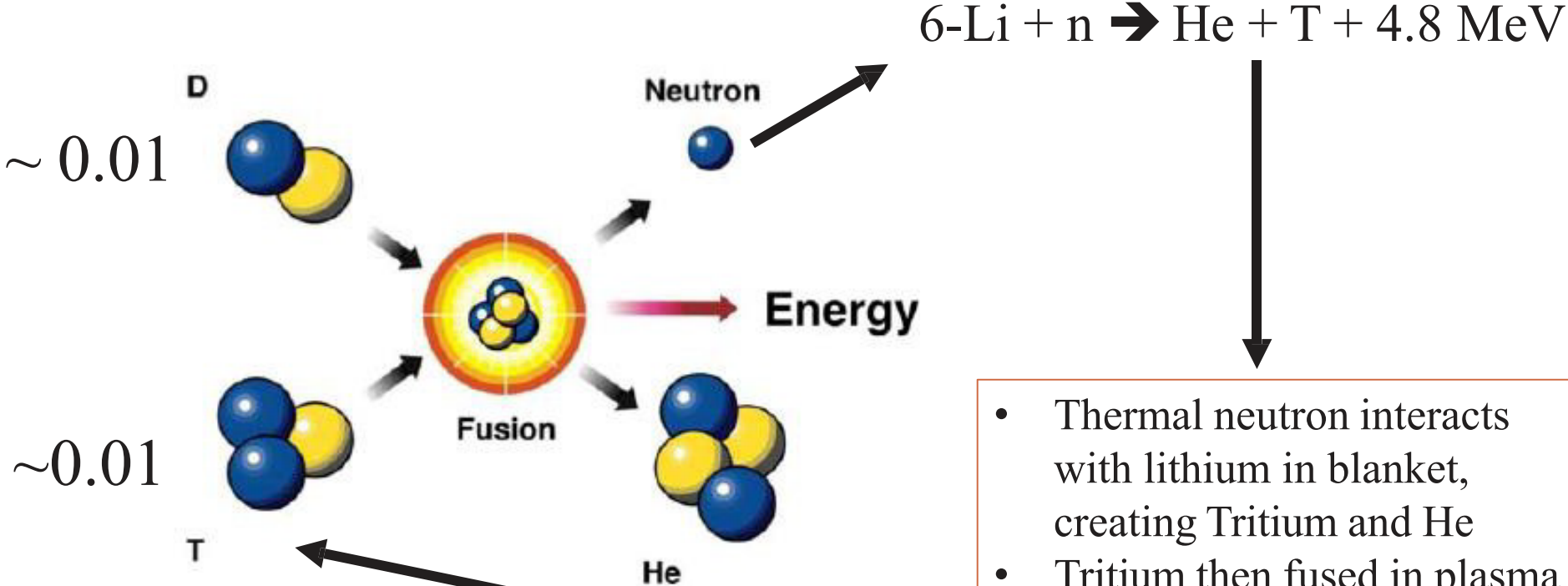

- Thermal neutron interacts with lithium in blanket, creating Tritium and He
- Tritium then fused in plasma
- If Tritium / neutron > 1, then fusion only needs deuterium and lithium as fuel inputs



Fusion power balance controlled by three parameters: density of fuel, confinement time and fuel temperature

- Energy confinement time is defined as the ratio of plasma thermal energy density (W) to power density lost by plasma

$$\tau_E = \frac{W}{P_{loss}}$$

- Plasma stored energy set by plasma density (n) and temperature (T)

$$W = 3nT$$

- Fusion volumetric reaction rate is dependent on the plasma density and the fusion reaction rate R which depends on T

$$p_{fusion} = \frac{1}{4}n^2R(T)$$

- The power lost by the plasma must be balanced by the fusion power generated in the charged particles to sustain the temperature

$$p_{fusion}E_{charge} \geq P_{loss}$$

- Combining the above, creates the Lawson Criteria: a minimum of the product of energy confinement time and the plasma density as a function of temperature which for D-T fusion

$$n\tau_E \geq \frac{12T}{E_{charge}R(T)}$$

- Sometimes multiplied with temperature to form the “triple product”

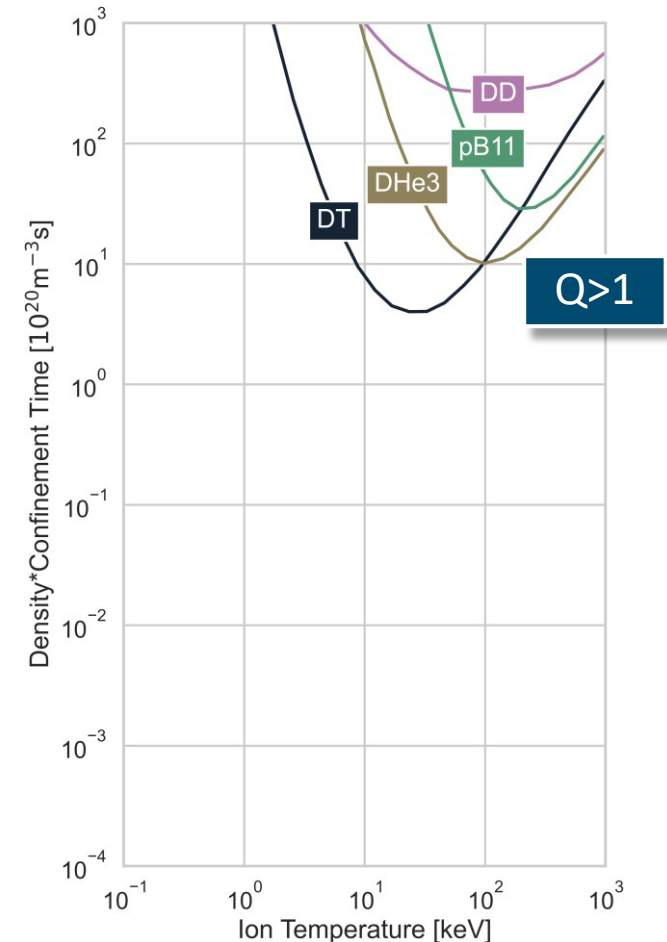



Fusion power balance controlled by three parameters: density of fuel, confinement time and fuel temperature

- Energy confinement time is defined as the ratio of plasma thermal energy density (W) to power density lost by plasma

$$\tau_E = \frac{W}{P_{loss}}$$

T is very high but n very low (1/100,000 of air)
This energy density is less than boiling water

- Plasma stored energy set by plasma density (n) and temperature (T)

$$W = 3nT$$

- Fusion volumetric reaction rate is dependent on the plasma density and the fusion reaction rate R which depends on T

$$p_{fusion} = \frac{1}{4} n^2 R(T)$$

Fusion power controlled by plasma density, which is controlled by puffing gas

- The power lost by the plasma must be balanced by the fusion power generated in the charged particles to sustain the temperature

$$p_{fusion} E_{charge} \geq P_{loss}$$

Fusion reactions sustained by heating, NOT a chain reaction

- Combining the above, creates the Lawson Criteria: energy confinement time and the plasma density and temperature which for D-T fusion

$$n\tau_E \geq \frac{12T}{E_{charge}R(T)}$$

Want to operate near T optimization
Runaway process is physically impossible

- Sometimes multiplied with temperature to form the “triple product”

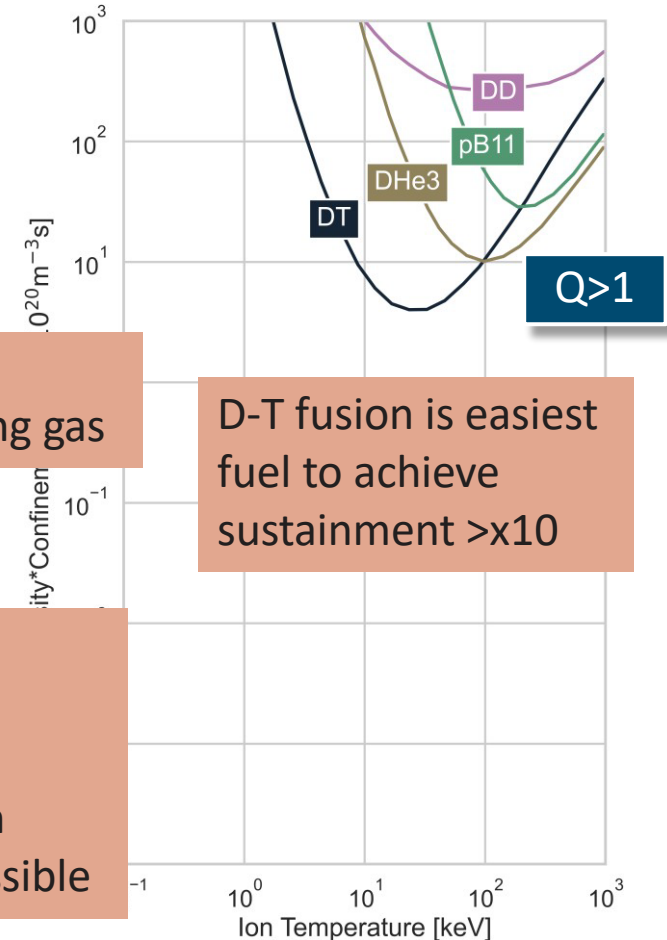



What is a burning plasma?

- Recall $1/5^{\text{th}}$ of fusion power heats plasma, so $Q > 5$ plasma is dominantly heated by its own product (He ions), this is a burning plasma
- Practical energy systems need $Q > 10$ due to energy conversion efficiencies
- SPARC will be a U.S.-based $Q \sim 10$ experiment and will be regulated under 10 CFR 30, at least 10 years ahead of ITER
- A burning plasma is not the same thing as critical mass in fission
- All the same safety attributes of fusion (e.g. defaulting to off in case of loss of power or air leakage in) still apply to burning plasma facilities and higher Q facilities

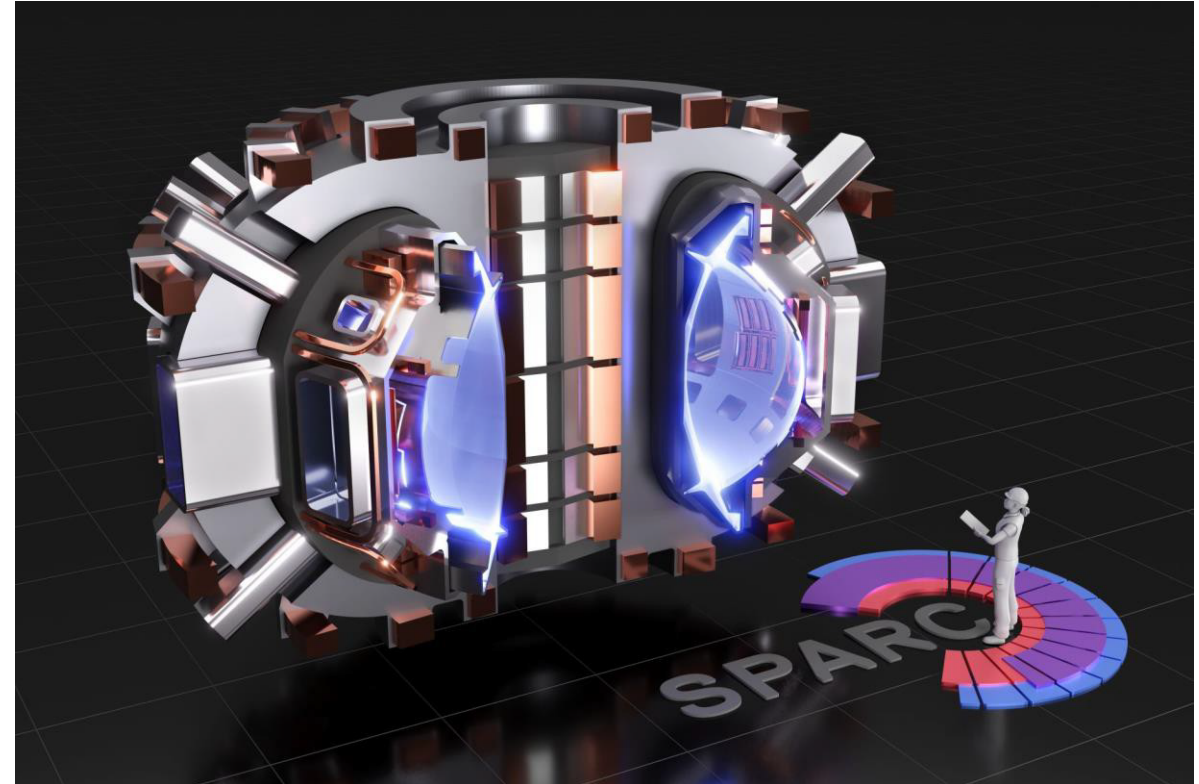

CFS path to commercial fusion energy

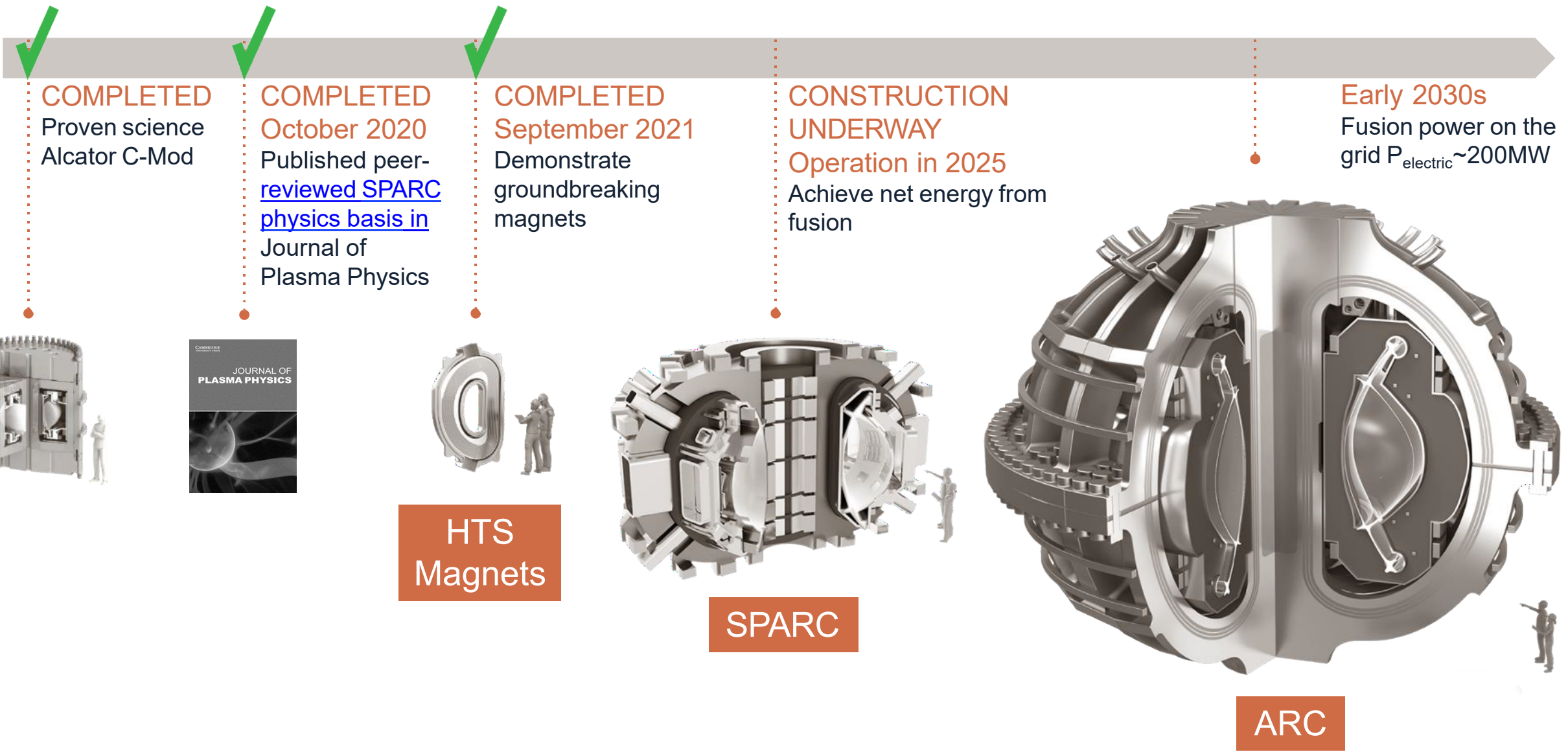

Construction progress as of March 2022



Construction progress as of March 2022





Tritium will be delivered and stored in metal beds

Certified Type B(U) shipping package, 10 g tritium capacity:

- UK Competent Authority: GB/360D/B(U)
- Canadian Nuclear Safety Commission: CDN/E204/-96 (rev 7)
- U.S. Department of Transportation: USA/0596/B(U)-96 rev 6

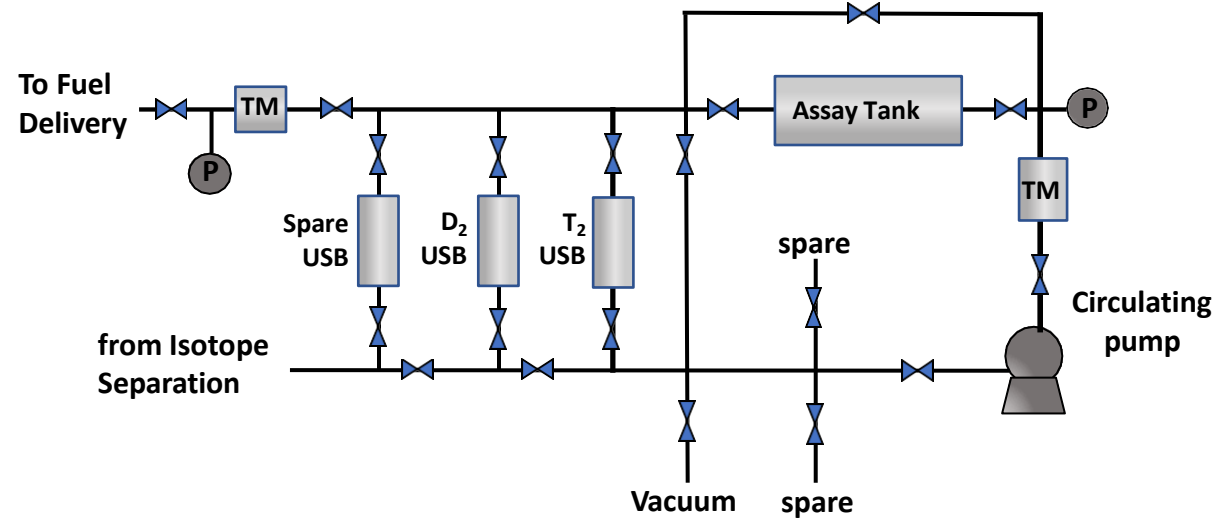
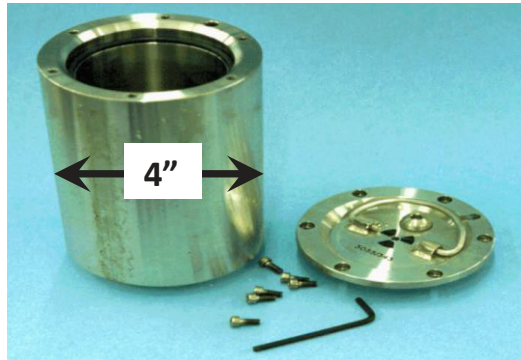

Tritium Storage and Delivery System

functions:

- Remove helium-3
- Assay tritium inventory
- Provide safe storage medium
- Deliver gas to Torus
- Accept gas from isotope separator

Legend:

- TM: Tritium Monitor
- USB: (Depleted) Uranium Storage Bed
- P: Pressure Transducer

DU Storage Bed

3 g T₂ capacity (nominal)





Tritium gas release can be recovered as elemental gas using an inert atmosphere glovebox

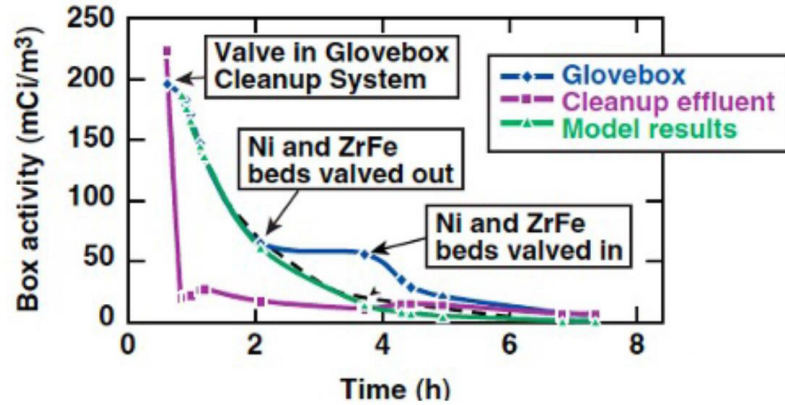

**Net release to the stack
from 1 Ci input:
0.00008 Ci or 80 μ Ci**

Legend:
DP = dew point
TM = tritium monitor
RT = room temperature

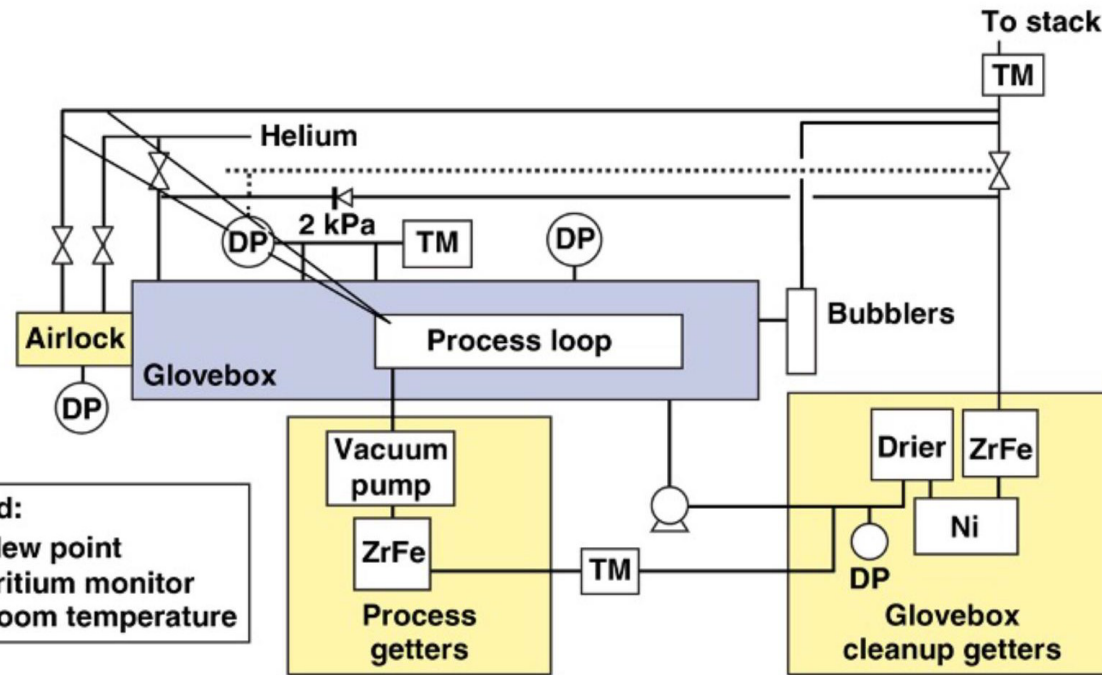

Photo Credit: University of Rochester - LLE

ARC tritium handling system builds on SPARC



- ARC's tritium handling system builds on what is used for SPARC and is different from the cryogenic distillation system that ITER uses
- Tritium burnup: 80.6 g/day
- Tritium decay: 0.03 g/day
- Tritium generation: 88.7 g/day

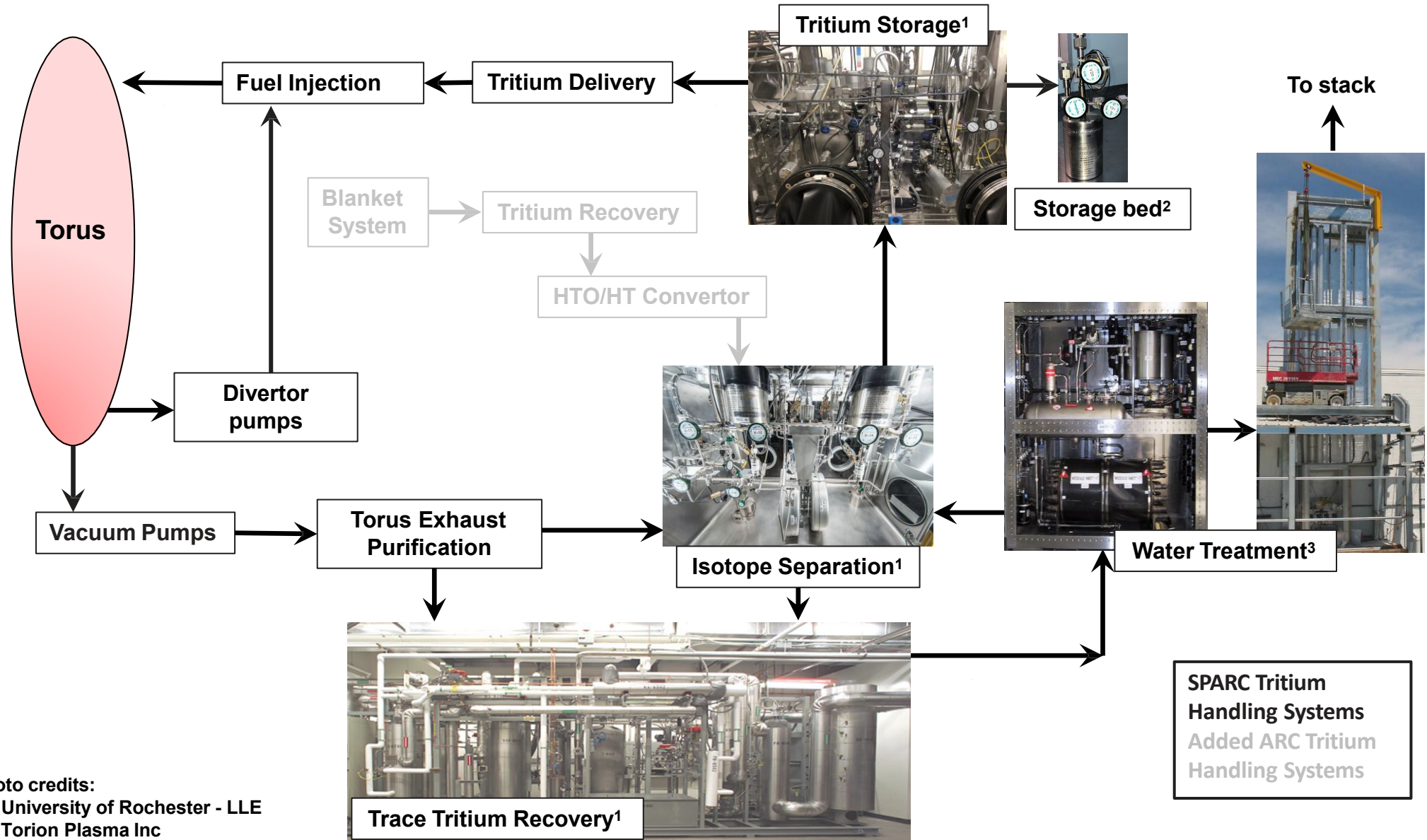

Photo credits:
 1 – University of Rochester - LLE
 2 – Torion Plasma Inc
 3 – Nuclear Sources and Services Inc



SPARC tritium handling systems have significant operational experience

Subsystem	TRL	Operation Experience	Experience (years)
Water Treatment System	9	Nuclear Services and Sources, Inc., AECL, KIT, SCK-CEN	60
Isotope Separation	9	Lab for Laser Energetics (LLE), Univ of Rochester, SHINE Medical Inc. (under construction)	7
Torus Exhaust Purification	6-7	KIT operational experience, Critical component validation at LLE	14
Trace Tritium Recovery	8	LLE (half scale)	18
Tritium Storage and Delivery	9	LLE, Ontario Hydro Research Lab, SHINE	50
Glovebox Cleanup System	9	LLE, Ontario Hydro Research Lab, SHINE	50
Blanket	3	CFS/MIT research and development underway	0
Tritium Recovery System	3	CFS/MIT research and development underway	0
HTO/HT Convertor	4	CFS/MIT research and development underway	0



Fusion can be effectively shielded using existing solutions



- Neutron and prompt gamma shielding with concrete and borated polyethylene
- Activation of components
 - Requires gamma shielding
 - Not a concern during pulses
 - Designs will accommodate for when shielding blocks need to be moved during maintenance
- Dose map modeling to ensure sufficient shield over time as activation products build-up
- Shielding model for SPARC shows that the dose at the site boundary is below regulatory public dose limits

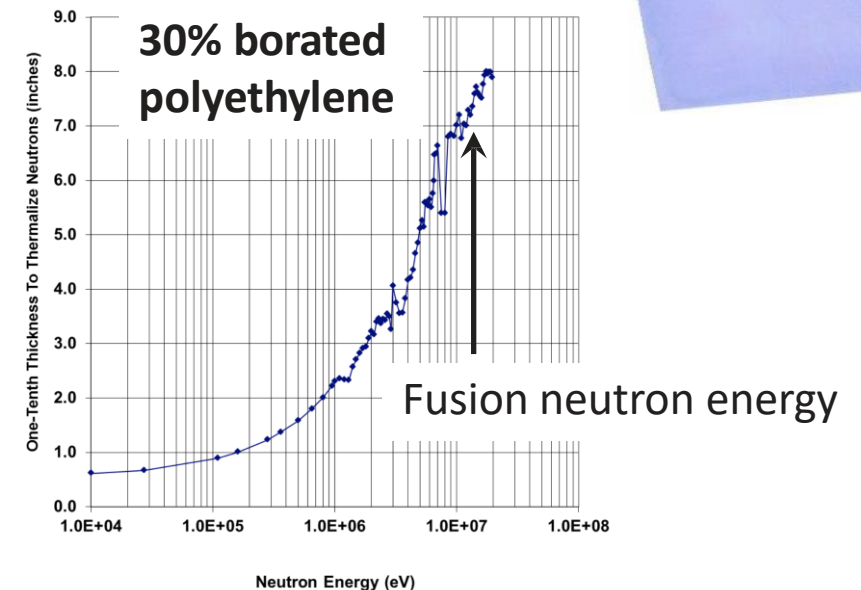
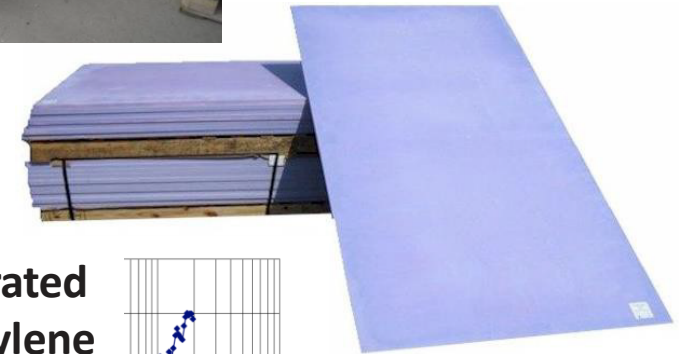



Fusion waste disposal works with existing regulations

- Four existing low level waste disposal facilities in the US provide sufficient solutions
- Low level radioactive waste disposed of in accordance with existing NRC requirements
- Decay in Storage when applicable can be done (NUREG-1556, Vol. 21, Appendix M)
- Interim storage facilities and equipment for both low-level dry active waste products as well as higher activity tokamak components
- Means to handle components in storage, allow for decay prior to reuse/repair or packaging and disposal, and allow for periodic inspection and detritiation
- Process controls to ensure that the final waste product meets the acceptance criteria of its intended long-term disposal site



Tungsten vacuum vessel wall produces 100x less dust and retains 100x less tritium than a carbon wall

- Source term is dominated by tritium adsorbed on the torus walls with smaller contributions from in-vessel tritium during a pulse and tritium adsorbed on dust particles
- Tungsten wall provides $\sim 100x$ less dust than carbon wall systems (which most of the published literature is based on), JET produced $\sim 1-2$ g from an entire operational campaign with new ITER type wall
 - Source: M. Rubel, et al., “Dust generation in tokamaks: Overview of beryllium and tungsten dust characterization in JET with the ITER-like wall,” Fusion Engineering and Design 136 (2018) 579-586.
- Tungsten dust also retains $\sim 100x$ less tritium than carbon dust
 - Source: T. Otsuka, et al., “Tritium retention characteristics in dust particles in JET with ITER-like wall,” Nuclear Materials and Energy, 17 (2018) 279-283

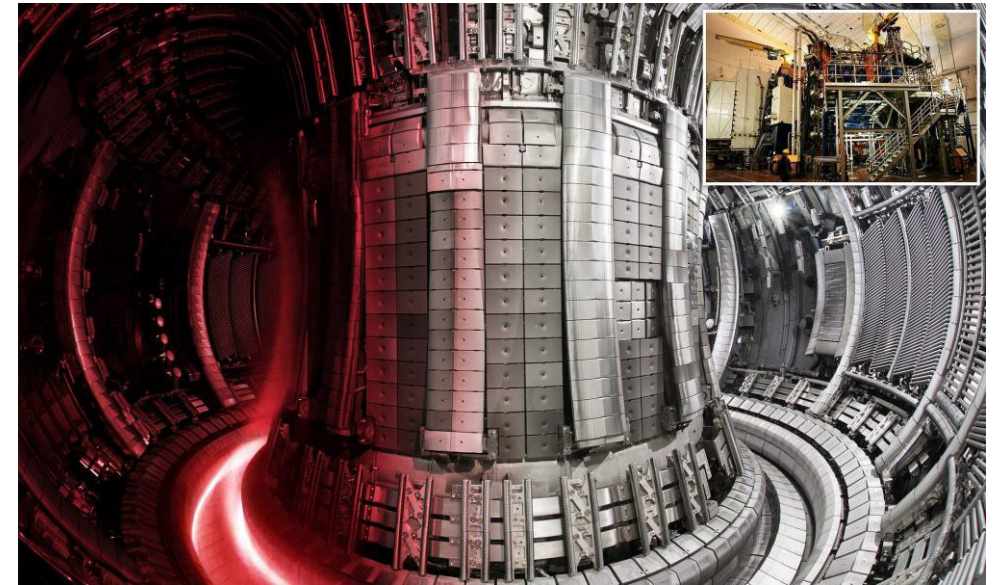



Loss of vacuum is the licensing basis event for tokamaks

- Loss of vacuum is likely to be the licensing basis event for a tokamak
- The vacuum vessel is under a vacuum, a hole initiates the event, air rushes in, not out
 - This is the opposite of fission systems which contain radionuclides under pressure and are forced out in case of a rupture
- After the torus air balances with the torus hall air, tritium may slowly diffuse out over time, providing ample time to take corrective action
- If the trace tritium recovery system is operational, all released tritium will be collected resulting in negligible emissions to the environment





Low off-site doses from a licensing basis event suggests ARC is unlikely to need any active safety grade systems

- For this unreviewed estimation, assume a loss of vacuum event and do not take credit for the trace tritium recovery system
- ARC total inventory at any one time 900,000 Ci (90 grams)
- Assume half of the total tritium inventory (45 grams) is adsorbed in the torus wall
 - This amount of tritium on the walls is dictated by operational control and is much more than what would be allowed by internal administrative procedures
- Conservative torus wall release fraction of 30% (13.5 grams)
 - Based on the best release fraction JET achieved under optimal venting conditions. Source: P. Andrew, et al., "Tritium retention and clean-up in JET," Fusion Engineering and Design, Vol 47, p. 233-245, 1999.
 - JET was licensed assuming a 10% release fraction in their design basis. Source: A. Bell, "The Safety Case for JET -T Operation," JET-P, p. P(99)07, 1999.
- Tritium is released in the form of HT, not HTO, and 10% of HT converts to HTO (1.35 grams)
 - Source: P. Ebey, "Conversion of tritium gas into tritiated water (HTO)," LA-UR-01-1825, LANL
 - Essentially no radiological significance for HT form of tritium (1/20,000 of HTO dose)
- HOTSPOT assumptions per NUREG-1140: no credit for any active mitigation, building release at 10 meters elevation of building roof, stability class F, wind speed of 1 meter per second
- HOTSPOT results: maximum dose of 370 mrem at 500 meters (location of the maximum dose not necessarily the site boundary)



Summary

- CFS's tritium handling system design is based on decades of successful operating history
- Fusion facilities can be effectively shielded using existing solutions
- LLW disposal can be accomplished with existing NRC regulations
- A very conservative loss of vacuum event for ARC results in doses below the 1000 mrem limit at the site boundary which means:
 - No need for any active safety grade systems and
 - No need for off-site emergency evacuation response
- CFS believes the current byproduct material regulatory model (10 CFR 30) is sufficient to ensure a safe and cost-effective fusion energy industry



The fastest path to
limitless, clean energy



Agenda

Time	Topic	Speaker
1:00 pm	Introductions	NRC
1:15 pm	Identification and Characterization of Fusion Hazards	Dr. Patrick White
2:15 pm	Overview of Fusion Industry Association Member Company Commercial Device Operational & Off-Normal Safety Case	Andrew Holland, Fusion Industry Association & Derek Sutherland, CT Fusion
3:30 pm	Break	
3:40 pm	Overview of Tritium Handling Systems	Tyler Ellis, Commonwealth Fusion Systems
4:25 pm	Supplemental Discussion of the Helion Device Safety Case	David Kirtley, Helion Energy
4:55 pm	Question and Answer Period	
5:30 pm	Adjourn	

Helion Energy: Supplemental Safety Case Analysis

March 23, 2022



Outline

- **Device Overview**
- **Operational Safety**
- **Accident Analysis**



Device Overview

How Helion Works

Magneto-Inertial Fusion

- Two toroidal plasmas (FRCs) are accelerated from opposite ends of the accelerator.
- They collide supersonically and are adiabatically compressed by a magnetic field to fusion conditions.
- Process is 100 microseconds, enables 1-10 Hz pulses.

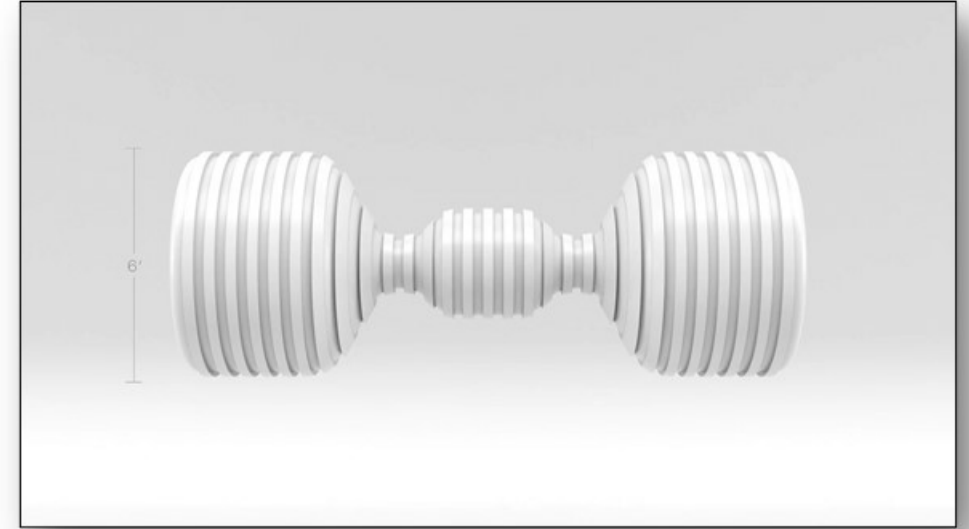

Non-Ignition Fusion

- Uses D-³He fuel (~95% fusion energy released as charged particles, only ~5% in neutrons).
- Energy is recaptured through magnetic fields and recycled in capacitor bank—enabling deployment at Q<2.

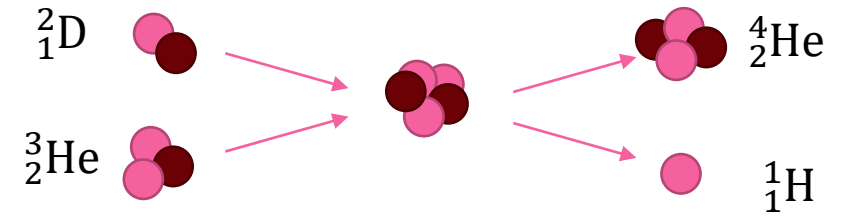
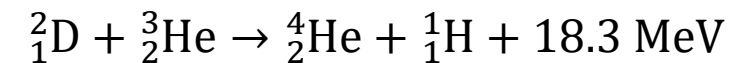

Scale & Manufacturability

- Device composed entirely of manufactured components
- Shielding also can be constructed separately and shipped to site
- No moving parts except valves

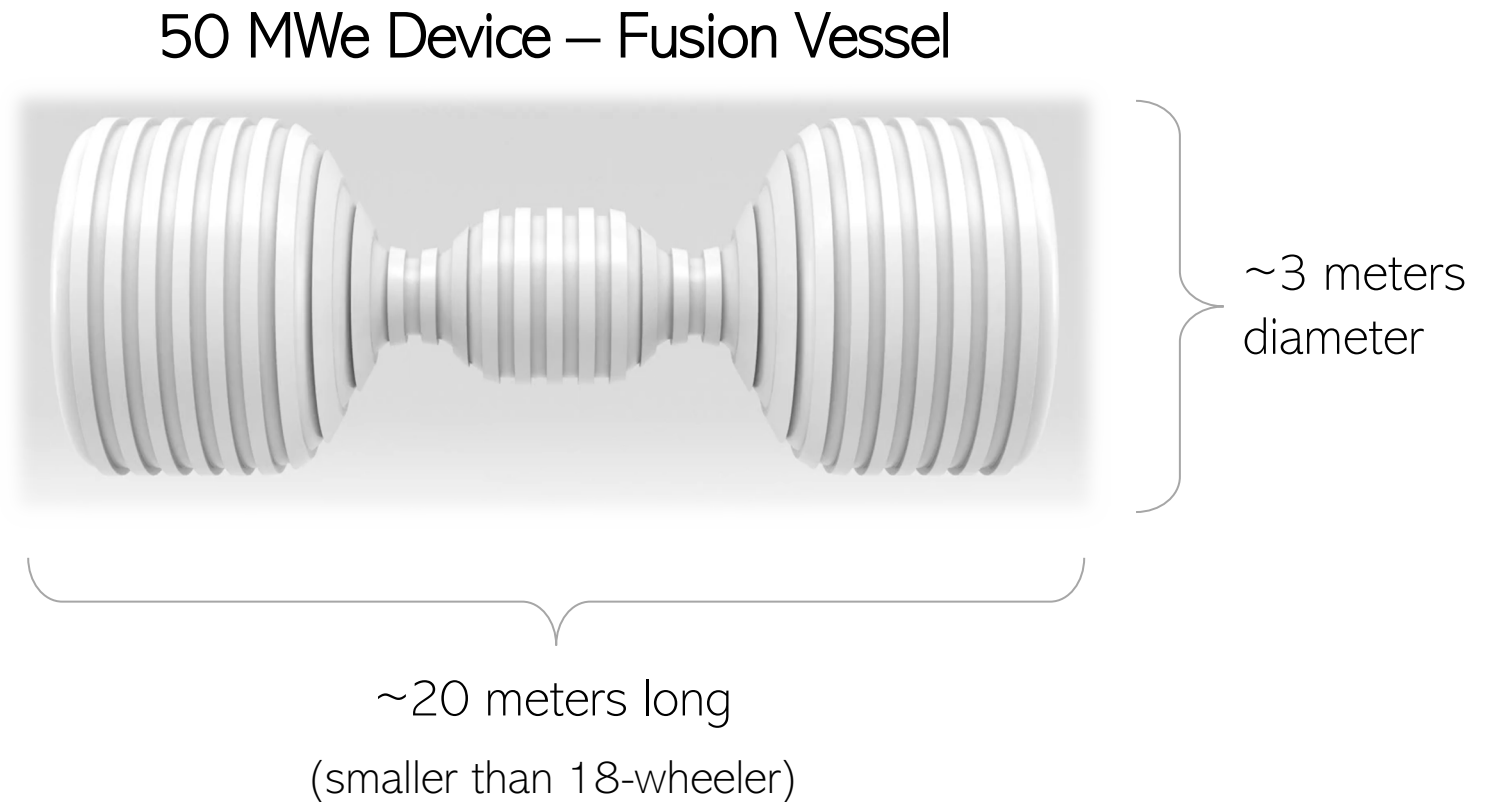

Characteristics of Helion's 50 MW Generator

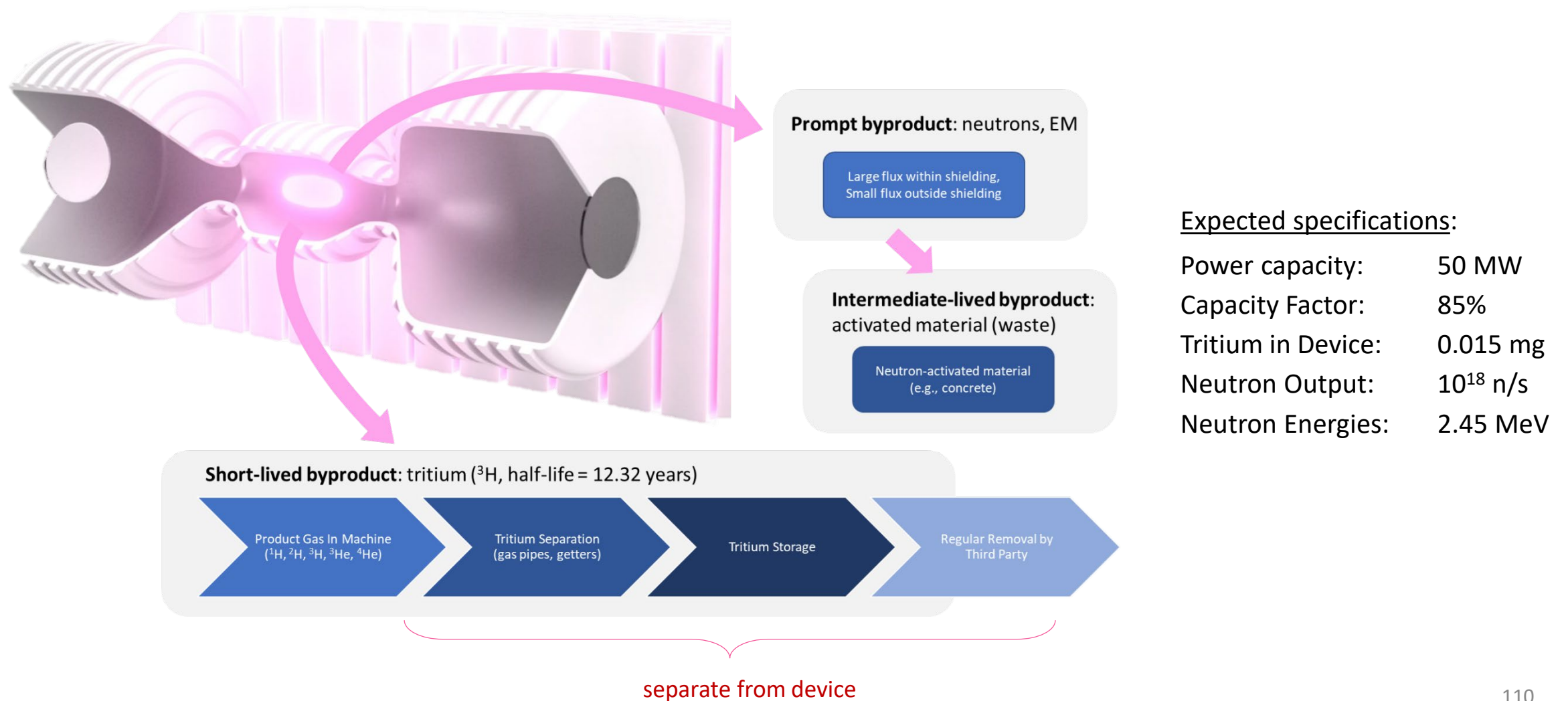

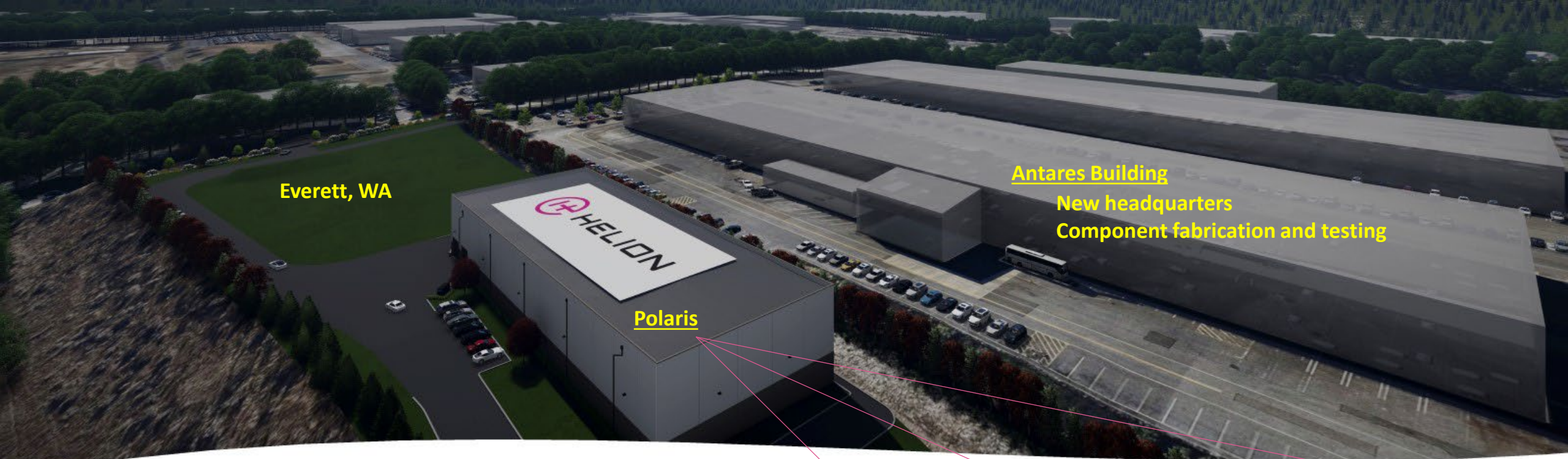

Everett, WA

Antares Building

New headquarters

Component fabrication and testing

Polaris

Polaris

- Helion's 7th generation facility
- Groundbreaking: July 2021
- *Net Electricity Demonstration: 2024*

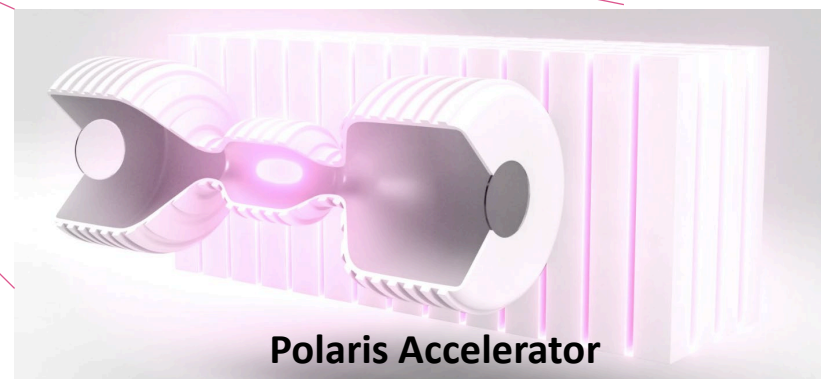

Polaris Accelerator

Operational Safety

Fusion During Operation

Fusion Device

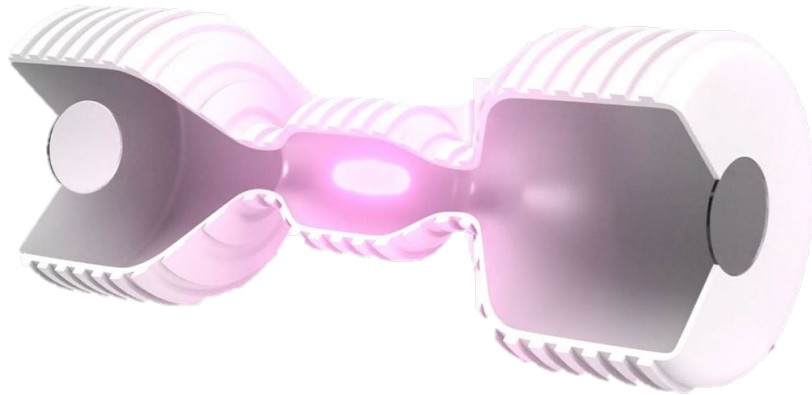

- Neutron and photon radiation
- In-process fuel/accelerated particles and exhaust
- Activated shielding

Accelerator (inc. Cyclotron)

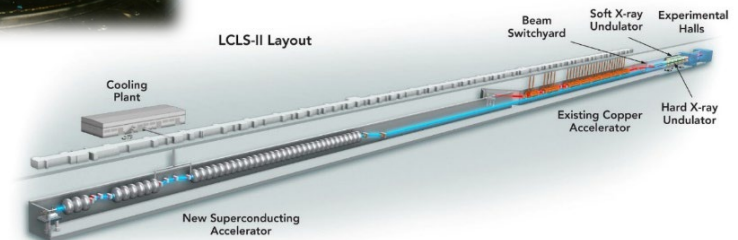

- Neutron and photon radiation
- In-process fuel/accelerated particles and exhaust
- Activated shielding

Key Concept: Fusion's operational impacts are fundamentally similar to that of a particle accelerator.

Particle Accelerators are Common

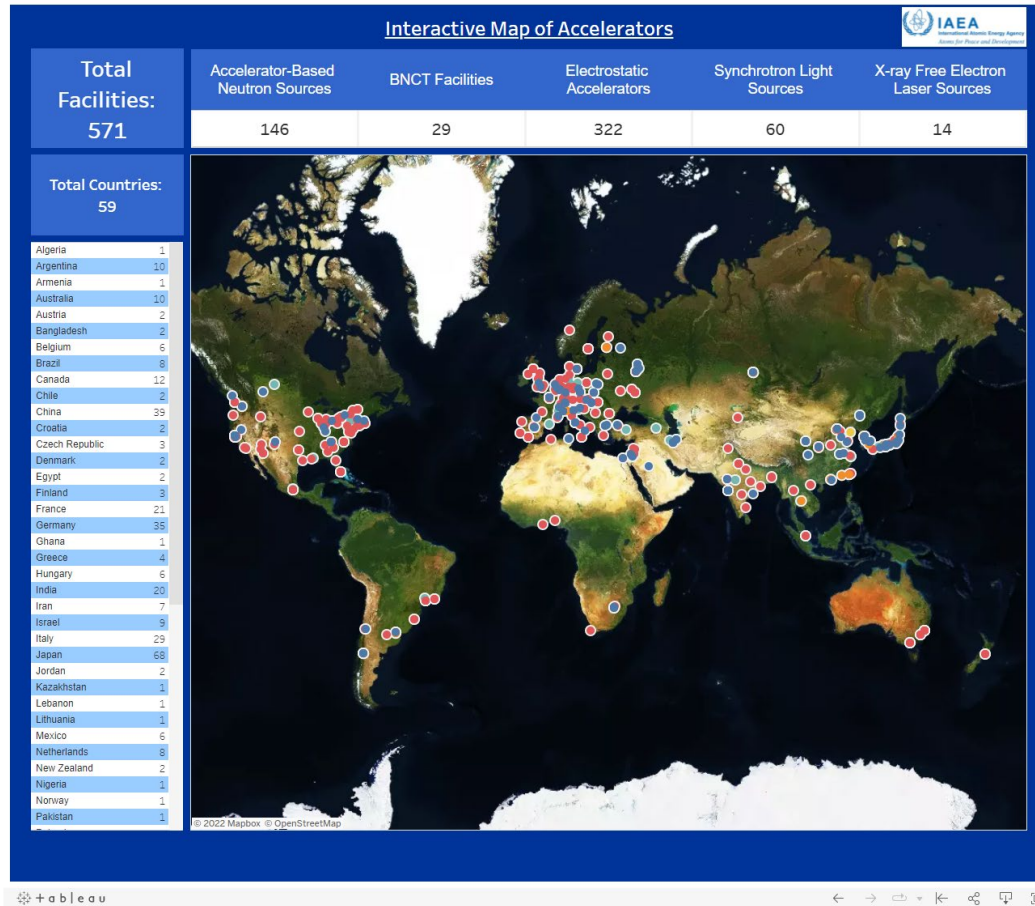

IAEA Website: <https://nucleus.iaea.org/sites/accelerators/Pages/default.aspx>

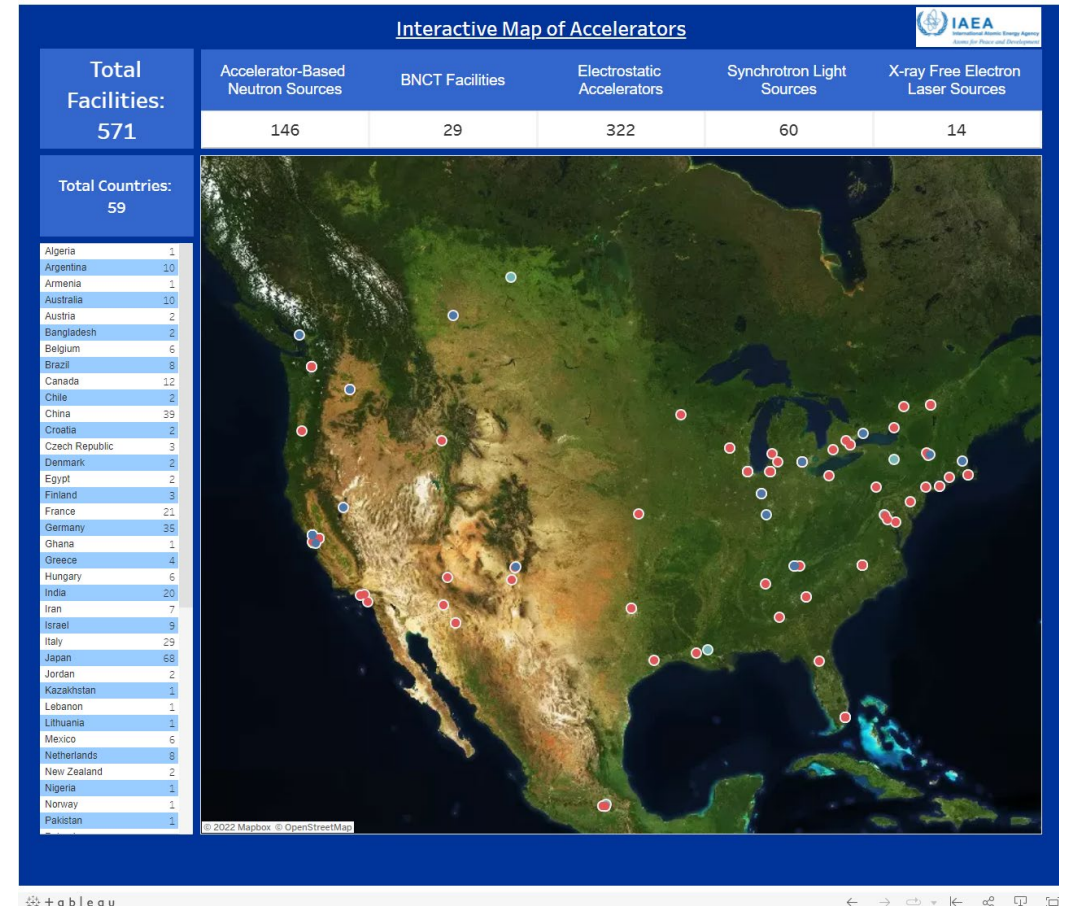

Broad federal & state experience regulating such devices

Helion Commercial Neutron Shielding

- Neutron dose attenuated by a passive shielding vault.
- Only ~5% D-³He fusion output in neutrons (2.45 MeV)
- Shielding similar in size to commercial accelerators
- *Regulatory Precedent.* Part 36 // §36.25 Shielding
(e.g., 2 mrem/hr dose limit following shielding)

§ 36.25 Shielding.

(a) The radiation dose rate in areas that are normally occupied during operation of a panoramic irradiator may not exceed 0.02 millisievert (2 millirems) per hour at any location 30 centimeters or more from the wall of the room when the sources are exposed. The dose rate must be averaged over an area not to exceed 100 square centimeters having no linear dimension greater than 20 cm. Areas where the radiation dose rate exceeds 0.02 millisievert (2 millirems) per hour must be locked, roped off, or posted.

(b) The radiation dose at 30 centimeters over the edge of the pool of a pool irradiator may not exceed 0.02 millisievert (2 millirems) per hour when the sources are in the fully shielded position.

(c) The radiation dose rate at 1 meter from the shield of a dry-source-storage panoramic irradiator when the source is shielded may not exceed 0.02 millisievert (2 millirems) per hour and at 5 centimeters from the shield may not exceed 0.2 millisievert (20 millirems) per hour.

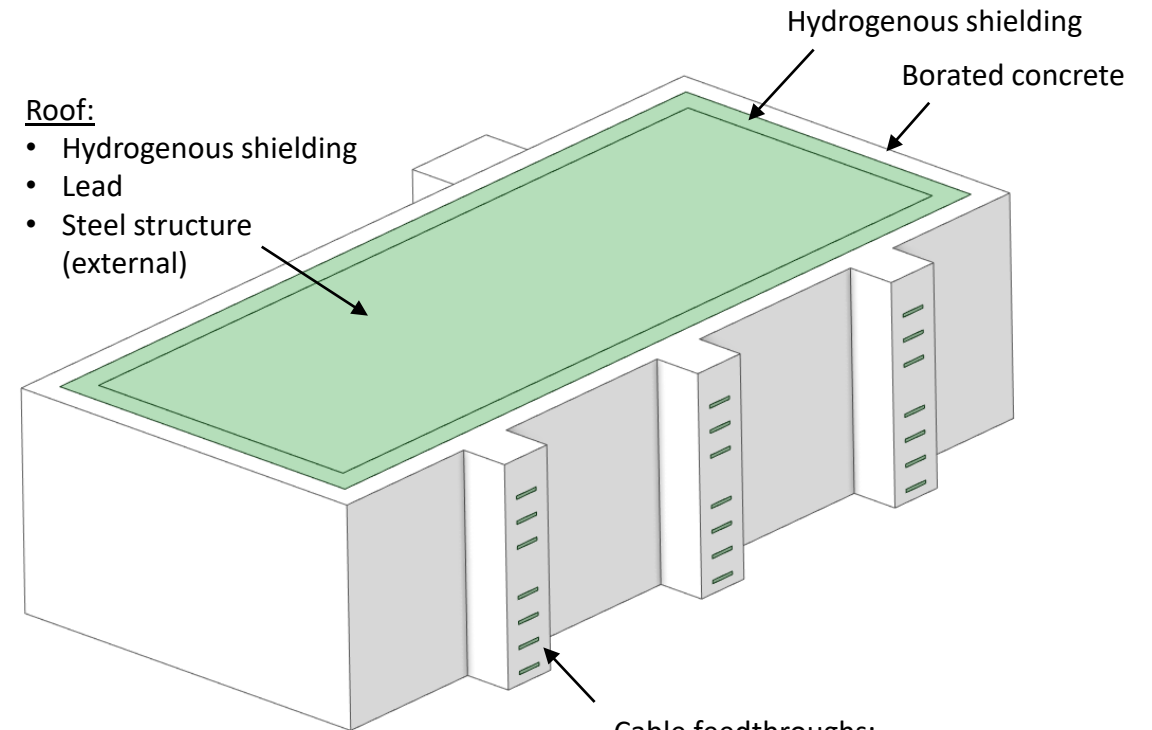

Roof:

- Hydrogenous shielding
- Lead
- Steel structure (external)

Cable feedthroughs:

- Filled with cable, or
- Plugged with hydrogenous shielding

Shielding thickness anticipated to be less than two meters.

No Post-Shutdown Cooling Required

50 MW Device Metric	1 hour	1 day	1 week	1 year
Driving Device Inventory*	44 kCi/m ³	8 kCi/m ³	275 Ci/m ³	< 1 Ci/m ³
Device Latent Heat	40 W/m ³	6.5 W/m ³	<< 1 W/m ³	<< 1 W/m ³
Cumulative Temp. Increase**	7 C	18 C	6 C	≈0 C
Dose at Machine Surface	4 rem/hr	0.2 rem/hr	4 mrem/hr	0.004 μrem/hr

*Driver: activated aluminum (Al-28, 2.3-minute half life)

**Assume 5 W/m² convective cooling

Latent Heating

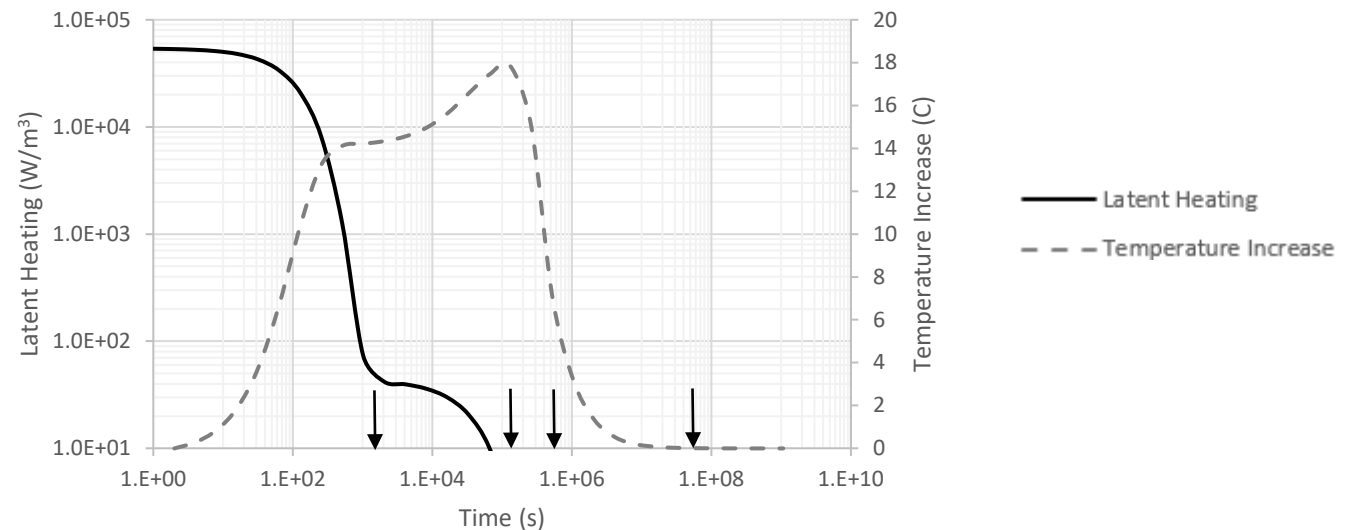

Key Concept:

- Enables a shutdown scenario similar to industrial facilities and particle accelerators.
- Activation products cool rapidly, in comparison to spent nuclear fission fuel.

Accident Analysis

Subject of Analysis

Helion 50MW Facility – Basic Layout

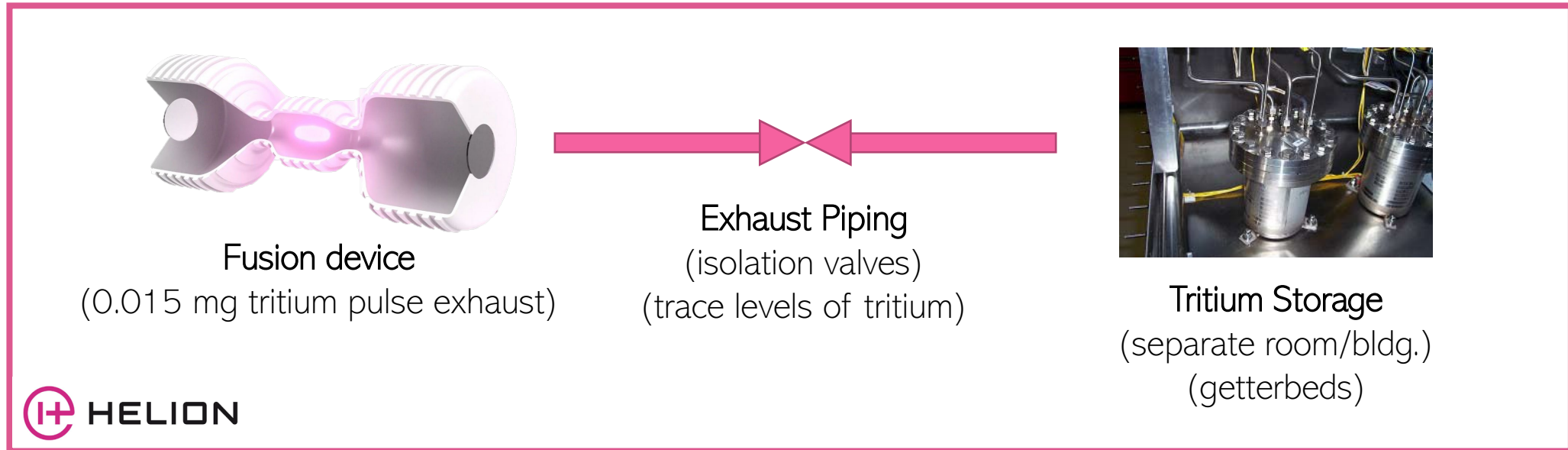

Key Concepts:

- Tritium can be separated from the Helion device and addressed as separate materials handling issue.
- Enables analysis to focus on the (fixed & limited) inventory within the fusion device.

Simplified Device Release Analysis

- **Simplified Analysis** (extreme hypothetical):
 - All tritium gas released and converted to HTO (~ 0.015 mg)
 - Entire vacuum vessel wall turned to dust
- **Tritium Release Evaluation:**
 - 0.015 mg → 4.0 μ rem (max value at 470m)
- **Dust Release Evaluation:**
 - Primary dust concern: ^{31}Si created w/ 2.45 MeV neutrons
 - Dust equilibrium: 190 Ci in hours (2.6 hr. half life, 1.27 MeV γ)
 - Vacuum chamber wall → 11.3 mrem (max value at 460m)
- Physically realistic impacts would be much less.

Analytical Tools

- Release Mapping – HotSpot v.3.1.2
- Dust Activation Rate Analysis – MCNP6.2

Silica Dust Profile

Table 1
Relevant reactions for 14 MeV and thermal neutrons

Reaction	Abund. %	$\sigma_{14\text{ MeV or thermal, mb}}$	E_T , MeV	σ , mb	E_{eff} , MeV	σ_0 , mb	Half-life	Gamma energy, MeV
$^{28}\text{Si}(n, p)^{28}\text{Al}$	92.2	250	4.01	4.0			2.3 m	1.78(100%)
$^{29}\text{Si}(n, p)^{29}\text{Al}$	4.7	100	3.1	2.7			6.52 m	1.28(91%)
$^{30}\text{Si}(n, p)^{30}\text{Al}$	3.1	60	~8				0.05 m	2.23(61%)
$^{30}\text{Si}(n, \gamma)^{31}\text{Si}$	3.1	110 _{th}					2.6 h	1.27(07%)

H. Sorek, H.C. Griffin, "Fast Neutron Activation Analysis of Silicon in Aluminum Alloys," *Journal of Rad. Chemistry*, **79**, 1, 1983.

Key Takeaway: Device impacts are fundamentally limited compared to fission systems, and akin to industrial facilities.

Fusion Tritium Cycle for Alternative Fuels

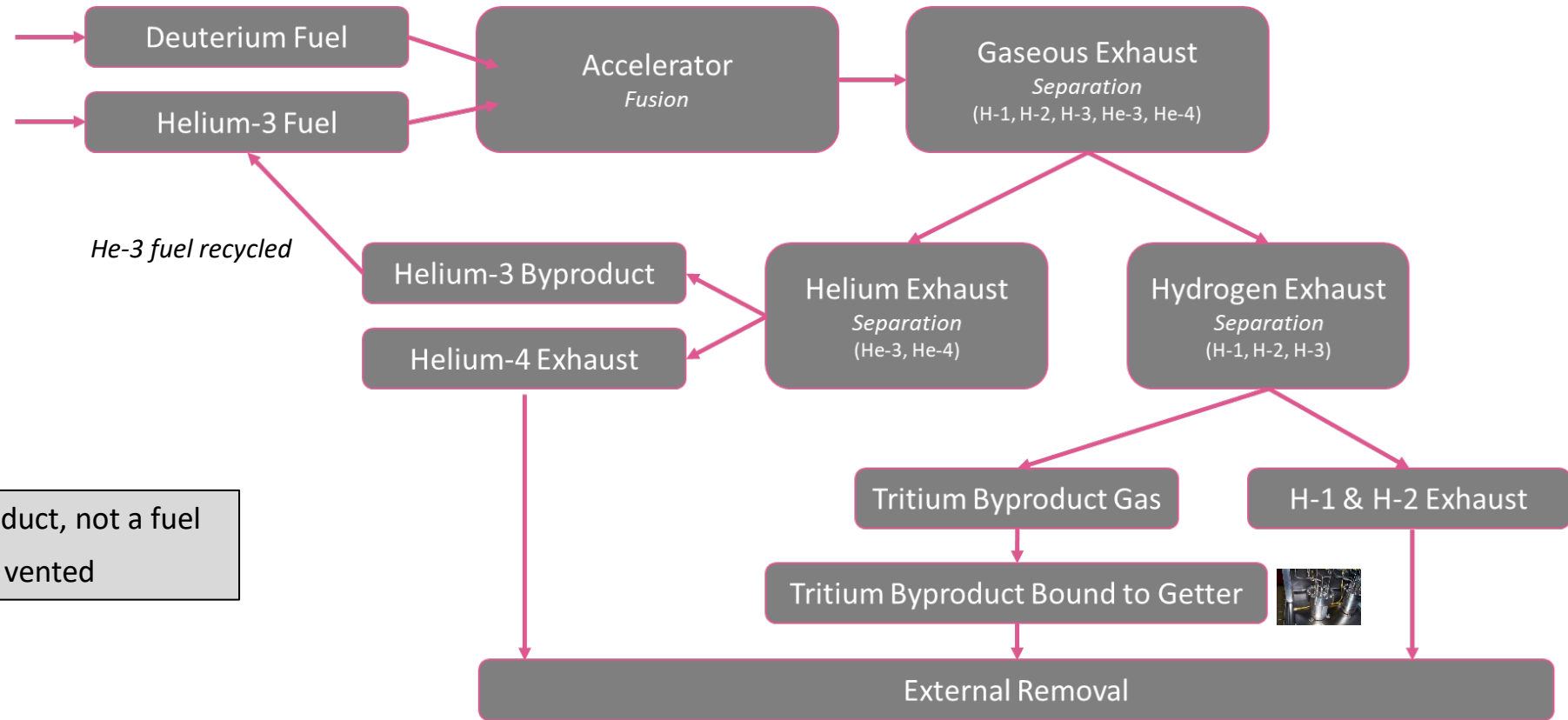

- Tritium is a byproduct, not a fuel
- Tritium gas is not vented

Summary

From a technical perspective, fusion device impacts are far more akin to a particle accelerator or industrial facility than a fission reactor.

Operational Impacts

- Impacts profile identical to particle accelerator.
- Addressed through common shielding practices.
- No need for active cooling on shutdown.

Accident Impacts

-
- The device is the unique consideration; stored tritium is a standard radioactive materials management issue.
 - Tritium & dust release concerns are consistent with industrial facilities.

Questions & Next Steps

- How can we best assist the NRC?
- What additional information would help?



HELION

Limitless clean energy, powered by fusion.

Agenda

Time	Topic	Speaker
1:00 pm	Introductions	NRC
1:15 pm	Identification and Characterization of Fusion Hazards	Dr. Patrick White
2:15 pm	Overview of Fusion Industry Association Member Company Commercial Device Operational & Off-Normal Safety Case	Andrew Holland, Fusion Industry Association & Derek Sutherland, CT Fusion
3:30 pm	Break	
3:40 pm	Overview of Tritium Handling Systems	Tyler Ellis, Commonwealth Fusion Systems
4:25 pm	Supplemental Discussion of the Helion Device Safety Case	David Kirtley, Helion Energy
4:55 pm	Question and Answer Period	
5:30 pm	Adjourn	



Questions and Wrap-up

A blurred background image showing several people in a meeting room. One person in the center is pointing towards a screen or whiteboard. The scene is brightly lit, possibly from a window, creating a soft, out-of-focus effect.

Thank You!