

SCALE & MELCOR
non-LWR Fuel Cycle Demonstration Project –
High Temperature Gas-Cooled Reactors

NRC's Volume 5 – Public Workshop #1

February 28, 2023

*U.S. Nuclear Regulatory Commission
Office of Nuclear Regulatory Research
Office of Nuclear Material Safety and Safeguards
Office of Nuclear Reactor Regulations*

Outline

- *NRC Strategy for non-LWRs Readiness*
- *Project Scope*
- *HTGR Nuclear Fuel Cycle*
- *Overview of the Simulated Accidents*
- *Nuclide inventory, decay heat, and criticality calculations in SCALE*
- *High-Temperature Gas-Cooled Reactor Modeling using MELCOR*
- *Summary & Closing Thoughts*

NRC's Strategy for Preparing for non-LWRs

- **NRC's Readiness Strategy for Non-LWRs**

- Phase 1 – Vision & Strategy
- Phase 2 – Implementation Action Plans



- **IAPs are planning tools that describe:**

- Required work, resources, and sequencing of work to achieve readiness

- **Strategy #2 – Computer Codes and Review Tools**

- Identifies computer code & development activities
- Identifies key phenomena
- Assess available experimental data & needs



What's in Volume 5?

What system(s) are we analyzing?

What code(s) are we using?

What are the key phenomena being considered?

Are there any gaps in modeling capabilities of the selected codes? How do we close these gaps?

What data do we have & what data do we need?

IAP Strategy 2
Volume 5

U.S.NRC
United States Nuclear Regulatory Commission
Protecting People and the Environment

REVISION 1
MARCH 31, 2021

NRC Non-Light Water Reactor (Non-LWR) Vision and Strategy, Volume 5 – Radionuclide Characterization, Criticality, Shielding, and Transport in the Nuclear Fuel Cycle



Technical Readiness
Regulatory Readiness
Communication

ML21088A047

LWR Nuclear Fuel Cycle

Regulations for the Nuclear Fuel Cycle

- Protects onsite workers, public and the environment against radiological and non-radiological hazards that arise from fuel cycle operations.
 - Radiation hazards
 - Radiological hazards
 - Non-radiological (chemical) hazards
- Applicable Regulations
 - Uranium Recovery / Milling – 10 CFR Part 20
 - Uranium Conversion – 10 CFR Parts 30, 40, 70, 73 and 76
 - Uranium Enrichment – 10 CFR Parts 30, 40, 70, 73 and 76
 - Fuel Fabrication – 10 CFR Parts 30, 40, 70, 73 and 76
 - Reactor Utilization – 10 CFR Parts 50 & 74
 - Spent Fuel Pool Storage – 10 CFR Parts 50.68
 - Spent Fuel Storage (Dry) – 10 CFR Parts 63, 71, and 72

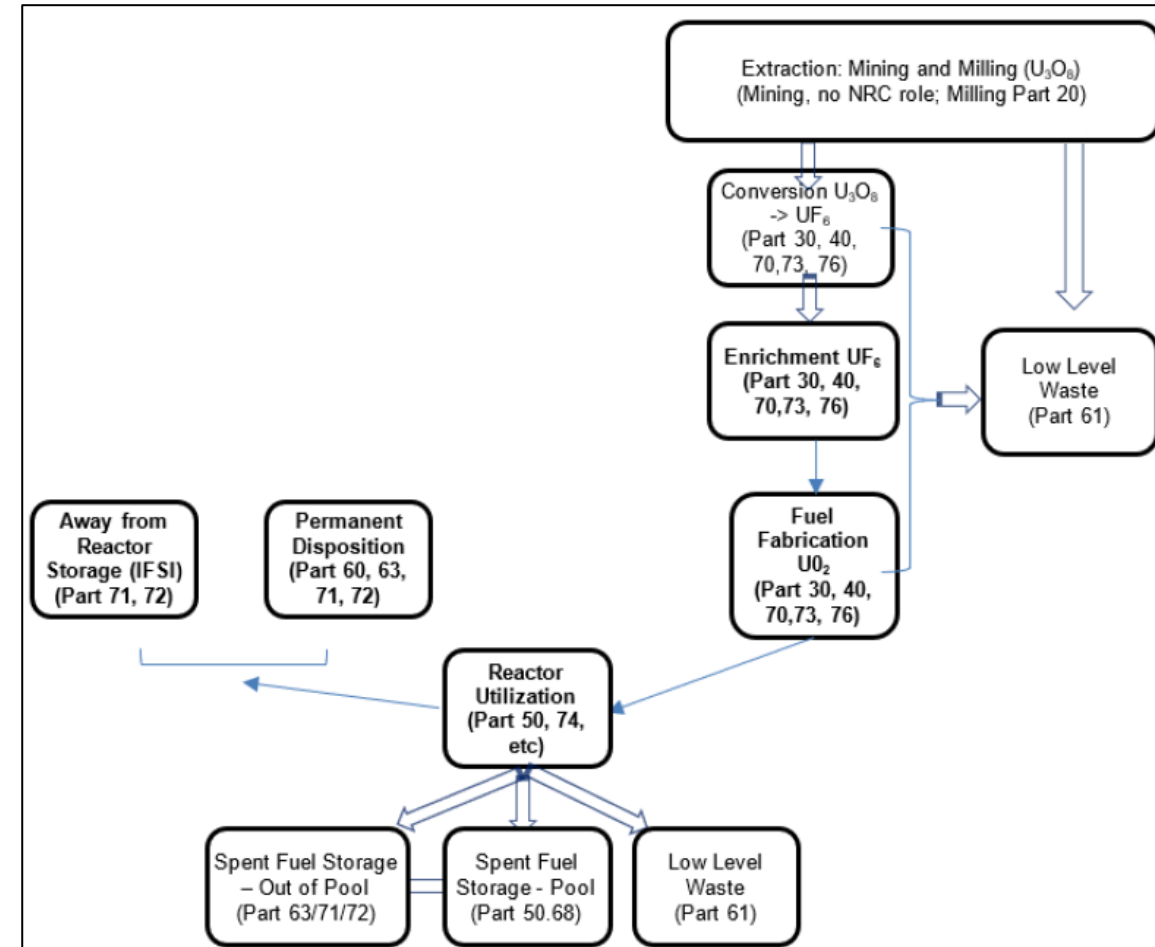

Project Scope - Non-LWR Fuel Cycle

- *Stages in scope for Volume 5*

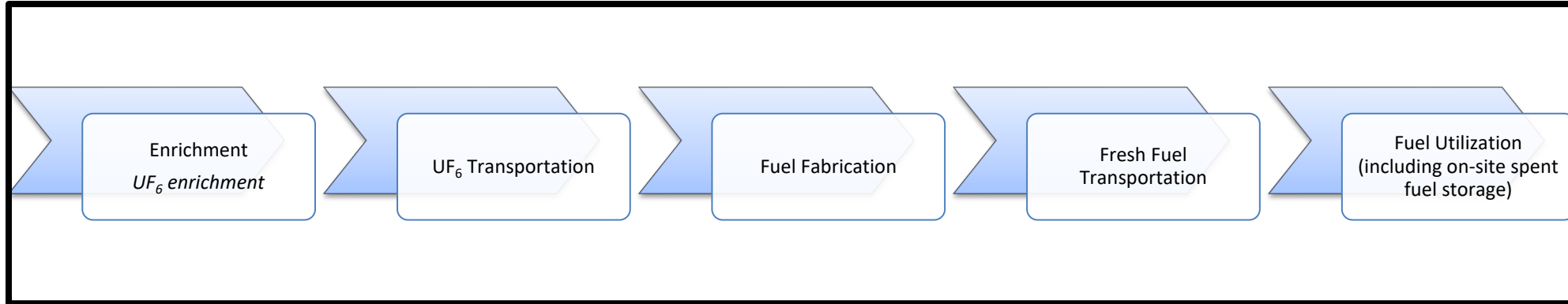

- *Stages out of scope for Volume 5*

Uranium Mining & Milling	• <i>Not envisioned to change from current methods.</i>
Power Production	• <i>Successfully completed and leveraged from the Volume 3 – Source Term & Consequence work</i>
Spent Fuel Off-site Storage & Transportation	• <i>Large amount of uncertainties for non-LWR concepts & lack of information</i>
Spent Fuel Final Disposal	• <i>Large amount of uncertainties for non-LWR concepts & lack of information</i>

Codes Supporting non-LWR Nuclear Fuel Cycle Licensing

OAK RIDGE
National Laboratory

scale



Sandia
National
Laboratories

MELCOR

- NRC's comprehensive neutronics package
 - Nuclear data & cross-section processing
 - Decay heat analyses
 - Criticality safety
 - Radiation shielding
 - Radionuclide inventory & depletion generation
 - Reactor core physics
 - Sensitivity and uncertainty analyses

- NRC's comprehensive accident progression and source term code
 - Characterizing and tracking accident progression,
 - Performing transport and deposition of radionuclides throughout a facility,
 - Performing non-radiological accident progression

Project Approach

- Build representative fuel cycle designs **leveraging** the Volume 3 designs
- Identify key scenarios and accidents exercising key phenomena & models
- Build representative SCALE & MELCOR models and evaluate

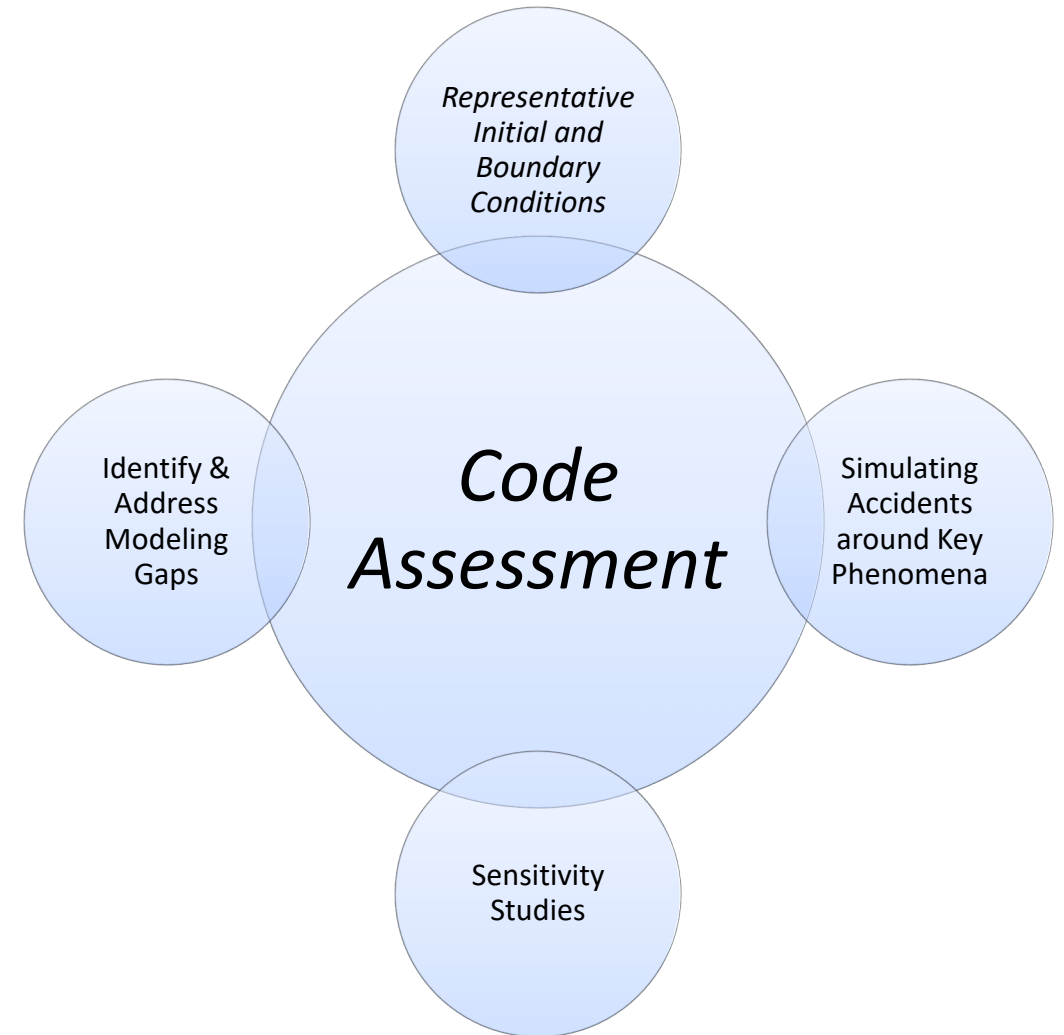

Representative Fuel Cycle Designs

- Completed 5 non-LWR fuel cycle designs for –
 - HPR – INL Design A
 - HTGR – PBMR-400
 - FHR – UCB Mark 1
 - MSR – MSRE
 - SFR - ABTR
- Identifies potential processes & methods, for example:
 - *What shipping package could transport HALEU-enriched UF₆? What are the hazards associated?*
 - *How is spent SFR fuel moved? What are the hazards associated?*
 - *How is fissile salt manufactured for MSRs? What are the various kinds of fissile salt that may be used? What are the hazards?*

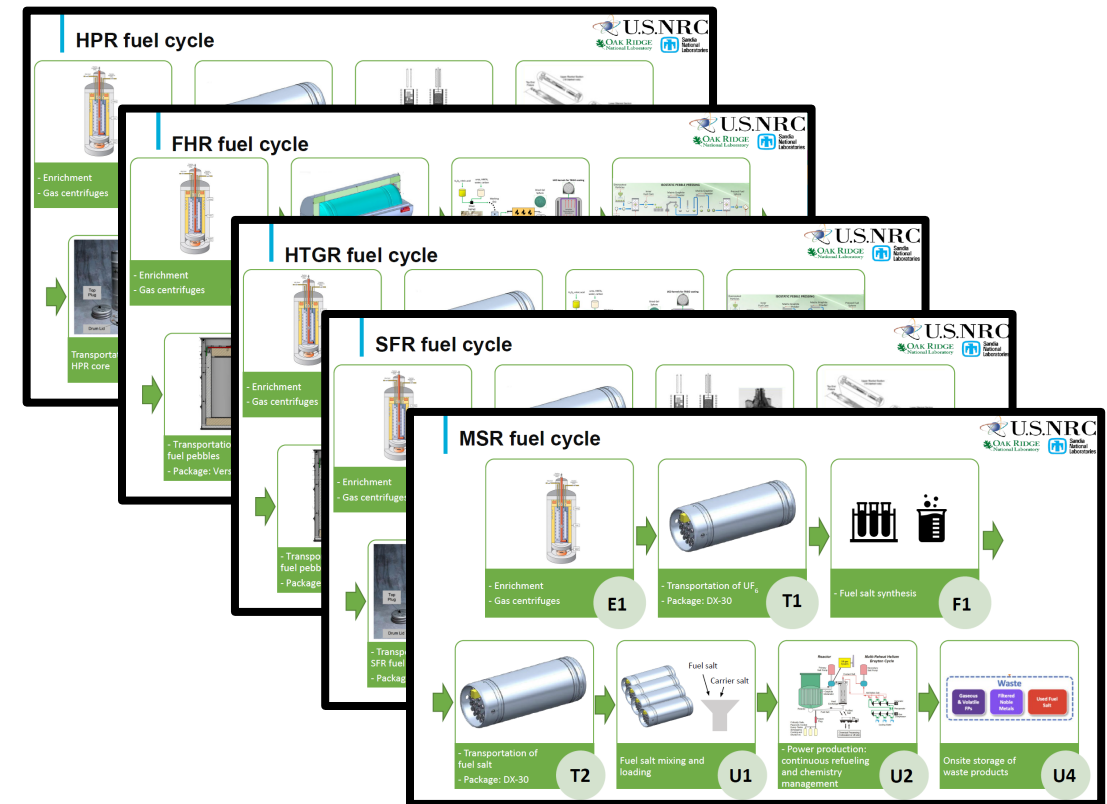

Prototypic Initial and Boundary Conditions for the SCALE & MELCOR Analyses

Overview of the HTGR fuel cycle

SCALE/MELCOR Non-Light-Water Reactor (Non-LWR)
Fuel Cycle Demonstration Project for a
High Temperature Gas-Cooled Reactor

NRC Public Workshop, February 28, 2023

F. Bostelmann, E. Davidson, W. Wieselquist



U.S. NRC

 **OAK RIDGE**
National Laboratory



Sandia
National
Laboratories

Overview

- Initial effort was to identify hazards across the HTGR fuel cycle
 - Determine details of the fuel cycle stage based on publicly available information
 - Use PBMR-400 as basis for fuel pebble details and for HTGR operation
 - Identify where additional data are needed or can benefit simulations
 - Identify potential hazards and accident scenarios for each stage of the fuel cycle
 - Identify accidents independently of their probability to occur
 - Select accident scenarios for SCALE/MELCOR to simulate under consideration of the project goal to demonstrate SCALE/MELCOR's capabilities
- Challenges encountered during the scenario development
 - Some stages of the HTGR fuel cycle are not yet developed
 - Many documents are proprietary

HTGR Fuel Cycle

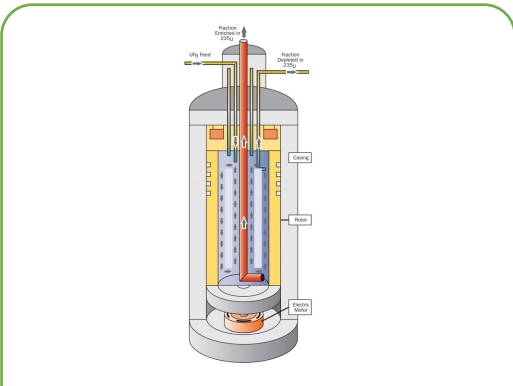

- Enrichment
- Gas centrifuges

E1

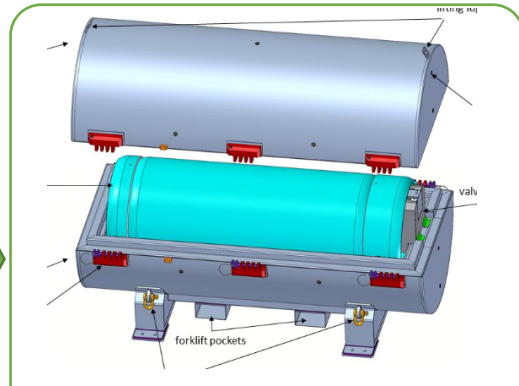

- Transportation of UF_6
- Package: DN30-X

T1

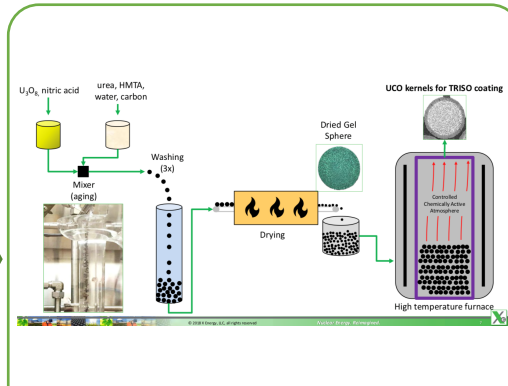

- TRISO fabrication
- Sol-gel process

F1

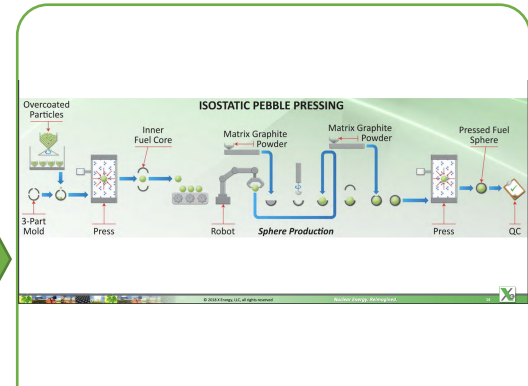

- Pebble fabrication
- Process: X-energy

F2

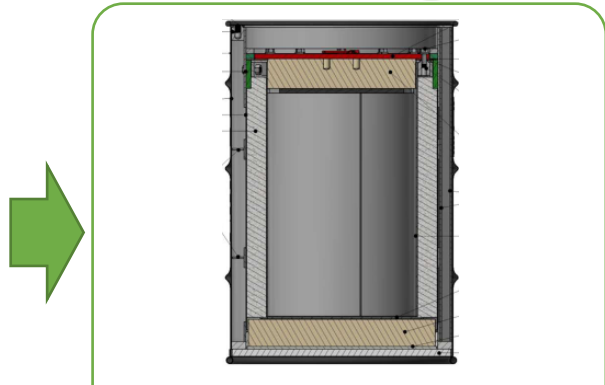

- Transportation of fuel pebbles
- Package: Versa-Pac

T2

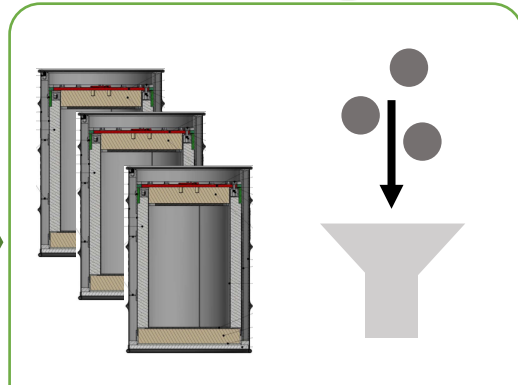

- Fresh fuel staging
- Pebble loading

U1

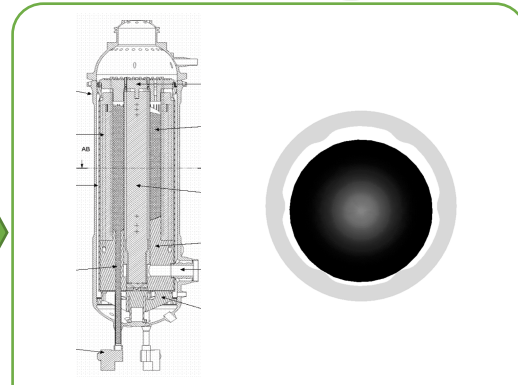

- Power production
- Online refueling

U2

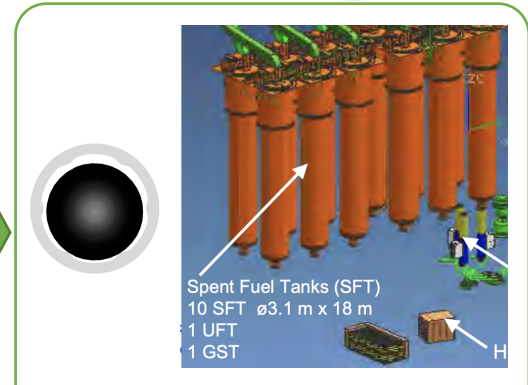

- Discharged pebble storage onsite
- Spent fuel/used fuel/graphite tanks

U4

Not covered: uranium mining & milling, spent fuel transportation & off-site storage & final disposal

E1: Enrichment

- Enrichment of UF_6 up to 19.75 wt% ^{235}U [High Assay Low Enriched Uranium (HALEU)]
- US facilities for uranium enrichment using gas centrifuges
 - Louisiana Energy Services (Urenco USA) in Eunice, NM
 - Currently the only active commercial process for enrichment of up to 5 wt% ^{235}U in the US
 - Centrus Energy Corp in Piketon, OH
 - First U.S. facility licensed for HALEU production
 - DOE program, initially started in 05/19, revised in 03/22
 - Phase 1 (~1 year): installation of HALEU cascade, demonstration of production of 20 kg UF_6 HALEU
 - Phase 2 (1 year): production of 900 kg UF_6 HALEU
 - Phase 3 (3 year): production of 900 kg UF_6 HALEU/year

Major hazards:

- UF_6 liquid and vapor leaks from damaged pipes or cylinders
- Criticality due to unintended accumulation of enriched U

T1: Transportation of UF₆

ORANO DN30-X package for up to 20 wt% ²³⁵U enrichment:

- License application under review by NRC
- 30B-X cylinder similar to 30B cylinder, but with criticality control system (addition of internal absorber structure)
- 30B cylinder: Licensed up to 5 wt.% ²³⁵U; permissible UF₆ mass of 2277 kg
- Permissible mass in DN30-X depends on enrichment (proposed):

Package design	Enrichment limit	Permissible UF ₆ mass
DN30-10	10 wt.% ²³⁵ U	1460 kg
DN30-20	20 wt.% ²³⁵ U	1271 kg

- DN30-X protective structural packaging (PSP) unchanged to DN30: outer PSP acts as a shock absorber during drop tests and as thermal protection in fire tests

Major hazards:

- Criticality due to water accidents and container drop
- Release of UF₆ due to container rupture

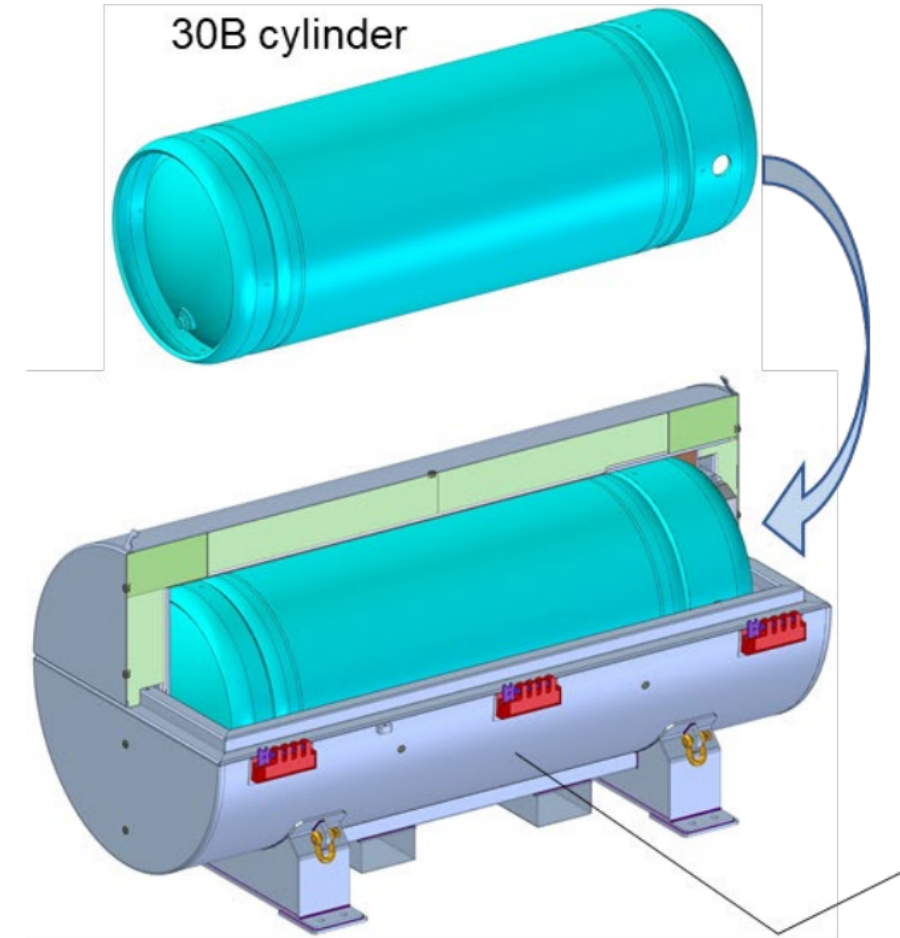

DN30 PSP

ORANO: 30B cylinder with DN30 PSP

F1: Fabrication of TRISO Particles

Fuel kernel:

- U.S. TRISO production based on internal sol-gel process
- Starting sol is a uranyl nitrate solution
- Sol is dripped through a nozzle into a heated organic diluent (silicone oil)
- Heat causes HMTA (Hexamethylenetetramine) to chemically decompose and induces a gelation reaction which eventually forms the fuel kernel

Kernel coating:

- Coat the kernels with the carbon layers using various gas mixtures at different temperatures

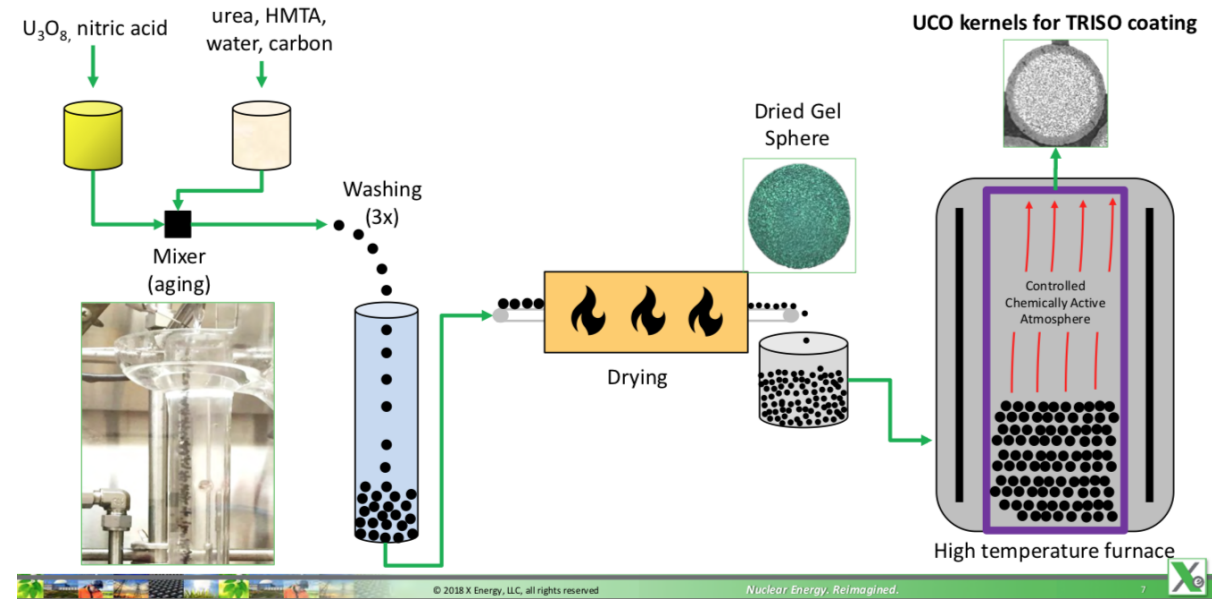

Ref.: P. Pappano, "TRISO-X Fuel Fabrication Facility Overview," Introductory Meeting with the NRC, ML18254A086 (2018). <https://www.nrc.gov/docs/ML1825/ML18254A086.pdf>

Table 1: Typical gas mixtures and temperatures used for TRISO coating.

Coating layer	Gas Mixture	Temperature (°C)
Buffer	Ar + C ₂ H ₂	1400-1500
IPyC	Ar + C ₂ H ₂ + C ₃ H ₆	1250-1350
SiC	Ar + H ₂ + MTS	1400-1500
OPyC	Ar + C ₂ H ₂ + C ₃ H ₆	1250-1350

Ref.: R. L. Seibert, et al., "Production and characterization of TRISO fuel particles with multilayered SiC," Journal of Nuclear Materials, 515, pp. 215-226 (2019).

Major hazards:

- Hazards from the use of the various chemicals (spills, reaction with water, fire, explosion)
- Criticality due to improper storage of UF₆ or water accidents

F2: Fabrication of Fuel Pebbles

- Graphite powder is dried, pulverized and then is used for overcoating the TRISO kernels at controlled temperatures
- Pre-press overcoated TRISOs onto inner graphite sphere
- Final pressing of entire pebble which includes outer non-fuel region followed by some steps before pebble is released for inspection¹

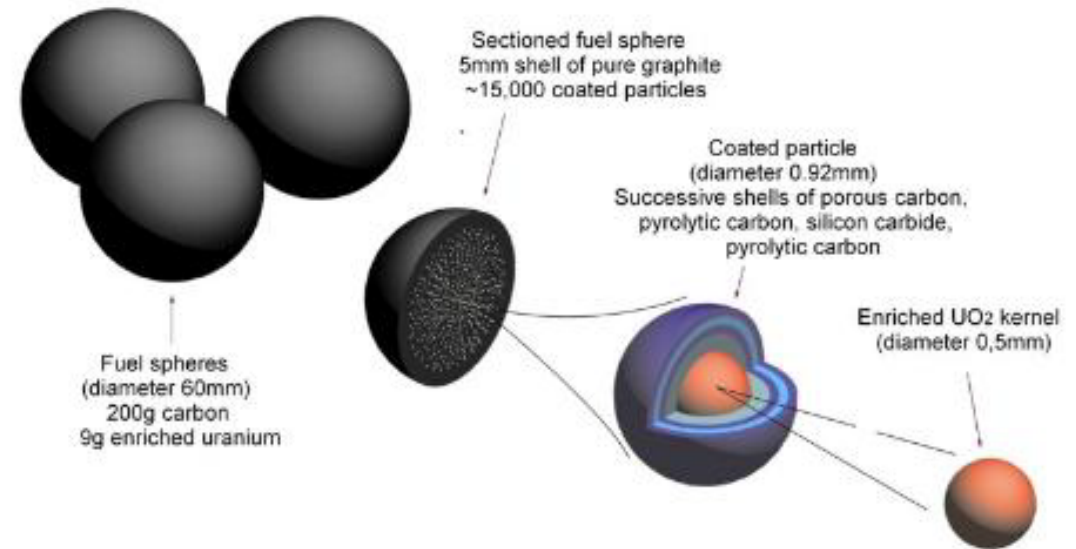

PBMR-400 fuel pebble and TRISO particle²

Major hazards:

- Criticality due to improper storage of TRISOs or fuel pebbles
- Contact with water leading to graphite corrosion
- Development of graphite dust leading to fire hazard

Ref 1: IAEA, "Fuel performance and fission product behavior," IAEA-TECDOC-978 (1997).

Ref 2: "PBMR Coupled Neutronics / Thermal-hydraulics Transient Benchmark The PBMR-400 Core Design, Vol. 1: The Benchmark Definition," NEA/NSC/DOC(2013)10, 2013.

T2: Transportation of Fresh Fuel Pebbles

Versa-Pac:

- Package for shipping of of fuel pebbles and storage at the plant
- Versa-Pac is licensed for enrichments up to 100% ²³⁵U
- Maximum allowed mass determined by enrichment:

Enrichment [wt.%]	²³⁵ U mass limit [g]
≤100	360
≤20	445
≤10	505
≤5	610
≤1.25	1650

→ 584 PBMR-400 pebbles with 9.6 wt% ²³⁵U enrichment

Major hazards:

- Criticality due to water accidents and container drop
- Contact with water leading to graphite corrosion
- Development of graphite dust leading to fire hazard

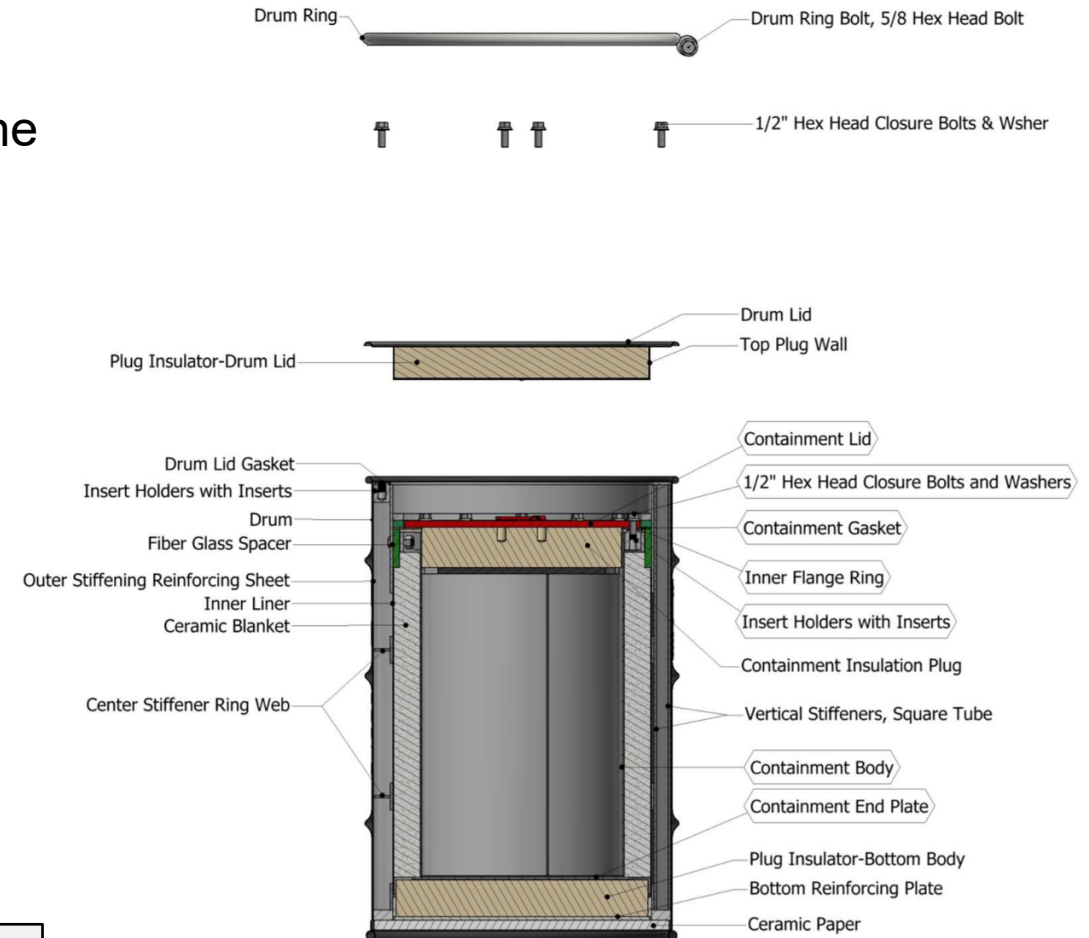

Versa-Pac

U1/U2/U4 – Utilization Stages

Reference: PBMR-400

- Daily fuel pebble circulation: **2,900** pebbles
- Average number of passes per fuel pebble: 6
- Number of fresh fuel pebbles loaded per day: **483**
 - 25 fuel pebble canisters per month if canister loaded to ^{235}U limit
 - 40 VP-55 canisters per month according to our model (see SCALE slides)
- Plant lifetime: 40 years
- Total number of fuel pebbles during lifetime, considering 6 overhauls: 6,969,667
- Target burnup: **90 GWd/tHM**
- Fuel enrichment: **9.6 wt% ^{235}U**
- Total pebble loading in core: **451,530** pebbles (start-up core: 2/3 graphite pebbles)
- Pebble handling via Fuel Handling and Storage System (FHSS)

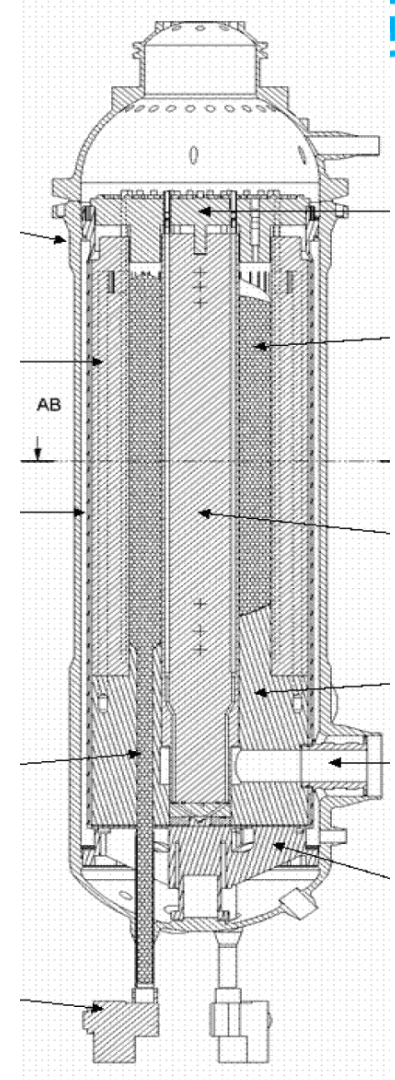

PBMR-400

U1: Fresh Fuel Staging and Loading

- Fresh pebbles stored in Versa-Pac containers
- Pebbles are fed into system via hopper(s)
- Pebbles enter the fuel handling and storage system one by one
- Also consider graphite pebbles for startup core

Major hazards:

- Criticality due to water accidents, graphite pebble misloading, tank rupture
- Development of graphite dust leading to fire hazard

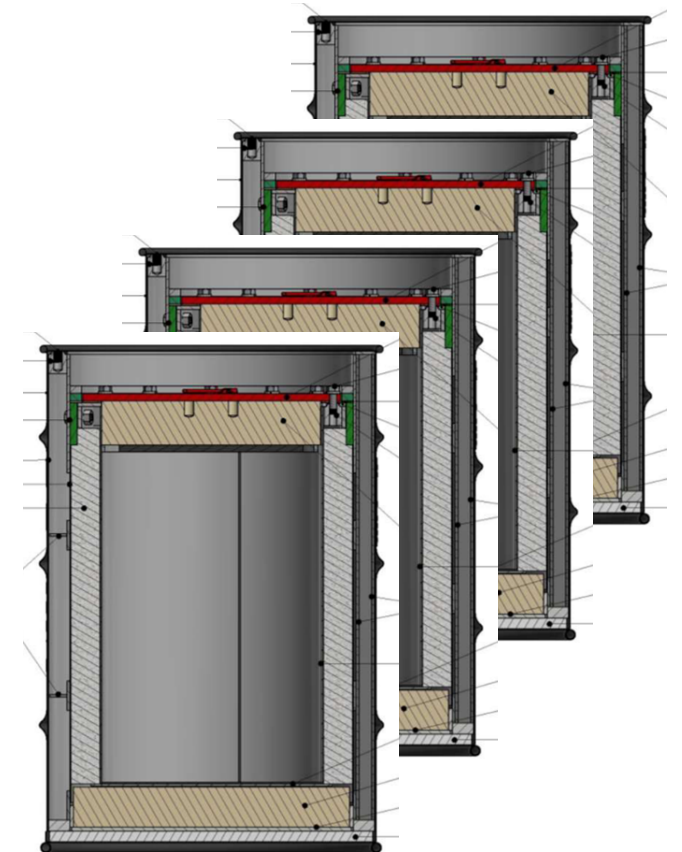

U2: Power Production Including Online Refueling

Fuel Handling and Storage System:

- Loading and unloading of pebbles into and from the reactor core while the reactor is operating at power
- Integrity verification: Separate out broken/damaged spheres
- Measurement of each fuel pebble's burnup via gamma spectroscopy
- Lift the sphere to the top of the reactor through pneumatic pressure tubes and other means

Major hazards:

- Criticality due to pebble misloading, incorrect burnup measurement, failed core unloading device
- Temperature increase in pipes or core due to stuck pebbles
- Fission product release into coolant or adsorption into graphite dust
- Graphite oxidation due to chemical attack

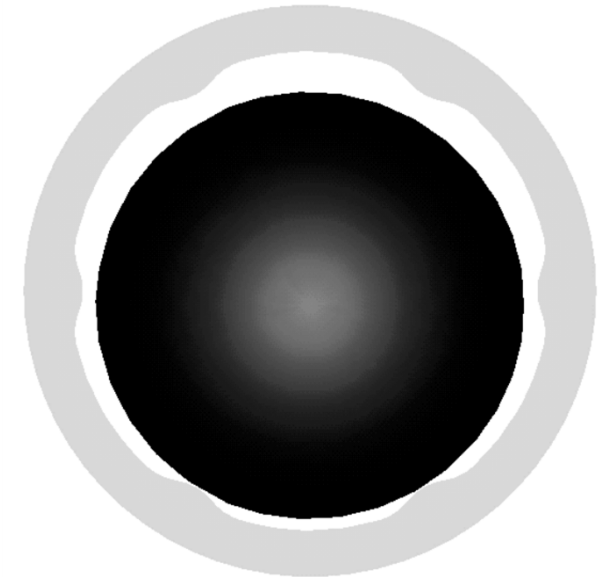

- Pipe OD: 82mm
- Pipe ID: 67 - 63.5mm

Ref.: C. C. Stoker et al. PBMR Used Fuel Storage Criticality for Most Reactive Core Loading. Proc. ICNC, St. Petersburg, Russia, 28 May-1 June, pages 8-14, 2007.

U4: Onsite Discharged Pebble Storage

- **10 Spent Fuel Tank (SFT):**
 - 620,000 pebbles per container
 - Interim storage of up to 80 years (40 years of reactor operation + 40 years of additional onsite storage)
- **1 Graphite Storage Tank (GST)**
 - Graphite pebbles from startup core
- **1 Used Fuel Tank (UFT):**
 - unloading of pebbles from core for maintenance, reflector replacement etc.

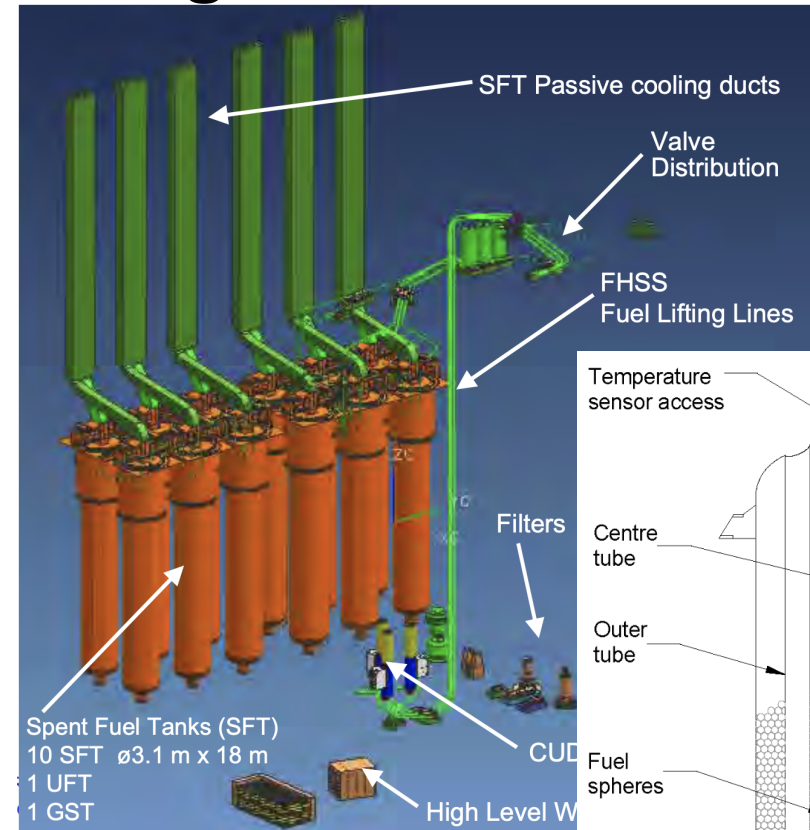

Ref.: J. Slabber. *Reactor Unit and Main Support Systems.*
<https://www.nrc.gov/docs/ML0606/ML060680079.pdf>, 2006

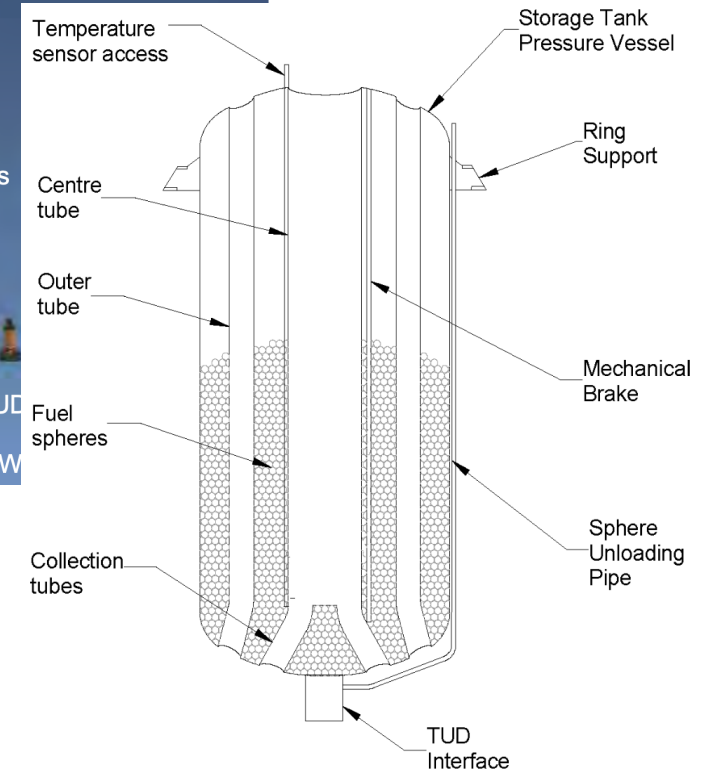

Ref.: C. C. Stoker et al. *PBMR Used Fuel Storage Criticality for Most Reactive Core Loading.* Proc. ICNC, St. Petersburg, Russia, 28 May–1 June, pages 8–14, 2007.

Major hazards:

- Criticality due to water accidents, graphite pebble misloading, tank rupture
- Insufficient heat removal due to failed cooling
- Release of fission products from damaged pebbles
- Development of graphite dust leading to fire hazard

Summary

Major differences in the HTGR fuel cycle compared to LWR:

- Use of High Assay Low Enriched Uranium (HALEU) fuel with up to 19.75 wt% ^{235}U
- No approved *commercial* size transportation and storage packages for UF_6 and fresh fuel pebbles
- New chemicals and processes for TRISO particle and fuel pebble fabrication
- Continuous circulation of fuel pebbles with removal of depleted pebbles during operation
- Handling of irradiated fuel pebbles during operation

Major identified hazards:

- Higher enrichment impacting criticality during UF_6 and fuel pebble storage and transportation
- Hazards from the use of the various chemicals (spills, reaction with water, fire, explosion)
- Graphite corrosion leading to fuel pebble damage, and graphite dust leading to fire hazard
- Fission product release from damaged fuel pebbles

Additional details needed:

- Onsite fresh fuel pebble and graphite pebbles storage details
- Fuel pebble handling and (un)loading procedure (pressure boundaries, canisters, loading devices, etc.)
- Onsite spent fuel pebble storage design details
- HTGR containment and building design details

Nuclide inventory, decay heat, and criticality calculations with SCALE for the HTGR fuel cycle

R. ELZOHERY, D. HARTANTO,
F. BOSTELMANN, W. WIESELQUIST

NRC PUBLIC WORKSHOP

FEBRUARY 28, 2023



U.S. NRC

 **OAK RIDGE**
National Laboratory



Sandia
National
Laboratories

Objective and applications

- **Objective:**
 - Demonstrate SCALE capabilities for simulating different stages of the HTGR fuel cycle
- **Selected scenarios for demonstration**
 - UF₆ transportation
 - **Scenario 1:** Water ingress into array of canisters at optimal moderator to fuel ratio
 - **Analysis:** Perform SCALE criticality calculations*
 - Fresh fuel pebble transportation
 - **Scenario 2:** Damage/drop of a container leading to reduced array spacing and potential criticality
 - **Analysis:** Perform SCALE criticality calculations*
 - Fuel utilization
 - **Scenario 3:** FHSS pipe rupture: pebbles exit out of the reactor with high temperature and pressure, leading to graphite and air interaction
 - **Analysis:** Determine equilibrium core, simulate individual pebbles; MELCOR selects target pebbles for severe accident progression
 - Onsite storage of spent fuel
 - **Scenario 4:** Collision of vehicle or suspended load with storage tank causing damage to tank and damage to pebbles inside tank, causing fission product and graphite dust release
 - **Analysis:** Use individual pebbles to build up inventory in a storage tank; MELCOR uses tank decay heat/inventory for severe accident progression

* This is not full certification type analysis, but an analysis for demonstration of capabilities

Reference HTGR: PBMR-400

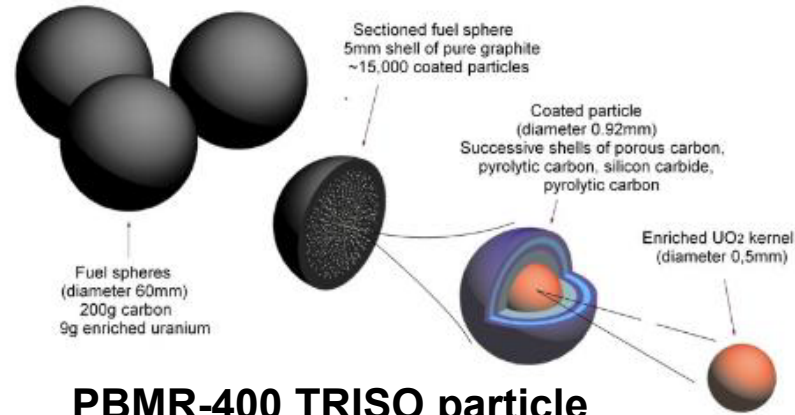

PBMR-400 TRISO particle and fuel pebble [1]

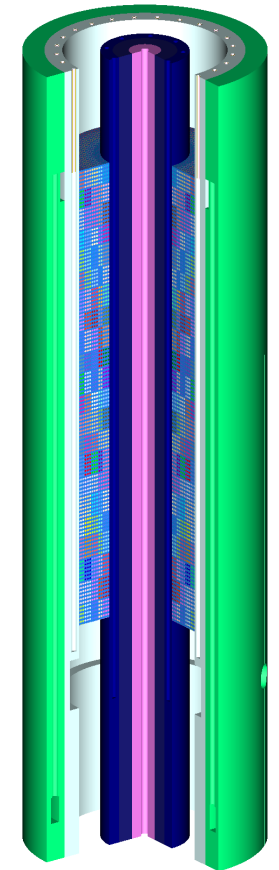
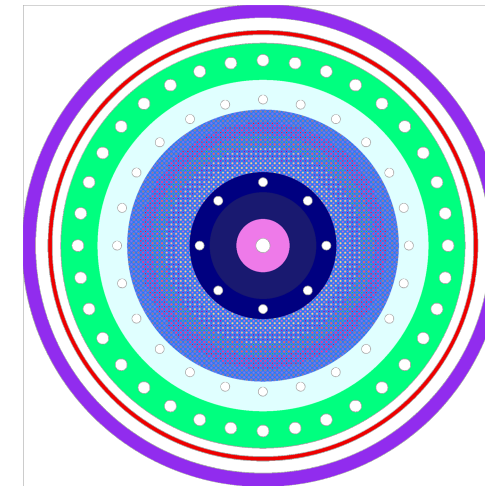

PBMR-400 SCALE model [2]

Characteristic	Value
Thermal power	400 MWth
Fuel enrichment	9.6 wt.% ²³⁵ U
Target discharge burnup	90 GWd/MTU
Number of pebbles in core	~452,000

[1] Nuclear Science Committee, Nuclear Energy Agency (NEA), "PBMR Coupled Neutronics / Thermal-hydraulics Transient Benchmark The PBMR-400 Core Design, vol. 1: The Benchmark Definition," NEA/NSC/DOC(2013)10, Paris, France, 2013.

[2] S. E. Skutnik and W. A. Wieselquist, "Assessment of ORIGEN Reactor Library Development for Pebble-Bed Reactors Based on the PBMR-400 Benchmark", [ORNLTM-2020/1886](https://www.ornl.gov/sites/default/files/2020-11/ORNLTM-2020-1886.pdf), Oak Ridge National Laboratory, Oak Ridge, TN (July 2021)

Scenario 1: Water ingress into packages during UF₆ transportation



U.S. NRC



**Sandia
National
Laboratories**

DN30-X UF₆ transportation package

- **DN30-X is a new transportation package with neutron poisons designed for HALEU**
- **X** is a specific design identifier. Either **10** for a maximum enrichment of 10 wt% or **20** for a maximum enrichment of 20 wt%
- The package contains:
 - **Protective Structural Packaging (PSP)**
 - 30B-X cylinder (30B-10 or 30B-20)
- Both 30B-10 and 30B-20 have identical outer dimensions to the standard 30B cylinder
- The 30B-X cylinder contain Criticality Control Rods (CCRs) made of boron-carbide
- The PBMR fuel enrichment, **9.6 wt% ²³⁵U**, is used for calculations with the 30B-10 model
- The maximum HALEU enrichment, **20 wt%**, is used for calculations with the 30B-20 model

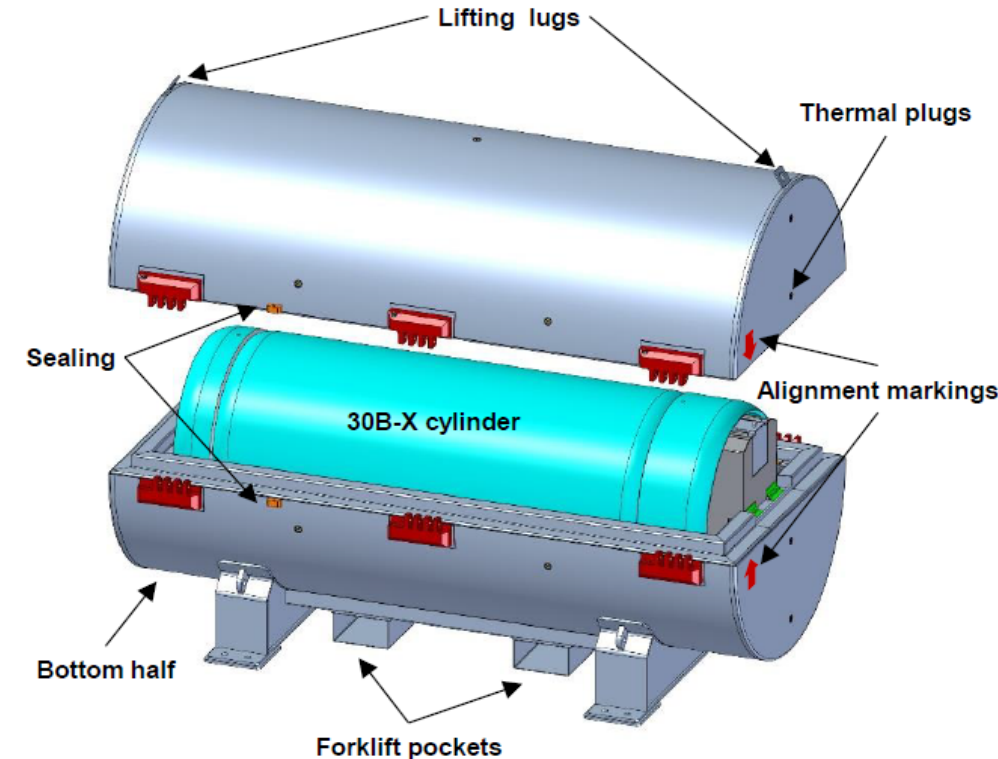

DN30-X package*

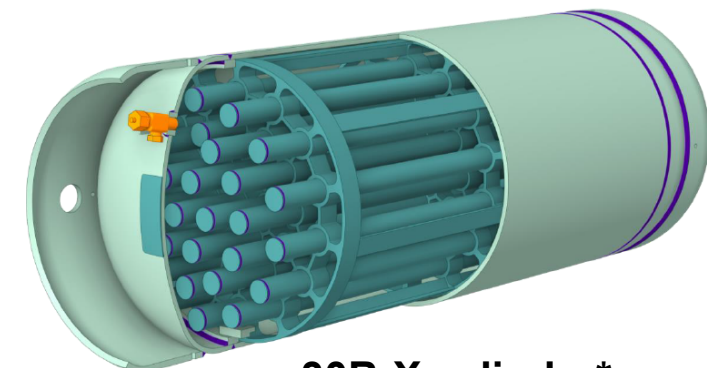

30B-X cylinder*

* Safety Analysis Report for the DN30-X Package

<https://adamswebsearch2.nrc.gov/webSearch2/main.jsp?AccessionNumber=ML22327A183>

SCALE model of DN30-X package

Model tools and data:

- Neutron transport code: SCALE's Monte Carlo code Shift
 - Shift is optimized for performance in parallel → fast results with multiple cores
 - k_{eff} calculations converged to 10 pcm statistical uncertainty
- Nuclear data versions: ENDF/B-VII.1 and ENDF/B-VIII.0 continuous energy libraries

Conservative modeling assumptions:*

- Lattice holder, valve, plug, and nameplate are neglected
- The foam material in the PSP is neglected
- UF_6 is assumed at a theoretical density of 5.5 g/cm^3 with 0.5 wt % HF impurities
- Cylinders are 100% filled with UF_6 (exceeds the permissible mass for the 30B-10 and 30B-20 cylinder; this is conservative from criticality safety perspective)

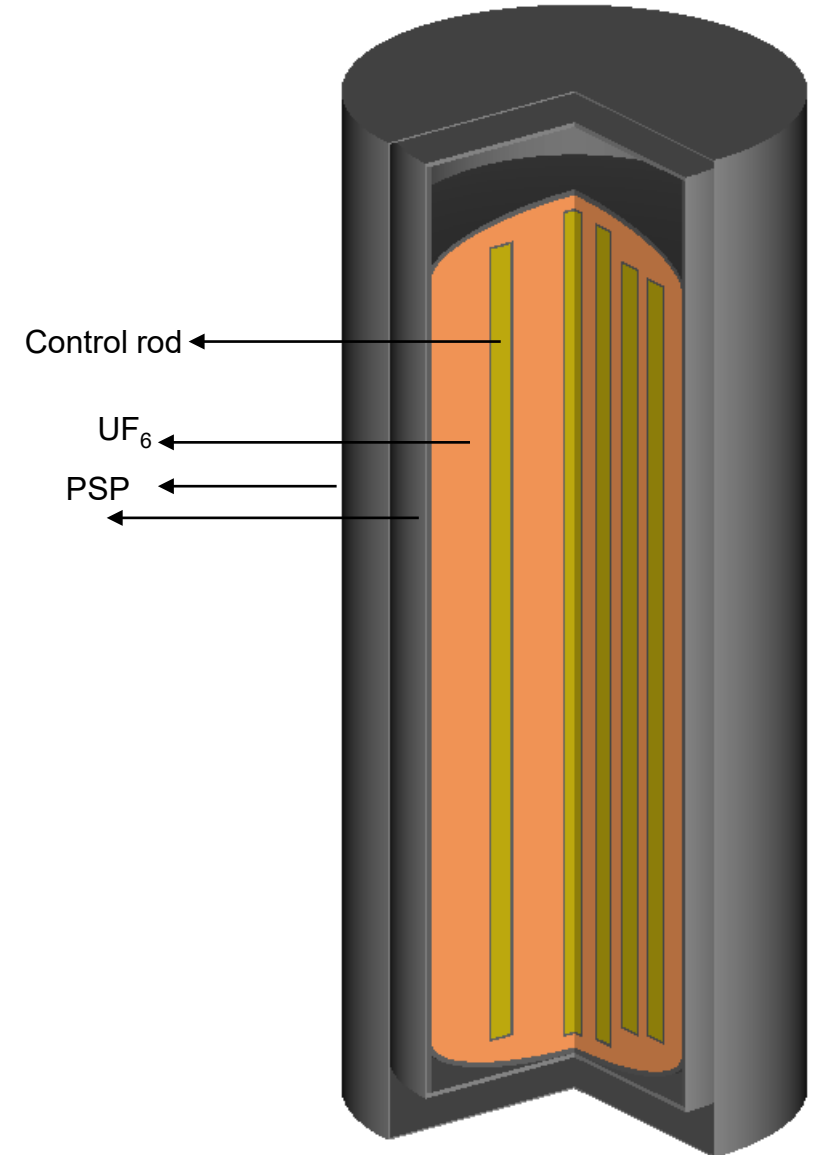

3D view of SCALE model

*The same assumptions in the safety analysis report are adopted: **Safety Analysis Report for the DN30-X Package**, <https://adamswebsearch2.nrc.gov/webSearch2/main.jsp?AccessionNumber=ML22327A183>

SCALE baseline result for DN30-X

Nuclear Data Library	DN30-10	DN30-20
k_{eff} ENDF/B-VII.1 CE	0.58459 +/- 0.00011	0.77772 +/- 0.00011
k_{eff} ENDF/B-VIII.0 CE	0.58549 +/- 0.00010	0.77761 +/- 0.00011
Δk (pcm)	90 +/- 15	-11 +/- 16

Infinite hexagonal array of packages touching on sides, surrounded by air—no water ingress.

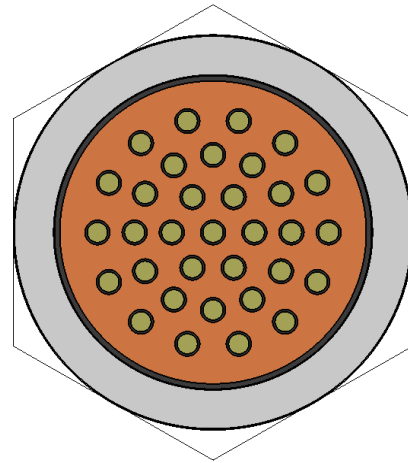

30B-10
(33 control rods)

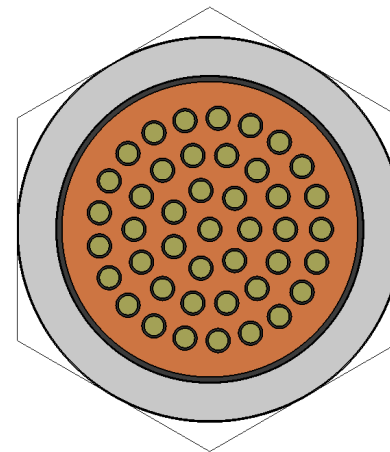

30B-20
(43 control rods)

Control rod ←

UF₆ ←

PSP ←

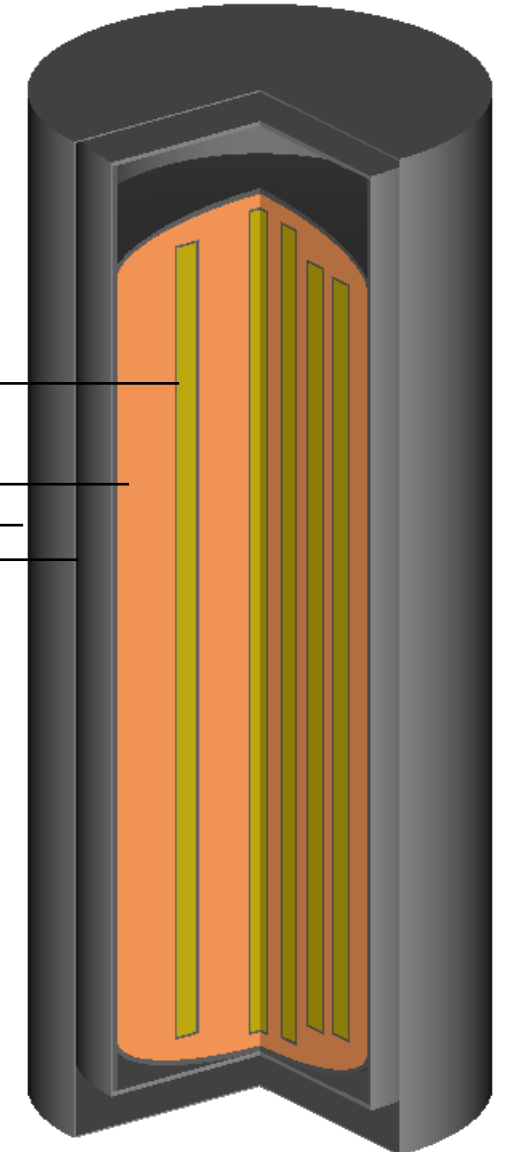

3D view of SCALE model*

*The same assumptions in the safety analysis report are adopted: **Safety Analysis Report for the DN30-X Package**, <https://adamswebsearch2.nrc.gov/webSearch2/main.jsp?AccessionNumber=ML22327A183>

Impact of water on criticality for DN30-10

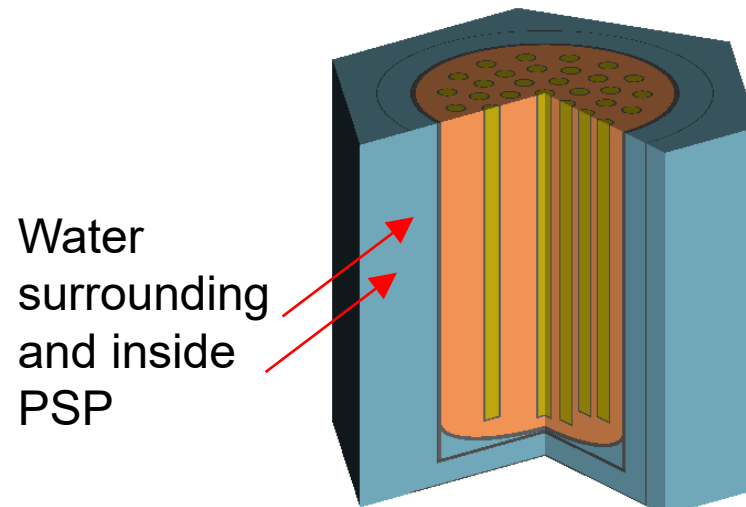
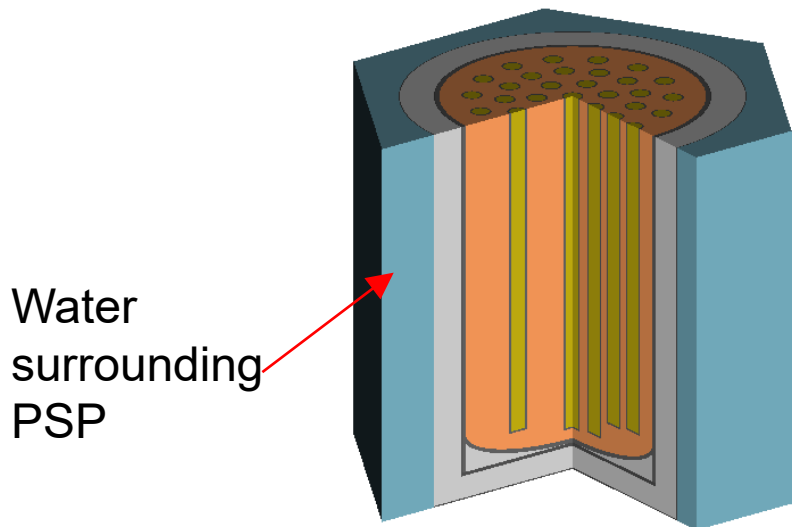
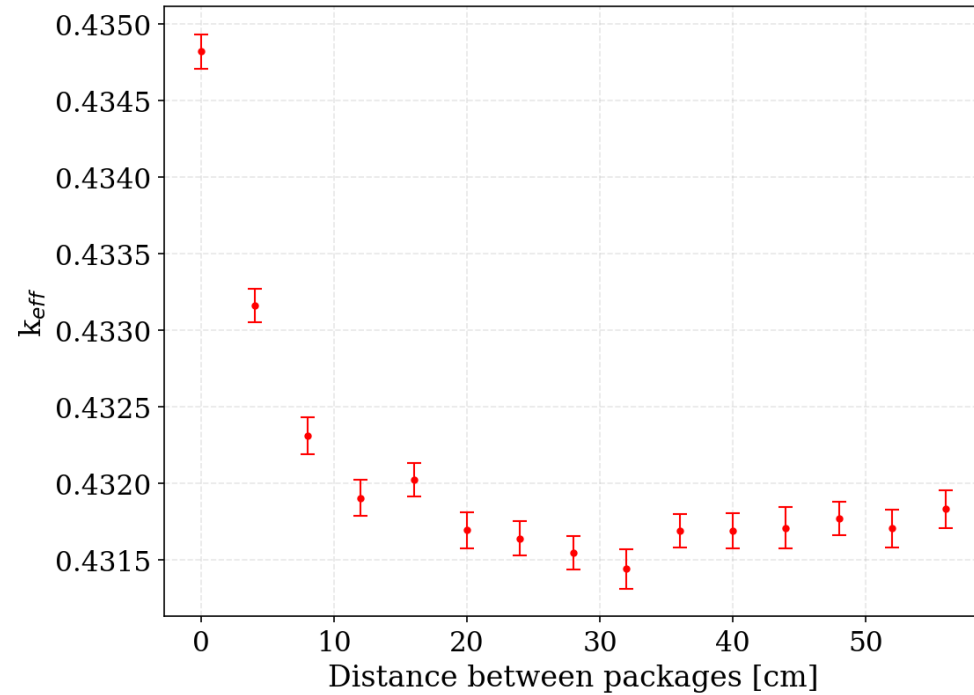
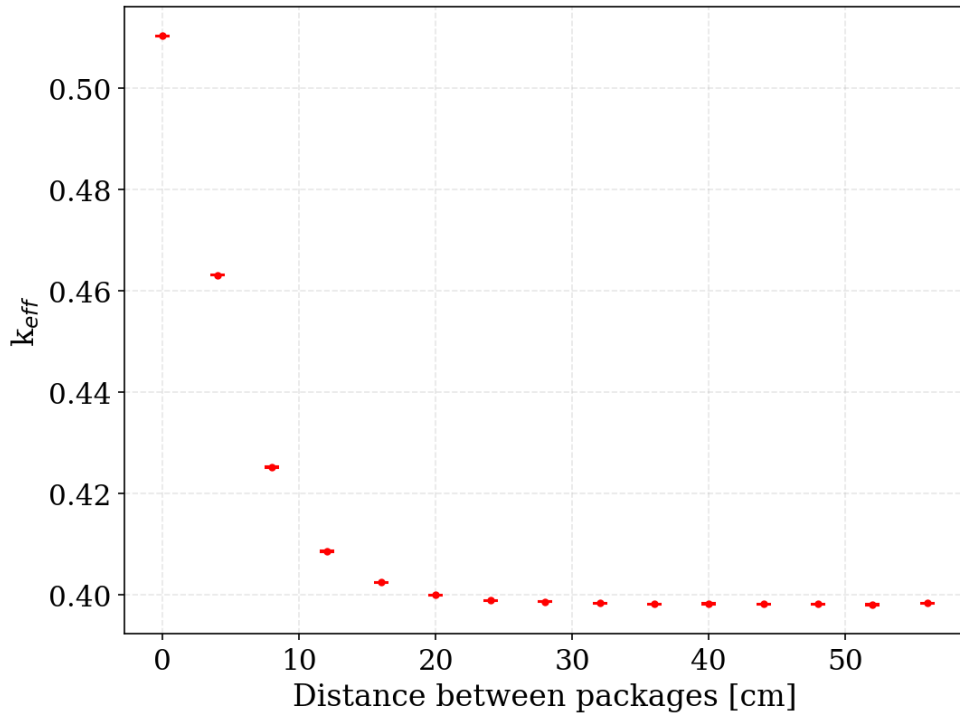

- Minimum package pitch (touching) is the most reactive configuration.
- Water ingress into PSP has lower k_{eff} .

Impact of water on criticality for DN30-20

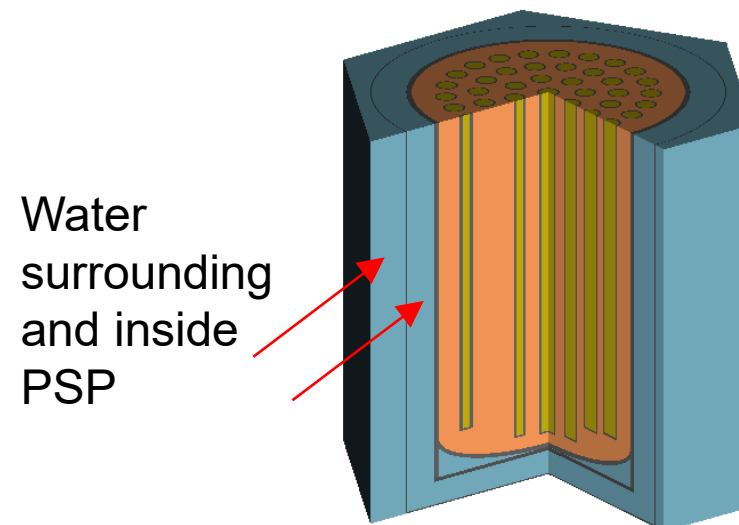
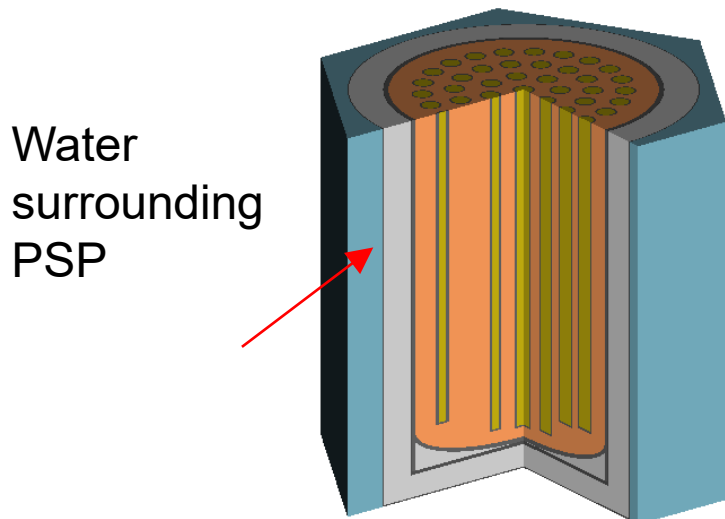
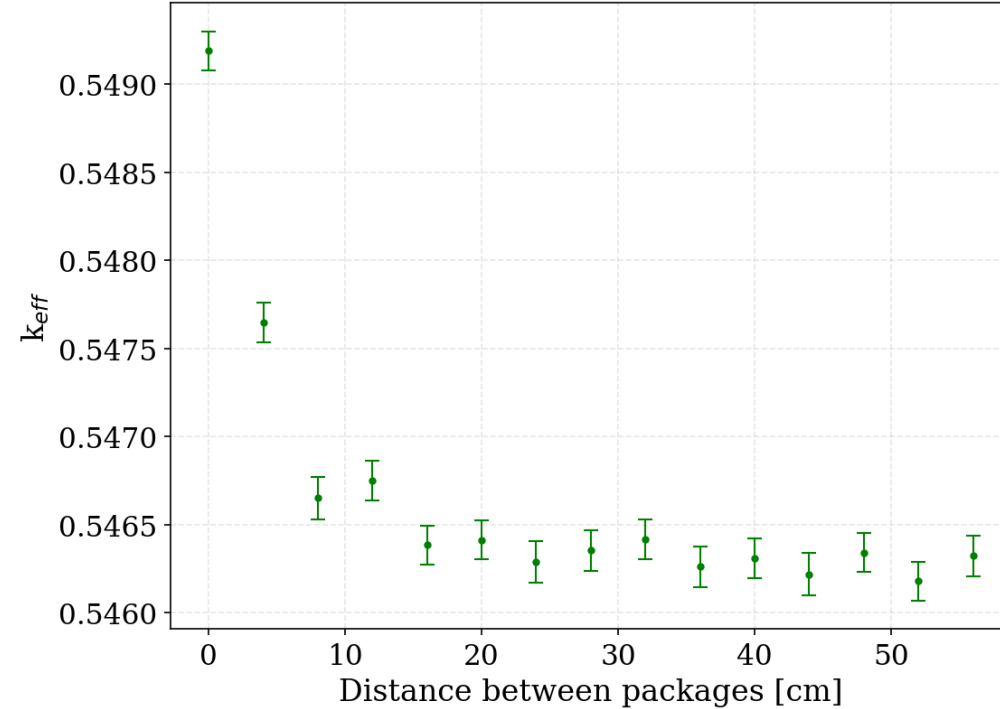
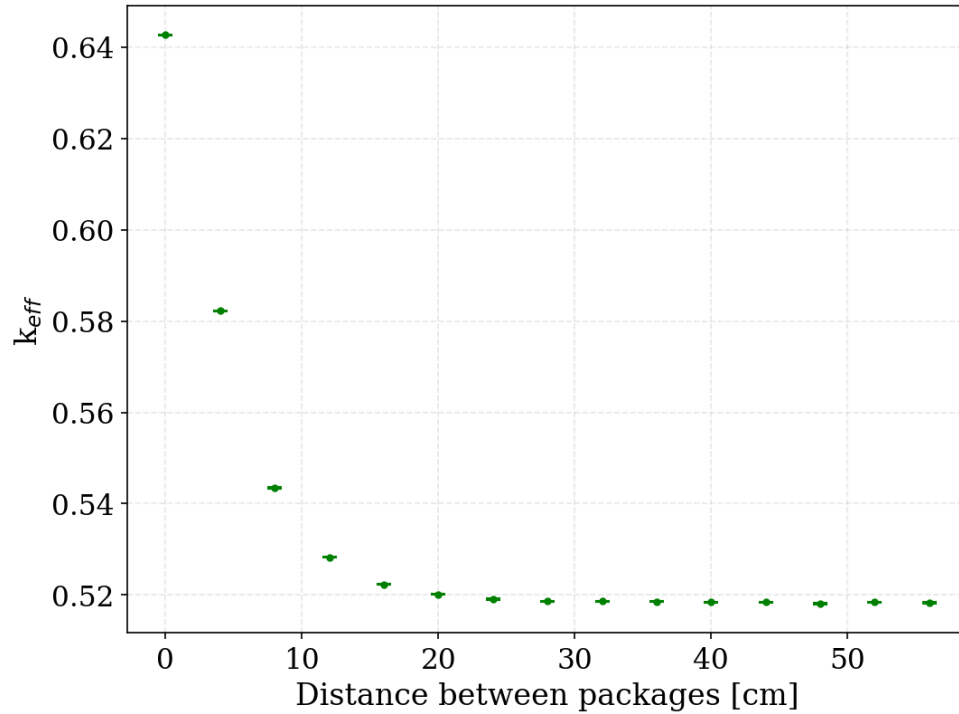

DN30-20 shows the same trends as DN30-10.

Additional moderation from surrounding water or ingress into PSP, decreases k_{eff} from baseline.

Scenario 2: Damage/drop during fresh fuel pebble transportation



U.S. NRC



**Sandia
National
Laboratories**

Fresh pebble transportation package

- **Versa-Pac Package:**

- 55-gallon package (VP-55)
- The payload containment area is contained in a drum for enhanced structural protection.
- The package's interior is completely insulated with the appropriate layers of ceramic fiber.
- Mass loading of ^{235}U is determined by enrichment.

- **Fuel pebbles:**

- PBMR-400 fuel pebbles

Characteristic	Value
Fuel enrichment	9.6 wt.% ^{235}U
TRISO packing fraction	~9%
Uranium content per pebble	9 g

- Container permits maximum of 584 pebbles based on given enrichment, and up to 505 g of ^{235}U permitted loading. 364 pebbles fit into container at 55% packing fraction.

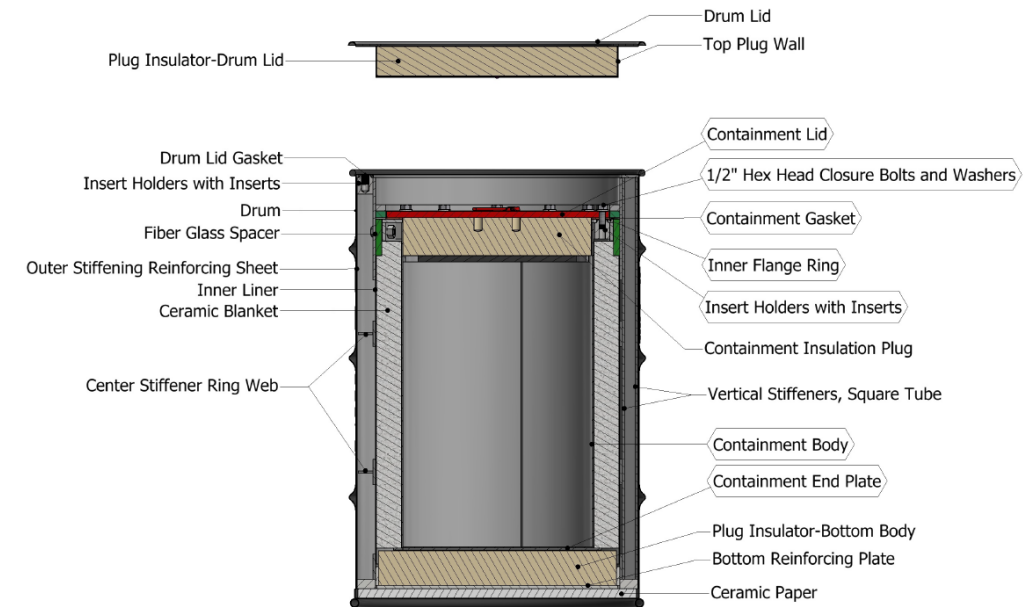

Versa-Pac Illustration*

* Versa-Pac Safety Analysis Report, <https://www.nrc.gov/docs/ML1833/ML18330A093.pdf>

SCALE model of the VP-55

Model tools and data:

- Neutron transport code: SCALE's Monte Carlo code Shift
 - Shift is optimized for performance in parallel → fast results with multiple cores
 - keff calculations converged to 10 pcm statistical uncertainty
- Nuclear data versions: ENDF/B-VII.1 and ENDF/B-VIII.0 continuous energy and multi-group libraries
- Continuous-energy model: TRISO particles are explicitly modeled and randomly distributed inside the fuel sphere
- Multi-group model: TRISO particles in fuel sphere modeled via double-heterogeneous unit cell for resonance treatment

Model details:

- 364 pebbles are placed inside the container, equivalent to 315 grams of ^{235}U , and 55% packing fraction (assumption)
- Reflective boundary conditions account for an array of containers
- Insulation specifications are not well-defined, since they depend on the manufactures and fabrication, but the used material densities are within the recommended limits



3D SCALE VP-55 model

SCALE baseline result for the VP-55

Reference: Infinite array of touching containers surrounded by air

library	$k_{\text{eff}} \pm \text{sigma}$	$\Delta k_{\text{MG-CE}}$ (pcm)	Δk_{ENDF} (pcm)
ENDF/B-VII.1 CE	0.30387 +/- 0.00010	(ref)	(ref)
ENDF/B-VII.1 252g	0.30416 +/- 0.00010	29 +/- 14	
ENDF/B-VIII.0 CE	0.30575 +/- 0.00010	(ref)	188 +/- 14
ENDF/B-VIII.0 252g	0.30486 +/- 0.00010	90 +/- 14	

- **Runtime comparison:**

- SCALE 6.3: CE runtime $\approx 20x$ MG runtime
- SCALE 7.0 development: CE runtime $\approx 2x$ MG runtime

- **Impact of fuel pebble random distribution:**

- Mean of bias and bias uncertainty due to random pebbles distribution is studied by running 10 different random realizations with ENDF/B-VII.1 252g
- Average k_{eff} : 0.30406 +/- 0.00003
- Difference to reference result: $\Delta k_{\text{eff}} = 10 \pm 10$ (pcm)
 → The impact of the explicit pebble distribution in this model is negligible

Impact of damage/drop on criticality for VP-55

PF = 0.55 (364 pebbles)

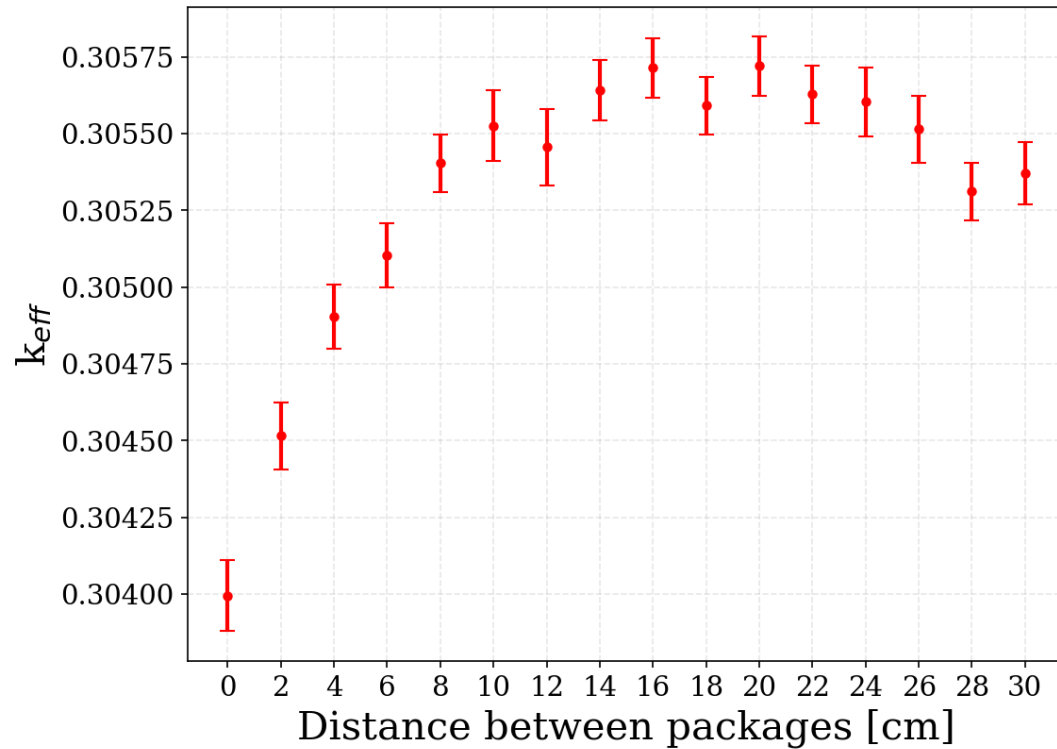

Potential increase in pebble packing fraction and package array spacing



PF = 0.60 (397 pebbles)

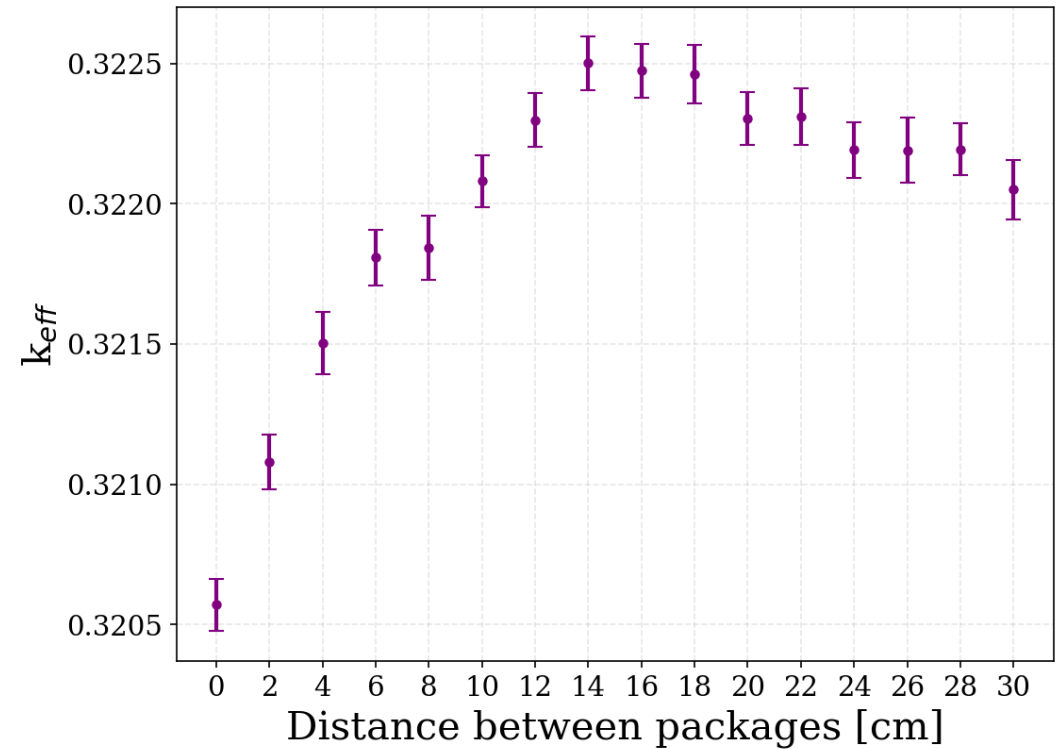

- Both packing fraction and package array spacing increase k_{eff} from baseline to a slight optimum at 14-16 cm spacing.
- Max potential increase ~300pcm for the PF=0.6 case.
- Array of packages still very low with max k_{eff} ~0.33.

Additional water/flooding scenarios for VP-55

a) Impact of water surrounding the containers

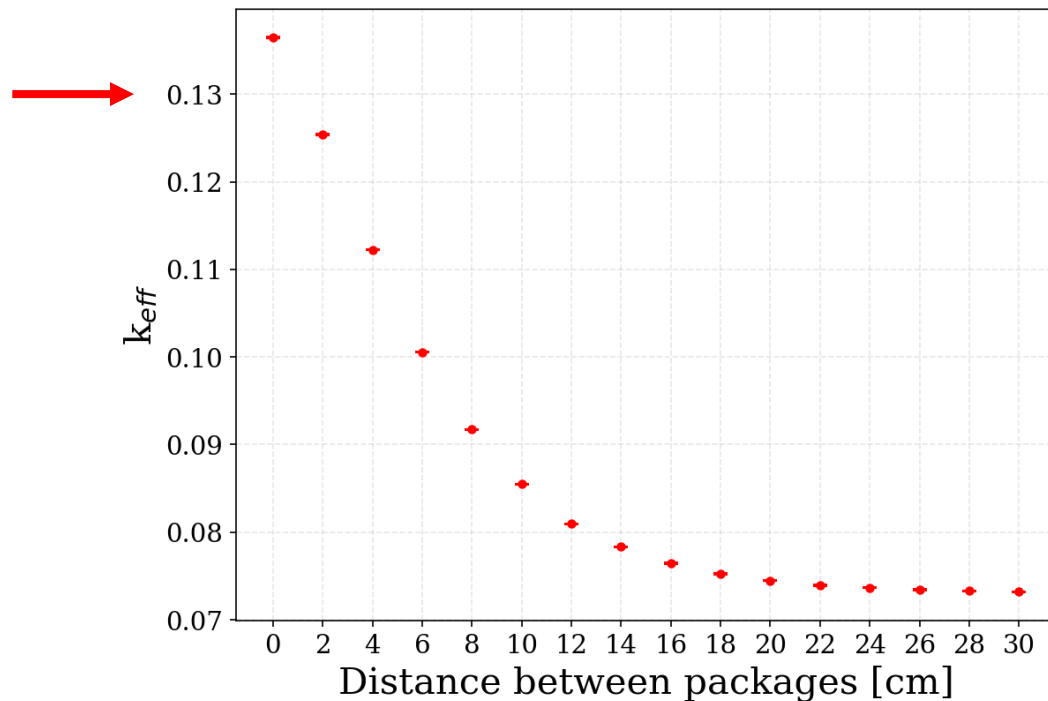

b) Impact of water surrounding containers and water ingress into the container

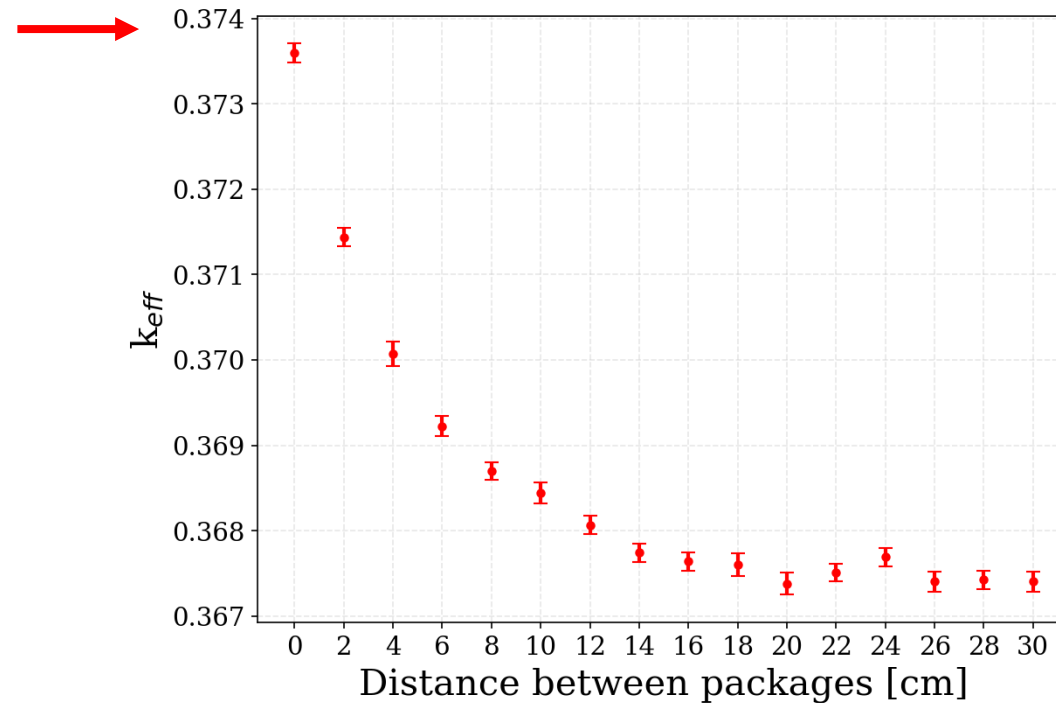

For all cases, largest k_{eff} found when cylinders are touching (unlike the air-only case)

Scenario 3: Pebble ejection from fuel handling system



U.S. NRC



**Sandia
National
Laboratories**

SCALE approach for fuel inventory generation

- **Zone-wise equilibrium core inventory:**
 - The SCALE PBMR-400 core model¹ was divided into 5 radial channels and 22 axial regions
 - Zone-average inventory corresponding to an equilibrium state was generated with an established approach²
 - Core-average inventory is equal to the inventory of a used fuel tank (UFT) which contains all pebbles during maintenance
 - An inventory interface file with core-average inventory was provided to MELCOR

- **Rapid inventory of 20,000 individual pebbles:**
 - Inventory was generated based on random pebbles histories, considering different radial channels and associated power distributions³
 - Seven passes were simulated for each pebble
 - An inventory interface file containing the 20,000 pebble inventories was provided to MELCOR

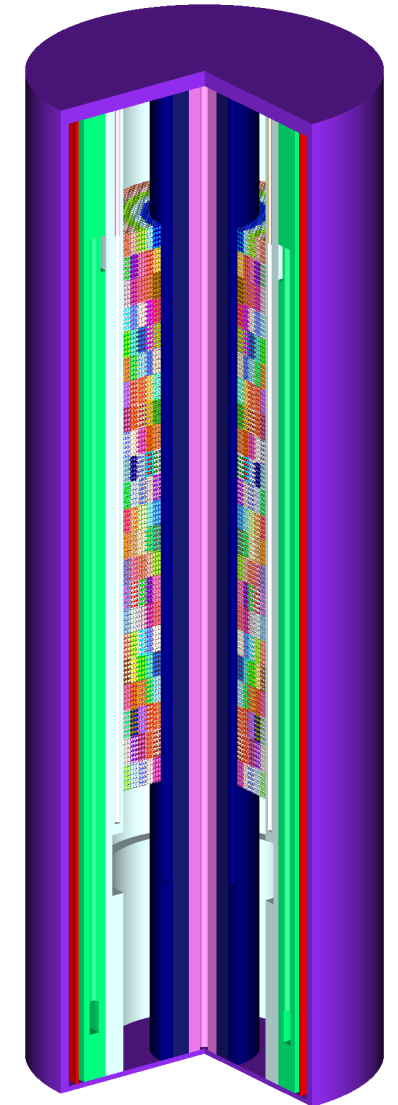

SCALE PBMR-400 model

[1] S. E. Skutnik et al. (2021), [ORNL/TM-2020/1886](#), Oak Ridge National Laboratory, Oak Ridge, TN

[2] F. Bostelmann, et al. (2021), [ORNL/TM-2021/2273](#), Oak Ridge National Laboratory, Oak Ridge, TN

[3] D. Hartanto, et al. (2022), "[Uncertainty Quantification of Pebble's Discharge Burnup and Isotopic Inventory Using SCALE](#)," Proc. ANS Winter Meeting, Phoenix, AZ, November 13–17.

Characteristics of pebbles in PBMR-400

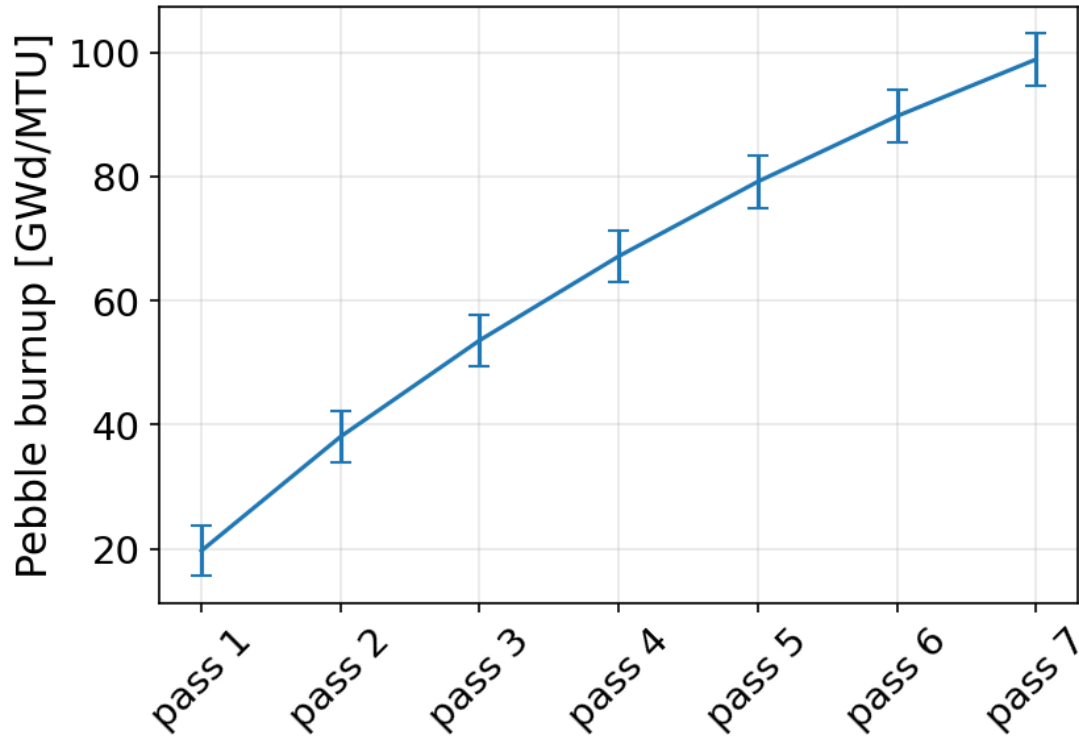

Average pebble burnup after each pass

The error bars correspond to the burnup range after each pass

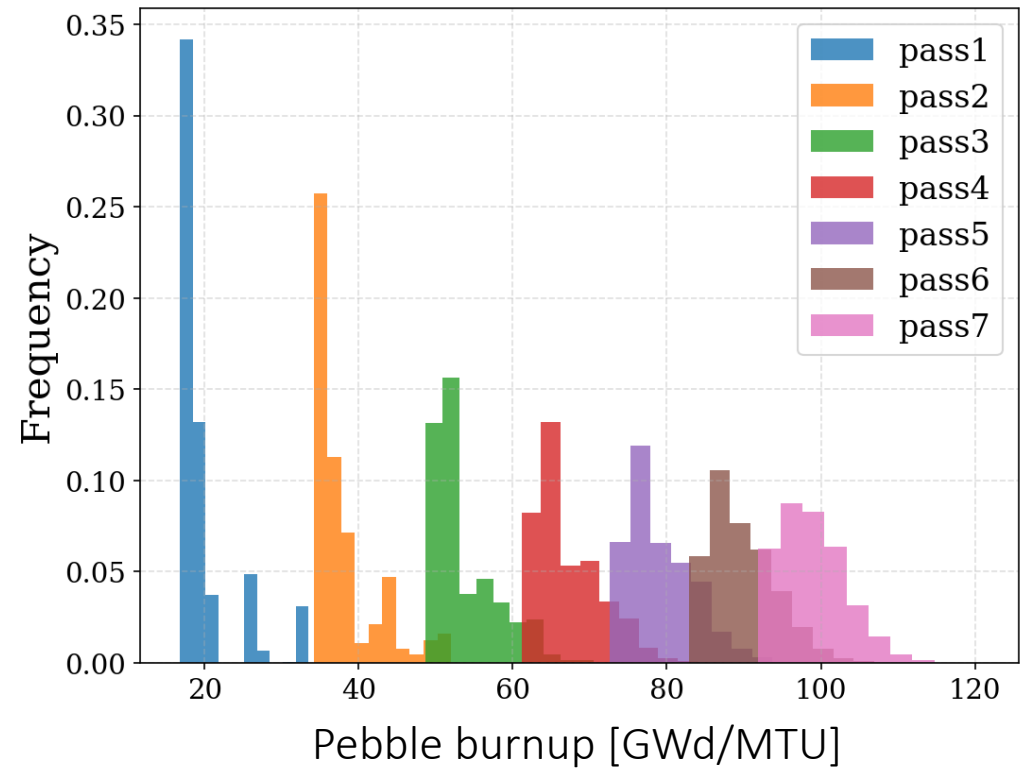

Burnup distribution after each pass

Target burnup is 90 GWd/MTU, but 7 passes are simulated to include pebbles that haven't reached the target burnup at 6th pass.

Target burnup and number of passes

- A pebble is retired earlier than the target burnup in case it has a chance to exceed the target if it is returned to the core.
- A burnup cutoff has to be chosen after which pebbles are removed from the system

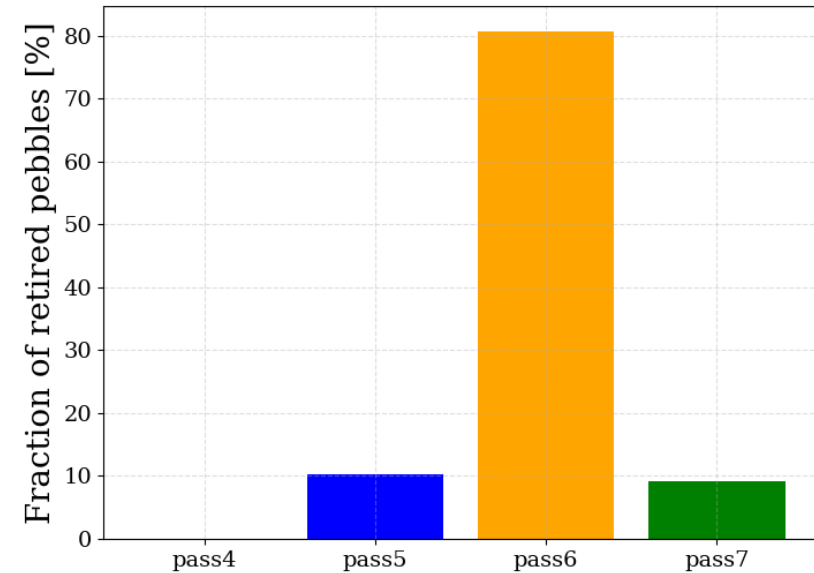
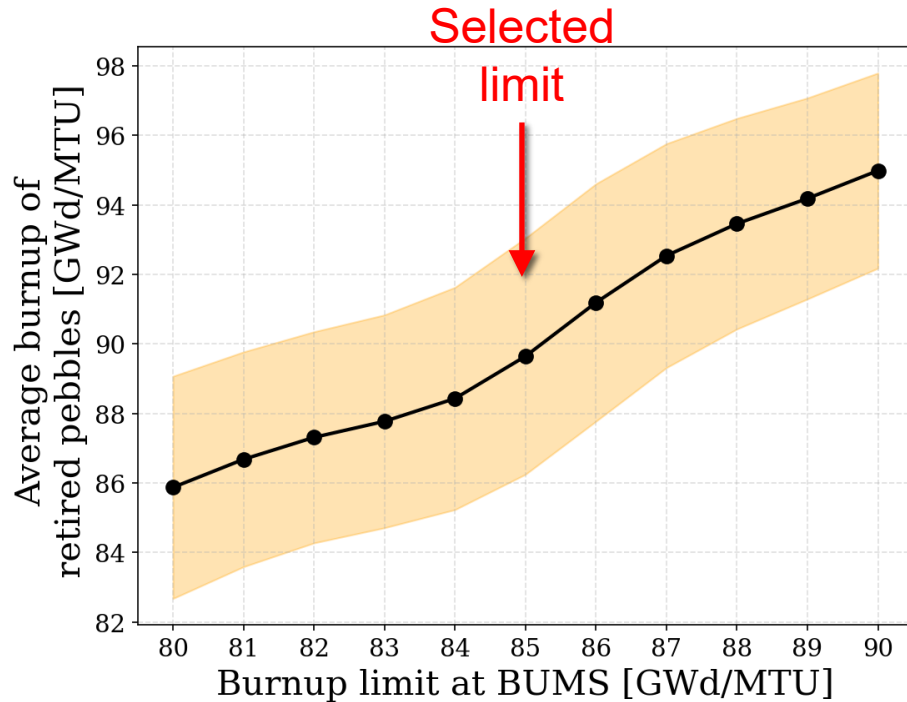

• With burnup limit at BUMS of 85 GWd/MTU, the average burnup of the retired pebbles is ≈ 90 GWd/MTU (target burnup).

• Fraction of retired pebbles using cut-off value 85 GWd/MTU
 • On average, it takes 6 passes through the core for a pebble to reach the target burnup of 90 GWd/tU.

Average decay heat of PBMR pebbles

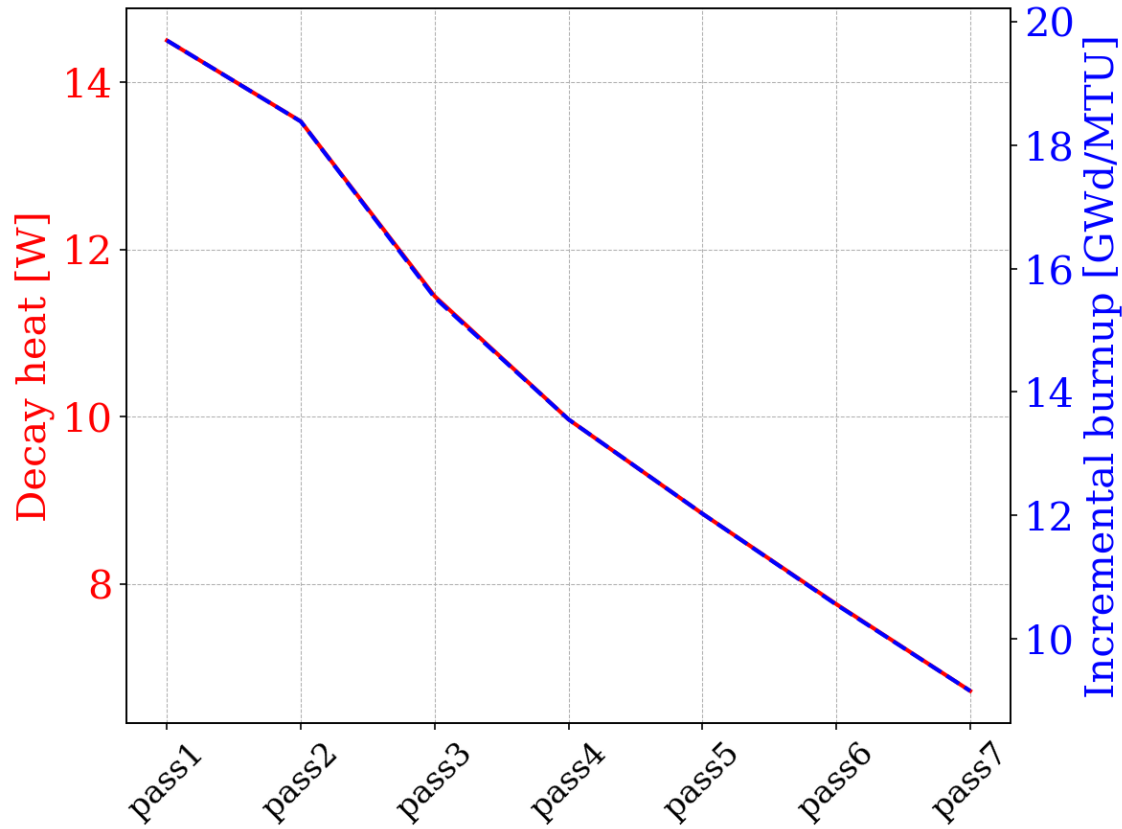

Average decay heat of a pebble at the end of each pass

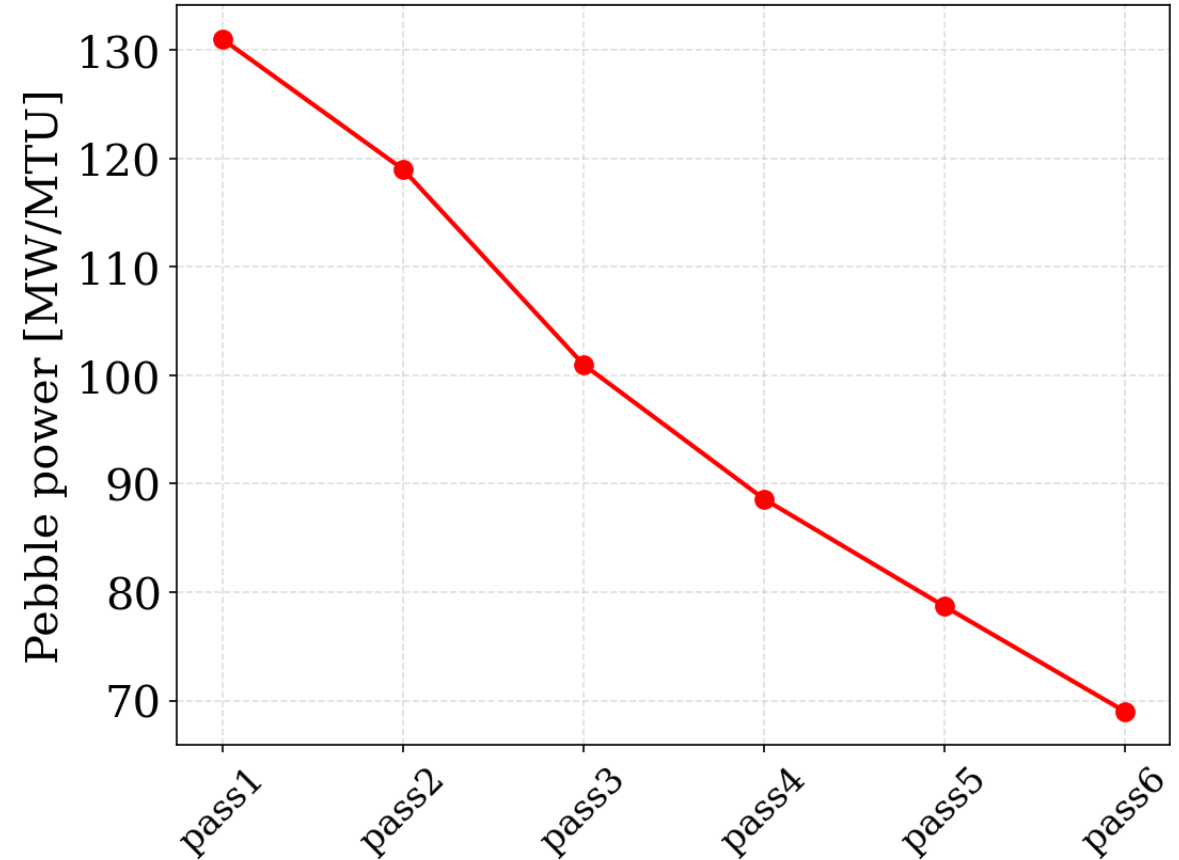

Pebble power decrease with passes leading to a decrease in the decay heat

Top contributors to the decay heat of PBMR pebbles

Pass 1

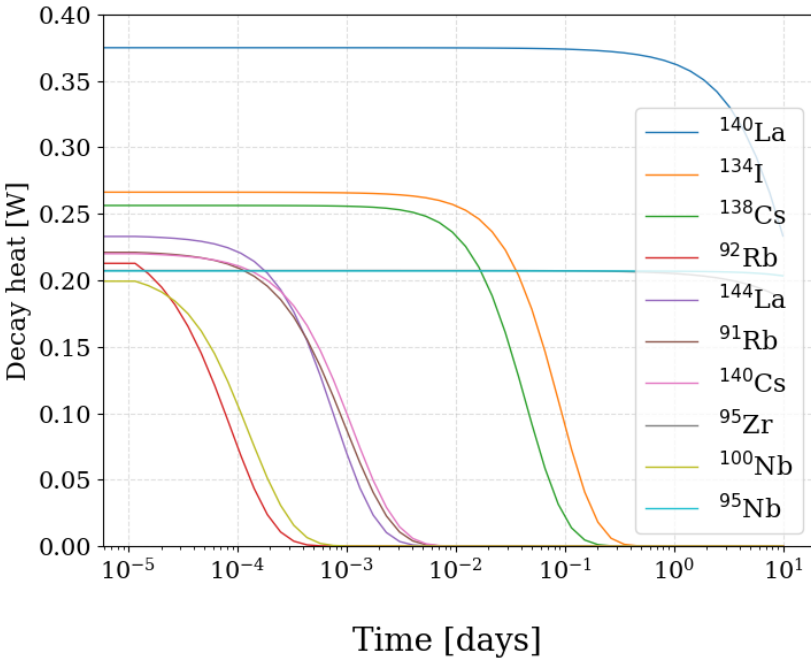

Pass 3

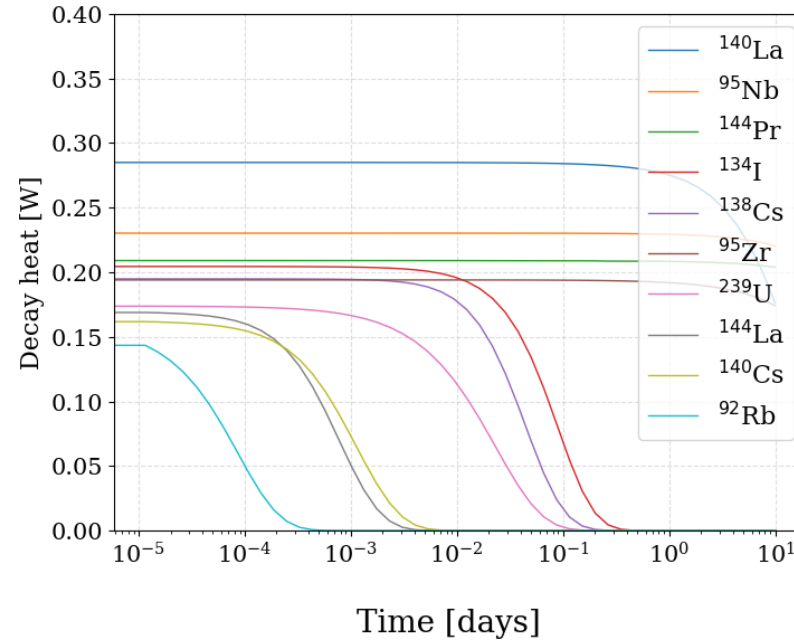

Pass 6

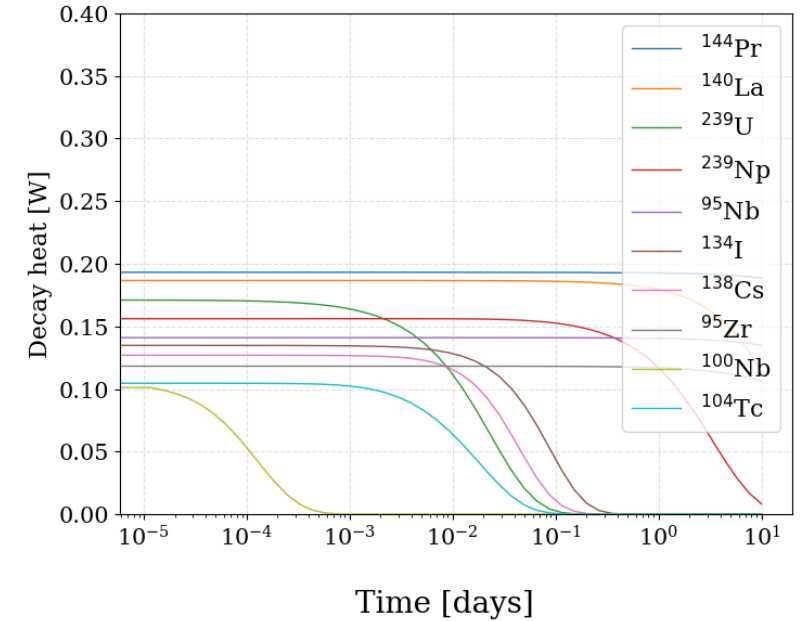

Fission products dominate in early passes because of higher fission rate, then actinides begin to appear among the top 5 contributors in late passes

Scenario 4: Collision with the spent fuel storage tank



U.S. NRC

OAK RIDGE
National Laboratory



**Sandia
National
Laboratories**

PBMR-400 spent fuel tank

- After a pebble is retired, the FHSS moves the pebbles to the spent fuel tank (SFT)
- One SFT can store **620,000** pebbles
- The PBMR-400 has multiple SFTs that together can store all pebbles from entire reactor lifetime
 - Interim storage of up to 80 years (40 years of operation + 40 years of onsite storage)
- **483** fuel pebbles are discharged daily
- It takes **~1,284** days to fill one tank

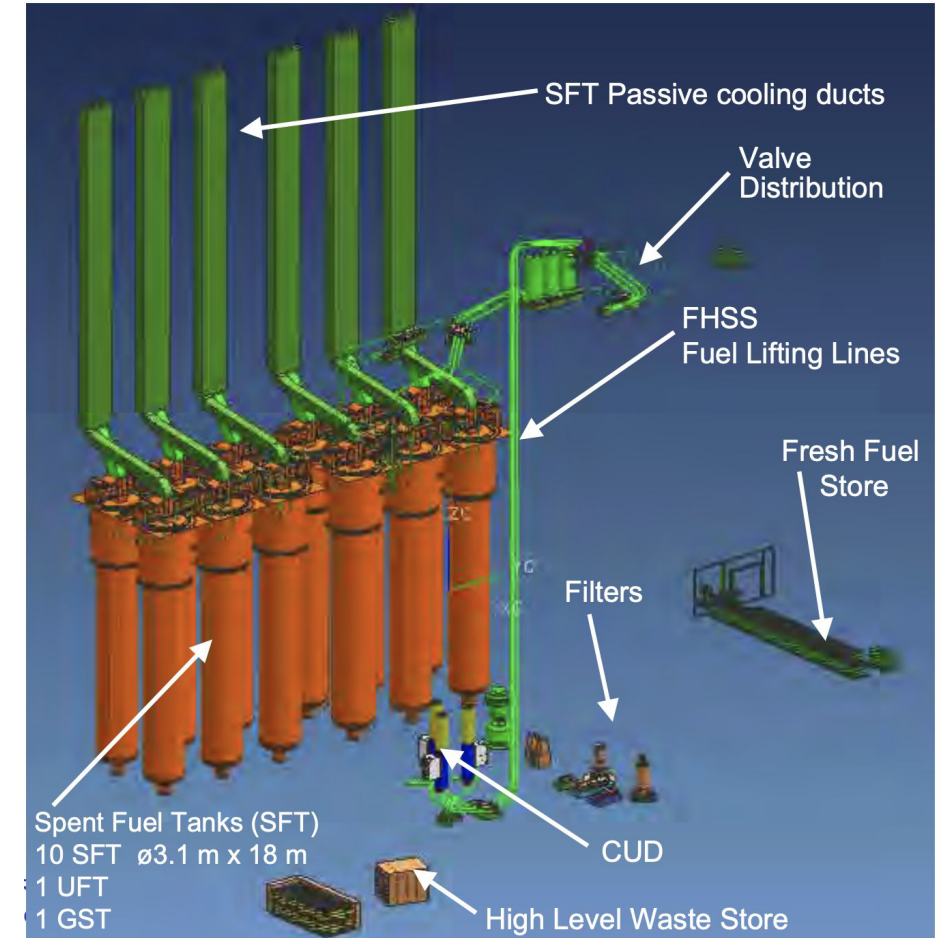

PBMR-400 FHSS with pebble storage tanks*

*J. Slabber. Reactor Unit and Main Support Systems.
<https://www.nrc.gov/docs/ML0606/ML060680079.pdf>, 2006

SFT modeling procedure

- The SFT is filled one day at a time in 1,284 layers
- The discharge inventory of the 20,000 pebbles is blended to compute average discharge inventory.
- Each layer is decayed to the time when the tank is full, as shown on the right.
- An interface inventory file containing inventory of each slice in the spent fuel tank is provided to MELCOR team for accident analysis

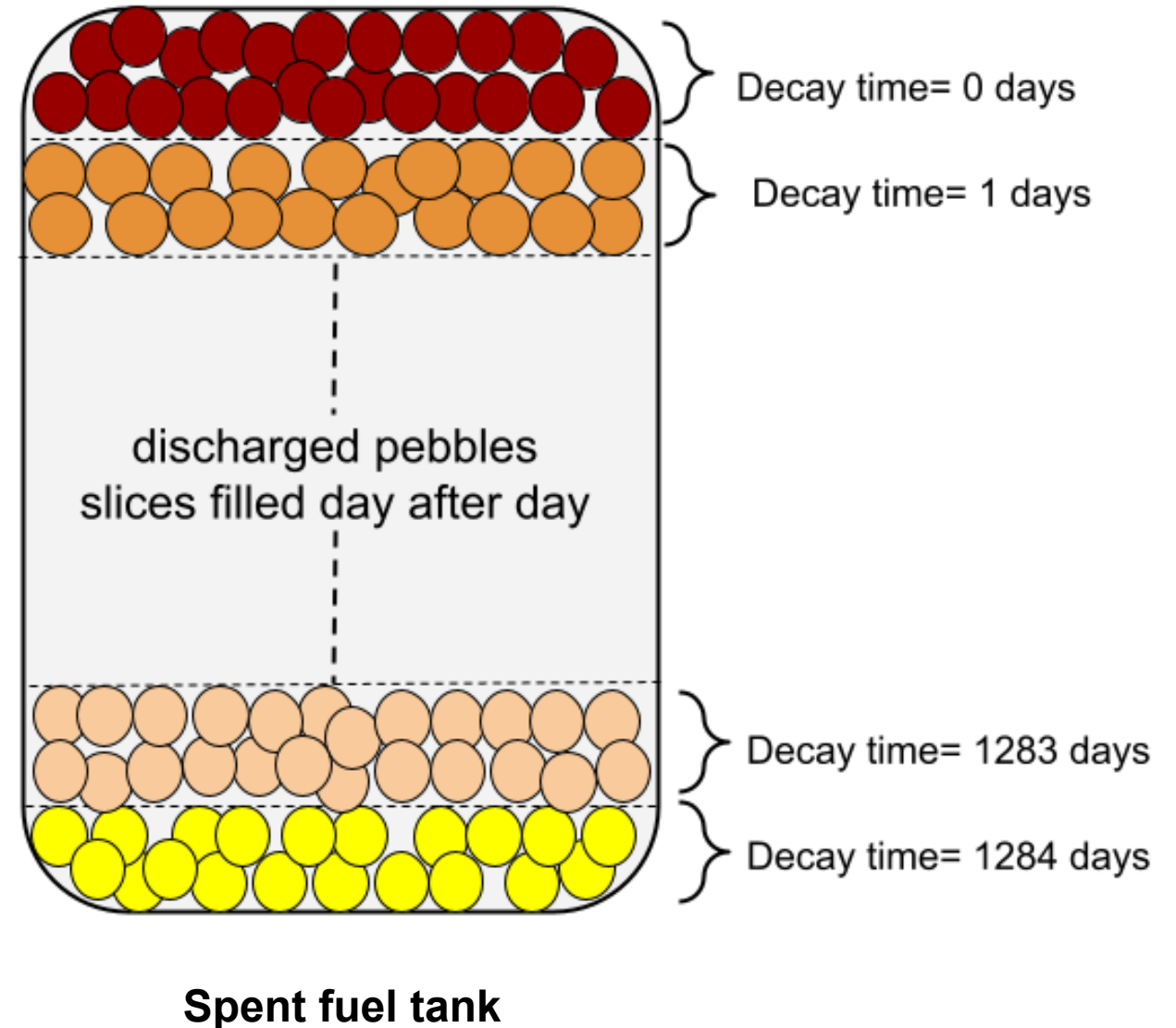

Total decay heat of spent fuel tank (620k pebbles)

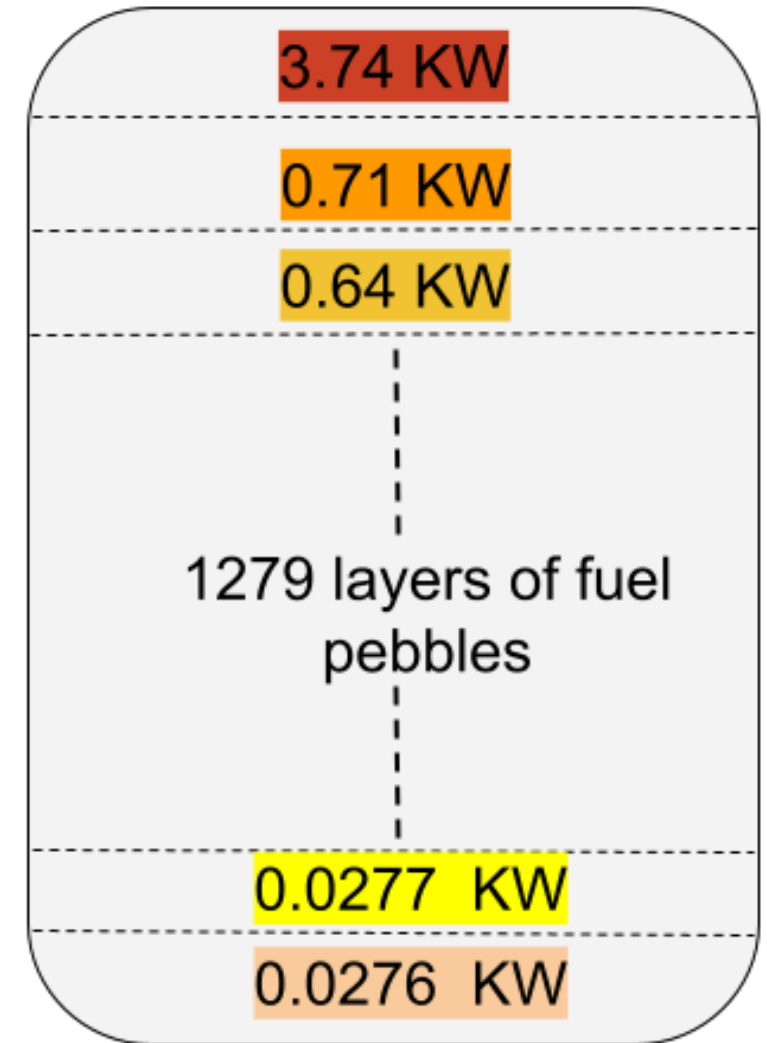
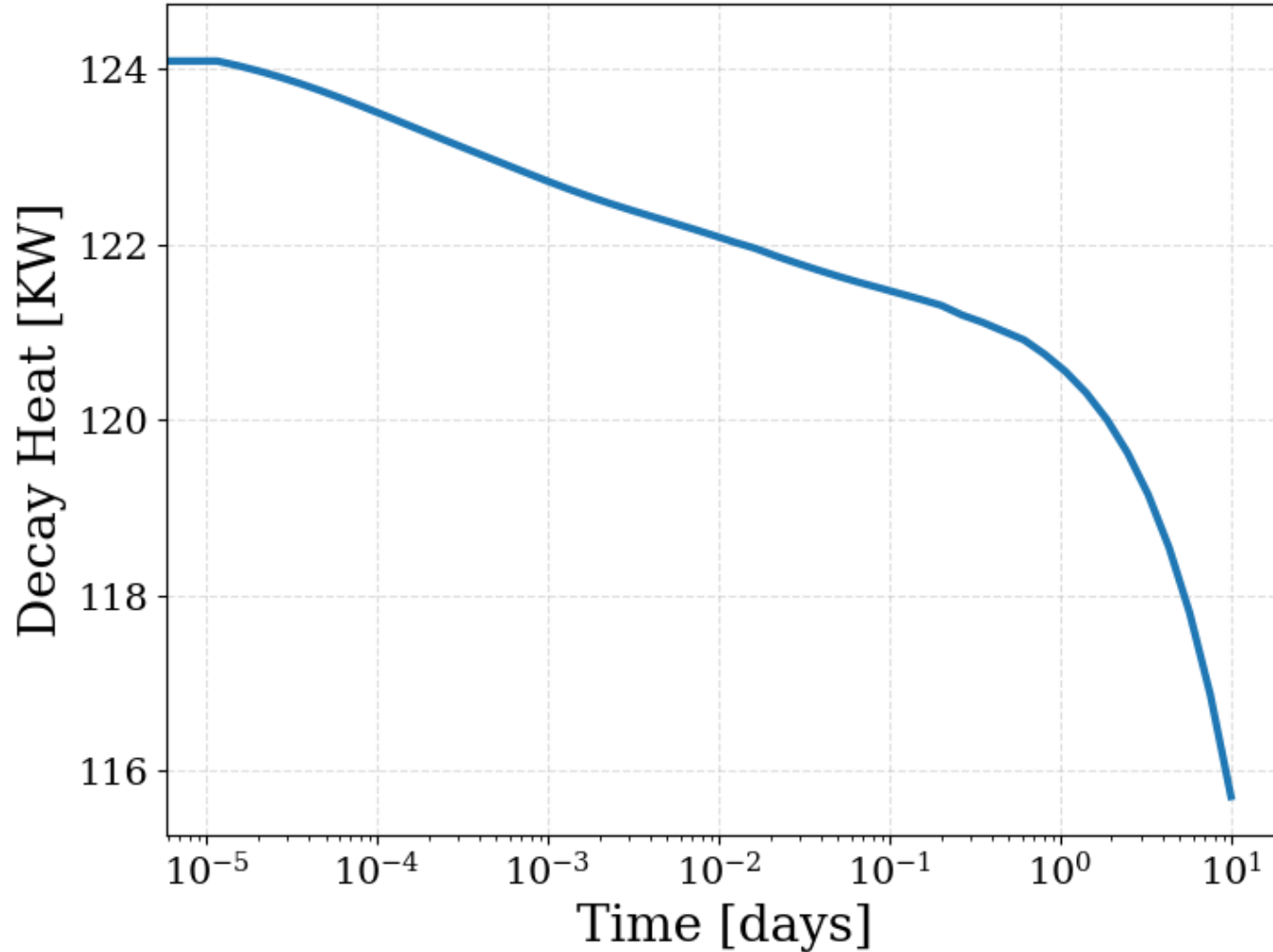

Total decay heat of spent fuel tank (620k pebbles)

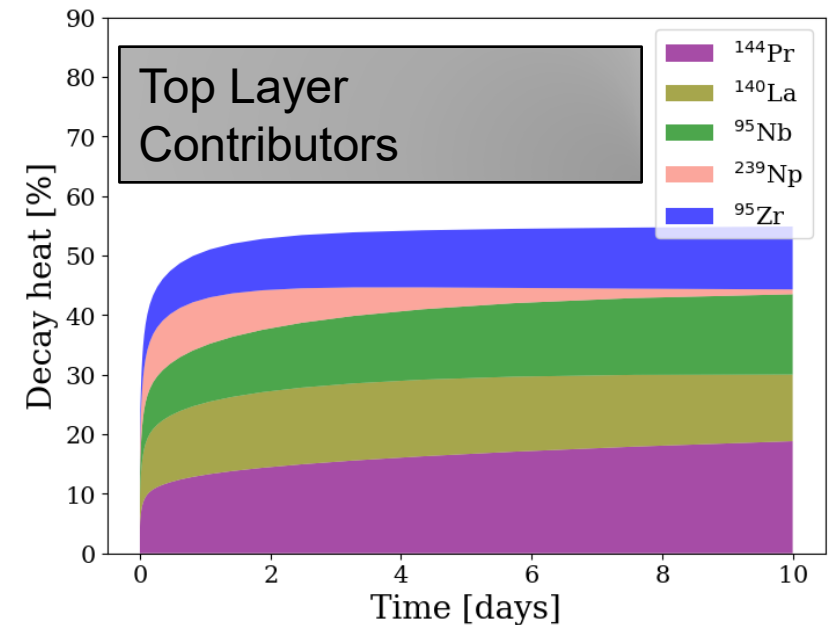
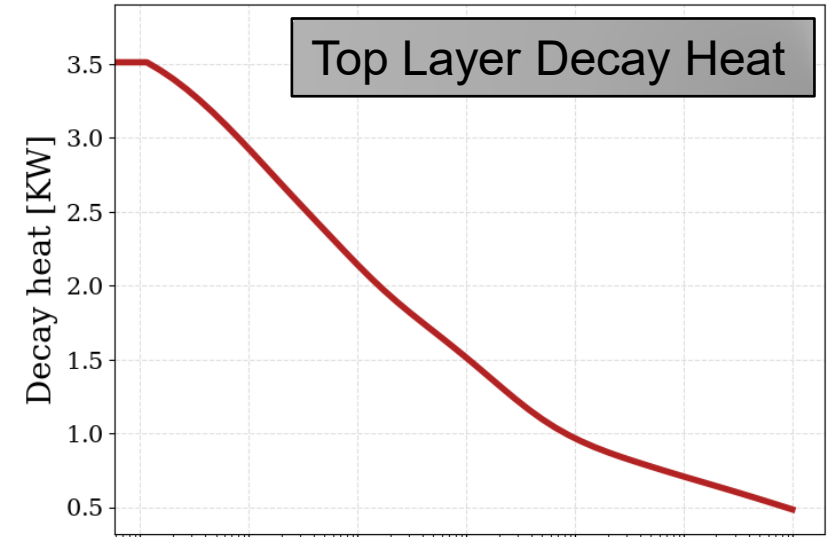
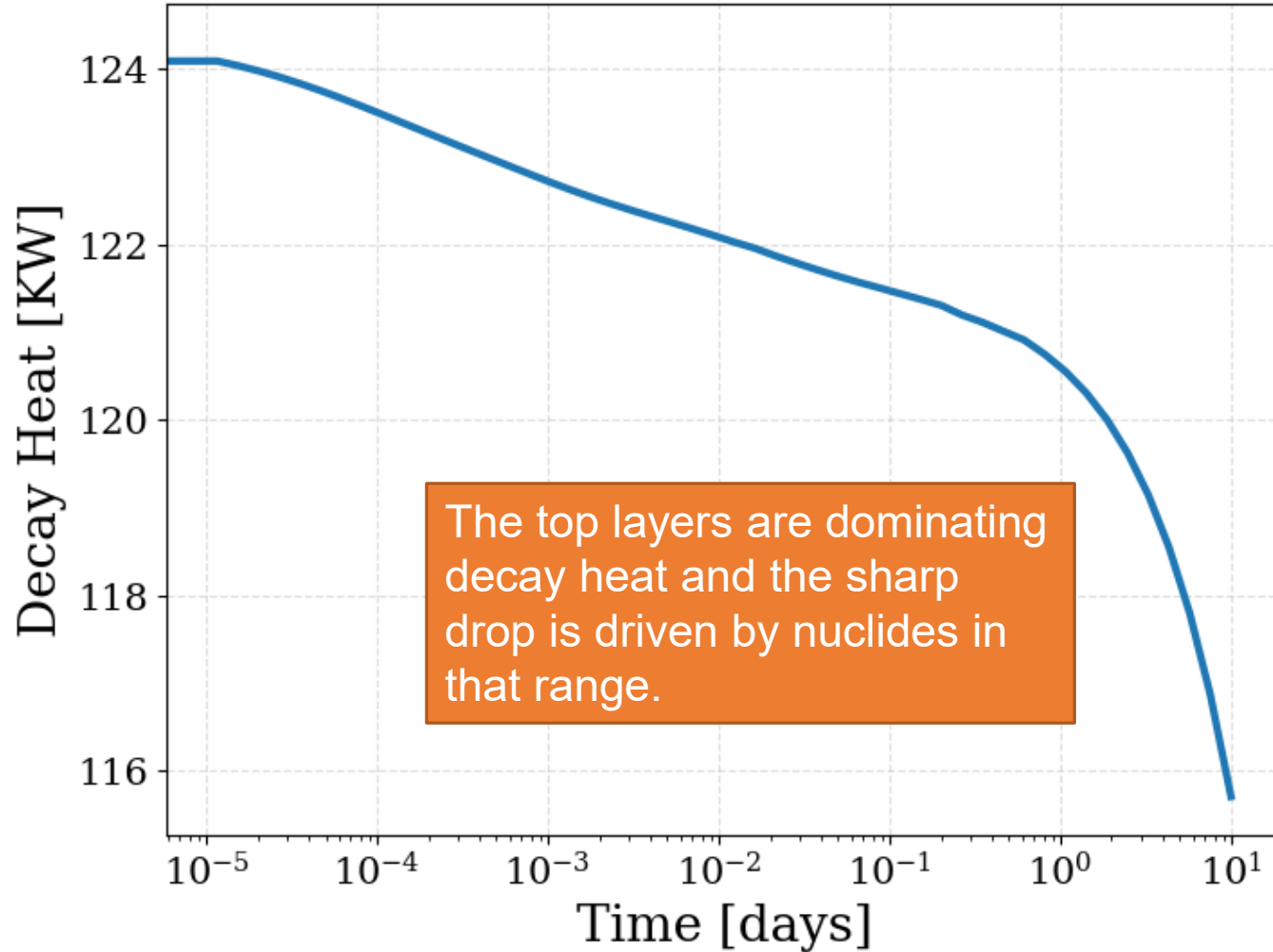

SCALE Summary



U.S. NRC



**Sandia
National
Laboratories**

Summary of HTGR fuel cycle hazard analysis – SCALE criticality, nuclide inventory, and decay heat

1. Water ingress into DN30-X UF₆ transportation packages

- With additional neutron absorbers, baseline infinite array of packages significantly subcritical, max $k_{\text{eff}} \sim 0.78$, even for 20 wt.% ²³⁵U enr.
- k_{eff} still shows large margin to criticality with any amount of water ingress

2. Damage/drop of a VP-55 fresh fuel pebble transportation package

- Small package with 350-400 pebbles per package
- Using PBMR-400 pebbles with ~10 wt.% enr., $k_{\text{eff}} \sim 0.3$; for 20 wt.% enr. $k_{\text{eff}} \sim 0.5$
- Strong impact of pebble packing fraction: 2,000 pcm increase with 5% packing fraction increase

3. Pipe rupture in FHSS

- 20,000 pebbles were simulated to yield variations in inventory/decay heat
- Actual accident progression to be handled by MELCOR using SCALE inventory data

4. Damage to SFT potentially causing loss of cooling and/or fission product release

- SFT inventory/decay heat generated using 20,000 pebble histories
- Actual accident progression to be handled by MELCOR using SCALE inventory data

Conclusions of SCALE analysis

- SCALE capabilities to simulate different scenarios in different fuel cycle stages were demonstrated.
- Analysis involved criticality calculations, fuel inventory and decay heat calculation, and radionuclide characterization. Results obtained are physically reasonable and follow expectations.
- SCALE has been well validated for criticality and reactor fuel depletion of water-moderated LEU systems*. Additional benchmarks are needed to extend validation to graphite-moderated and HALEU systems.
- Additional information is needed for improved analysis: commercial size transportation canisters for UF_6 and fuel pebbles, handling of fuel pebbles during operation (addition of fuel pebbles to the FHSS, extraction of fuel pebbles, etc.), onsite storage of spent fuel pebbles, etc.

* See SCALE validation reports: <https://www.ornl.gov/scale>

High-Temperature Gas-Cooled Reactor Modeling using MELCOR

Lucas I. Albright, Kenneth Wagner, David L. Luxat
SAND2023-12955PE



U.S. NRC



MELCOR HTGR Fuel Cycle Modeling

Fission product release and transport

- Release from TRISO kernel
- Radionuclide distributions within the layers in the TRISO particle and compact
- Release to coolant

Hazardous material release and transport

- U-bearing materials
- Corrosives

Other phenomenological models

- Graphite oxidation
- Intercell and intracell conduction
- Convection & flow
- Control function-based chemistry

6.1 PLANT LAYOUT

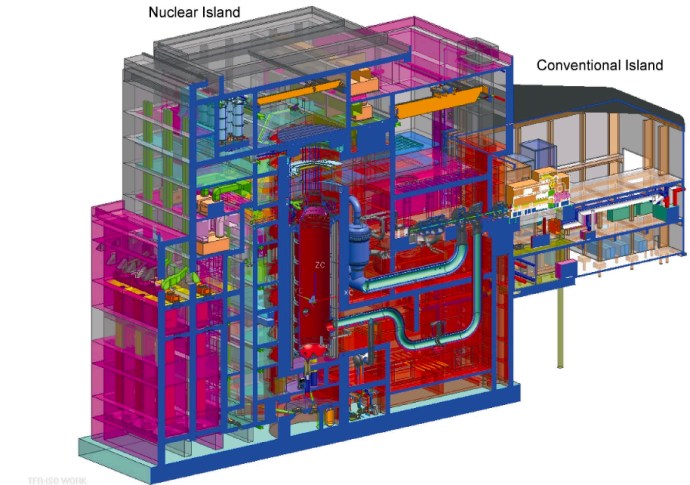

Figure 48: Plant Layout

Slabber (2006), Technical Description of the PBMR Demonstration Power Plant, <https://www.nrc.gov/docs/ML0609/ML060940293.pdf>

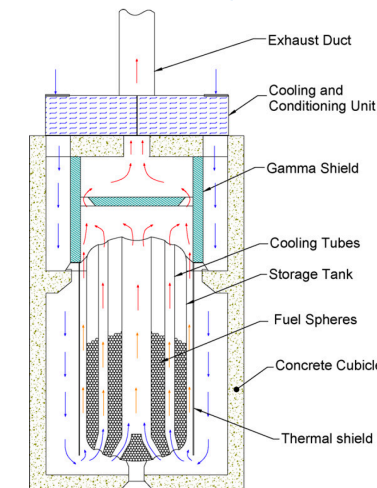

Fig. 1. Layout of the storage tank in its concrete cubicle.

Fuls, W.F., Mathews, E.H. (2006). Passive Cooling of the PBMR spent and used fuel tanks. *Nuclear Engineering and Design*, 237, 1354-1362.

Capability Demonstration

- The modeled systems and results are *representative* of prototypic HTGR fuel cycle systems and postulated accidents.
 - The modeled systems have been derived from conceptual designs
 - The calculations are intended to illustrate modeling capabilities
 - No safety judgments should be concluded

MELCOR Models and Simulations

A Short Summary of Facility Modeling with MELCOR

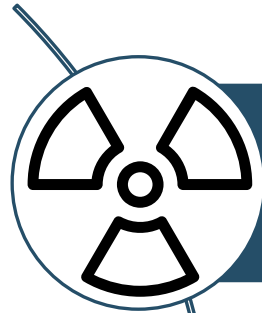

Source term and leak path factor analysis (aerosol physics, vapor physics, user-defined speciation and chemistry, etc)



Broad accident sequence spectrum (multi-room fire, explosions, spills, etc.)



Complex facility modeling (connectivity, interlocks, multi-zone ventilation and filtration, etc.)

or –

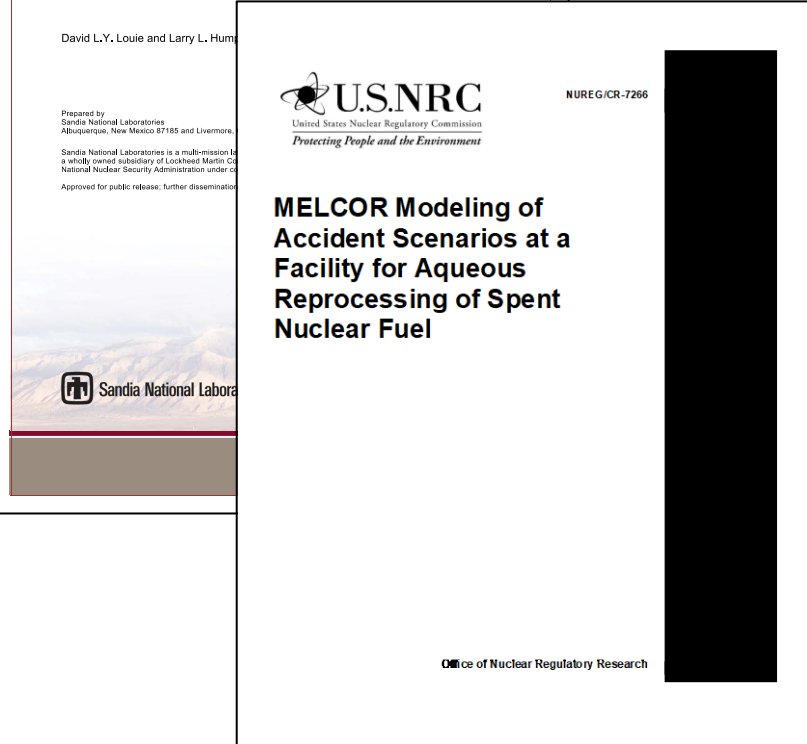
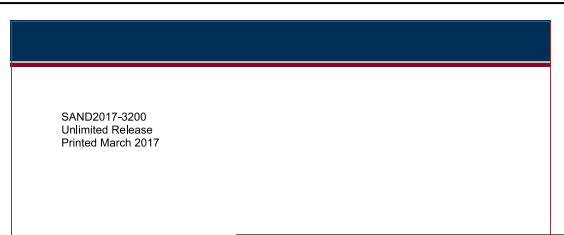

- MELCOR capabilities facilitate radiological and non-radiological hazard analyses

Facility

Demonstration Facility Model

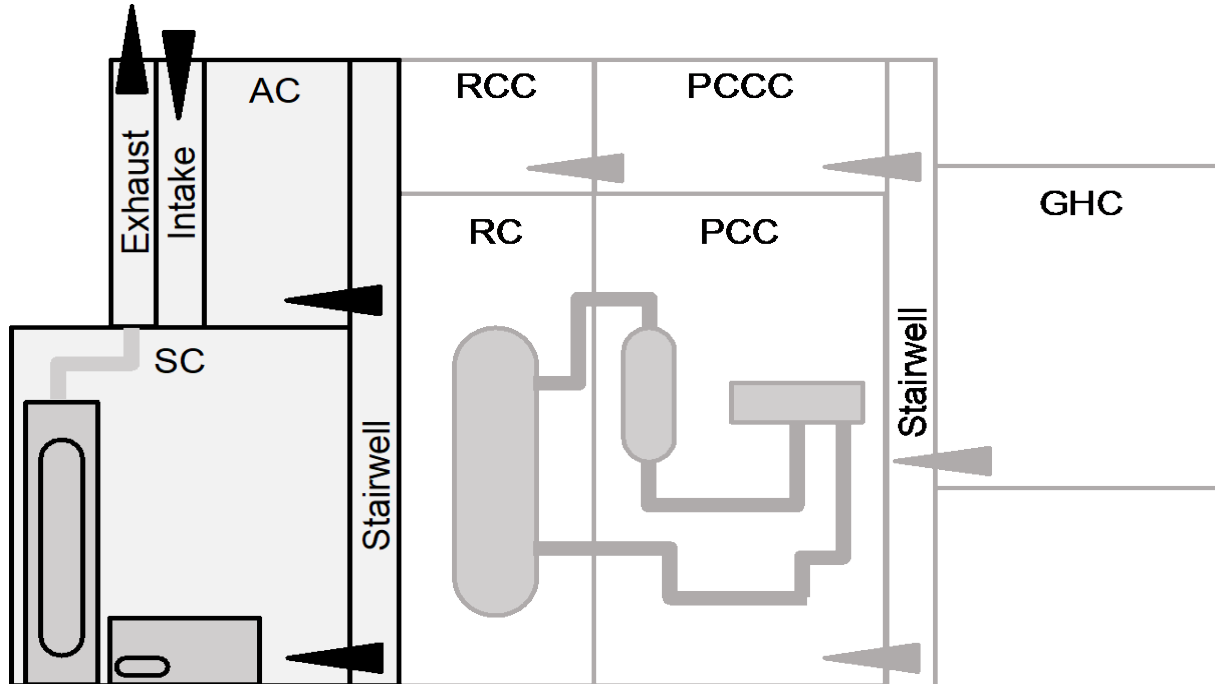

Demonstration facility overview with relative locations of fuel storage tank cubicle and UF₆ cylinder storage featured in the following slides

- Generator housing compartment (GHC)
- Power conversion compartment (PCC)
- Power conversion crane compartment (PCCC)
- Reactor compartment (RC)

6.1 PLANT LAYOUT

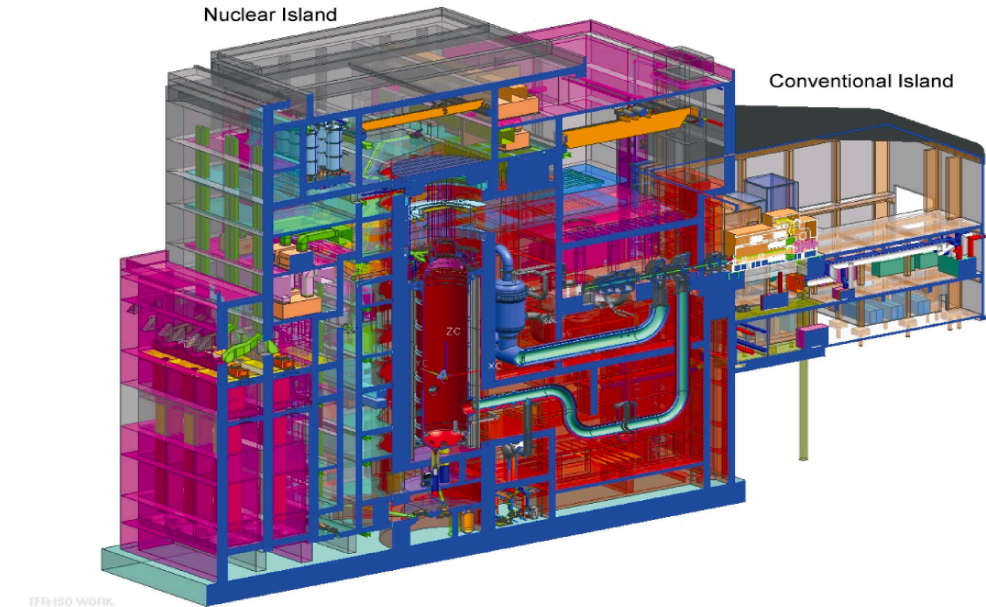
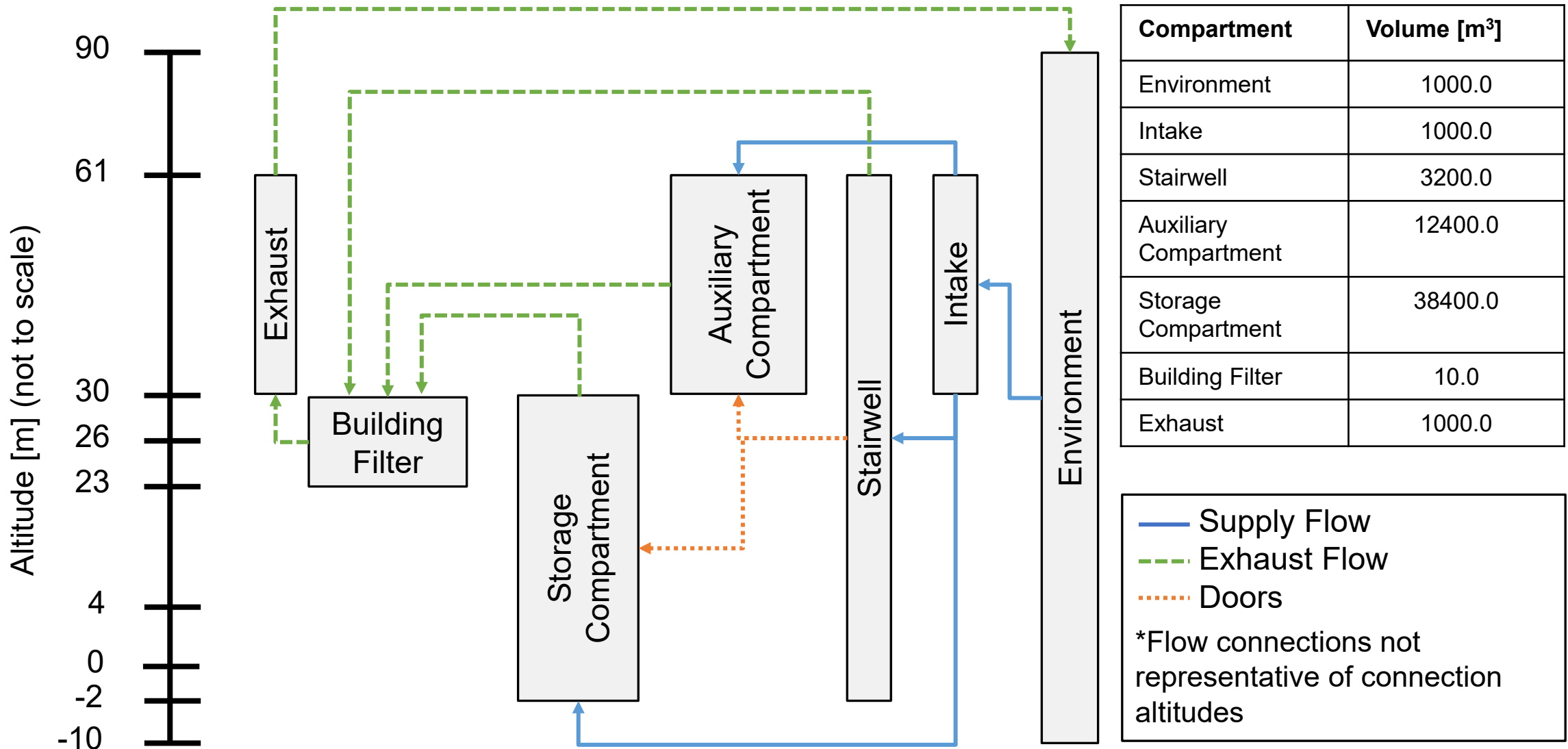

Figure 48: Plant Layout

Slabber (2006), Technical Description of the PBMR Demonstration Power Plant, <https://www.nrc.gov/docs/ML0609/ML060940293.pdf>

- Reactor crane compartment (RCC)
- Storage compartment (SC)
- Auxiliary Compartment (AC)

Facility Model Detail



Building Filter Detail

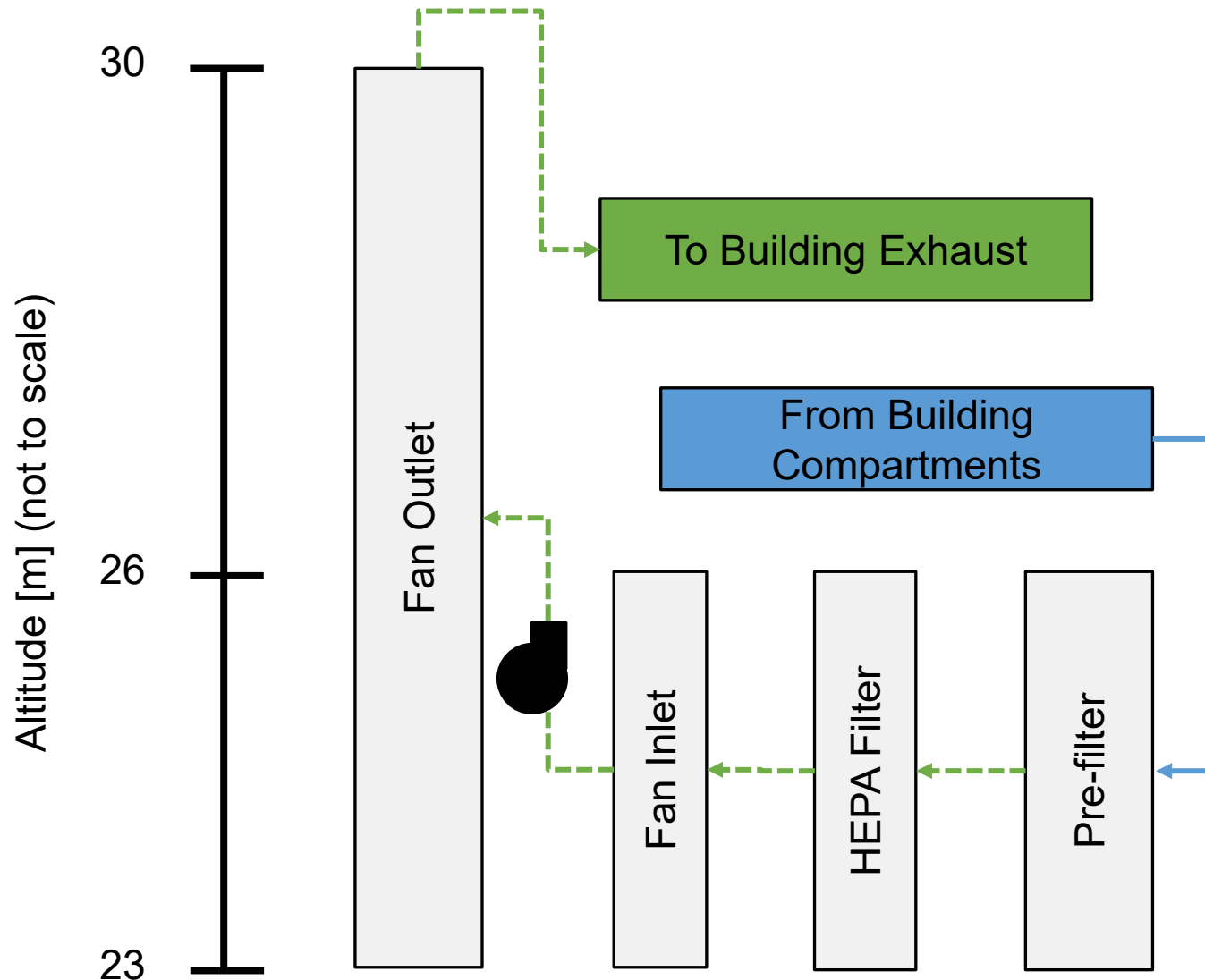

Compartment	Volume [m ³]
Pre-filter	5.0
HEPA	2.0
Fan Inlet	2.0
Fan Outlet	2.5
Specification	-
Fan ΔP [Pa]	100.0

— Supply Flow
- - - Exhaust Flow
 Fan
 *Flow connections not representative of connection altitudes

UF₆ Cylinder

E1: Enrichment – UF₆ Cylinder Rupture

Scenario Summary

- Overfilled model 48Y cylinder is heated resulting in tank rupture and UF₆ release as vapor and aerosol
 - NUREG/CR-6410 Scenario 6 – Case 1 (based on NUREG-1179)
- Rapid and complete release of massive quantity of UF₆
 - Flashing ratio = 0.45 vapor and 0.55 solid particles
 - $\text{UF}_6 + 2\text{H}_2\text{O} \rightarrow \text{UO}_2\text{F}_2 + 4\text{HF} + 117.147 \text{ kJ}/(\text{kg mol UF}_6)$

Demonstration Characteristics and Important Phenomena

- MELCOR modeling flexibility (reproduction of NUREG/CR 6410 analysis w/ MELCOR)
- Aerosol and vapor RN sources after tank rupture
- Material transport by and NCG/CVH package
- Material transport by RN package
- Control function-based species chemistry

Demonstration UF₆ Cylinder

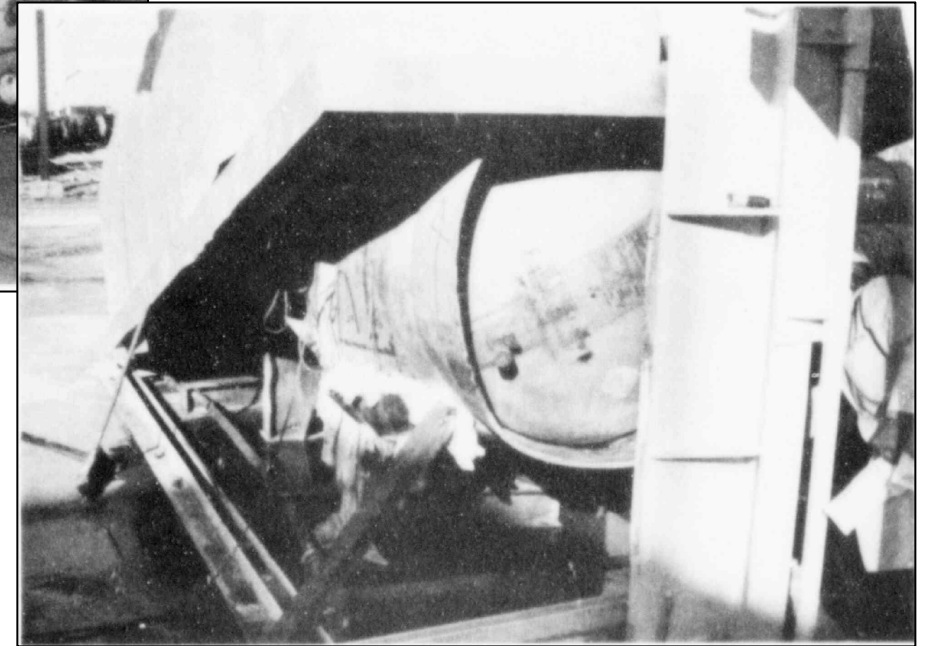
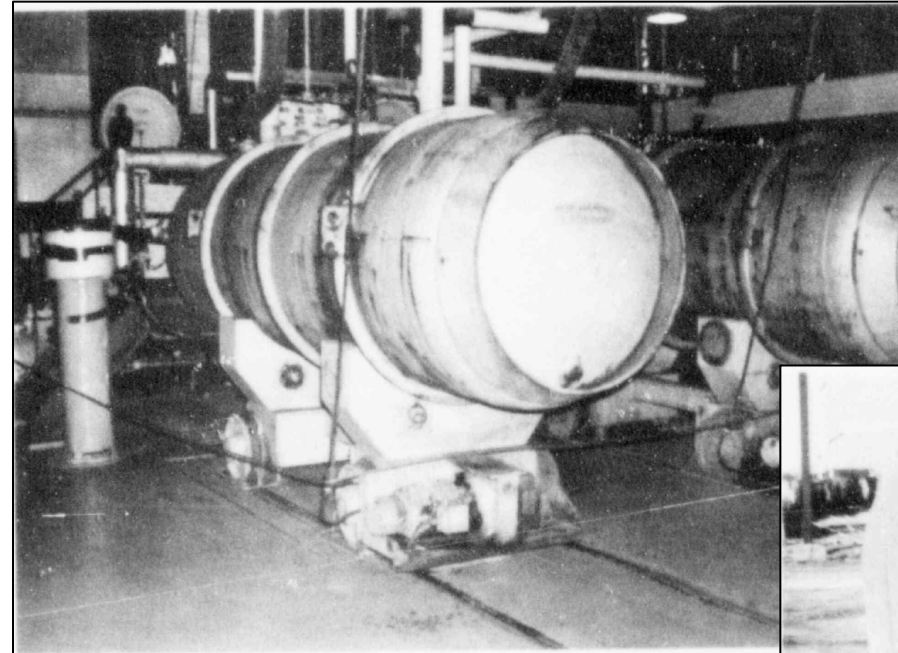
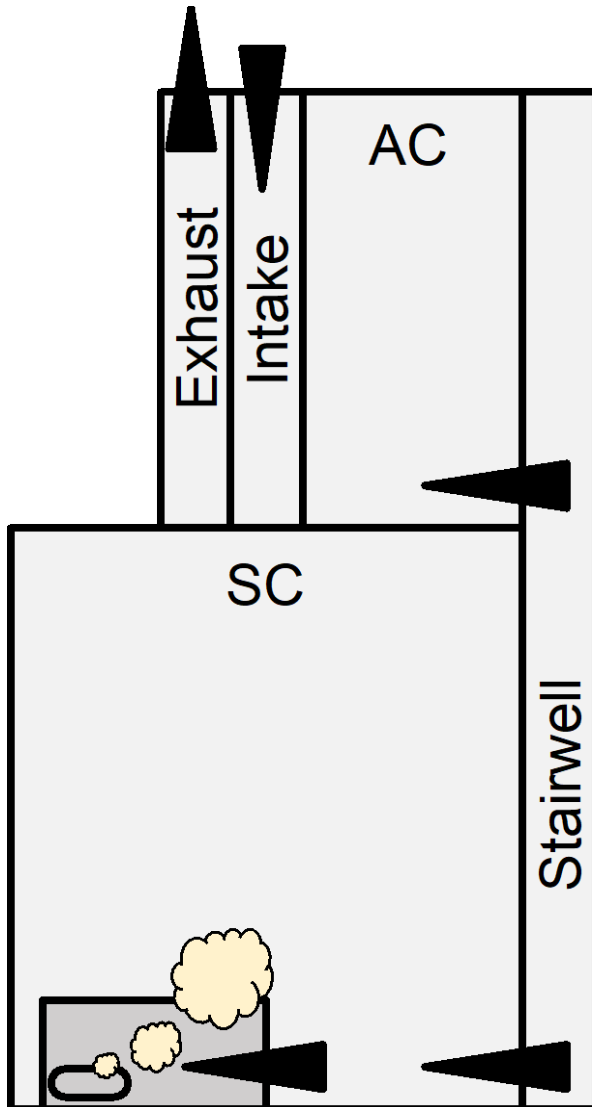

U.S. Nuclear Regulatory Commission (1986). Rupture of Model 48 UF₆ Cylinder and Release of Uranium Hexafluoride. NUREG-1179, Volume 1, U.S Nuclear Regulatory Commission

UF₆ Cylinder Detail

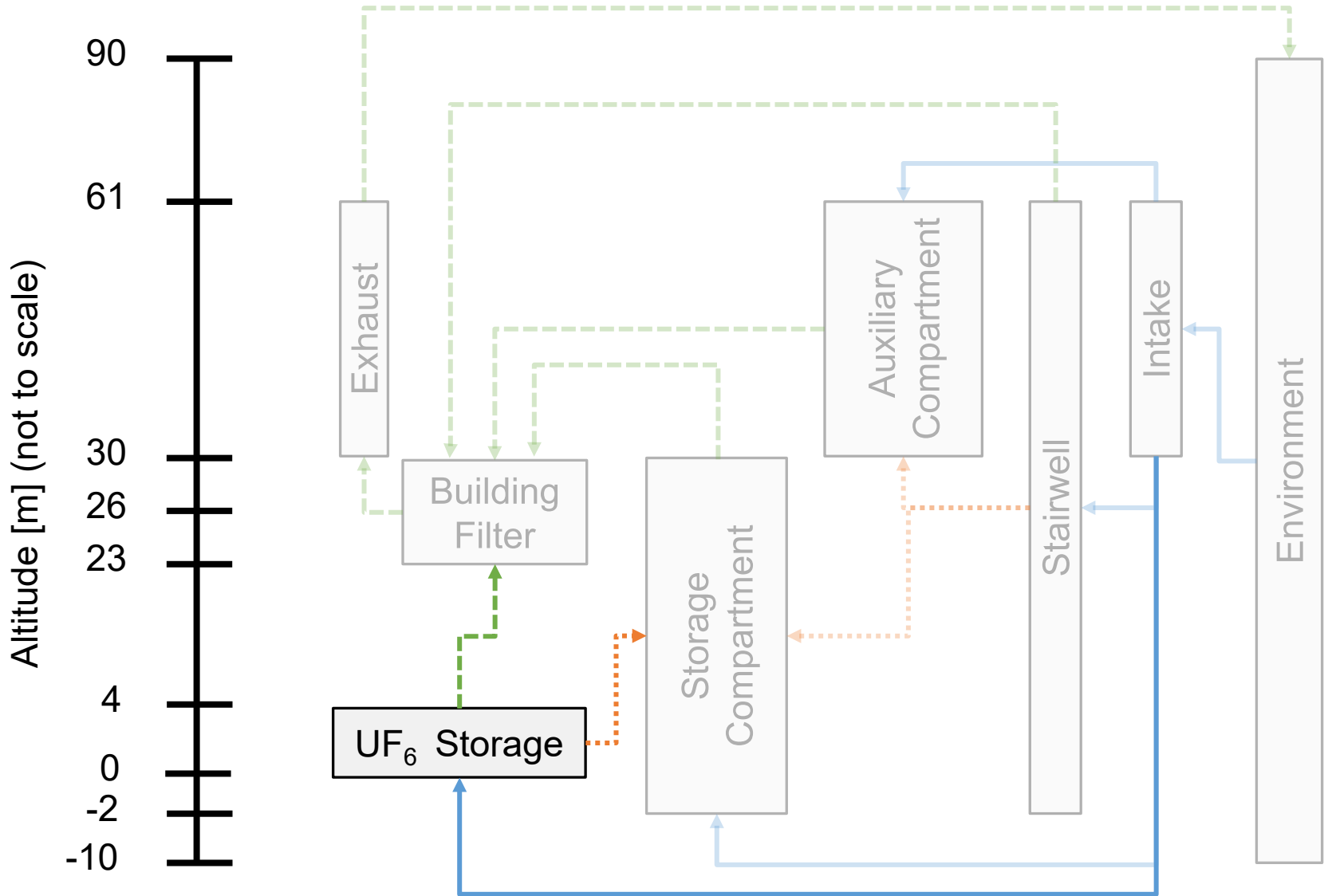

Compartment	Volume [m ³]
UF ₆ Storage	1000.0
Specification	-
UF ₆ release mass [kg]	14000
Flashing Ratio	0.45 vapor/0.55 aerosol
Building Relative Humidity	0.4
Release Duration [s]	1.0 x 10 ⁻³
Door Open Fraction	1.0

— Supply Flow
- - - Exhaust Flow
. . . Doors
 *Flow connections not representative of connection altitudes

UF6 Cylinder – Catastrophic Rupture

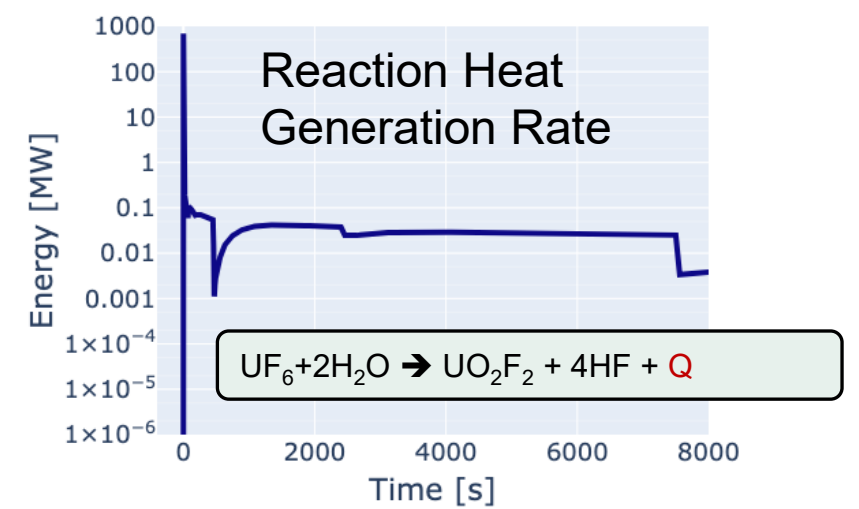
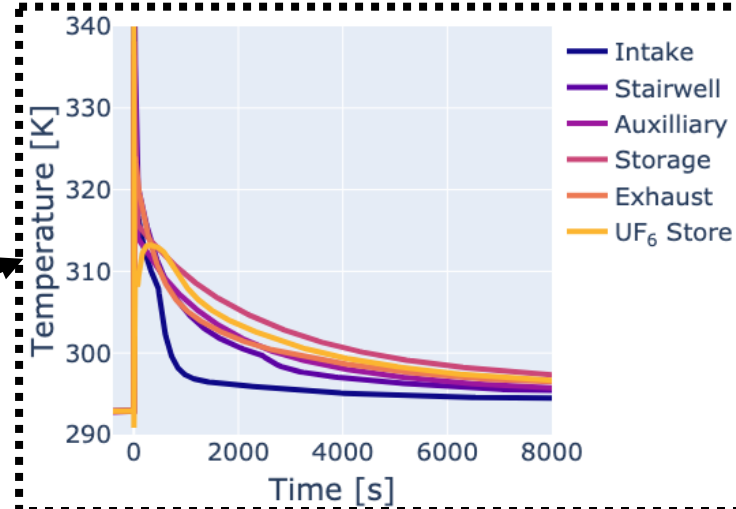
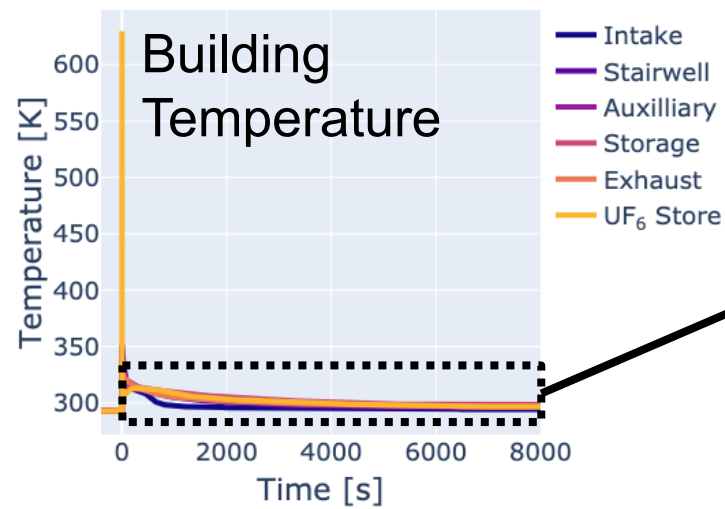
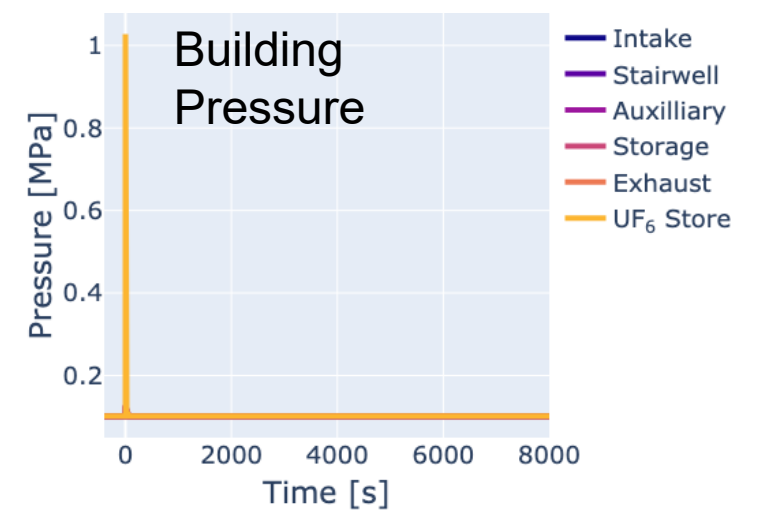
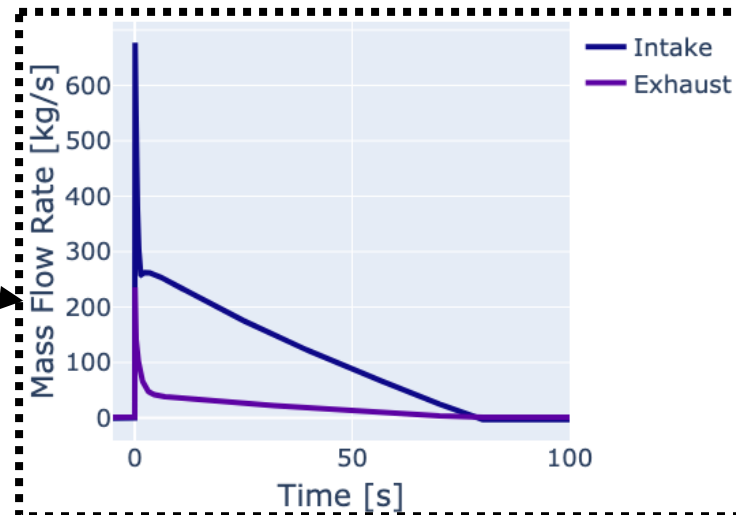
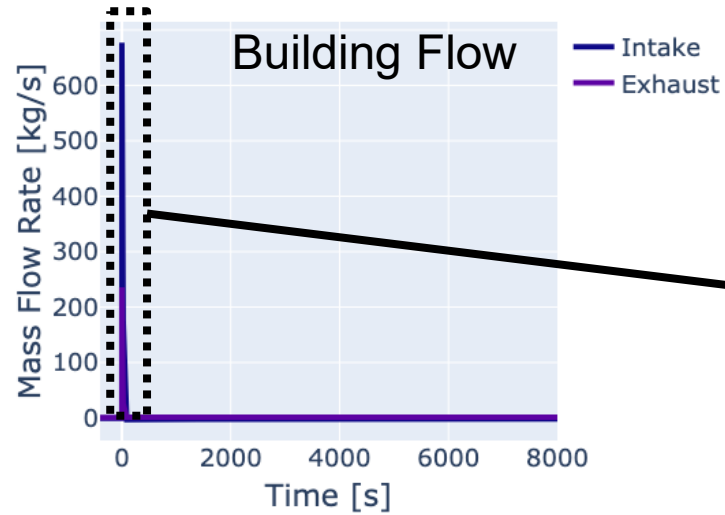

- Rupture event causes a large pressure spike and mass ejection to atmosphere through building openings
- Elevated building temperatures are observed after the rupture and are sustained by exothermic reactions

UF6 Cylinder – Catastrophic Rupture Continued

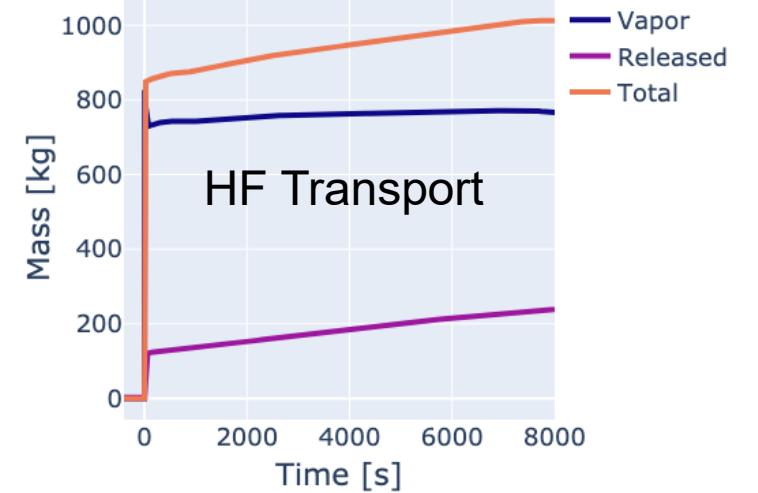
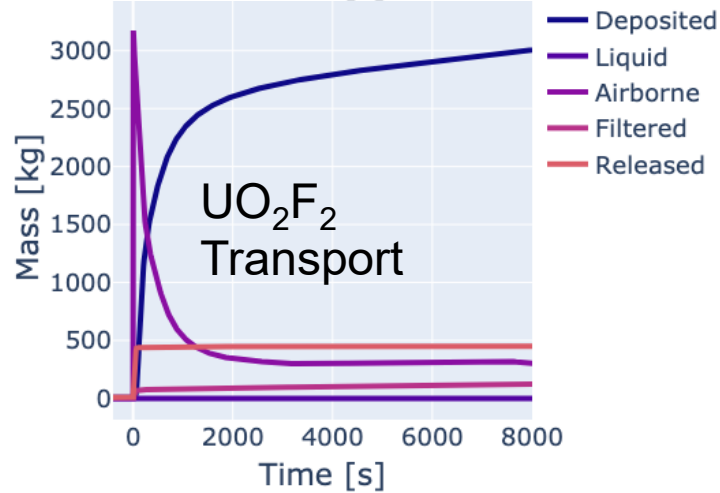
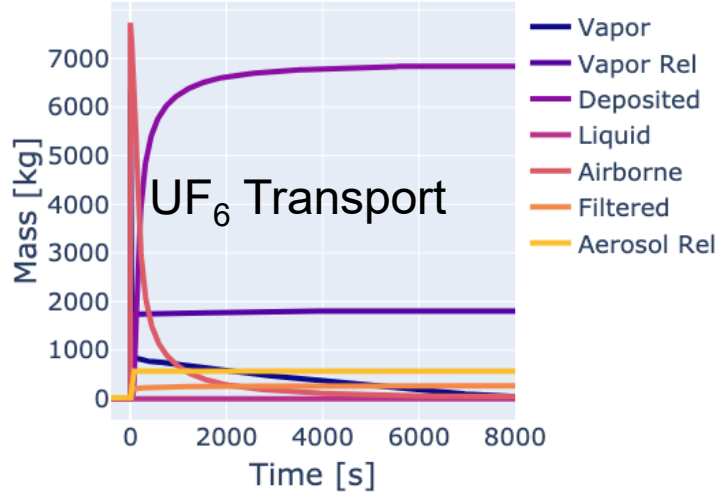
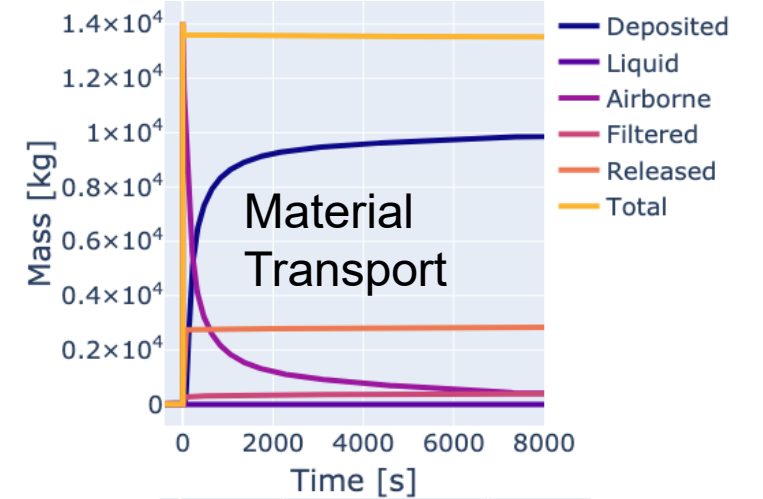
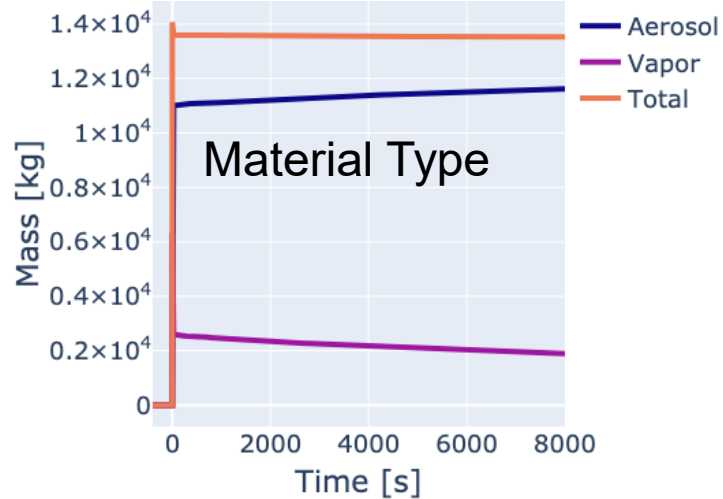
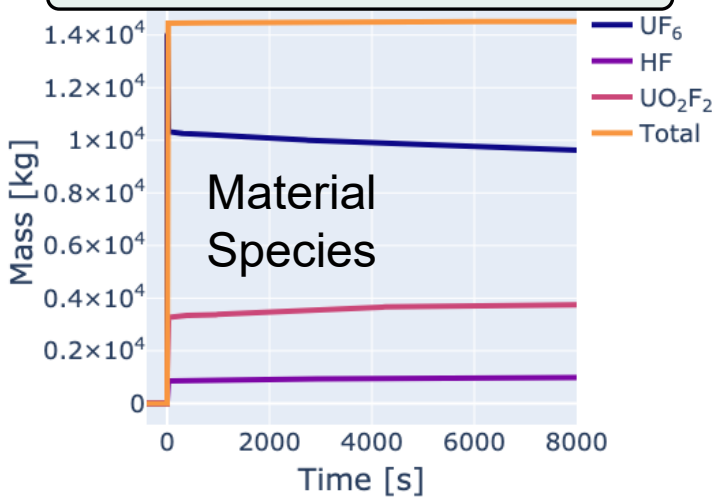

- U-bearing mass released primarily during initial rupture event, minimal releases observed thereafter
- U-bearing masses are primarily aerosol and exhibit strong tendency to deposit on building structures

UF_6 Cylinder Sensitivities

UF6 Cylinder Sensitivity Specification

Model	Parameter	Distribution	Range
Model Parameters	Vapor Fraction	uniform	0.0 – 1.0
	Release Duration	log-uniform	1.0e-6 – 600.0
	UF ₆ Storage Door Area Multiplier	uniform	0.01 – 1.0
	Relative Humidity	uniform	0.01 – 0.99

Quantities Of Interest

Released U-bearing Mass

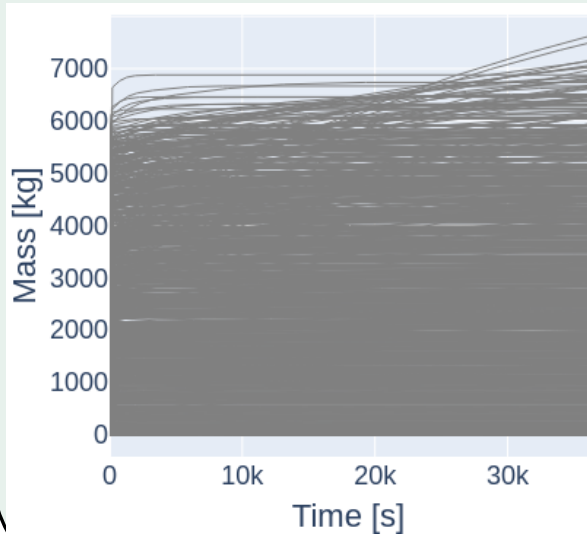

Filtered U-bearing Mass

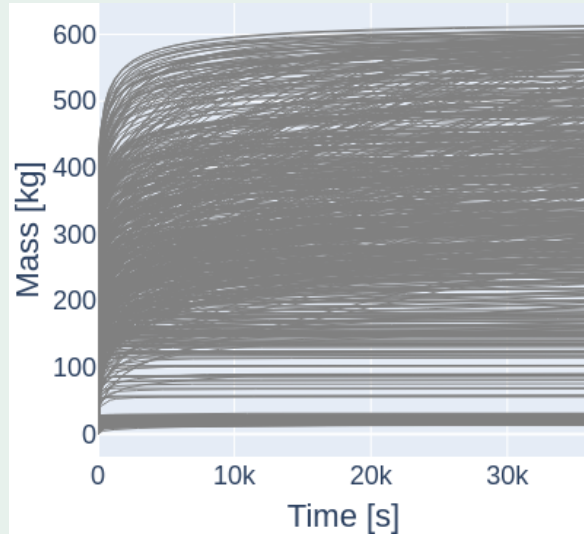

Released HF Mass

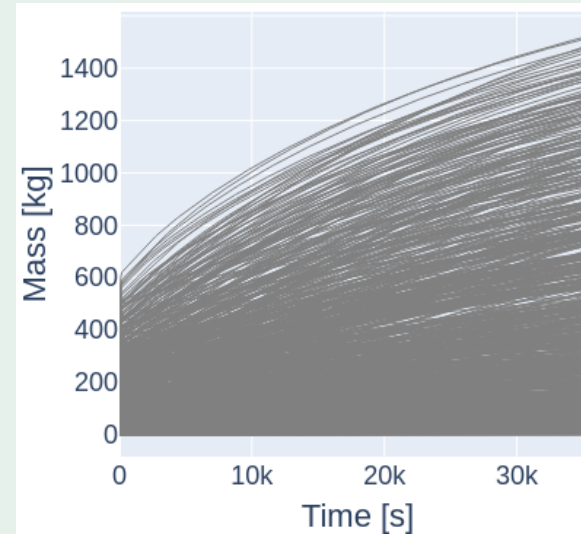

Reaction Heat Generation Rate

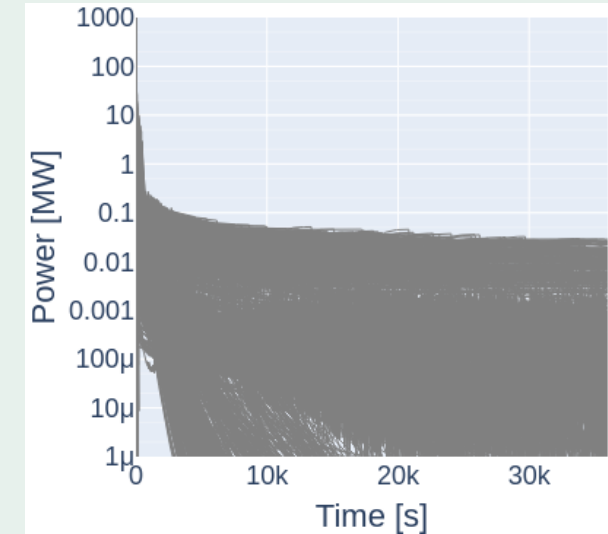

Model Sensitivities to Peak Quantities of Interest

Released U-bearing Mass

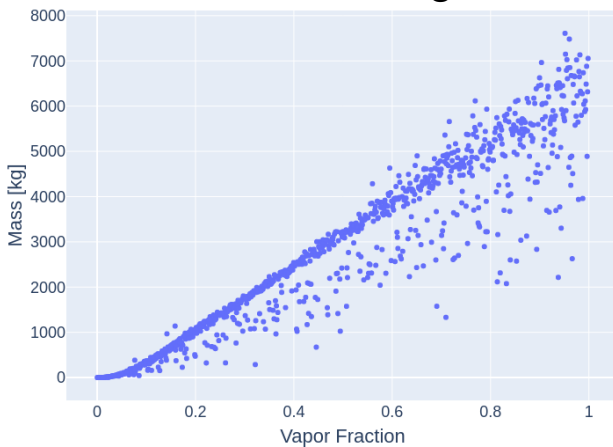

Filtered U-bearing Mass

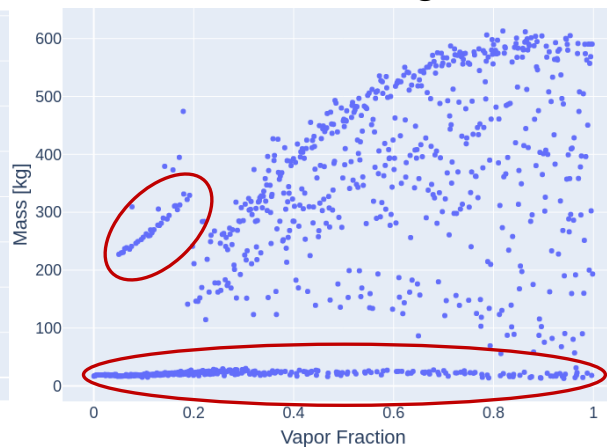

Released HF Mass

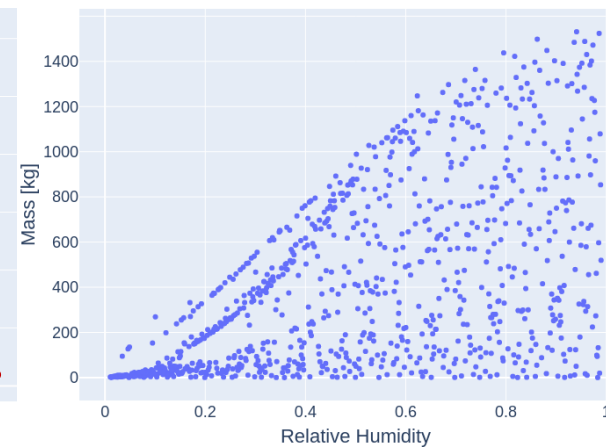

Reaction Heat Generation Rate

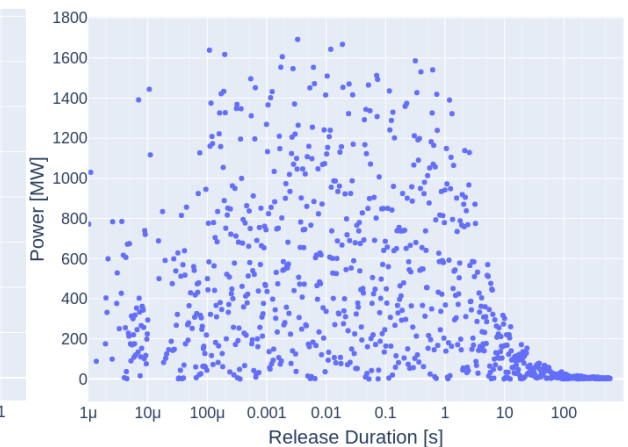

- No quantities of interest exhibit notable correlation to the door open area fraction
- Vapor fraction exhibits a strong, positive correlation to quantities of interest
- Relative humidity exhibits a strong impact on quantities of interest
- Weaker negative correlation to release duration is exhibited for quantities of interest for release durations <100s, correlation strength increases for release durations >100s

Fuel Storage Tank

Demonstration Fuel Storage

Spent Fuel: Retired fuel that has reached a specified burnup and cannot be reloaded into the core

Used Fuel: Fuel that has not reached the specified burnup and can be reloaded into the core

- May require temporary storage during core maintenance

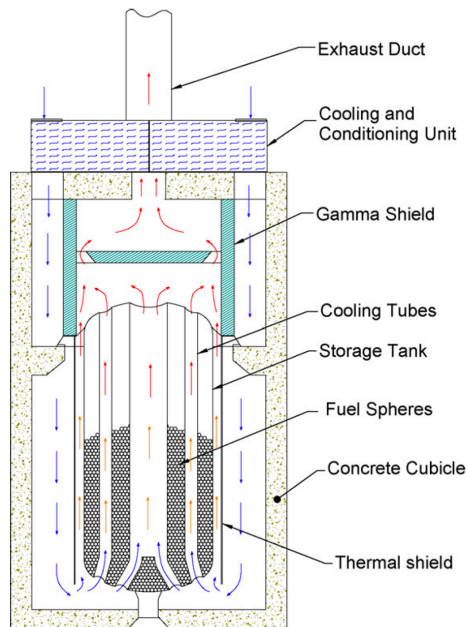
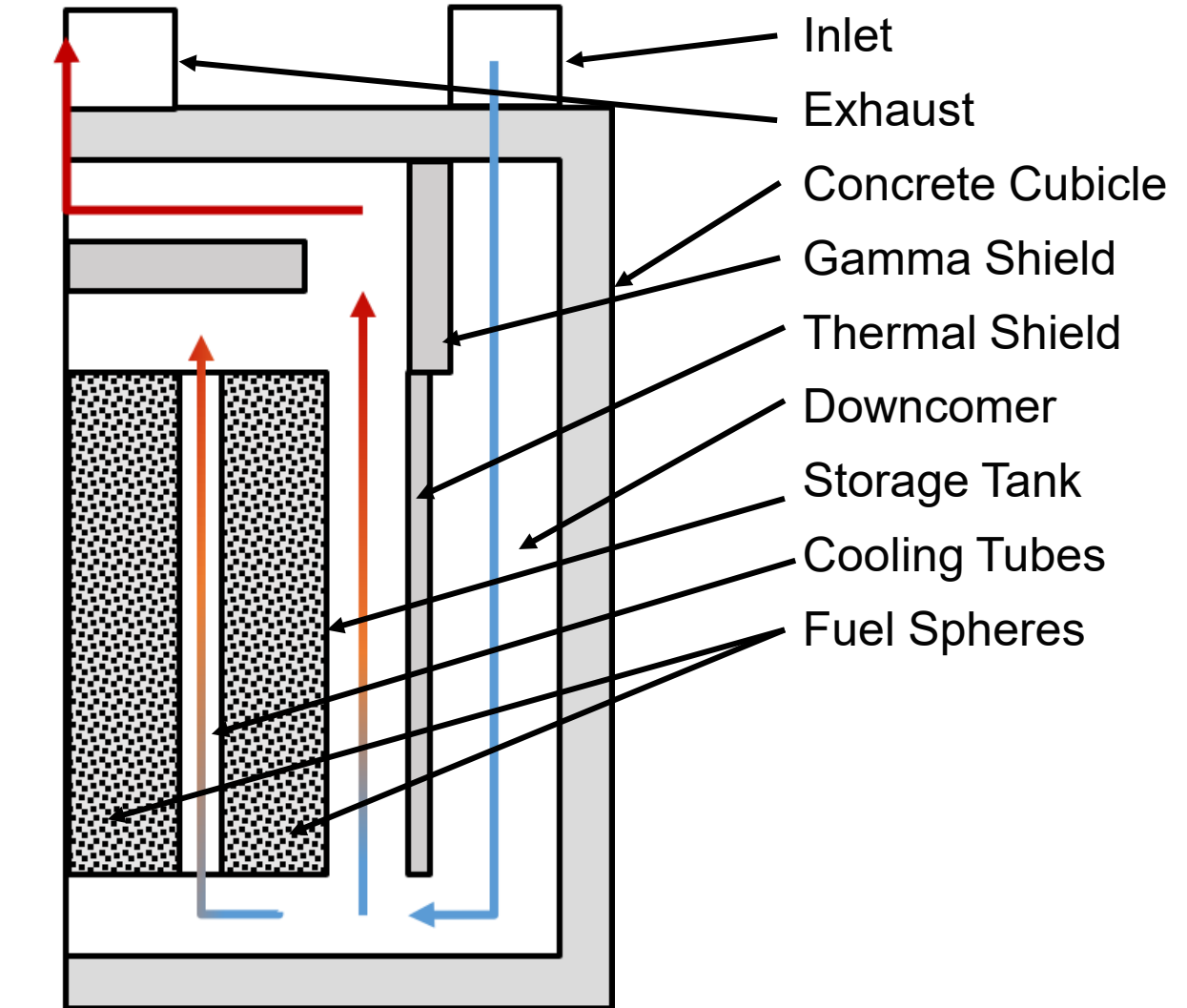

Fig. 1. Layout of the storage tank in its concrete cubicle.

Fuls, W.F., Mathews, E.H. (2006). Passive Cooling of the PBMR spent and used fuel tanks. *Nuclear Engineering and Design*, 237, 1354-1362.



MELCOR fuel storage tank concept overview with designated coolant flow

Demonstration Fuel Storage: Operational Modes

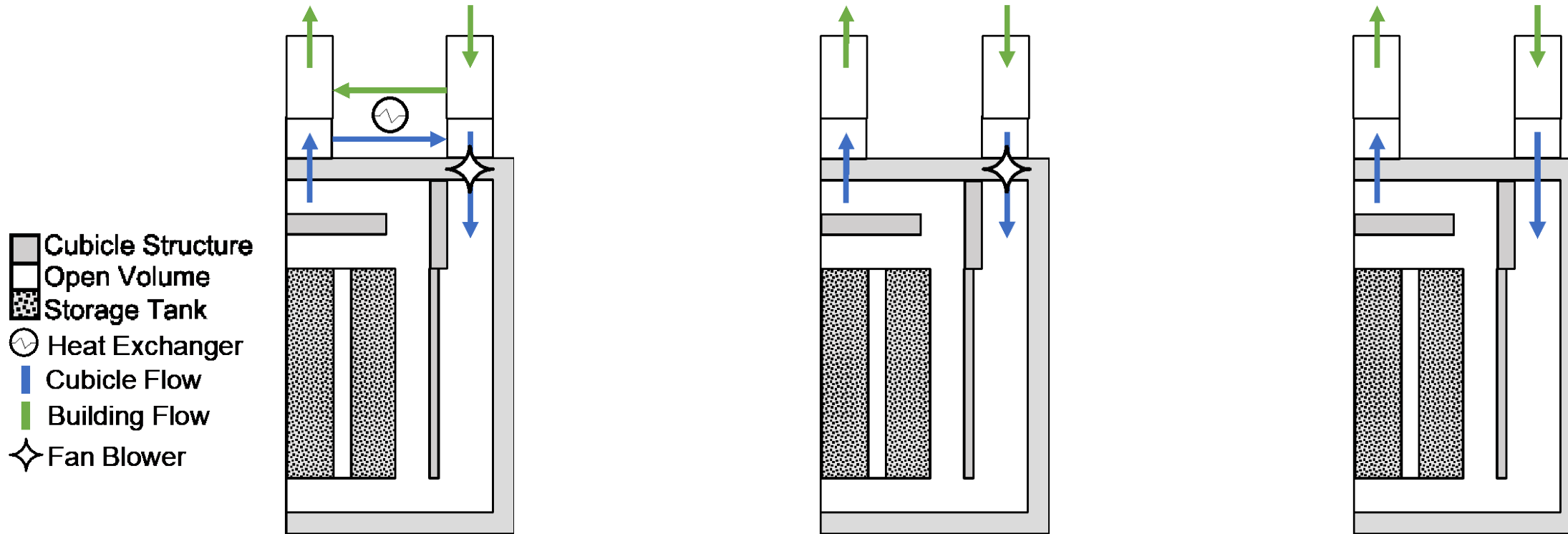

Closed Loop Active Cooling

- Normal operational mode for *spent* fuel storage tanks
- nominal decay heat ~140kW
- Building flow is isolated from concrete cubicle flow

Open Loop Active Cooling

- Normal operational mode for *used* fuel storage tanks
- nominal decay heat ~640kW
- Concrete cubicle draws on building air supply

Open Loop Passive Cooling

- On loss of power, louvres open (transition from closed to open loop) and/or active cooling is lost (*spent* or *used* fuel, respectively)

Cubicle Model Additions

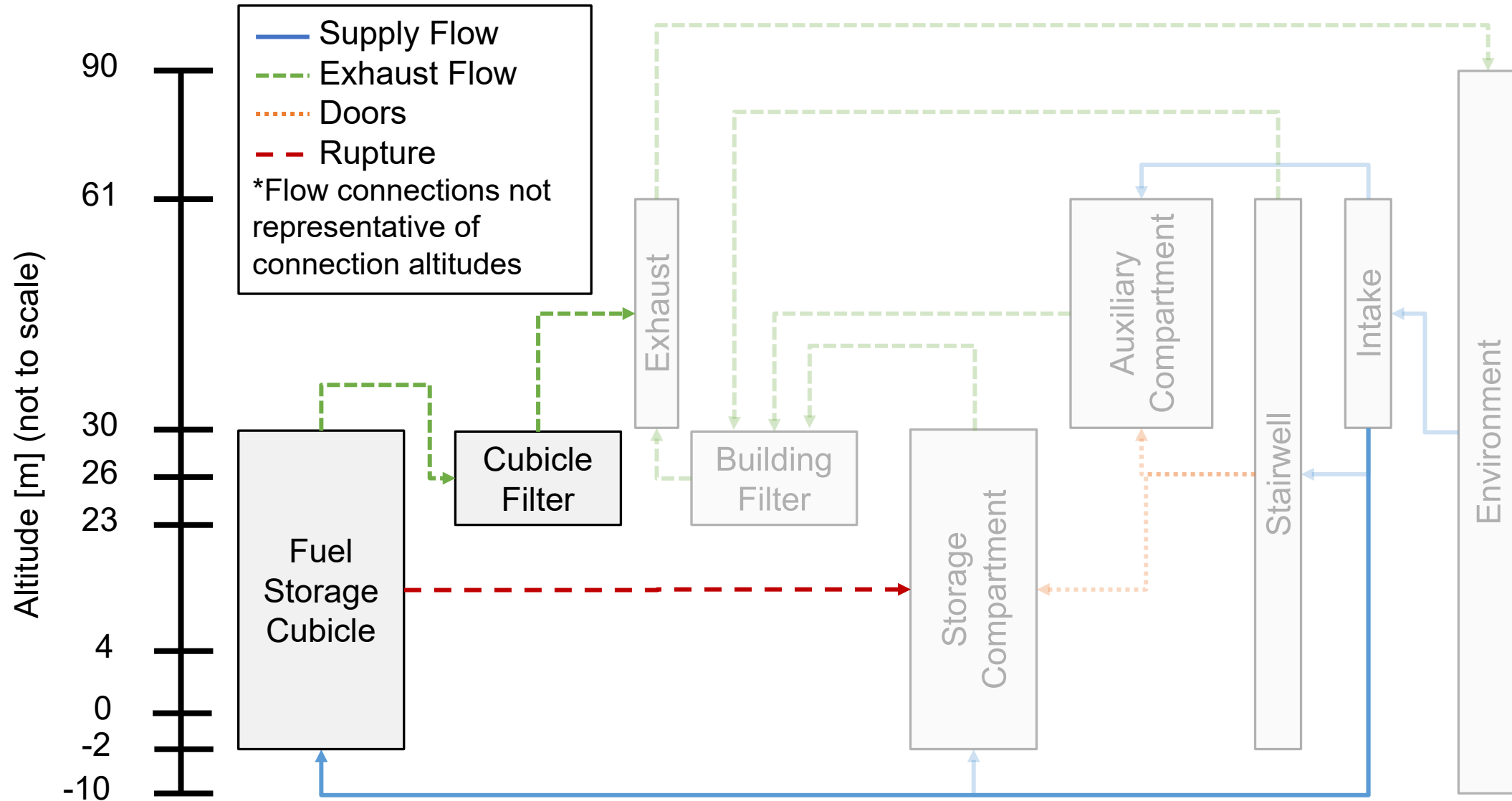

Fuel Storage Cubicle Detail

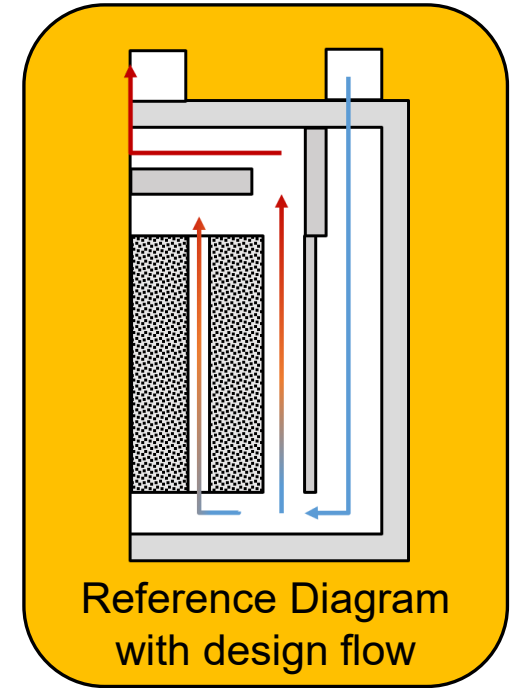
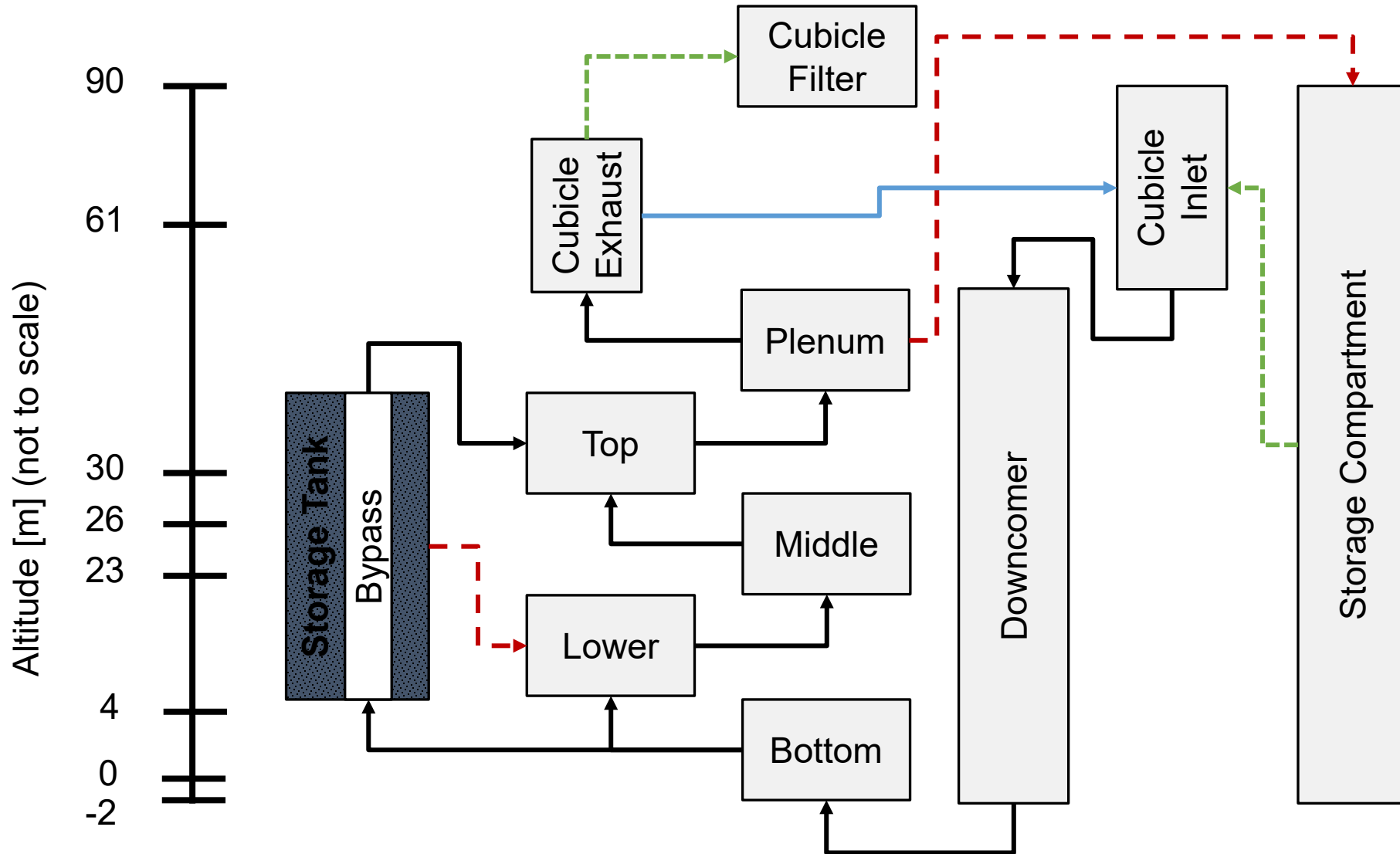

- Closed Loop Flow
- - - Open Loop Flow
- - - Rupture

*Flow connections not representative of connection altitudes

Fuel Storage Tank Detail

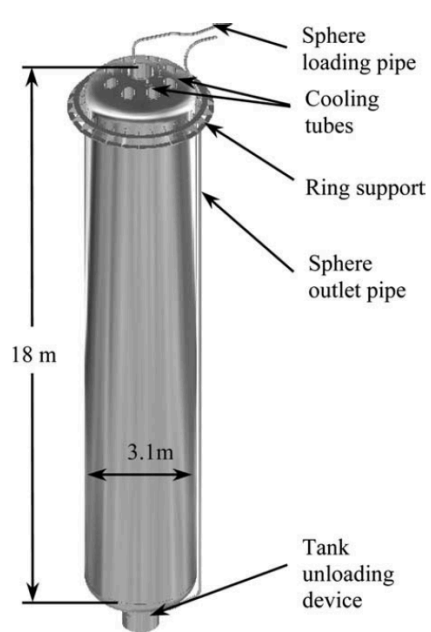
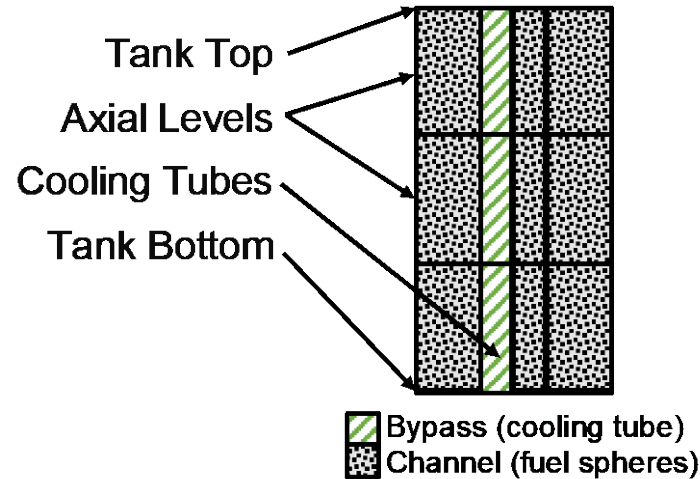
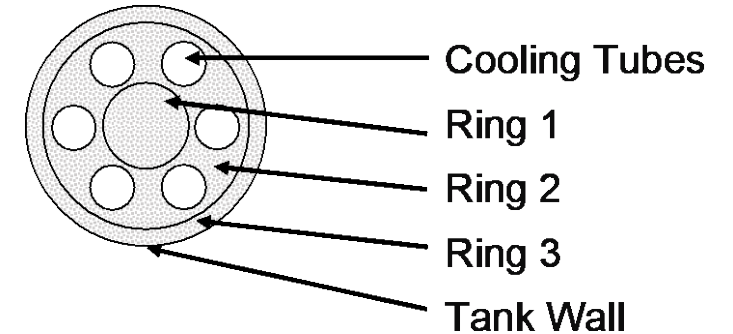

Fig. 1. Pictorial view of a typical storage tank.



Fuel storage tank axial nodalization



Fuel storage tank radial nodalization

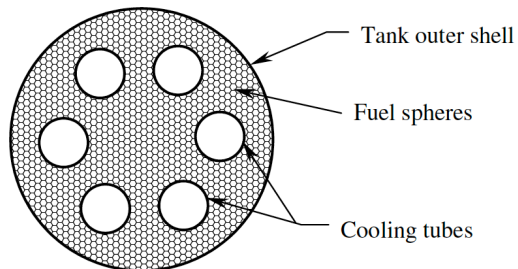
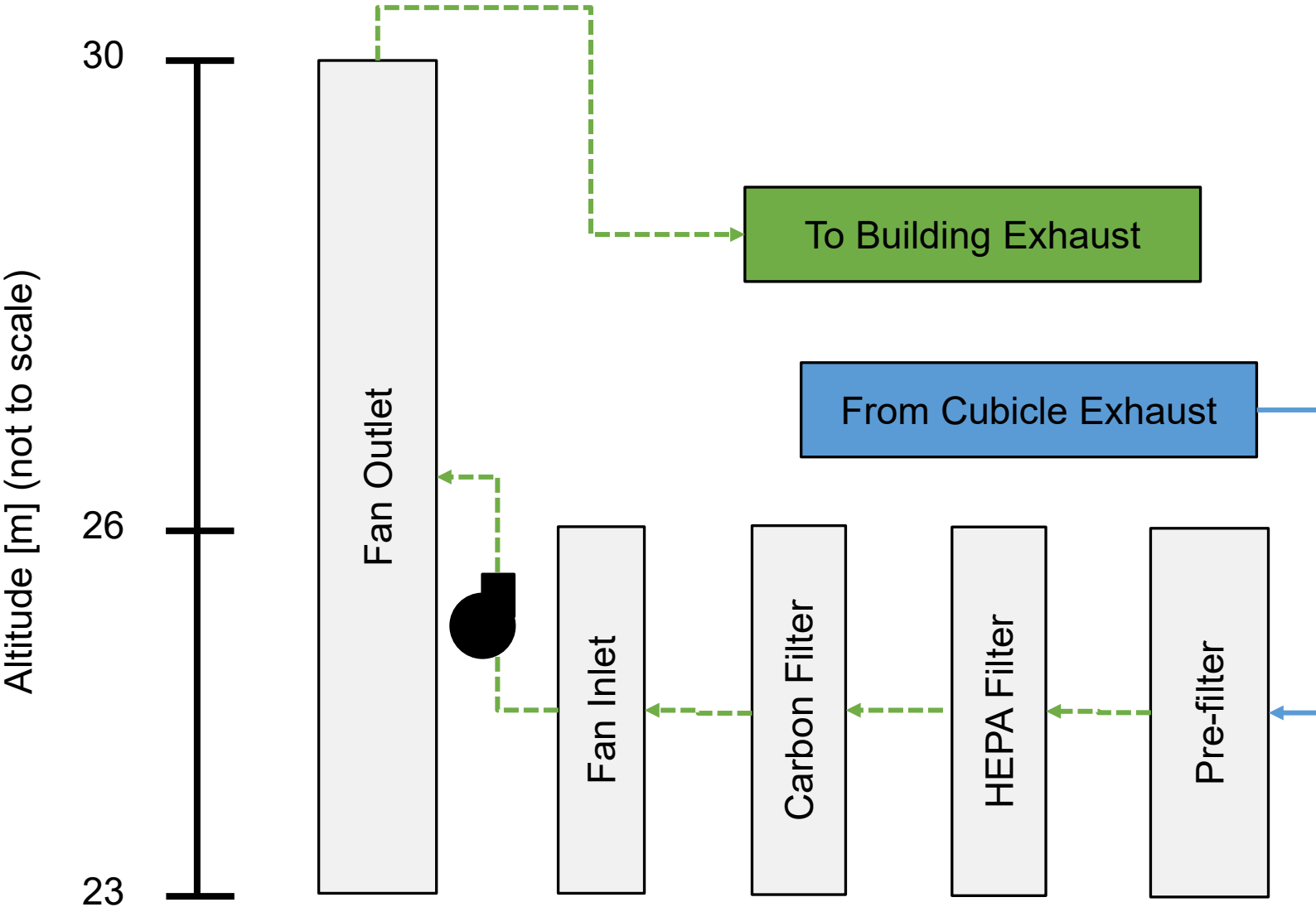

Fig. 2. Typical storage tank cross-sectional geometry.

Compartment	Volume [m ³]
Concrete Cubicle	800.0
Fuel Storage Tank	70.0
Specification	-
Used Fuel cubicle fan ΔP with filter [Pa]	2000.0
Used Fuel cubicle fan ΔP without filter [Pa]	100.0
Spent Fuel Fan ΔP [Pa]	10.0
Heat Exchanger Power	Logarithmic Mean Temperature Difference

Cubicle Filter Detail



Compartment	Volume [m ³]
Pre-filter	5.0
HEPA	2.0
Carbon	2.0
Fan Inlet	2.0
Fan Outlet	2.5
Specification	-
Fan ΔP [Pa]	100.0

— Supply Flow
- - - Exhaust Flow
 Fan
 *Flow connections not representative of connection altitudes

Postulated Scenario “Event Tree”

Fuel Type	Cubicle Filtration	Electric Power	Transient Operational Mode	Forced Flow	Active Heat Removal	Tank Intact	Cubicle Intact	Scenario Name
Used Fuel	No	Yes	Open Loop Active Cooling	Yes	Yes	Yes	Yes	Normal Operations Without Cubicle Filtration
			Closed Loop Active Cooling	Yes	Yes	Yes	Yes	Spurious Closure Without Cubicle Filtration
		No	Open Loop Passive Cooling	No	No	Yes	Yes	Loss of Power Without Cubicle Filtration
	Yes	Yes	Open Loop Active Cooling	Yes	Yes	Yes	Yes	Normal Operations With Cubicle Filtration
			Closed Loop Active Cooling	Yes	Yes	Yes	Yes	Spurious Closure With Cubicle Filtration
		No	Open Loop Passive Cooling	No	No	Yes	Yes	Loss of Power With Cubicle Filtration
Spent Fuel	Yes	Yes	Closed Loop Active Cooling	Yes	Yes	Yes	Yes	Normal Operations
							No	Cubicle Rupture
						No	Yes	Tank Rupture
							No	Tank and Cubicle Rupture
	No	No	Open Loop Passive Cooling	No	No	No	Yes	Heat Exchanger Failure
							Yes	Fan Failure
							Yes	Fan and Heat Exchanger Failure
							Yes	Loss of Power
						No	No	Loss of Power, Tank Rupture, and Cubicle Rupture

- MELCOR flexibility facilitates exploration of large event spaces

Used Fuel Storage Tank

U2: Utilization/Online Refueling – Used Fuel Storage Tank Transients

Scenario Summaries

- **Normal operations** – open loop active cooling
- **Spurious loop closure** – transition from open loop active cooling to closed loop active cooling resulting in limited airflow through the used fuel cubicle and subsequent heatup
- **Loss of power** – transition from open loop active cooling to open loop passive cooling resulting in reduced airflow through the used fuel cubicle and subsequent heatup
- **Sensitivities without cubicle filtration** – smaller fans can be used to develop similar cubicle flows when there is not a cubicle filtration system (system description does not indicate presence of filtration system)

Demonstration Characteristics and Important Phenomena

- Fuel radionuclide inventory development using SCALE
- TRISO modeling for non-reactor geometries
- Thermal hydraulics
- Used fuel storage tank operational modes and transients
- RN release and subsequent RN transport

Fuel Storage Tank – Used Fuel w/ Active Open Loop Heat Removal w/out Cubicle Filtration

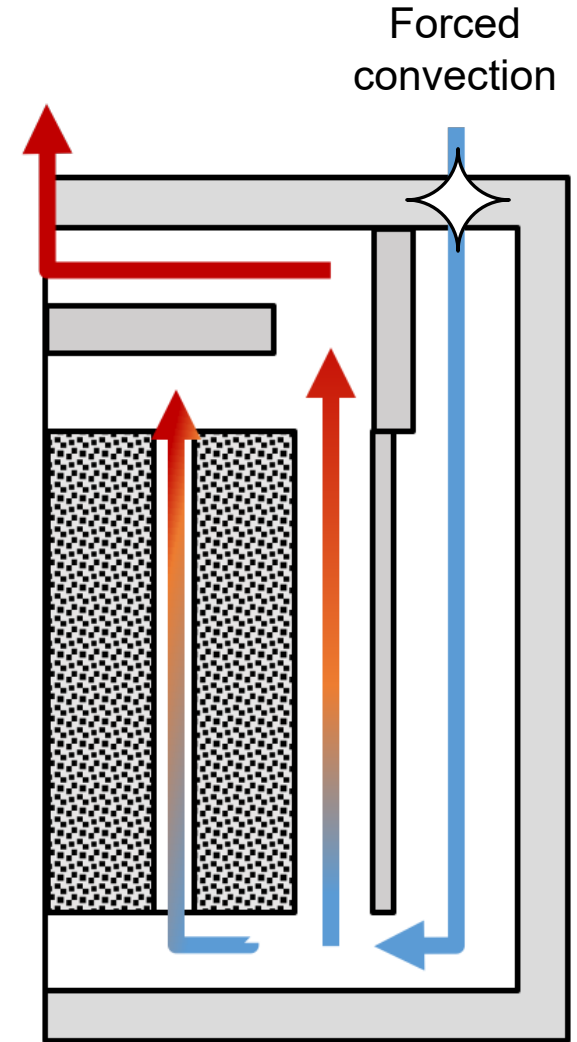
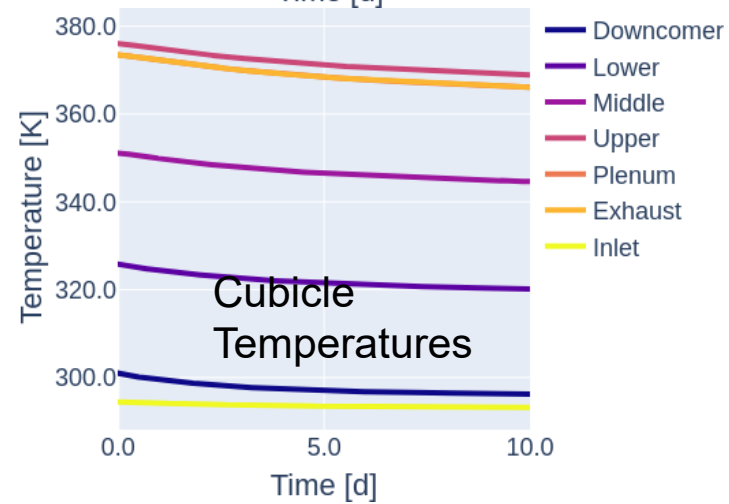
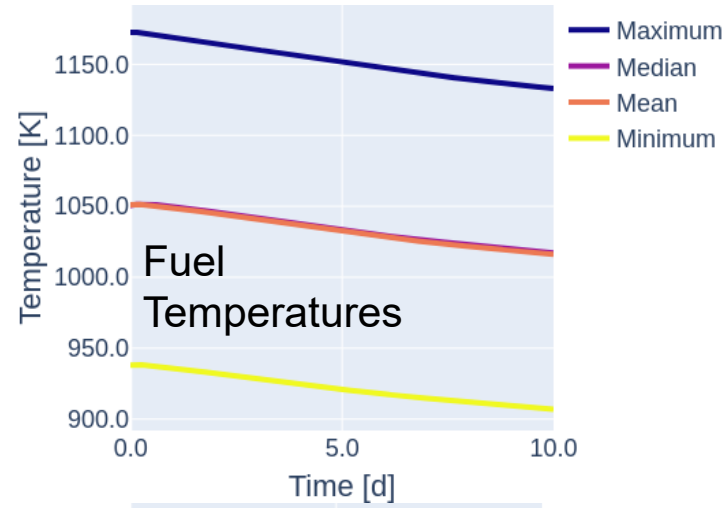
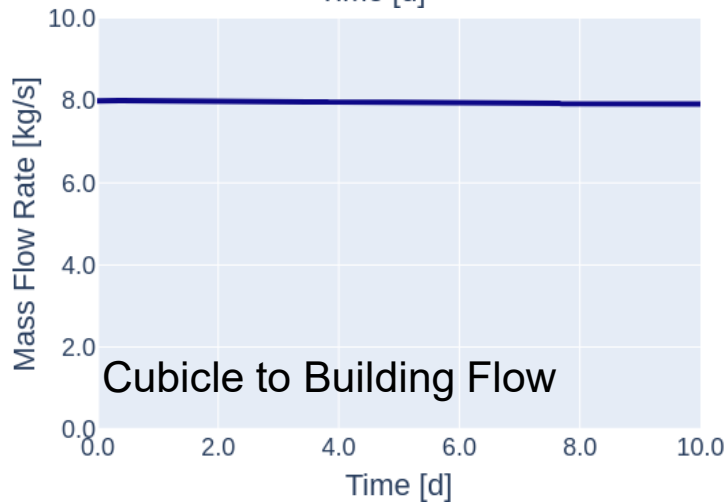
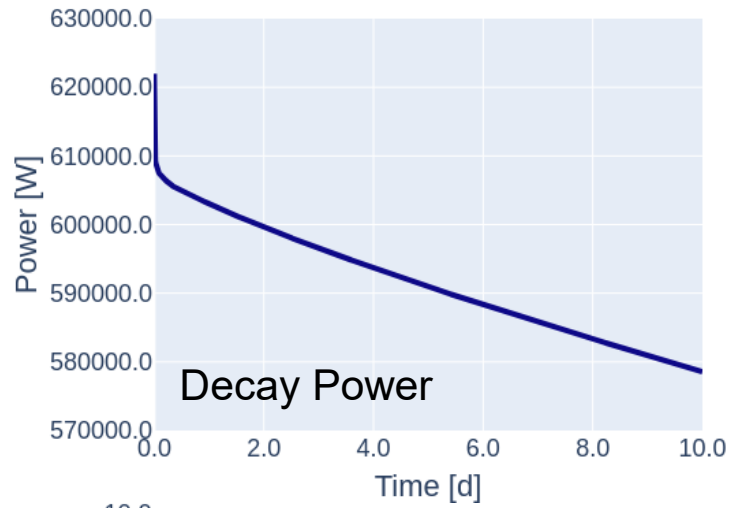

- Normal operations exhibit decreasing fuel and cubicle temperatures as short-lived isotopes decay
- Without filtration, a smaller fan (100.0 Pa ΔP) is needed to adequately cool the fuel and storage cubicle

Fuel Storage Tank – Used Fuel w/ Active Open Loop Heat Removal w/ Cubicle Filtration

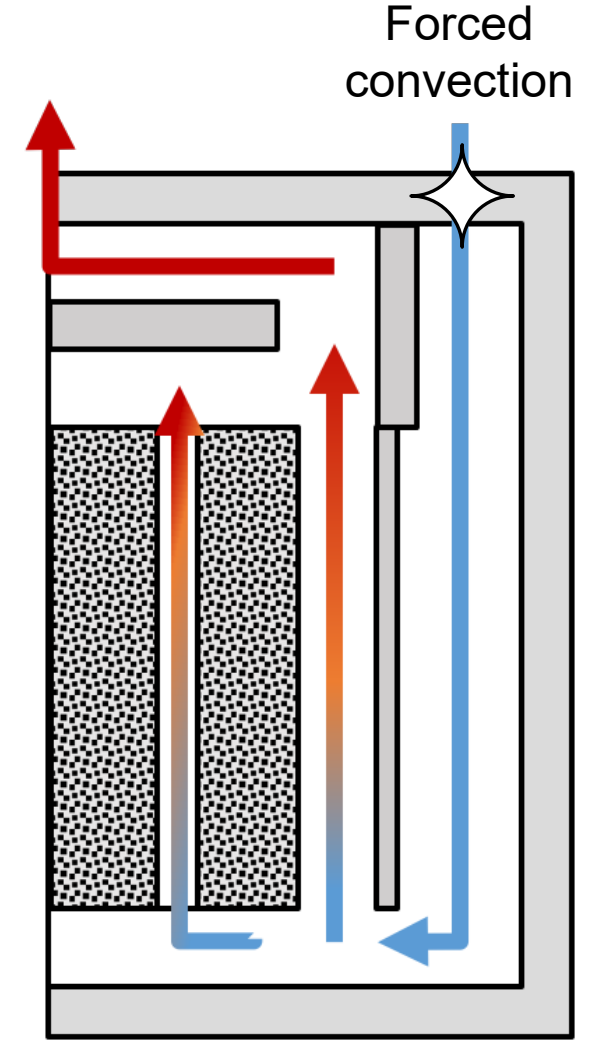
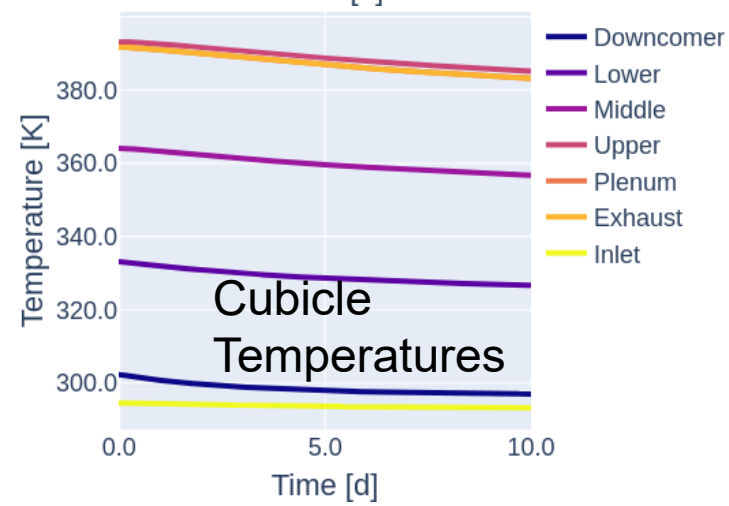
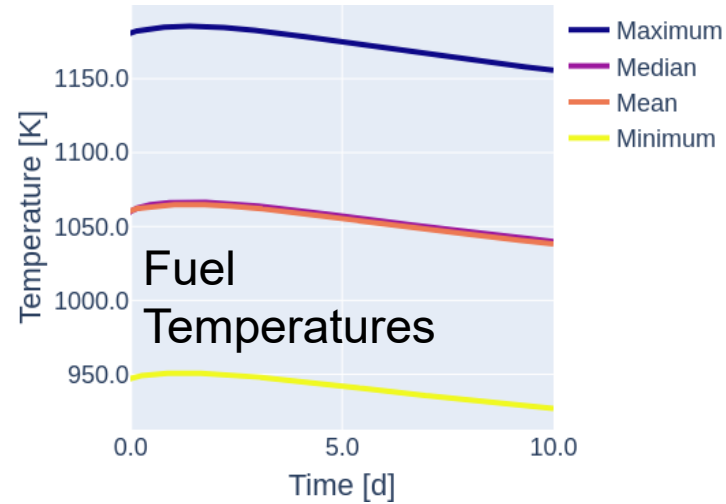
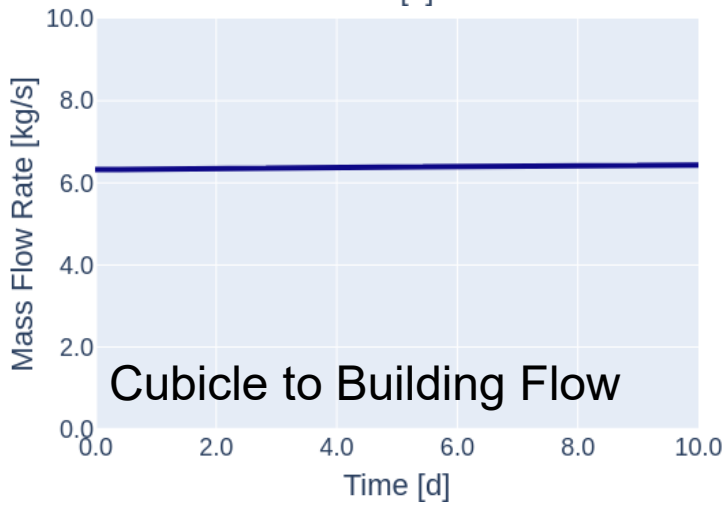
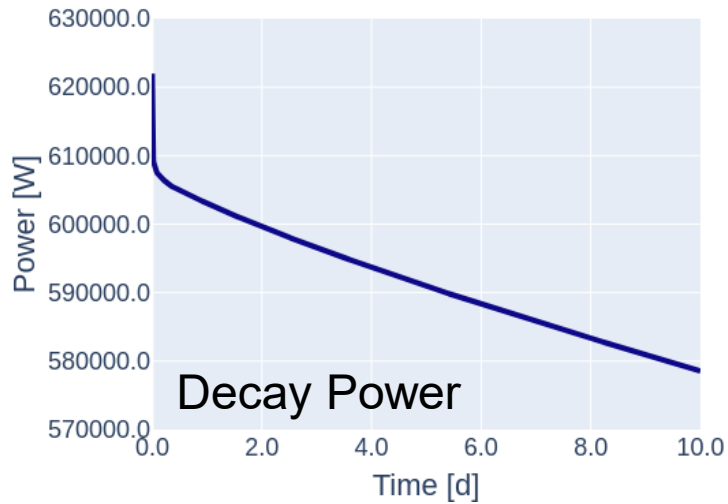

- Normal operations exhibit decreasing fuel and cubicle temperatures as short-lived isotopes decay
- With filtration, a larger fan (2000.0 Pa ΔP) is needed to adequately cool the fuel and storage cubicle

Fuel Storage Tank – Used Fuel w/ Spurious Loop Closure w/out Cubicle Filtration

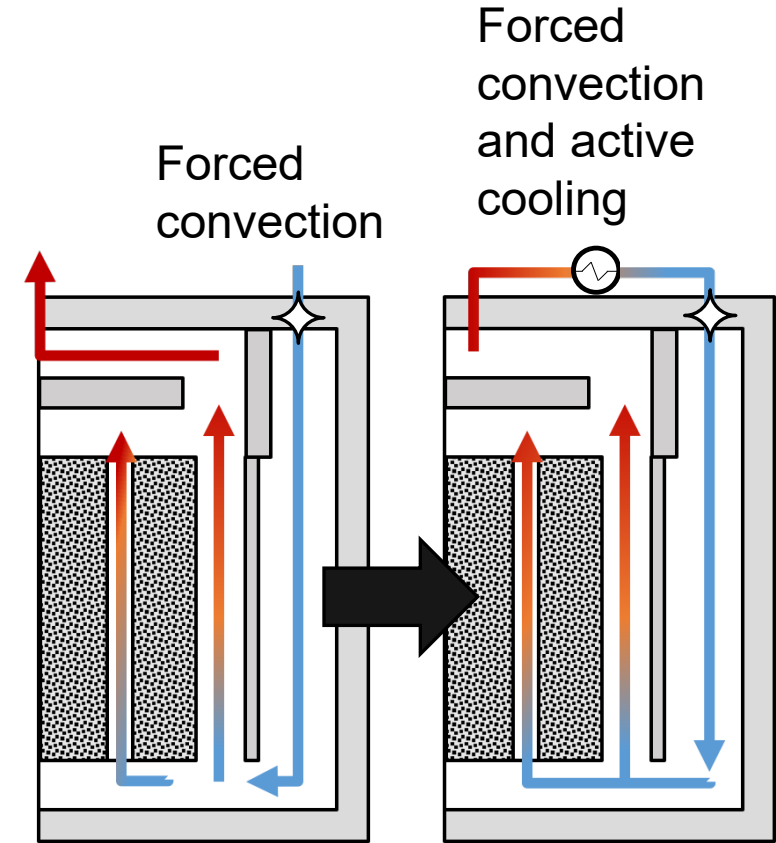
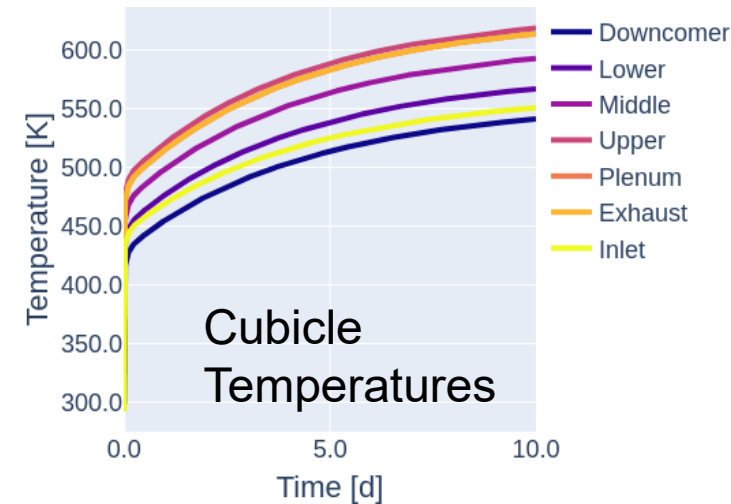
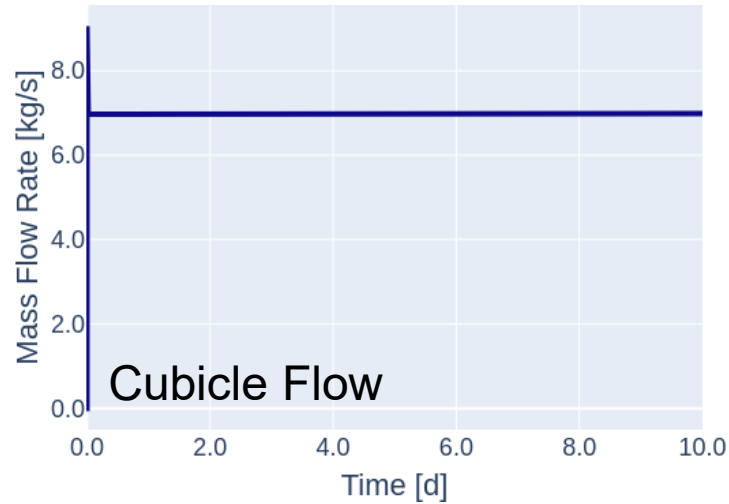
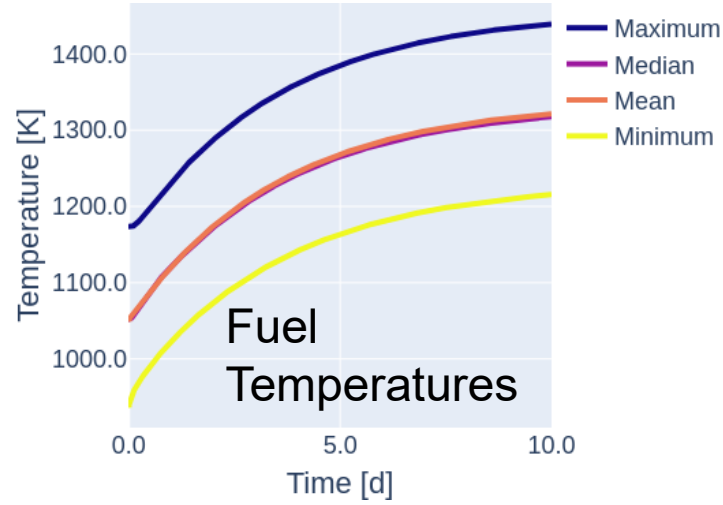
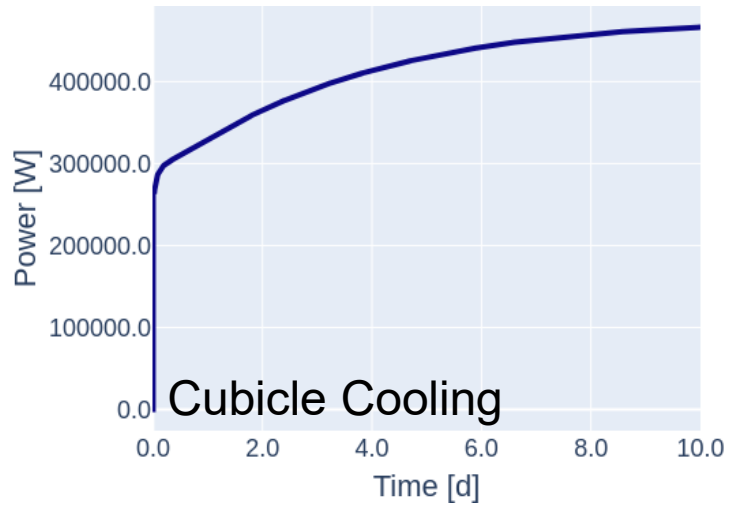

- When the cubicle does not have a filtration system, the smaller fan does not provide adequate cooling of the fuel and storage cubicle under a spurious loop closure

Fuel Storage Tank – Used Fuel w/ Spurious Loop Closure w/ Cubicle Filtration

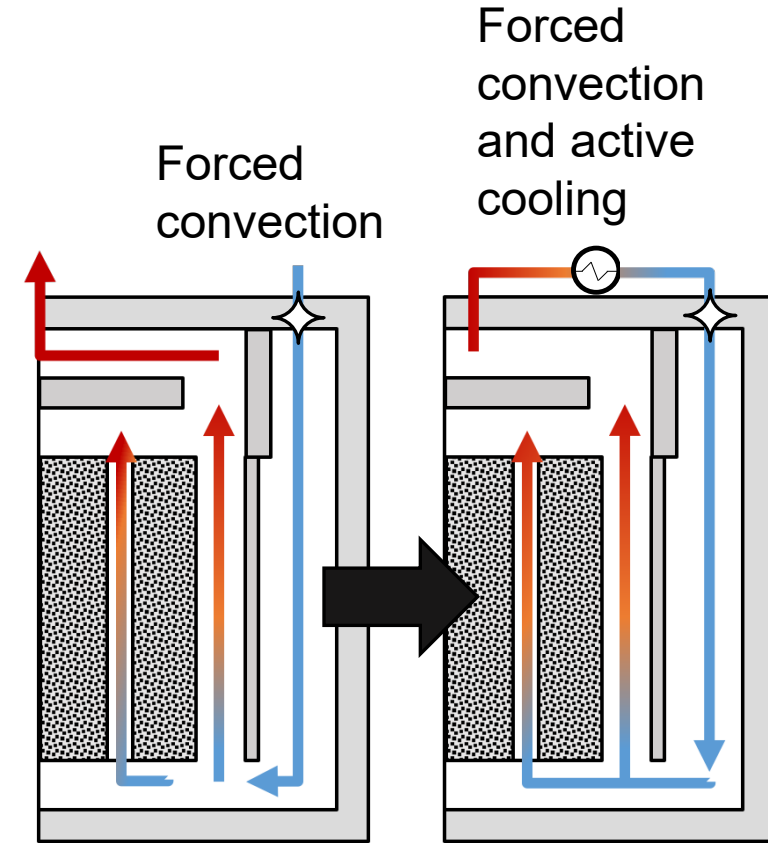
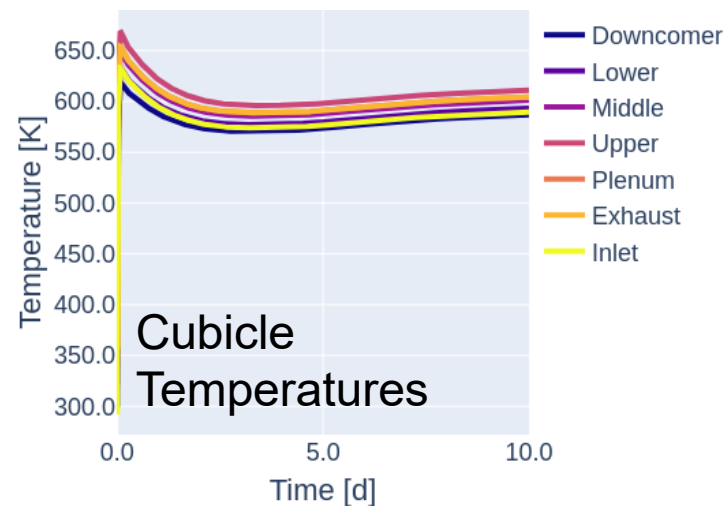
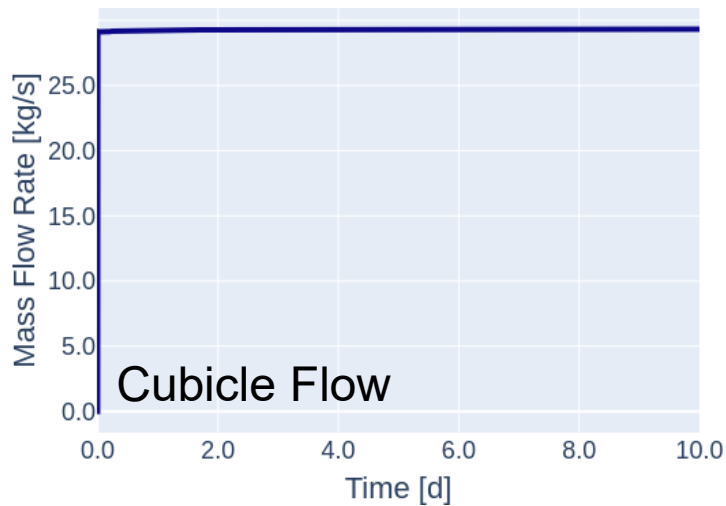
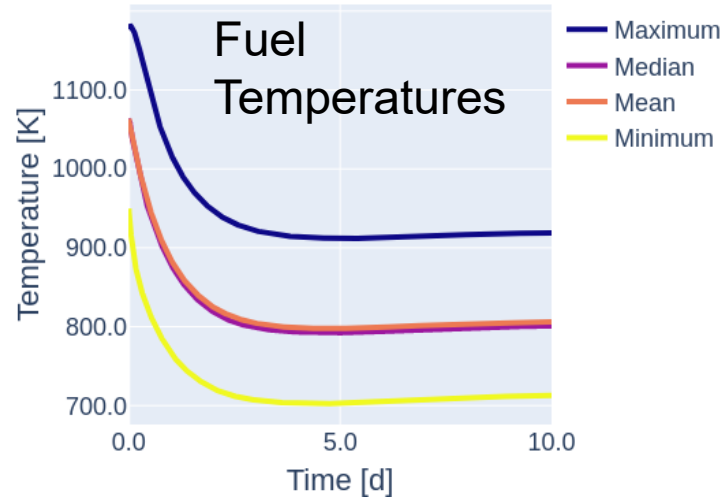
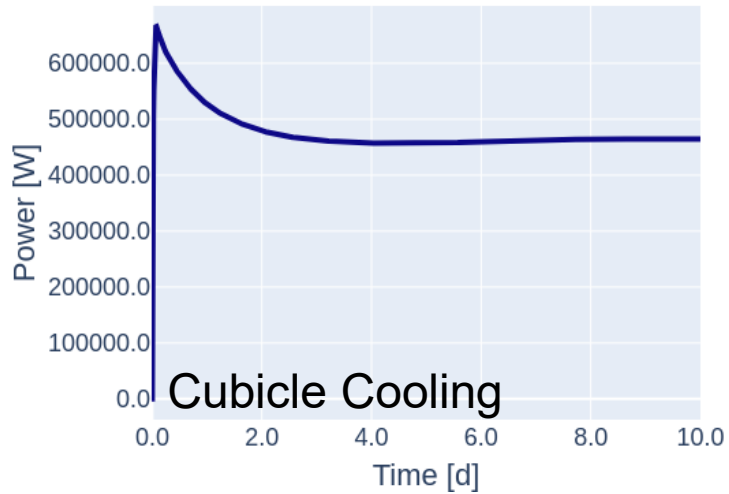

- When the cubicle does have a filtration system, the larger fan provides significant mass flow and adequate cooling of the fuel and storage cubicle under a spurious loop closure

Fuel Storage Tank – Used Fuel w/ Loss of Power w/out Cubicle Filtration

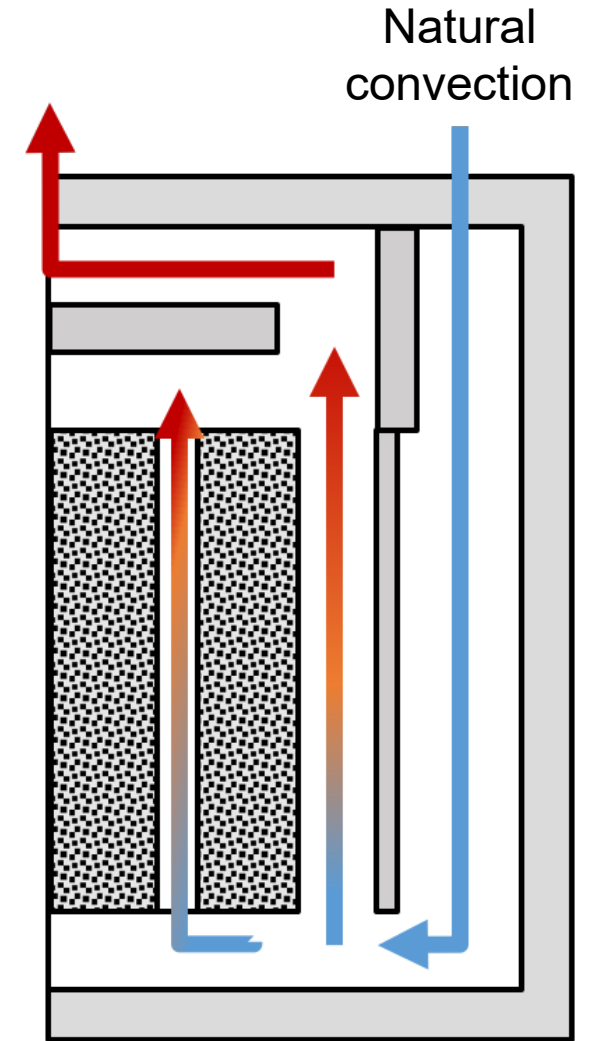
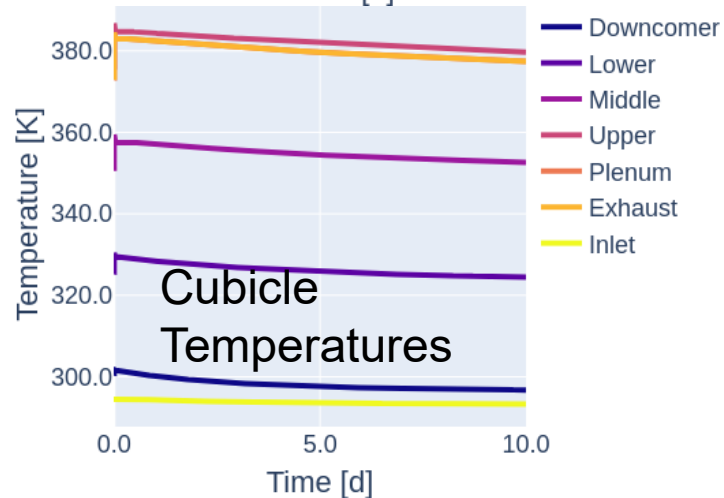
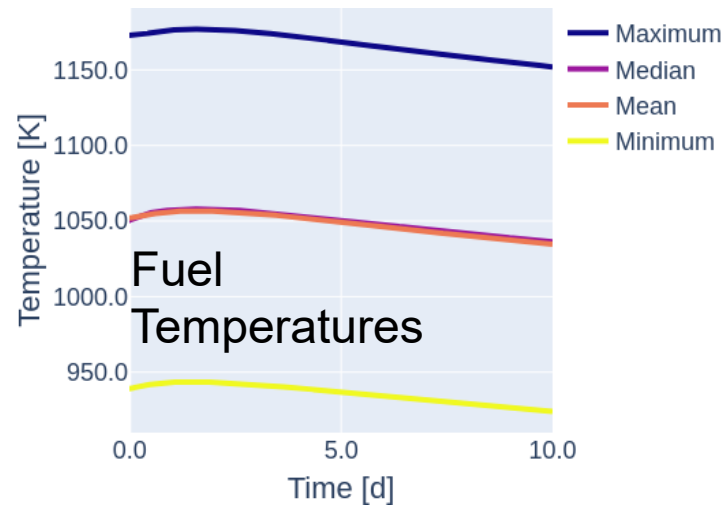
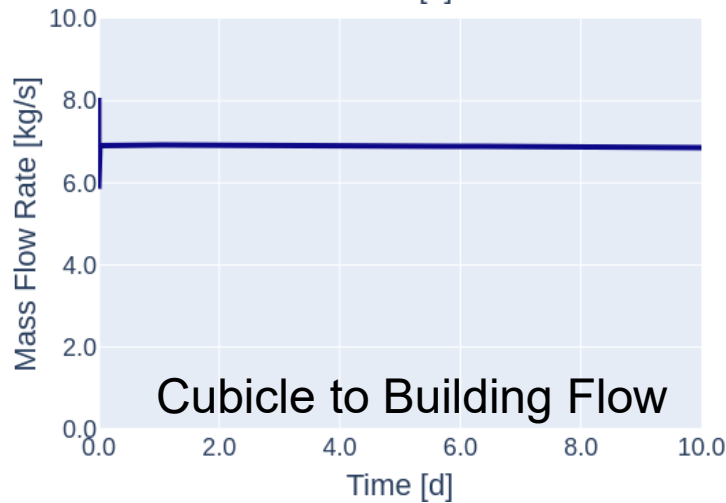
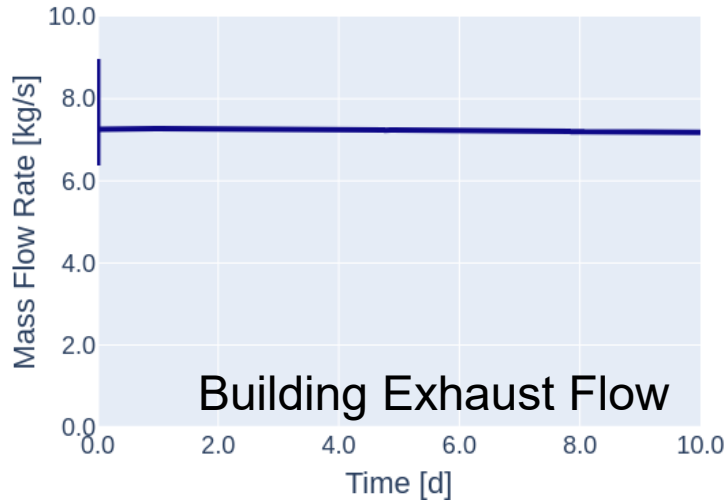

- The unobstructed path from the cubicle exhaust to the building exhaust (i.e., no cubicle filtration) facilitates production of a natural convection loop
- Maintains adequate cooling of the fuel and storage cubicle

Fuel Storage Tank – Used Fuel w/ Loss of Power w/ Cubicle Filtration

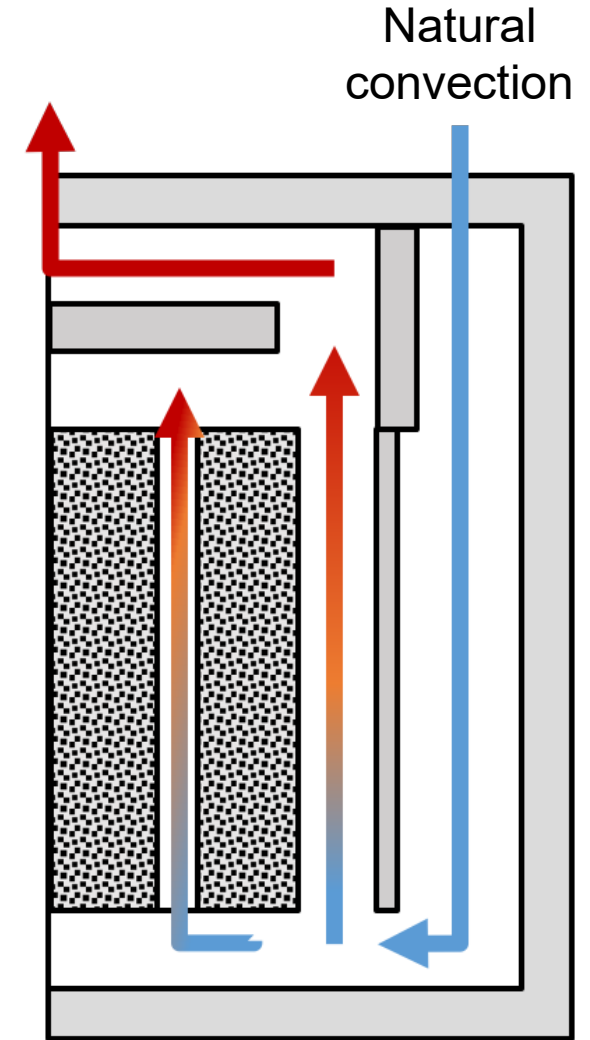
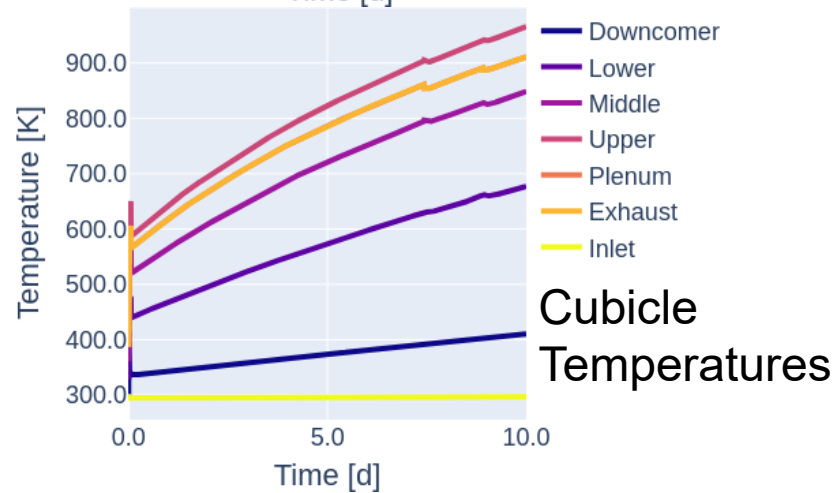
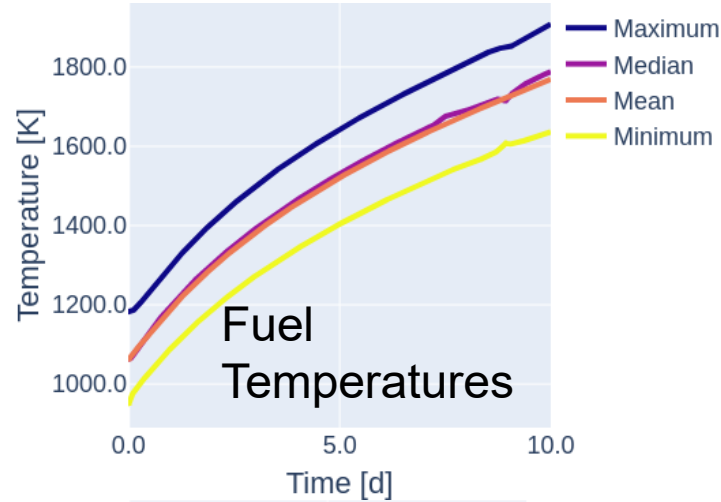
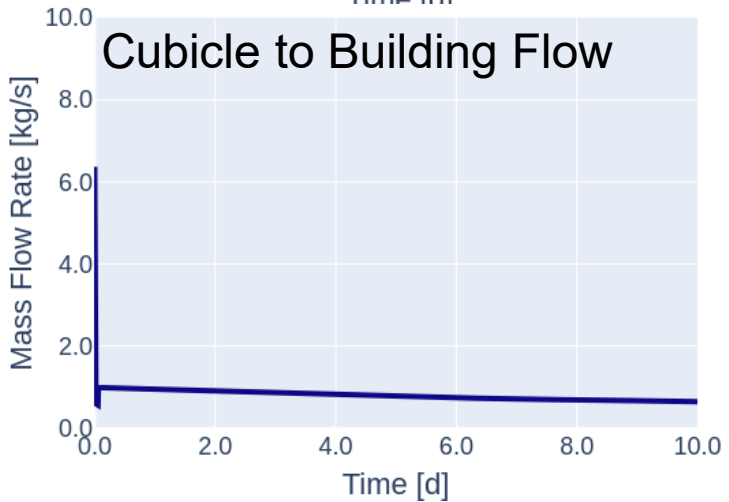
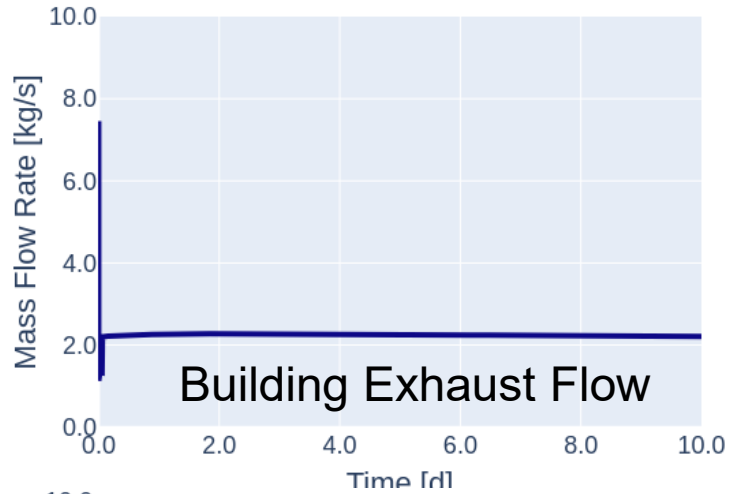

- The tortuous path of the cubicle filtration system obstructs production of a natural convection loop
- Cannot maintain adequate cooling of the fuel and storage cubicle

Spent Fuel Storage Tank

U4: Discharged Pebble Storage – Spent Fuel Storage Tank Transients

Scenario Summaries

- **Normal operations** – closed loop active cooling
- **Storage Tank and/or Cubicle Rupture** – rupture configurations that allow disruption of cubicle cooling and/or release of fission products
- **Loss of Forced Flow and/or Active Cooling** – Loss of cubicle cooling systems causing disruption of cubicle cooling
- **Loss of power** – transition from closed loop active cooling to open loop passive cooling resulting different airflow through the spent fuel cubicle
- **Loss of power with storage tank and cubicle rupture** – transition from closed loop active cooling to open loop passive cooling resulting different airflow through the spent fuel cubicle

Demonstration Characteristics and Important Phenomena

- Spent fuel radionuclide inventory development using SCALE
- Fuel modeling for non-reactor geometries
- Thermal Hydraulics
- Spent fuel Fuel storage tank operational modes and transients
- RN release and subsequent RN transport
- Graphite oxidation

Fuel Storage Tank – Spent Fuel w/ Active Closed Loop Heat Removal

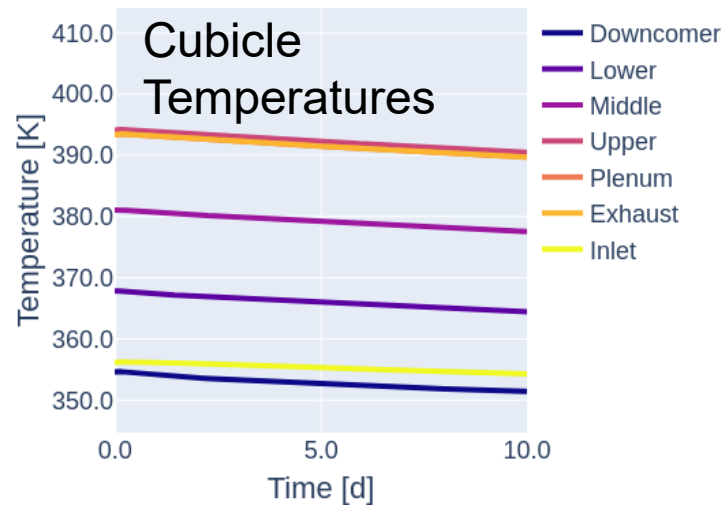
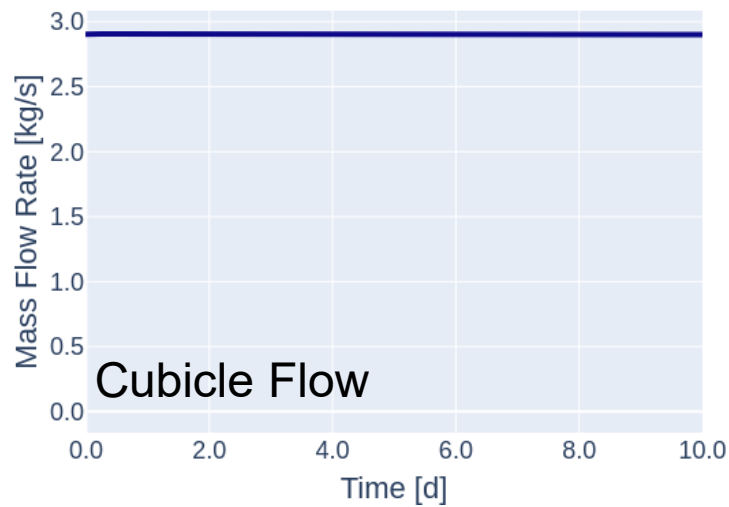
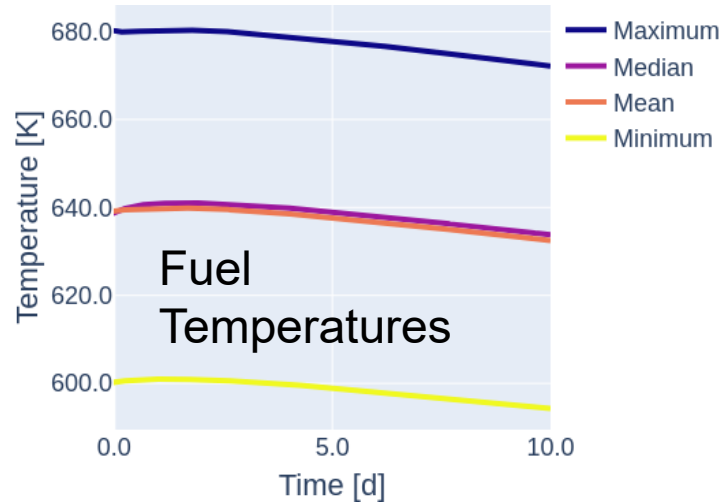
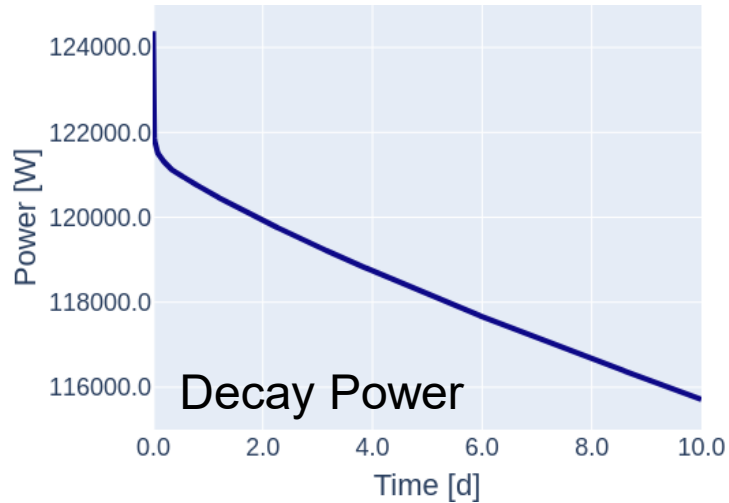

Forced convection and active cooling

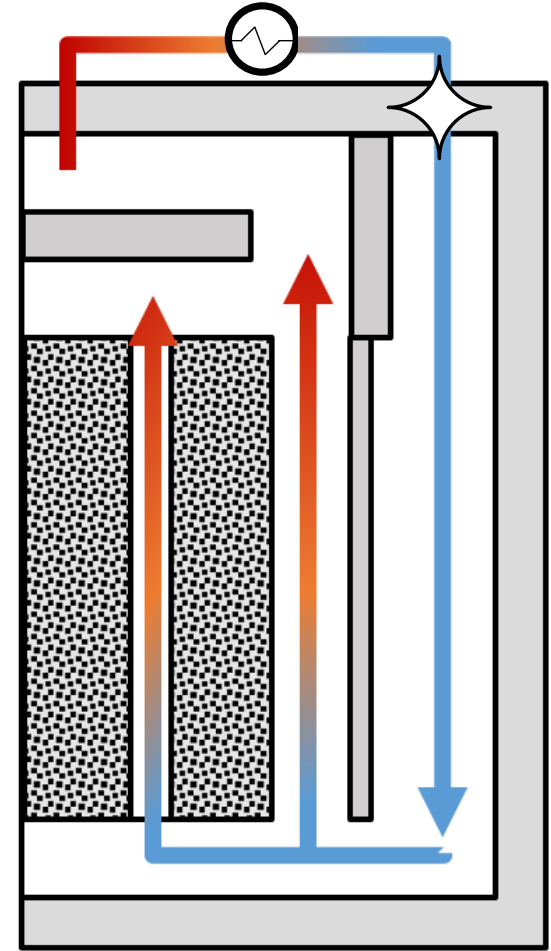

- Normal operations exhibit decreasing fuel and cubicle temperatures as short-lived isotopes decay
- Even with filtration, only a small fan (10.0 Pa ΔP) is needed to adequately cool the fuel and storage cubicle

Fuel Storage Tank – Spent Fuel w/ Active Closed Loop Heat Removal w/ Tank Rupture

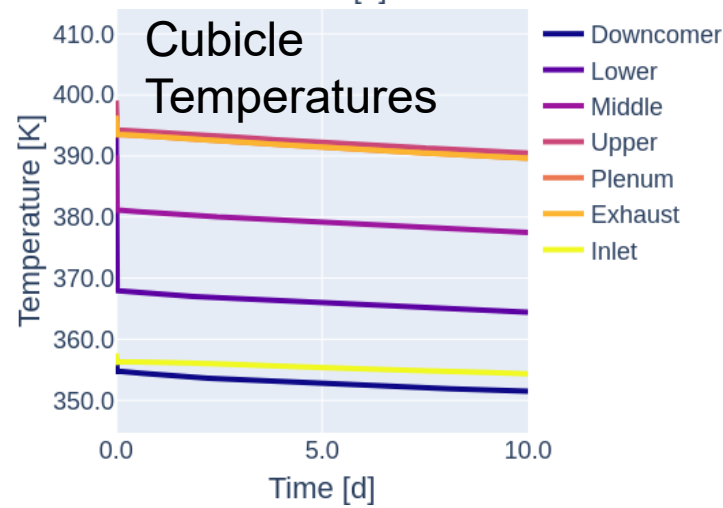
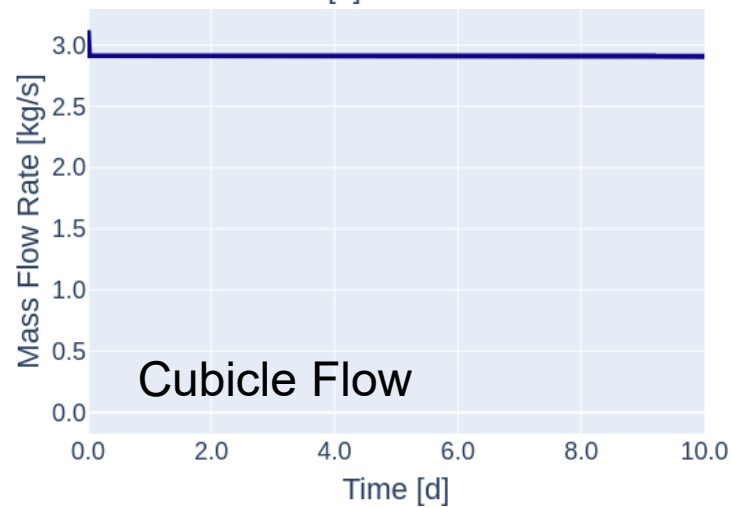
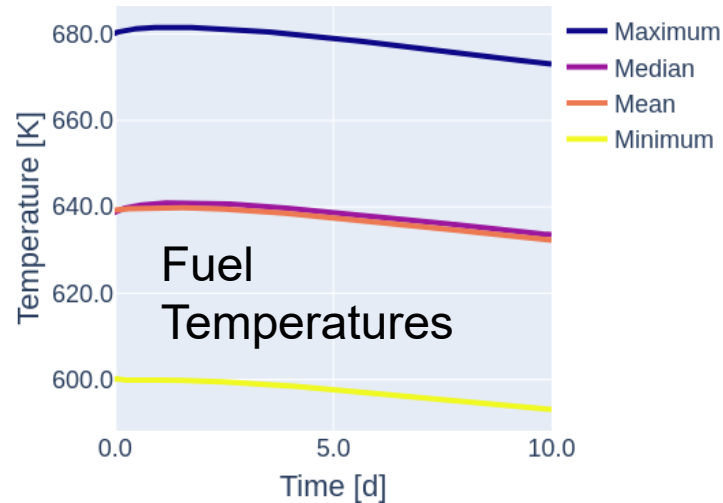
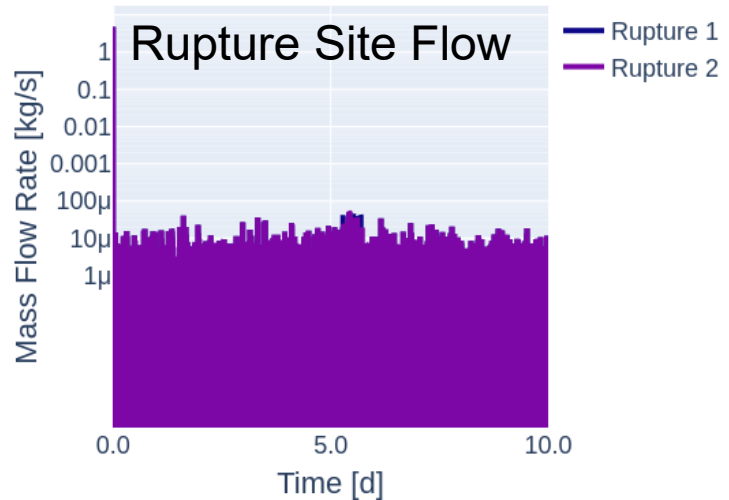

Forced convection and active cooling

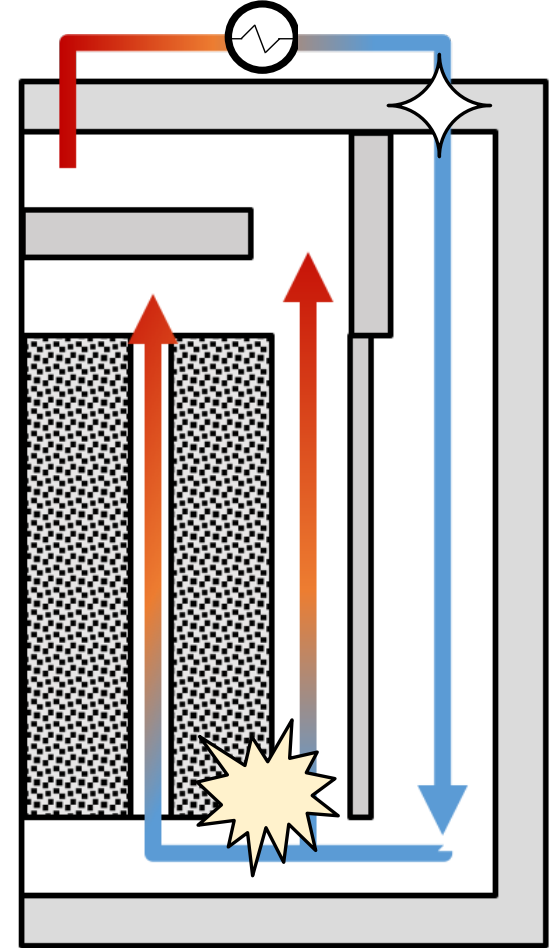

- Spent fuel storage tank is robust to a tank breach
- Adequate cooling of the fuel and storage cubicle is maintained

Fuel Storage Tank – Spent Fuel w/ Active Closed Loop Heat Removal w/ Cubicle Rupture

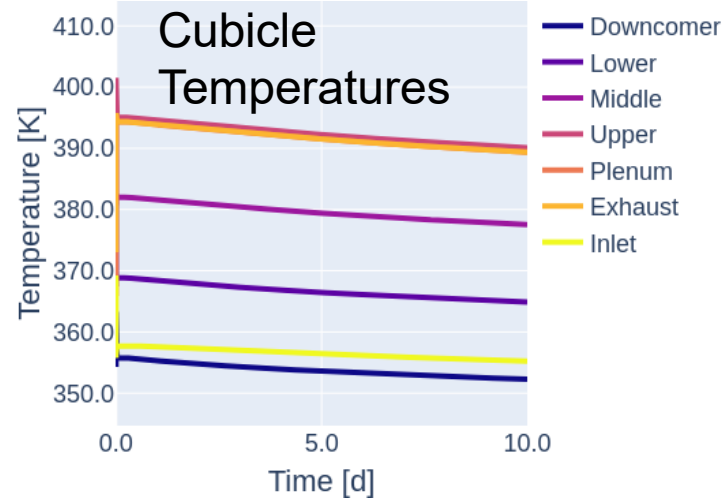
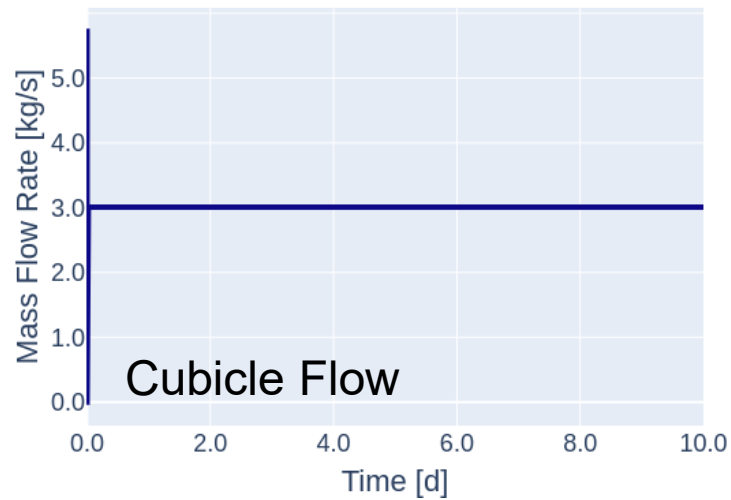
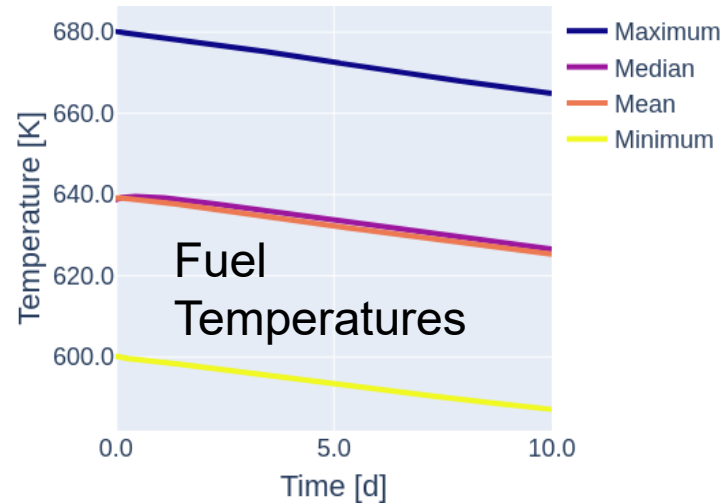
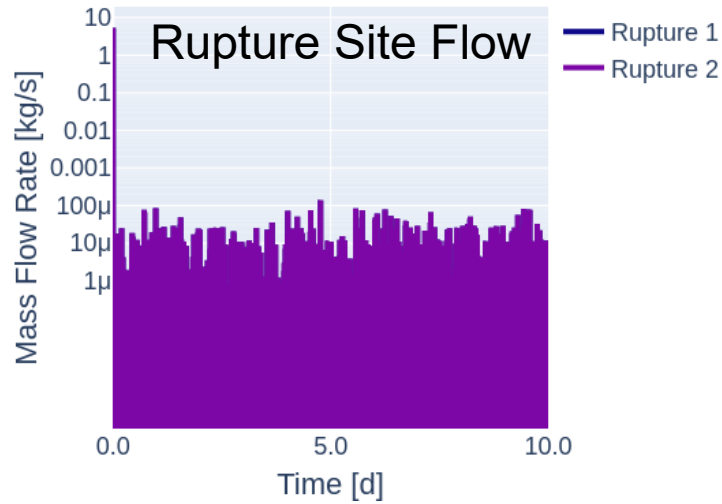

Forced convection and active cooling

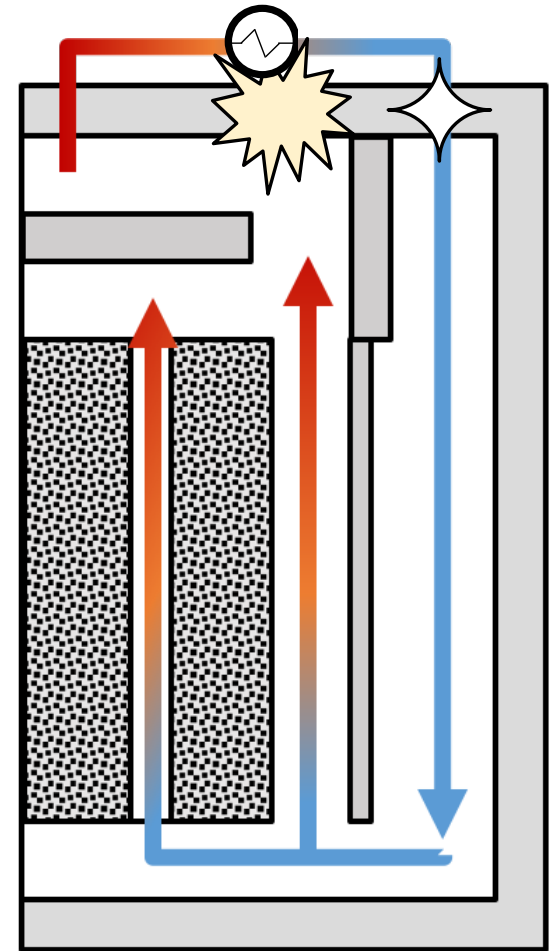

- Spent fuel storage tank is robust to a cubicle breach
- Forced convection maintains adequate cooling of the fuel and storage cubicle even with the rupture

Fuel Storage Tank – Spent Fuel w/ Active Closed Loop Heat Removal w/ Tank and Cubicle Rupture

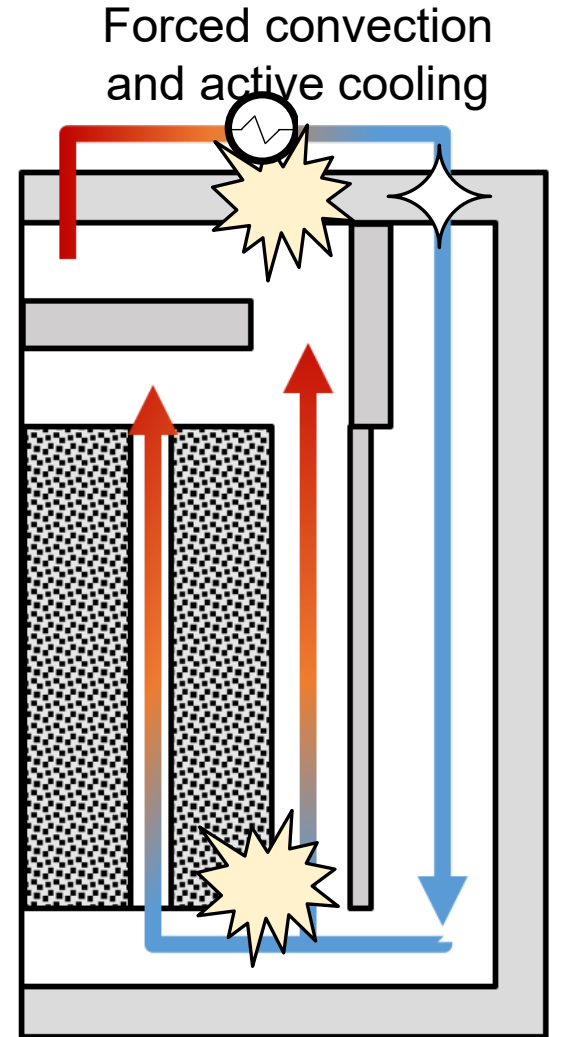
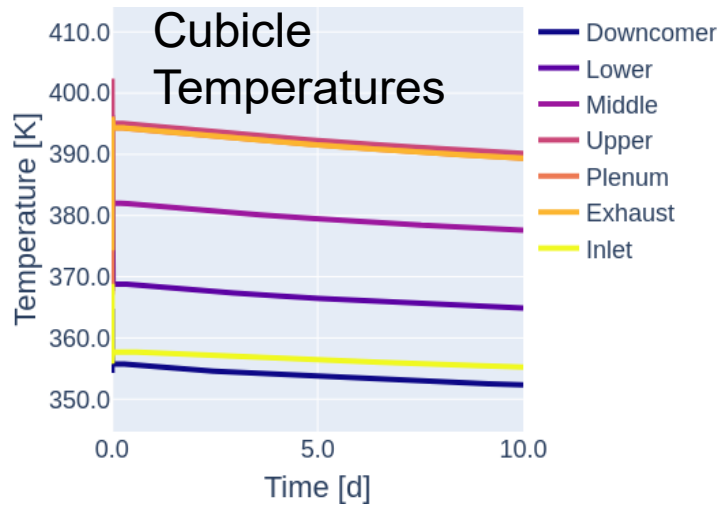
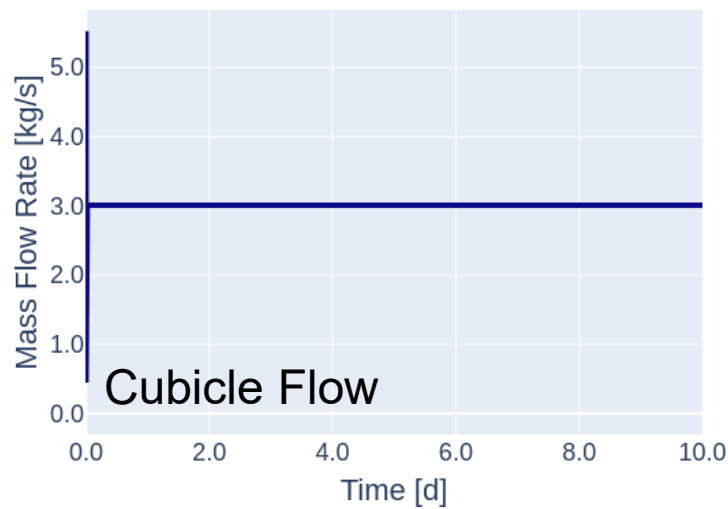
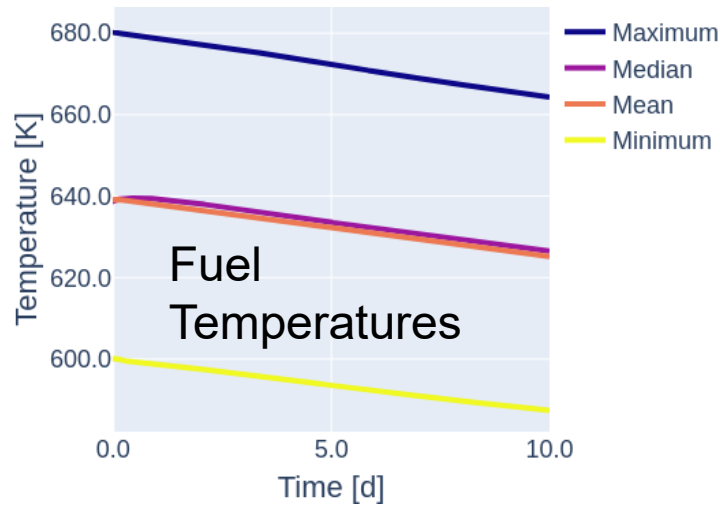
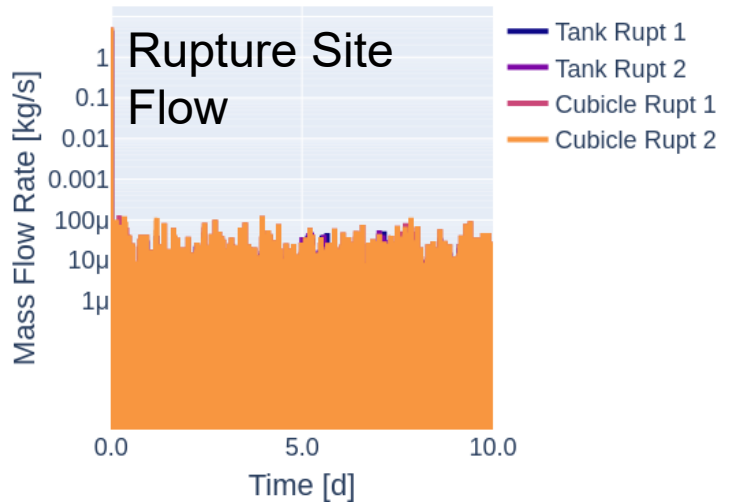

- Spent fuel storage tank is robust to a combined tank and cubicle breach.
- Forced convection maintains adequate cooling of the fuel and storage cubicle even with the ruptures

Fuel Storage Tank – Spent Fuel w/ Active Closed Loop Heat Removal w/ Fan Failure

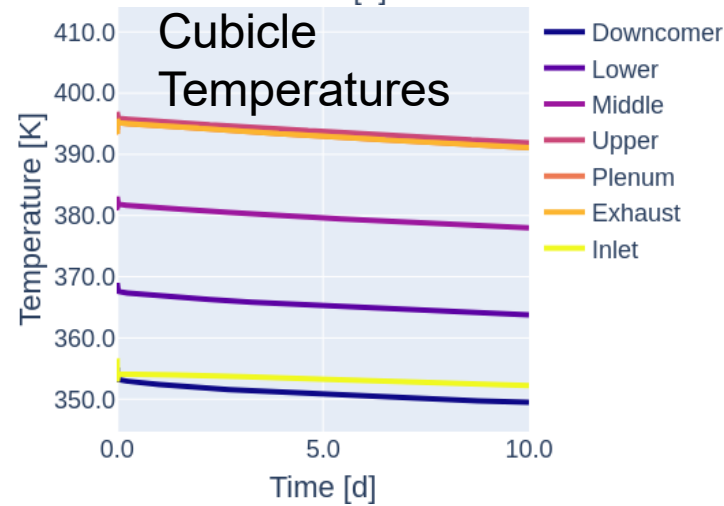
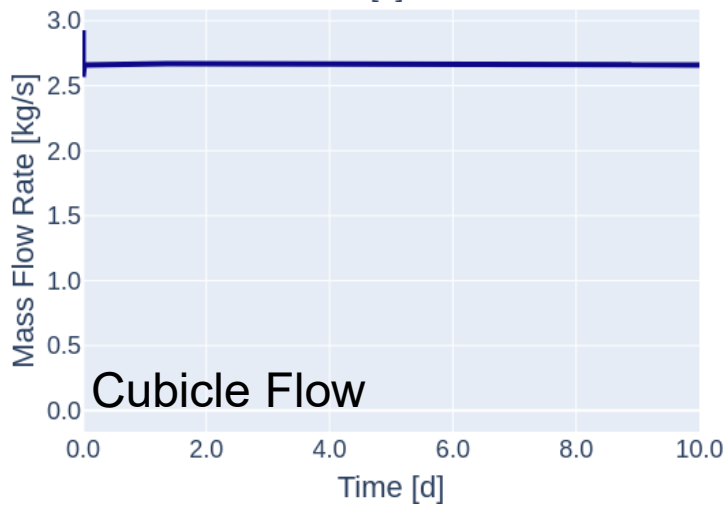
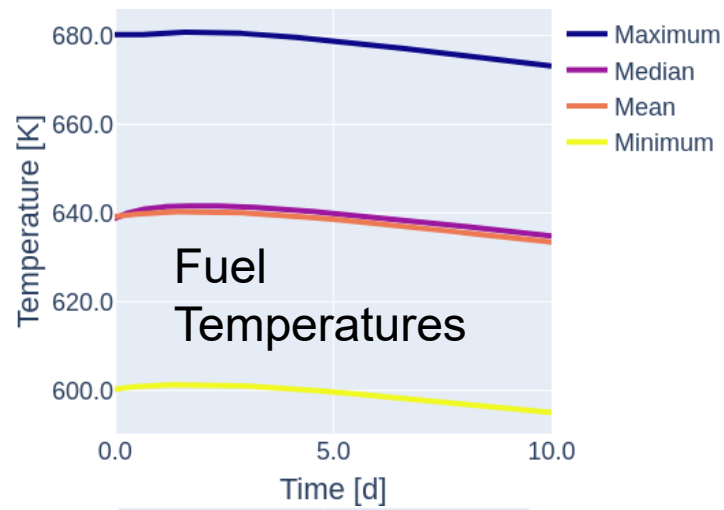
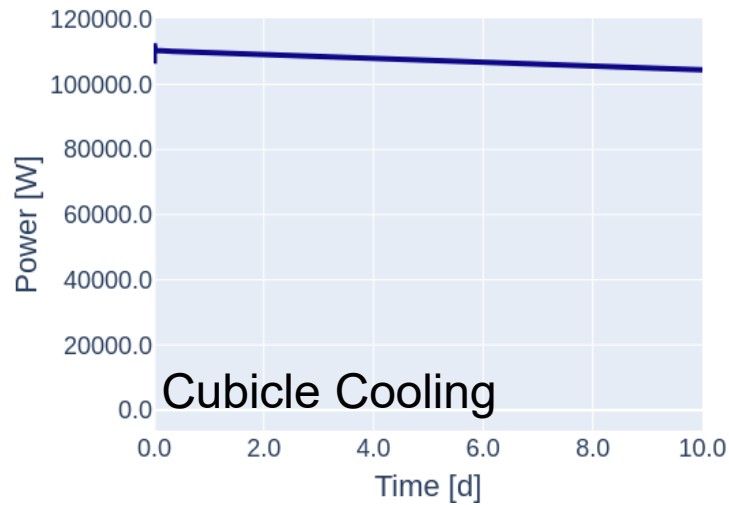

Natural convection and active cooling

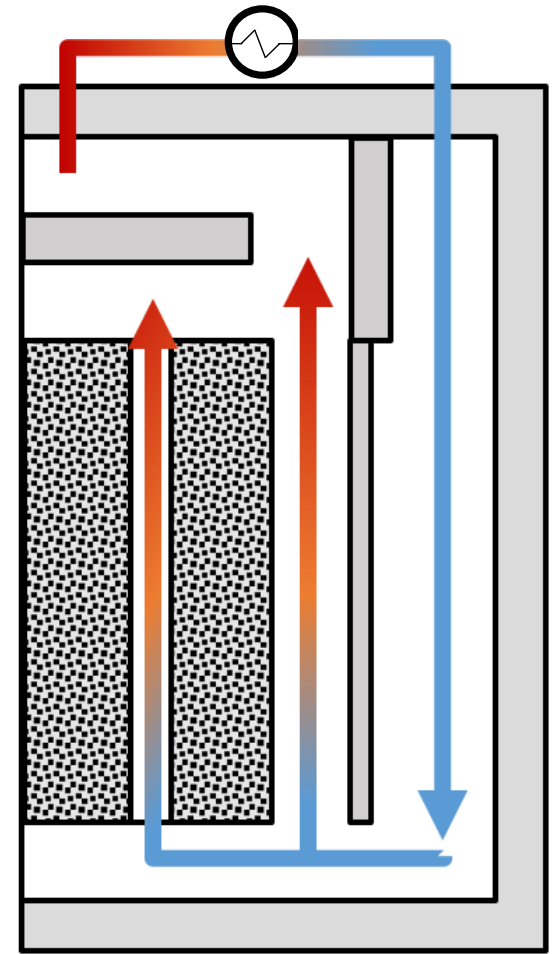

- Spent fuel storage tank is robust to loss of forced convection
- Natural convection is established and maintains adequate cooling of the fuel and storage cubicle

Fuel Storage Tank – Spent Fuel w/ Active Closed Loop Heat Removal w/ Heat Exchanger Failure

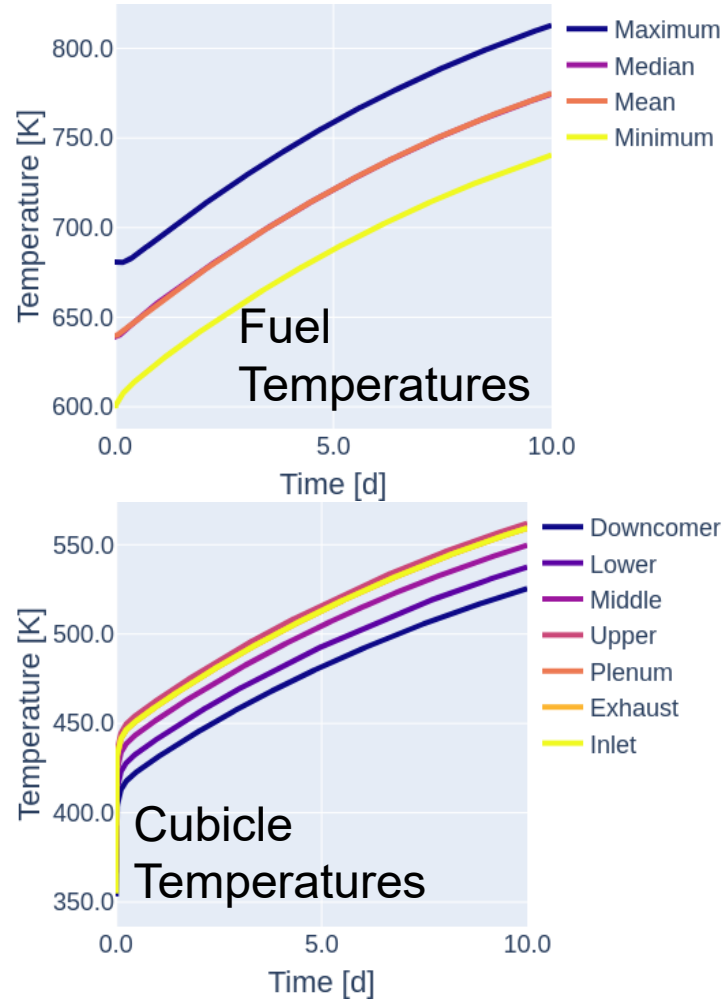
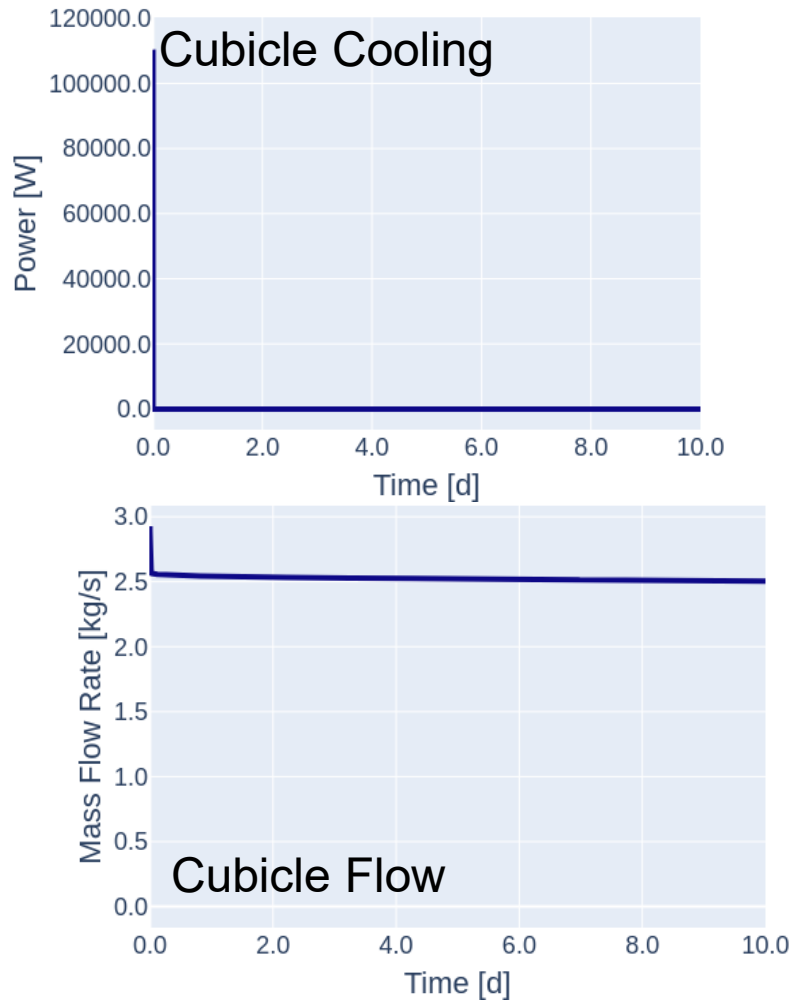

Forced convection without heat removal

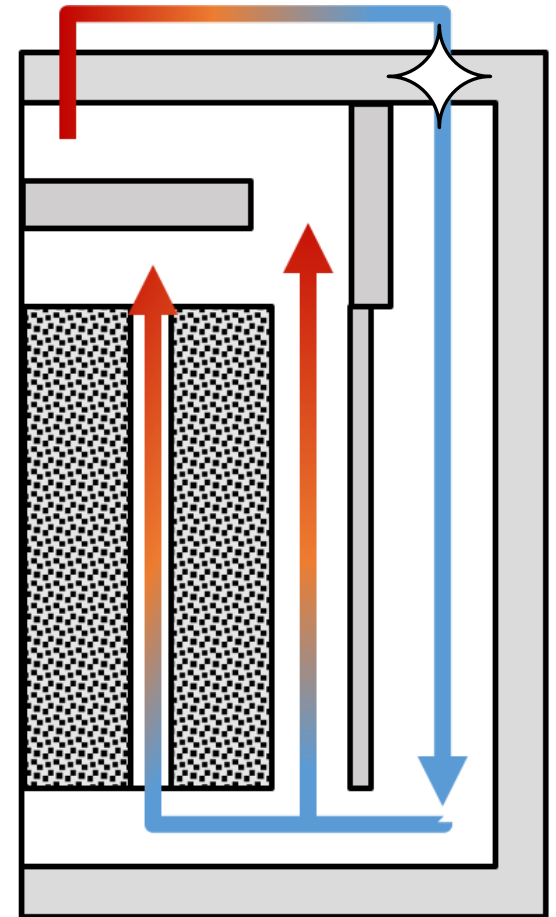

- Spent fuel storage tank is challenged by loss of active cooling
- Without active cooling, the fuel and cubicle atmosphere heats up

Fuel Storage Tank – Spent Fuel w/ Active Closed Loop Heat Removal w/ Fan and Heat Exchanger Failure

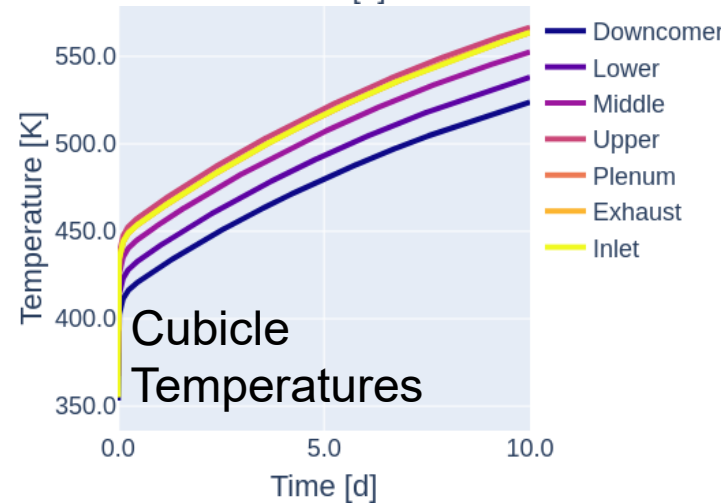
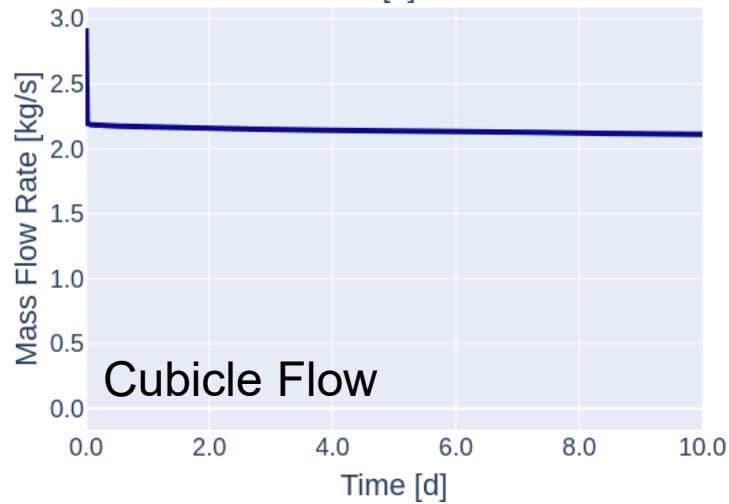
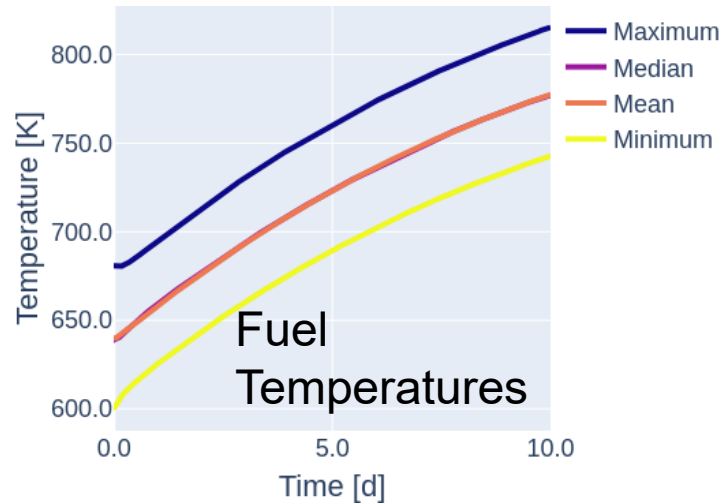
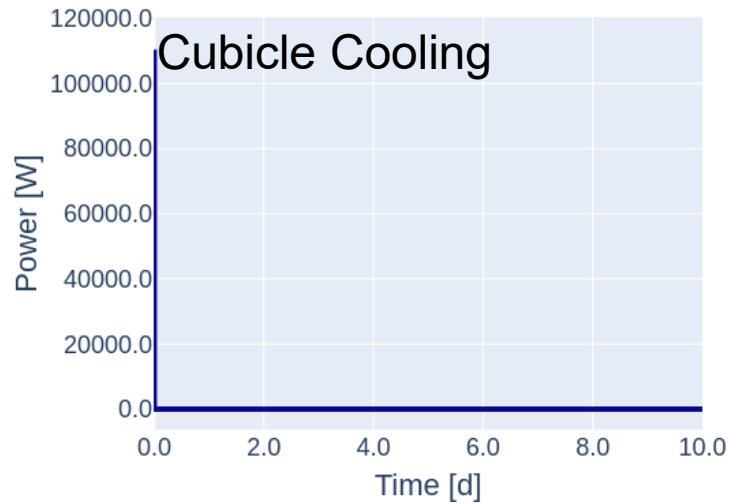

Natural convection without heat removal

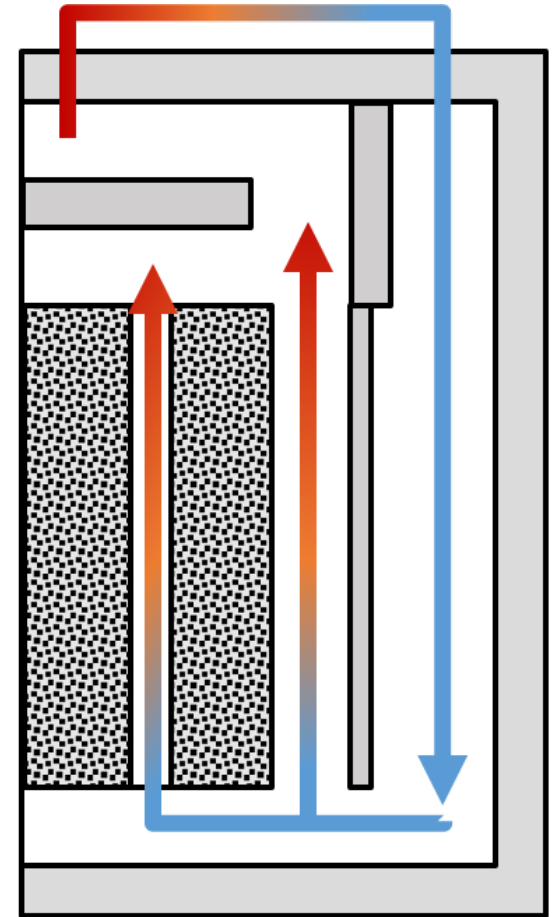

- Spent fuel storage tank is challenged by combined loss of forced convection and active cooling
- Without active cooling, the fuel and cubicle heat up in similar form to isolated loss of active cooling

Fuel Storage Tank – Spent Fuel w/ Active Closed Loop Heat Removal w/ Loss of Power

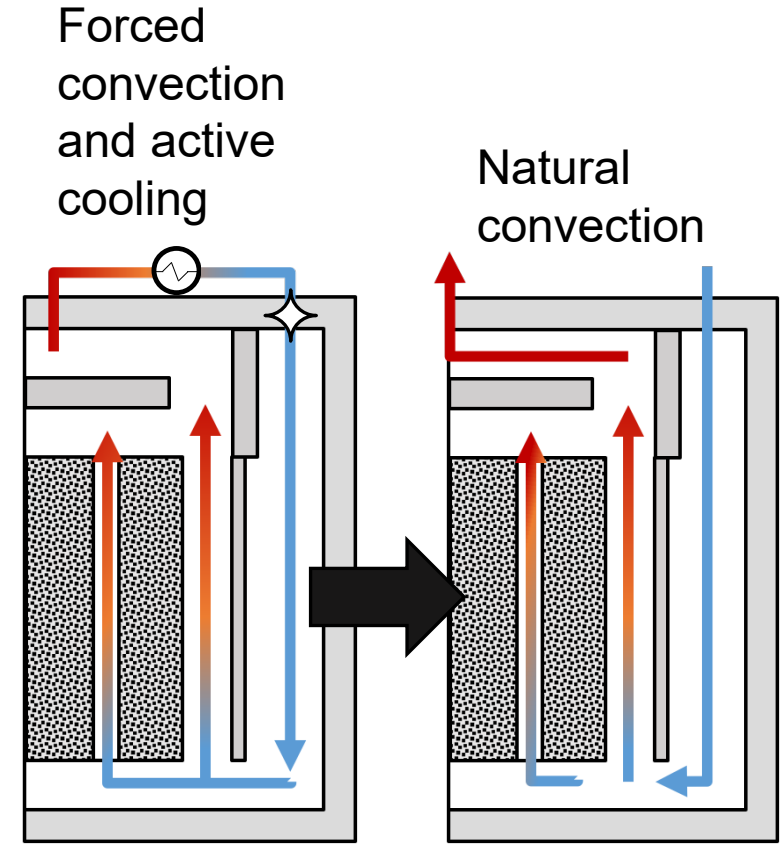
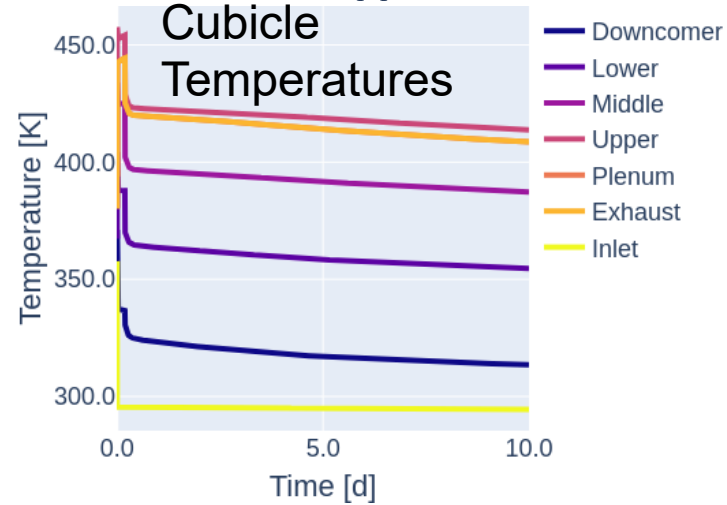
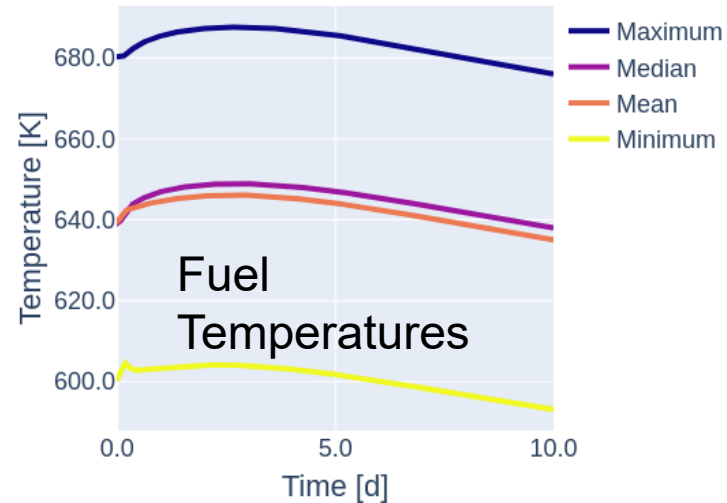
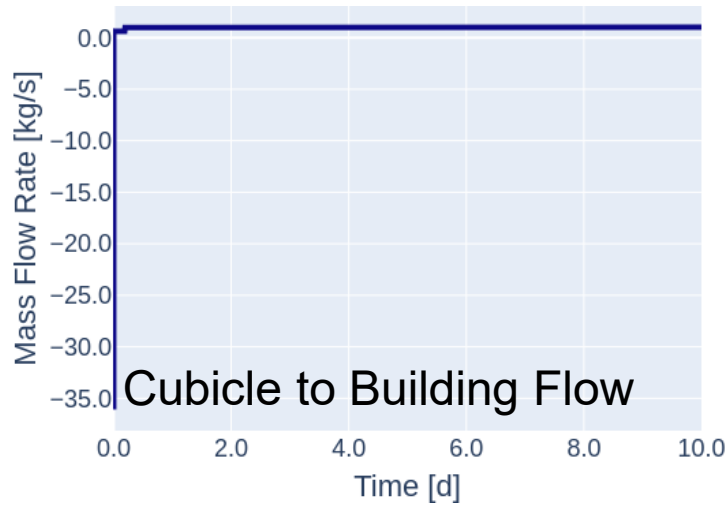
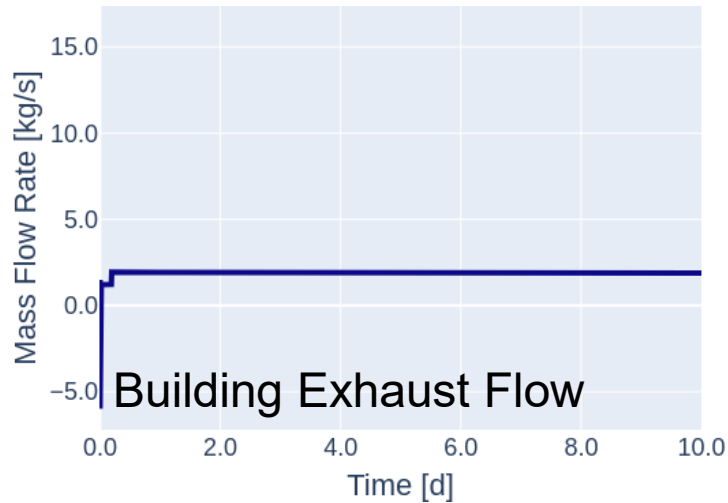

- Spent fuel storage tank is robust to loss of power
- Natural convection (sourced from the environment) is established and maintains adequate cooling of the fuel and storage cubicle

Fuel Storage Tank – Spent Fuel w/ Active Closed Loop Heat Removal w/ Loss of Power w/ Tank+Cubicle Breach

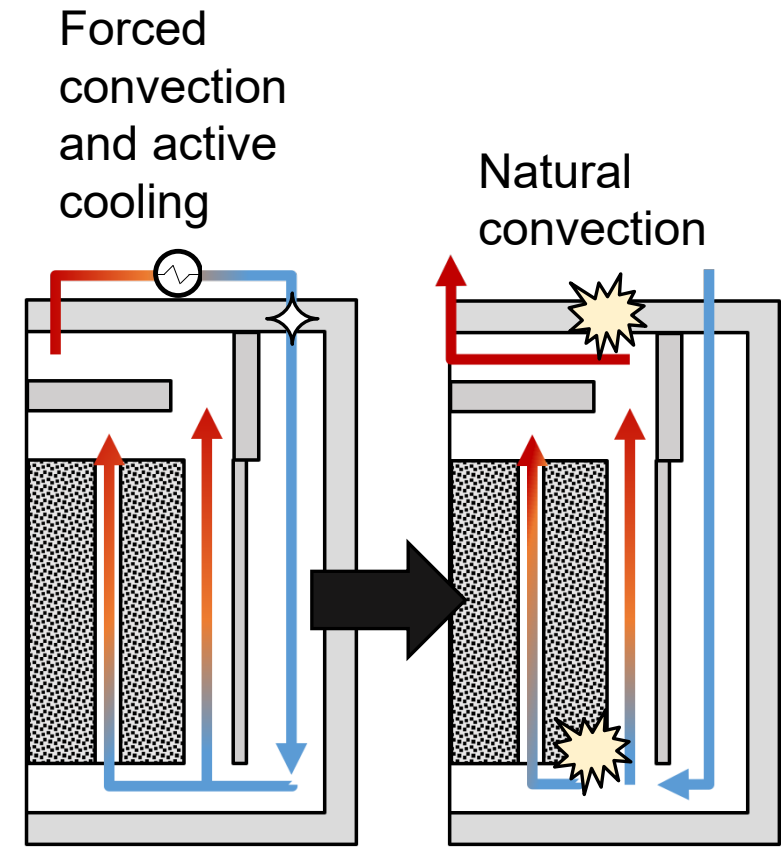
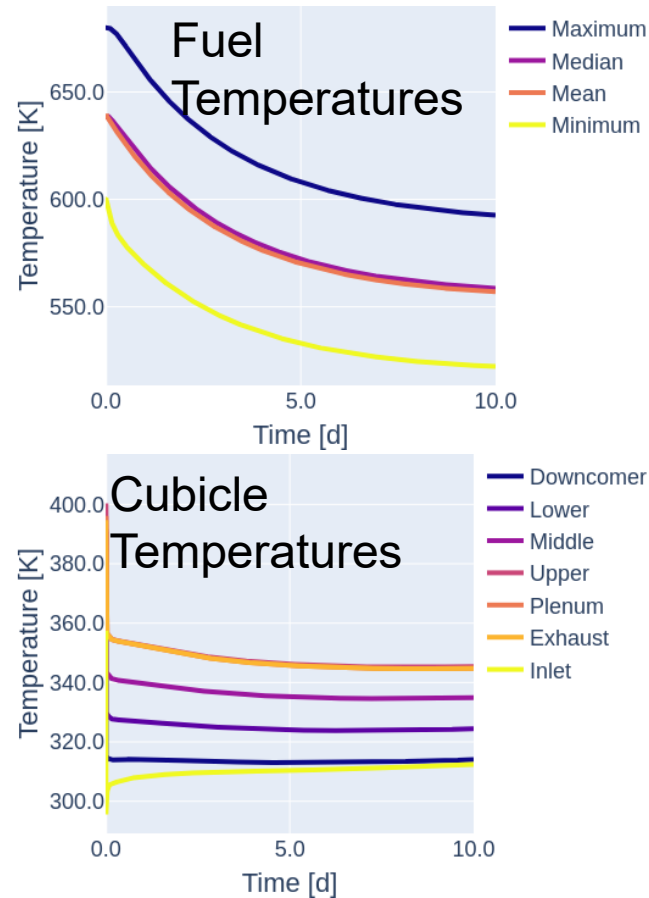
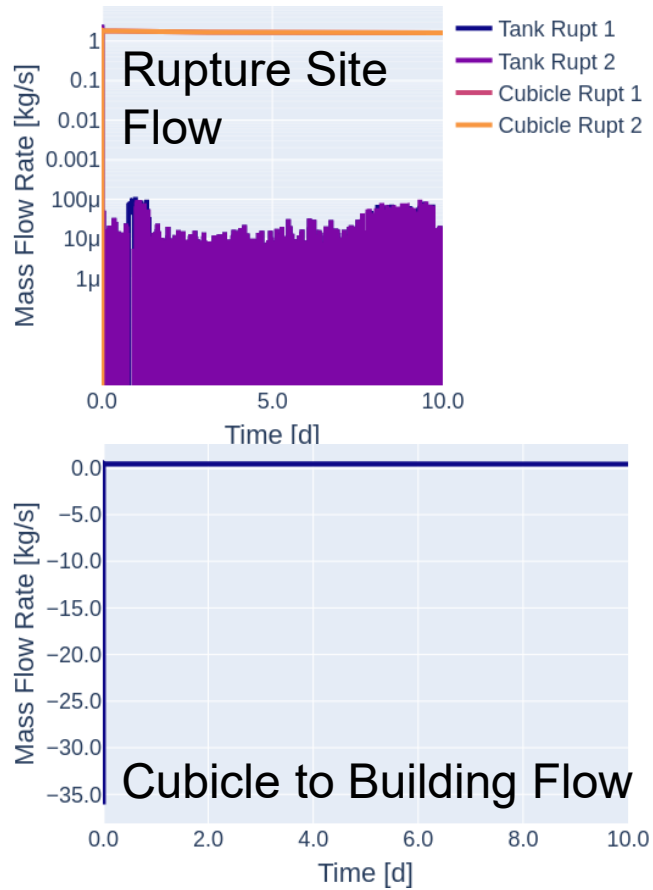

- Spent fuel storage tank is robust to loss of power coincident with combined tank and cubicle rupture
- Natural convection (sourced from the environment) is established and maintains adequate cooling of the fuel and storage cubicle
- Flow through the cubicle rupture heats building volumes

Spent Fuel Storage Tank Sensitivities

Spent Fuel Storage Sensitivity Specification

Model	Parameter	Distribution	Range
TRISO Model Parameters	Fuel Pebble Emissivity (-)	Uniform	0.5 – 0.999
	Fuel Pebble Bed Porosity (-)	Uniform	0.3 – 0.5
Design Parameters	Graphite Conductivity Multiplier (-)	Uniform	0.5 – 1.5
	Decay Heat Multiplier (-)	Uniform	1.0 – 10.0
	Cubicle Flow Area Multiplier (-)	Log-Uniform	0.01 – 1.0
	Cubicle Filter System	Discrete	True/False
	Cubicle Fan ΔP	Uniform	1.0 – 3000.0
Scenario Parameters	Tank Rupture Area Multiplier (-)	Uniform	0.1 – 1.0
	Cubicle Rupture Area Multiplier (-)	Uniform	0.1 – 1.0

Quantity of Interest Horsetails

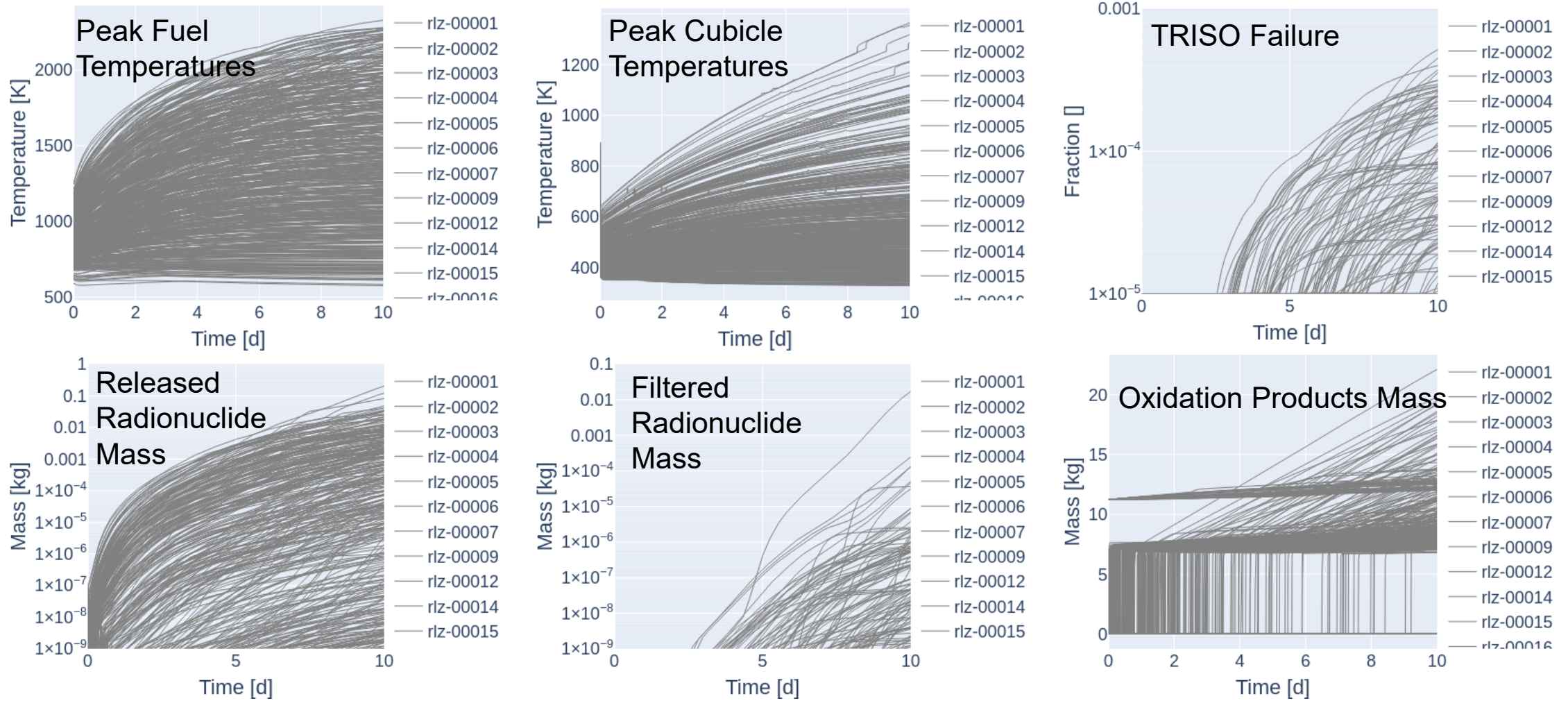

- Fuel Temperature drives TRISO failure and radionuclide diffusion out of TRISO
- Quantities of interest represent a large spectrum of outcomes

Model Sensitivities to Peak Quantities of Interest

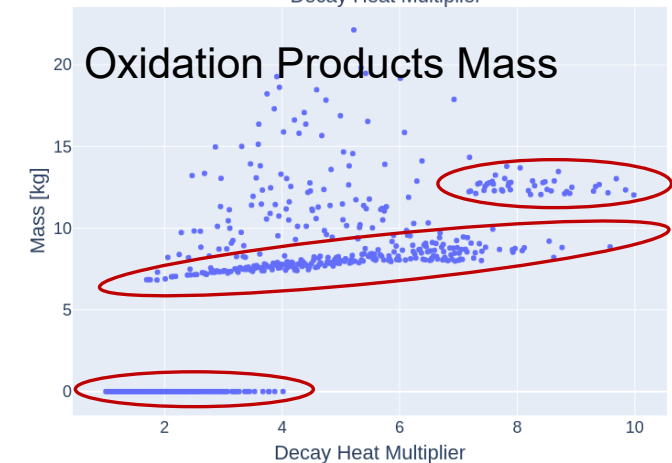
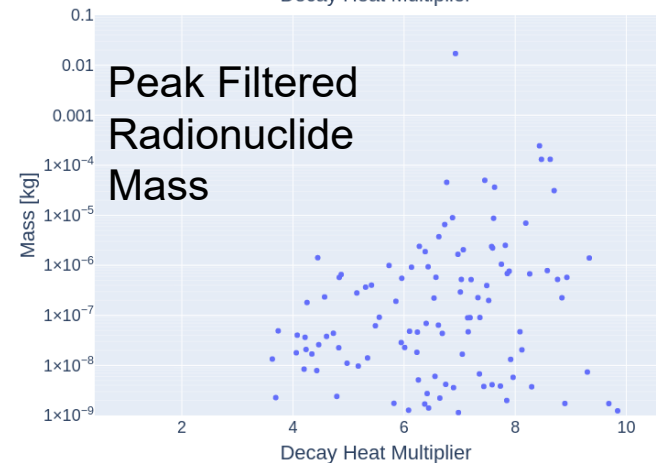
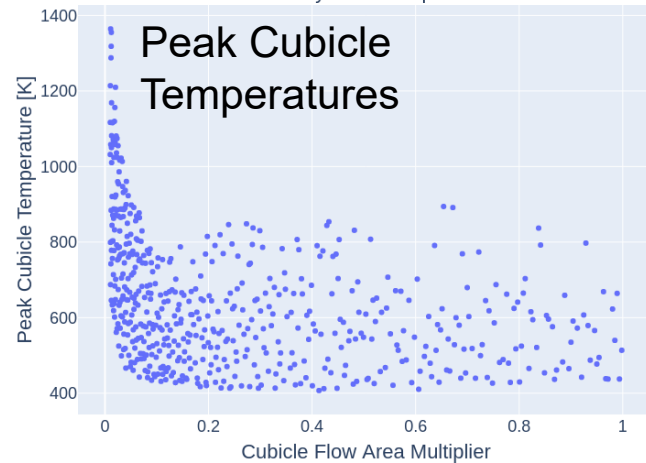
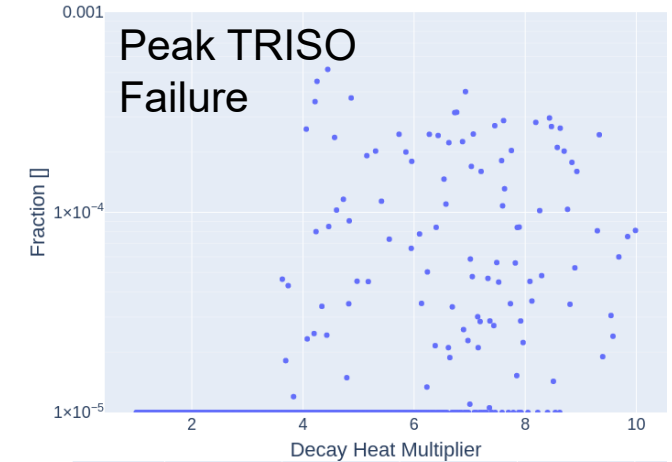
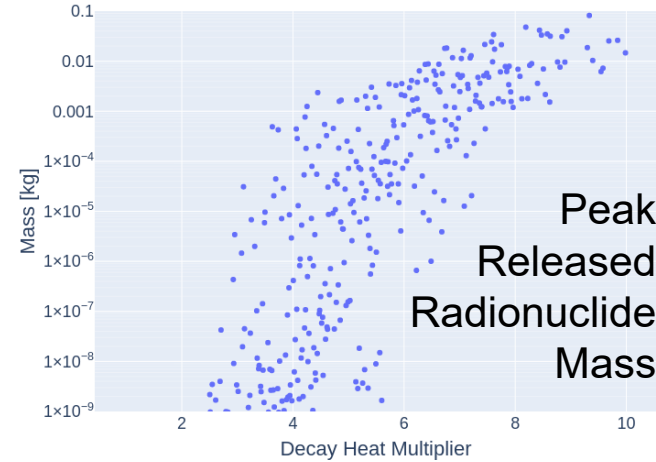
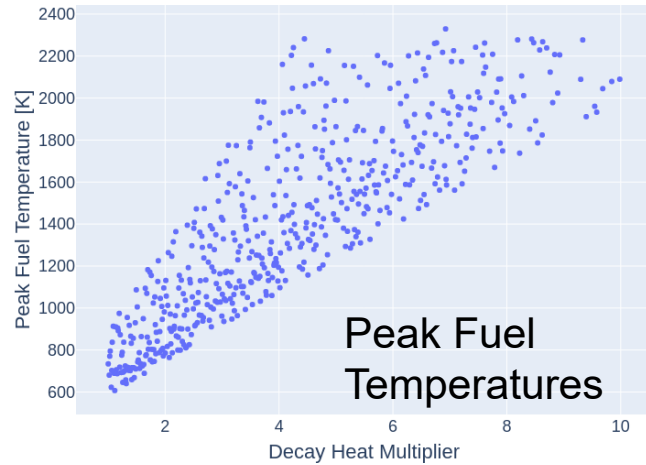

- Decay heat multiplier strongly impacts quantities of interest
- Cubicle flow area multiplier also exhibits a notable impact on quantities of interest
- Impact by other sensitivity parameters on selected quantities of interest is likely present, but smaller in magnitude and so not observed

Summary



U.S. NRC

 **OAK RIDGE**
National Laboratory



Sandia
National
Laboratories

Conclusions

- Illustrated HTGR fuel cycle modeling capabilities in MELCOR to demonstrate code readiness
 - Parametric sensitivity study demonstrated the impact of UF_6 cylinder rupture characteristics on material transport (i.e., vapor fraction)
 - Event sensitivities indicate that used fuel storage requires large mass flows to maintain cooling on loss of power which presents a challenge for filtration
 - The spent fuel storage model is robust across analyzed event sensitivities
 - Parametric sensitivity study indicates that decay heat and cubicle flow blockage drive peak fuel temperatures and by extension other key quantities of interest in spent fuel storage tanks during a loss of power accident with combined tank and cubicle rupture
- Demonstrated MELCOR modeling practices for a multiple systems highlighting various stages of the HTGR fuel cycle
 - Model of UF_6 cylinder rupture
 - Model of multiple fuel storage tank operational modes and transients
 - Input of detailed ORIGEN radionuclide inventory data from ORNL
 - Develop MELCOR input model for exploratory analysis
 - Fast-running calculations facilitate sensitivity evaluations
- Communicated an understanding of existing non-LWR fuel cycle modeling capabilities and safety

Closing Remarks

- Demonstration of NRC's Code Readiness for Reviewing non-LWRs
 - HTGR Nuclear Fuel Cycle

- Next Steps
 - Public Reports
 - SFR Workshop

Backup: Lists of scenarios for the individual stages

E1: Enrichment – Scenarios

NUREG/CR-6410 scenarios

- E1.1 – HALEU enriched UF_6 cylinder overfilled and heated → UF_6 release with rupture of cylinder
- E1.2 – HALEU enriched UF_6 cylinder dropped → UF_6 liquid and vapor leaks from damaged cylinder

Scenarios from National Enrichment Facility (NEF) SER

- E1.3 – Seismic or other initiating event causing pipe rupture → UF_6 release
- E1.4 – Fire UF_6 handling hall → UF_6 release
- E1.5 – Unintended accumulation of enriched U → inadvertent nuclear criticality

T1: Transportation of UF₆ – Scenarios

Criticality:

- T1.1: Water surrounding array of canisters at optimal moderator-to-fuel ratio and optimal canister → criticality
- T1.2: Water ingress into array of canisters at optimal moderator-to-fuel ratio → criticality
- T1.3: Water surrounding into array of canisters with simultaneous water ingress at optimal moderator-to-fuel ratio → criticality
- T1.4: Low ambient temperatures → criticality at low temperatures
- T1.5: Damage to container due to drop → reduced container array spacing → criticality
- T1.6: Loss of overpack due to vehicle accident → reduced container array spacing → criticality

Release:

- T1.7: Fire due to vehicle accident → melt/burn/combustion of overpack (foam insulation)
- T1.8: Fire due to vehicle accident → combustion of melting of plugs → venting of gases
- T1.9: Impact due to vehicle accident → rupture of container → release of UF₆ gas

F1: Fabrication of TRISO Particles – Scenarios

Fire Scenarios

- F1.1 Sparks → HMTA (Hexamethylenetetramine) explodes
- F1.2 Sparks → HMTA catches fire
- F1.3 Heat/ignition source → Uranyl nitrate solution catches fire
- F1.4 Heat/ignition source → TCE explosion
- F1.5 Heat/ignition source → Acetylene explosion during coating process
- F1.6 Heat/ignition source → Propylene explosion during coating process
- F1.7 Heat/ignition source → MTS (Methyltrichlorosilane) explosion during coating process

Chemical Scenarios

- F1.8 System leak → Uranyl nitrate solution thermal decomposition produces toxic nitrogen oxides which escapes into unventilated room
- F1.9 System leak → Uranyl nitrate solution spill
- F1.10 System leak → Silicone oil spill
- F1.11 System leak → TCE (Trichloroethylene) not being ventilated (thermal decomposition leads to toxic gases and vapors)
- F1.12 System leak → TCE spill
- F1.13 System leak → Ammonium hydroxide decomposes to nitrogen oxides in unventilated room
- F1.14 System leak → Ammonium hydroxide spill
- F1.15 Water ingress → MTS reaction with water
- F1.16 System leak → MTS leaks in unventilated room

Criticality Scenarios

- F1.17 Improper handling of uranium nitrate hexahydrate (UNH) solution → criticality
- F1.18 Flooding or water ingress → oxide fuel storage → criticality
- F1.19 Buildup of material in ducts or process stages → criticality

F2: Fabrication of Fuel Pebbles – Scenarios

Fire Scenarios

- F2.1 Abrasion and graphite dust → Fire
- F2.2 Air ingress during heat treatment → Fire

Chemical Scenarios

- F2.3 Water ingress → corrosion of pebbles

Criticality Scenarios

- F2.4 Improper storage of fuel pebbles → criticality (unexpected large enrichment, addition of moderator pebbles, water ingress, water flooding storage room, etc.)
- F2.5 Improper handling of TRISO particles → criticality

Downstream Considerations

- Too many damaged coated particles leading to “free fuel”
- Mechanical failure of pebble (cracks formed in pebble)
- Graphite impurities and density

T2: Transportation of Fresh Fuel Pebbles – Scenarios

Criticality:

- T2.1: Water surrounding array of canisters at optimal moderator-to-fuel ratio and optimal canister → criticality
- T2.2: Water ingress into array of canisters at optimal moderator-to-fuel ratio → criticality
- T2.3: Water surrounding into array of canisters with simultaneous water ingress at optimal moderator-to-fuel ratio → criticality
- T2.4: Ambient temperatures vary between -40°C and 38°C → criticality at low temperatures
- T2.5: Container drop → damage to container → reduced container array spacing → criticality
- T2.6: Vehicle accident → damage to container with release of fuel pebbles → re-arrangement of fuel pebbles from all containers on vehicle → criticality

Release:

- T2.7: Vehicle accident → fire → fire of fuel pebble graphite
- T2.8: Vehicle accident → fire → extinguishing water comes into contact with graphite at high temperature → graphite corrosion and development of graphite dust

U1: Fresh Fuel Staging and Loading – Scenarios

Criticality

- U1.1: Water surrounding array of canisters at optimal moderator-to-fuel ratio and optimal canister → criticality
- U1.2: Water ingress into array of canisters at optimal moderator-to-fuel ratio → criticality
- U1.3: Water surrounding into array of canisters with simultaneous water ingress at optimal moderator-to-fuel ratio → criticality
- U1.4: Misplacement of array of graphite pebble and fuel pebble containers → additional moderation due to graphite moderator → criticality
- U1.5: Damage to container due to drop of container → reduced container array spacing → criticality
- U1.6: Fire in pebble handling chamber → fire of fuel pebble graphite
- U1.7: Fire in pebble handling chamber → extinguishing water comes into contact with graphite at high temperature → graphite corrosion and development of graphite dust
- U1.8: Drop of pebbles while filling them into hopper → damage of pebbles → generation of graphite dust

U2: Power Production Including Online Refueling – Scenarios

Release:

- U2.6: FHSS pipe rupture → Pebbles come out out of the reactor with high temperature and pressure → oxidation of graphite in contact with air → pebble damage with fission product release
- U2.6: Fps escaped from pebbles adsorb into graphite dust (dust generated by pebble wear, fracture, irradiation sputtering, and corrosion) → graphite dust flows in the primary circuit with the helium, deposits on the surface of the reactor components → loss of coolant causes release of dust-gas mixture, and therefore fission product release
- U2.7: Air ingress into core
- U2.8: Chemical attack of TRISO layers and graphite (by steam) → graphite oxidation
- U2.9: Graphite dust catches fire from sparks or heat
- U2.10: Broken pebble gets stuck in reactor → fission product product release into He coolant

U2: Power Production Including Online Refueling – Scenarios

Criticality:

- U2.1: Failure in FHSS system → additional pebbles enter core → criticality
- U2.2: Failure in BUMS → pebbles with low burnup replaced by fresh pebbles → too many fresh fuel pebbles enter the core → criticality
- U2.3: Failure in CUD → pebbles are not removed from reactor, but still added on top → criticality
- U2.4: Seismic events → reorientation of pebbles (consider pebble cone in upper core) → criticality
- U2.5: Water steam ingress into core w/o CR insertion → criticality

Heat removal:

- U2.11: Accumulation of hot pebbles in FHSS pipes at high temperatures and pressure (“pebble jam”) due to error in FHSS or stuck pebbles due to a damaged or swollen pebble → temperature increase
- U2.12: depressurized loss of forced circulation (covered in Vol.3)
- U2.13: Blockage of fuel element coolant channel due graphite failure/spalling (channel distortion) → temperature increase → fuel pebble failure

U4: Onsite Discharged Pebble Storage – Scenarios

Criticality:

- U4.1: Graphite pebbles are misloaded into fuel pebble storage → criticality
- U4.2: BUMS malfunction → pebbles with lower burnup than discharge burnup are misloaded into fuel pebble storage → criticality
- U4.3: Water ingress into used fuel tank → criticality
- U4.4: Tank rupture with no tube collapse → reorientation of pebbles → criticality
- U4.5: Tank rupture with central tube collapse → reorientation of pebbles → criticality

Heat removal:

- U4.6: BUMS malfunction → pebbles with higher burnup than discharge burnup are misloaded into fuel pebble storage → increased temperature from decay heat
- U4.7: Failure of the active cooling system → passive cooling system takes over through natural convection → slightly higher fuel and structure temperatures
- U4.8: Failure of the passive cooling system because of blockage of the natural convection paths → high temperature increase of fuel and structure
- U4.9: Dropping of pebbles within the FHSS → damage of fuel pebbles → pebble jammed → insufficient cooling

U4: Onsite Discharged Pebble Storage – Scenarios

Release:

- U4.10: Manufacturing defects of fuel pebbles → release of fission products from defective pebbles
- U4.11: Dropping of pebbles within the FHSS → damage of fuel pebbles → fission product release and graphite dust
- U4.12: Dropping of pebbles inside the storage tank → damage of fuel pebbles → fission product release and graphite dust
- U4.13: Tank rupture with no tube collapse → damage of fuel pebbles → fission product release and graphite dust
- U4.14: Tank rupture with central tube collapse → damage of fuel pebbles → fission product release and graphite dust
- U4.15: Gamma radiation from fuel pebbles cause radiolysis of the air → resulting in extremely corrosive elements such as nitric acid and ozone in the air → graphite corrosion → fuel pebble failure → fission product release
- U4.16: Sparks from machinery, equipment, electrical circuits, or human activities → fire
- U4.17: Radiolysis of the coolant air → evolution of explosive gas mixtures → explosion
- U4.18: Off-gassing or volatilization → evolution of explosive gas mixtures → explosion
- U4.19: Collision of vehicles or suspended loads with FHSS pipes → pipe rupture → pebble drop → fission product release and graphite dust
- U4.22: Collision of vehicles or suspended loads with storage tank → damage to tank → damage to pebbles inside tank → fission product release and graphite dust

Accidents Selected for Initial SCALE/MELCOR Calculations

	Fuel Cycle Stage	Accident	SCALE/MELCOR
Front-end	E1 – Uranium Enrichment	Rupture of a HALEU enriched UF ₆ cylinder on storage dock	MELCOR – transport of UF ₆
	T1 – Transportation of UF ₆	Water ingress into array of canisters at optimal moderator to fuel ratio → criticality	SCALE – criticality
	T2 – Transportation of Fresh fuel Pebbles	Damage to container due to drop of container → reduced container array spacing → criticality	SCALE – criticality
Fuel Handling	U2 – Uranium Utilization / Online Refueling	FHSS pipe rupture, pebbles exit out of the reactor with high temperature and pressure, leading to graphite & air interaction	SCALE – pebble inventory MELCOR – release paths
Back-end	U4 – Onsite Discharged Pebble Storage	Collision of vehicle or suspended load with storage tank causing damage to tank and damage to pebbles inside tank, causing fission product and graphite dust release	SCALE – spent fuel tank inventory MELCOR – release paths

SCALE Backup



U.S. NRC

 **OAK RIDGE**
National Laboratory



Sandia
National
Laboratories

Most limiting hypothetical condition is without PSP

Single cylinder (no PSP) with varying water density

DN30-10

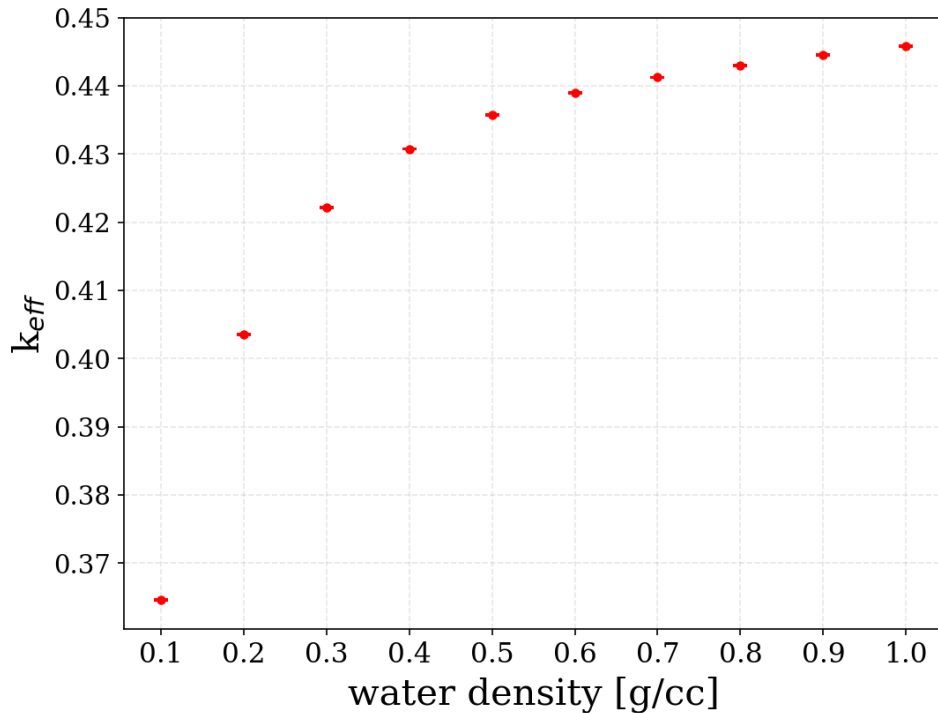

DN30-20

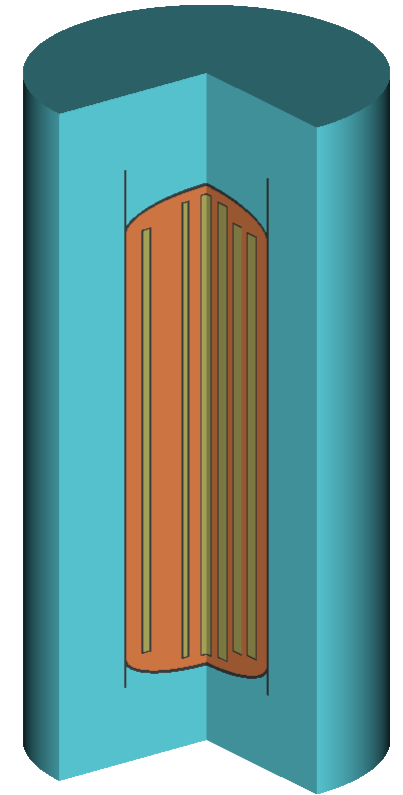
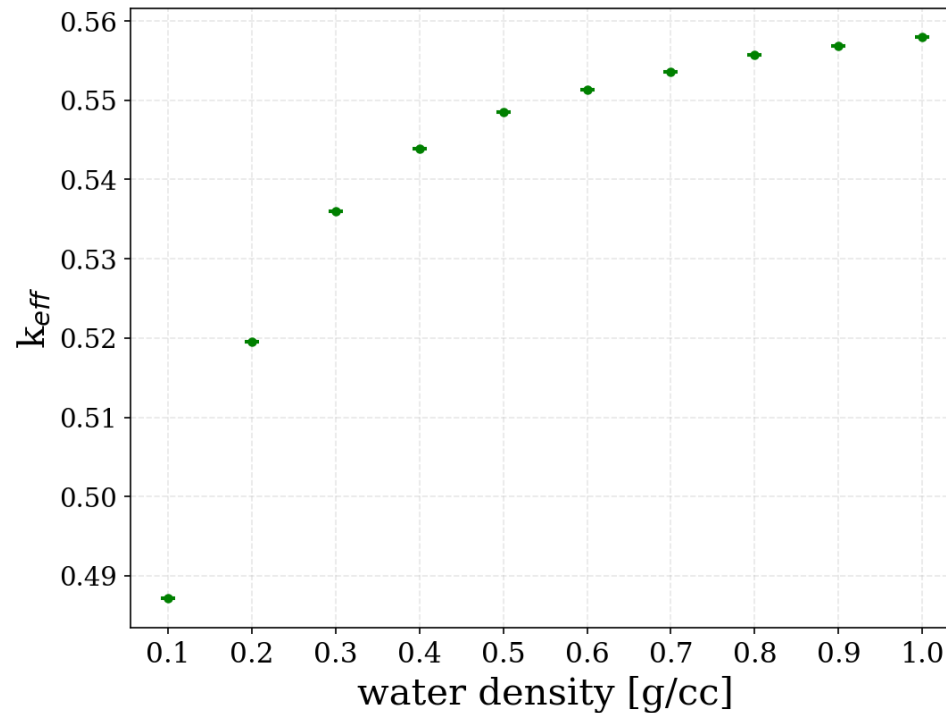

SCALE model of single BN30-10 package surrounded by 30 cm of water

Full water density results in the most reactive configuration.

Reactivity sensitivity study for various VP-55 materials

- Some of the insulation material variables were varied within the specified limits to understand their impact on the criticality.
- Calculations were performed using ENDF/B-VII.1 252g MG

Case	Reference	$k_{\text{eff}} \pm \text{sigma}$	Δk (pcm)
Reference	-	0.30416 +/- 0.0001	(ref)
Fiberglass type E	Fiberglass type R	0.25083 +/- 0.0001	-5333
Fiberglass type C	Fiberglass type R	0.25597 +/- 0.0001	-4819
Fiberglass type R, wt=36%	wt = 50%	0.30078 +/- 0.0001	-338
Polyurethane density 11 PCF*	5 PCF	0.30308 +/- 0.0001	-108
Polyurethane with TSL data of H in water**	h-poly**	0.29958 +/- 0.0001	-458
Polyurethane without TSL data of H**	h-poly**	0.29651 +/- 0.0001	-766

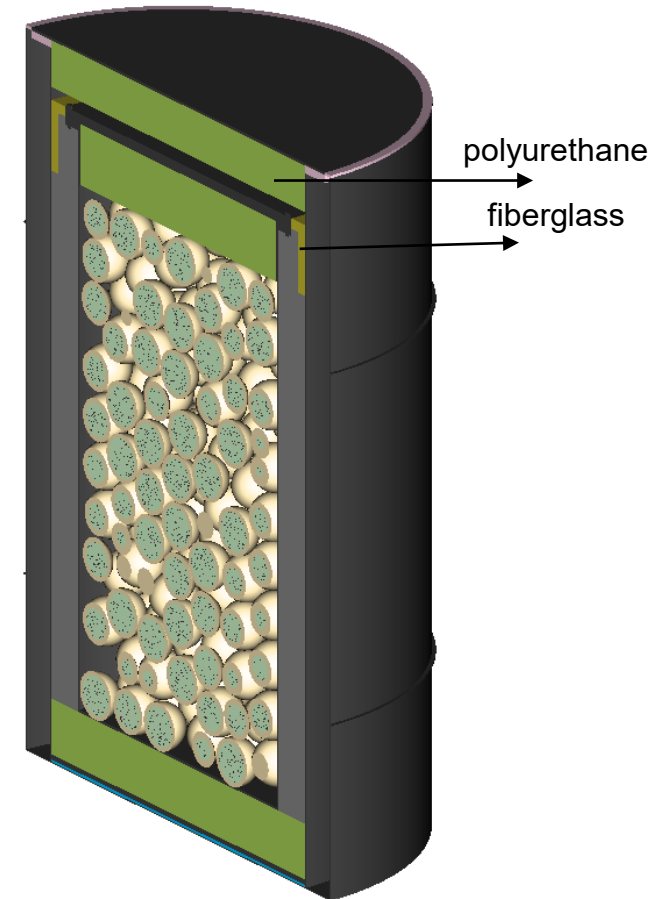

3D SCALE VP-55 model

* PCF: pounds per cubic foot, a unit used for measuring foam densities

** In the absence of thermal scattering law (TSL) data for H in polyurethane, the TSL data for H in polyethylene was applied. To assess the impact on the choice of TSL data, tests were run with (1) TSL data for H in water, and (2) no TSL data for H (H as free gas).

Additional water/flooding scenarios for VP-55

a) Impact of water surrounding the containers

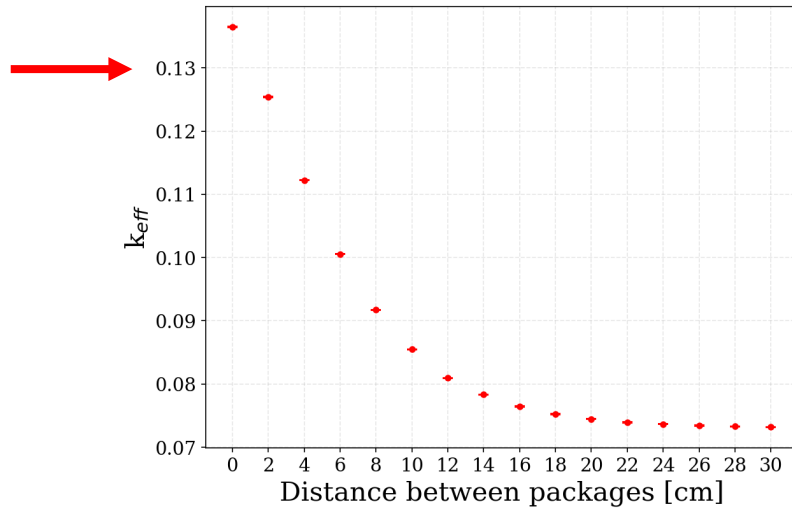

b) Impact of water surrounding the containers and inside outer drum

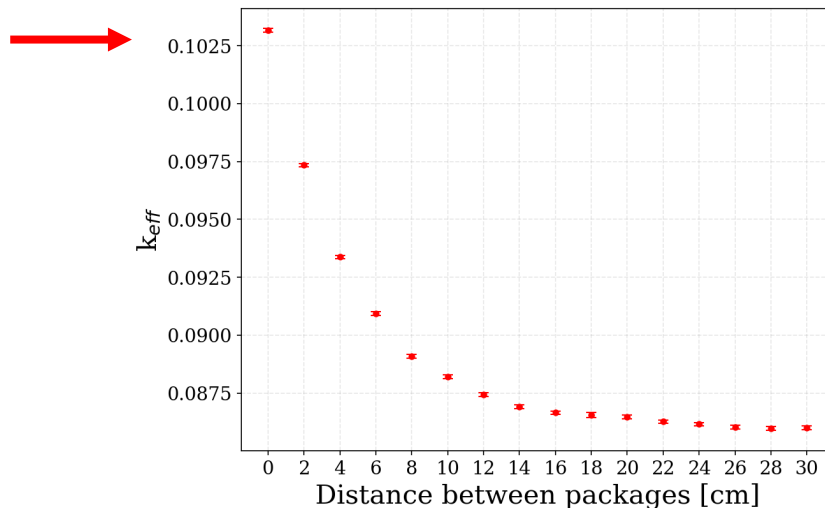

c) Impact of water ingress into the container

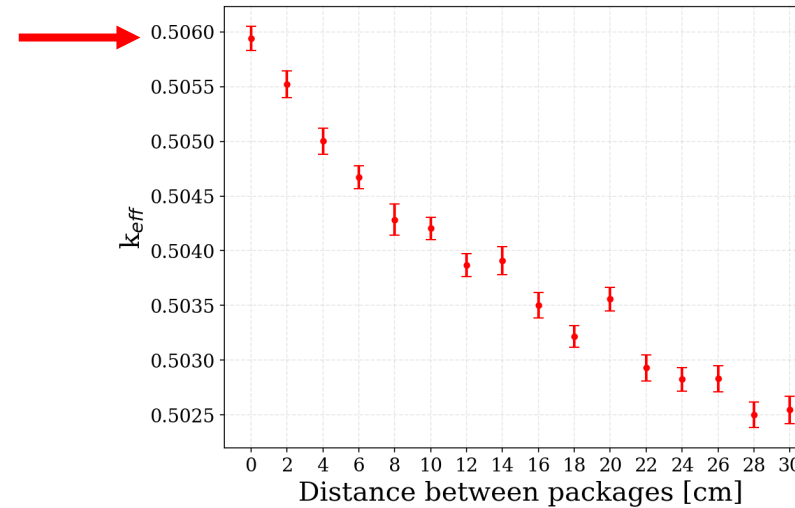

k_{eff} much higher than air-only case

d) Impact of flooding: water surrounding containers and water ingress into the container

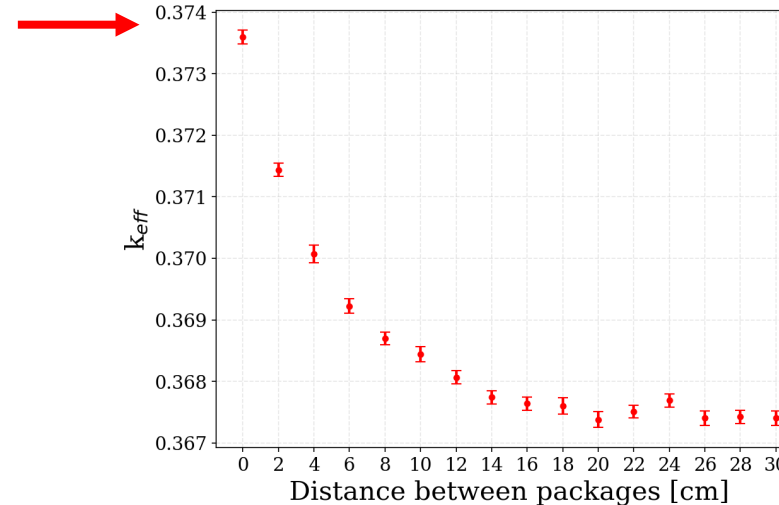

For all cases, largest k_{eff} found when cylinders are touching (unlike the air-only case)

Impact of packing fraction on criticality for VP-55

PF = 0.45 (298 pebbles)

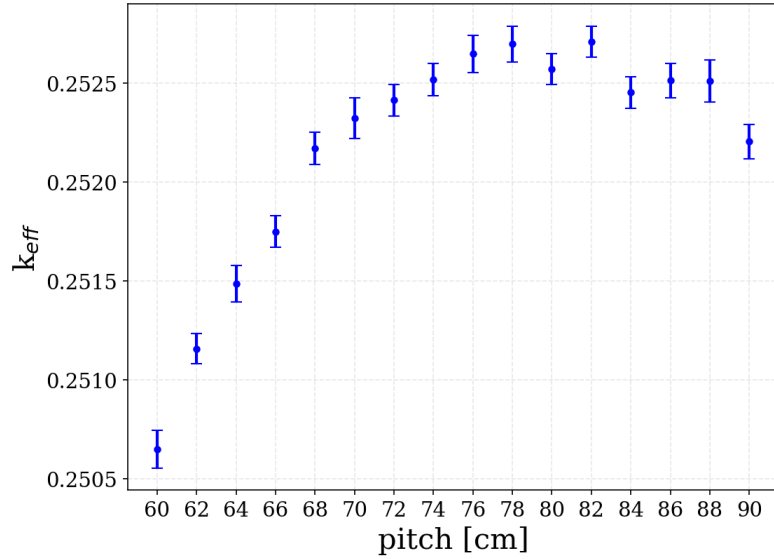

Optimal pitch in air is not when cylinders touching each other

PF = 0.55 (364 pebbles)

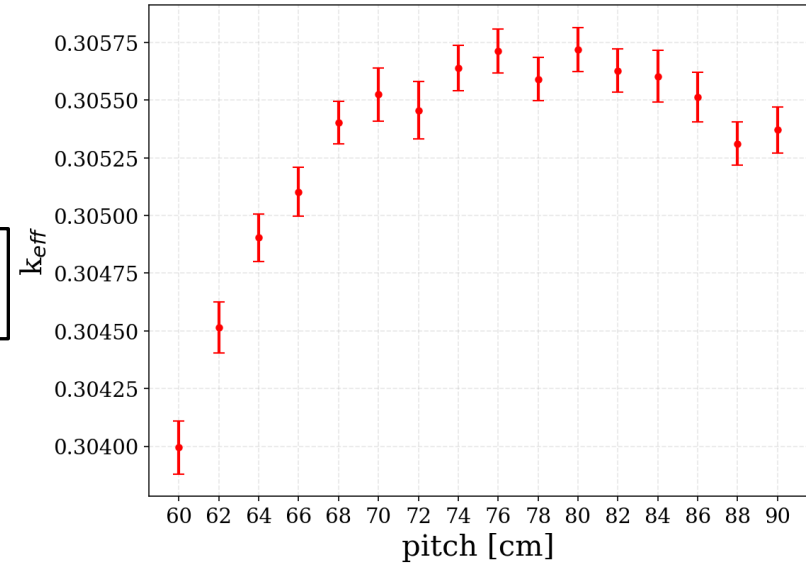

PF = 0.50 (331 pebbles)

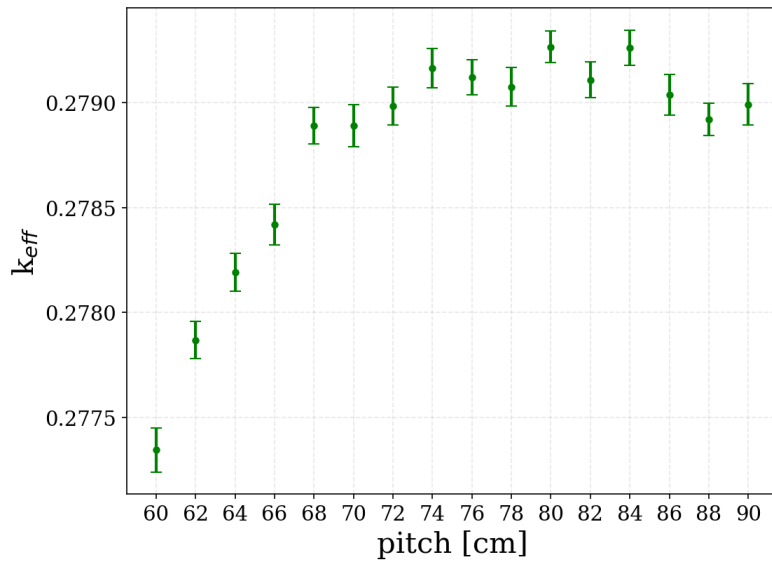

k_{eff} for all arrangements is far below 0.95

PF = 0.60 (397 pebbles)

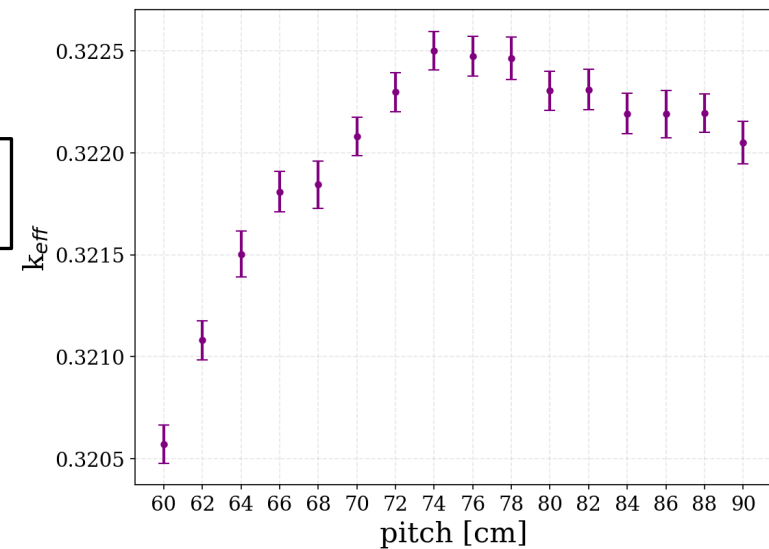

SCALE Criticality Calculations of VP-55

Impact of varying the enrichment on k_{eff}

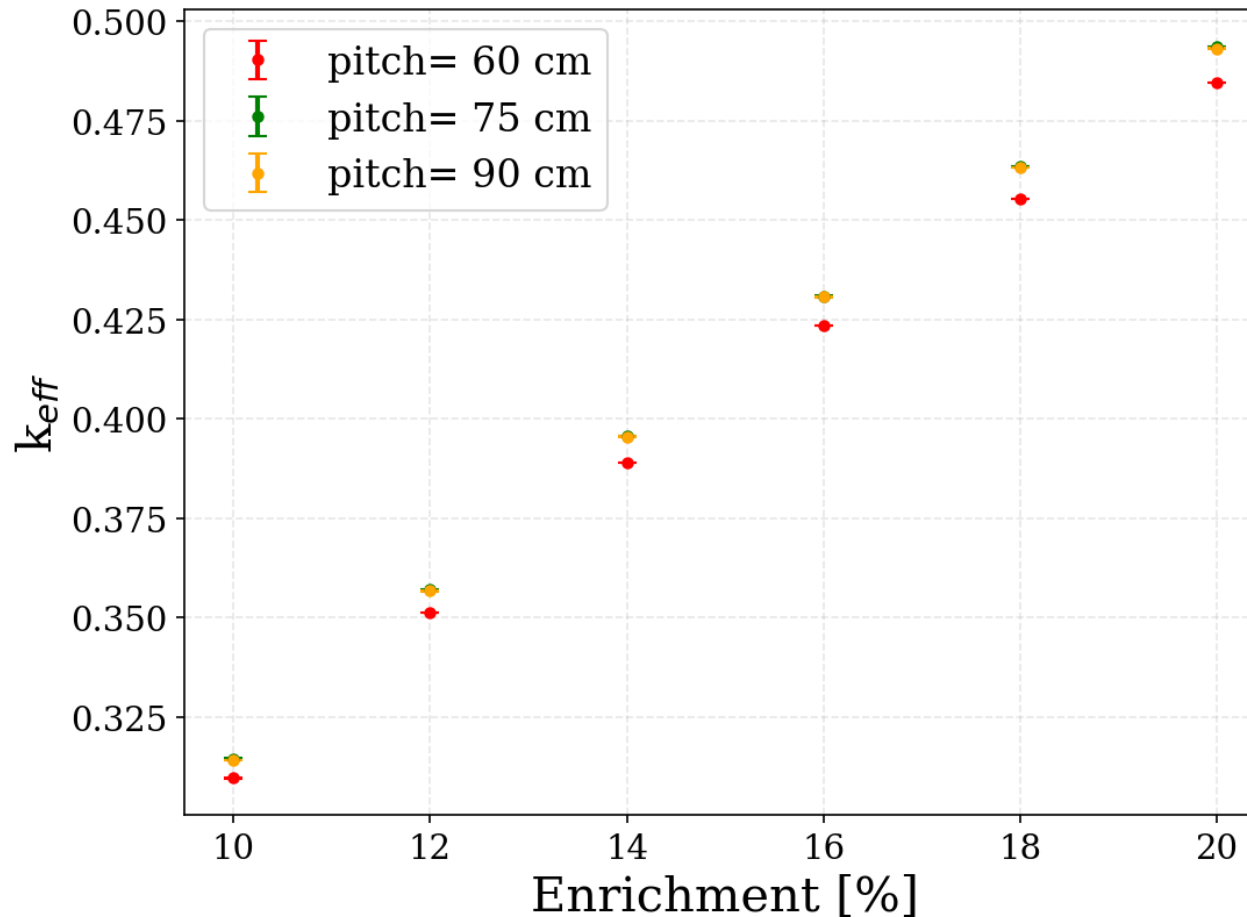

k_{eff} increases linearly with increasing the enrichment.

k_{eff} is more sensitive to the pitch with higher enrichment.

Decay heat of spent fuel inventory

Total decay heat of pebbles with different discharge time

Day of discharge

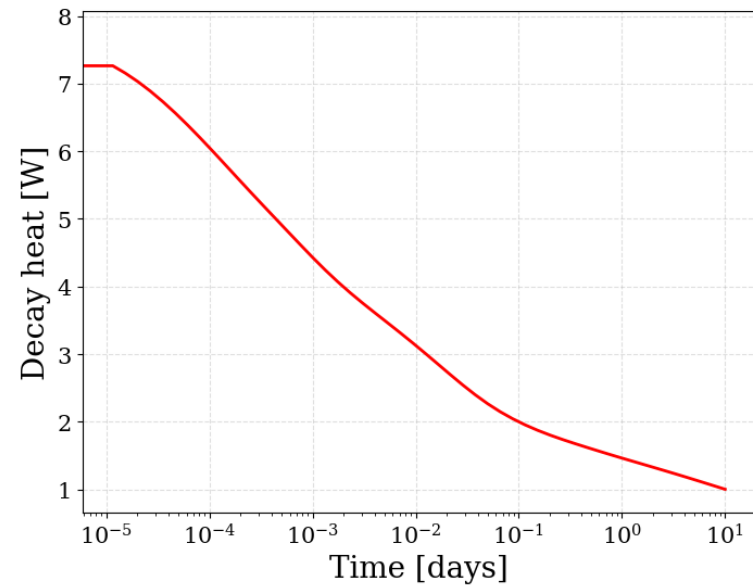

Top of tank

650 days after discharge

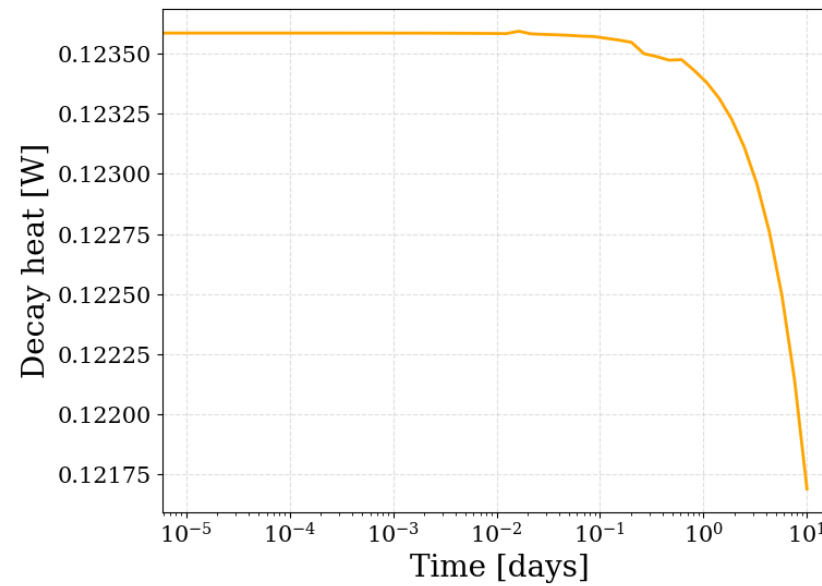

Middle of tank

1284 days after discharge

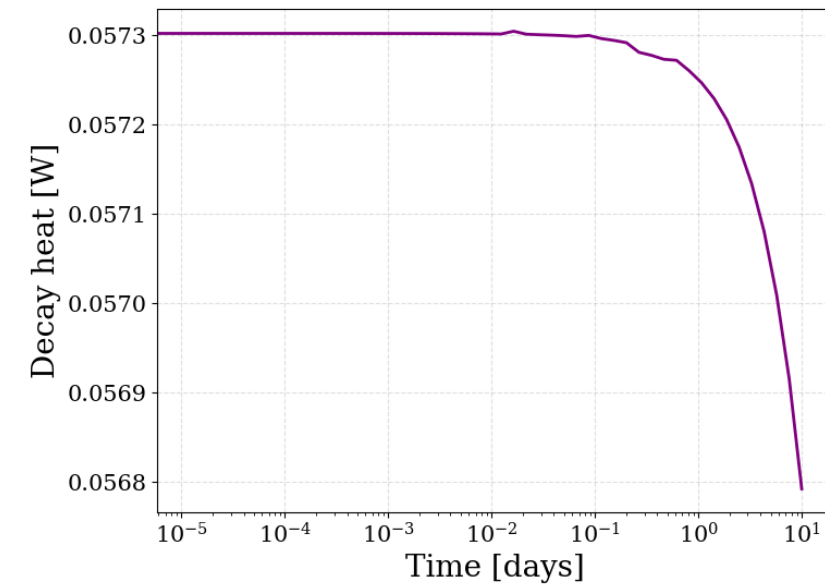

Bottom of tank

Equilibrium Core Inventory

Equilibrium Core Inventory Search:

1. Based on the benchmark specification in IAEA-TECDOC-1694*. Core is divided into 5 radial channels and 22 axial regions.
2. At full power and with the 24 control rods inserted 2.285 m below the bottom of the top reflector.
3. Pebble is circulated six times through the core before it is discharged.
4. After each pass, the fuel is reintroduced to the top of the core and equally distributed over any defined flow lines (or core positions).
5. Fuel flow lines are all parallel and all fuel flow speeds are the same (no variation in core residence time), independent of the radial and azimuthal position.
6. Pebble after discharged is cooled down for 7 days before re-inserted to the core.

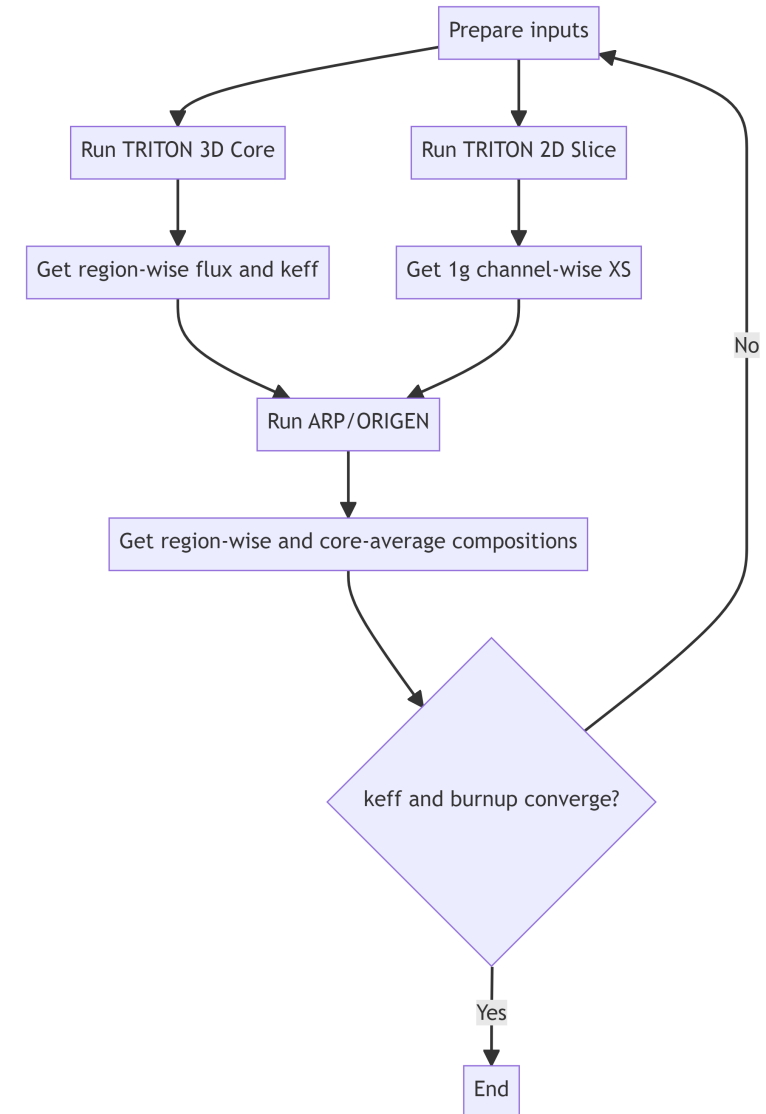

* INTERNATIONAL ATOMIC ENERGY AGENCY, Evaluation of High Temperature Gas Cooled Reactor Performance: Benchmark Analysis Related to the PBMR-400, PBMM, GT-MHR, HTR-10 and the ASTRA Critical Facility, IAEA-TECDOC-1694, IAEA, Vienna (2013)

Rapid inventory generation of retired pebbles*

Procedures followed for generating pebble discharge inventory

1. Generate **ORIGEN** reactor libraries
 - **TRITON** models were developed to generate ORIGEN reactor libraries.
 - Models have information about different channels.
 - Three fuel/reflector temperatures.
 - Up to 100 GWd/MTU with 28 burnup steps.
2. 20,000 random pebbles histories were generated, considering different radial channel and associated power distributions
 - Each history completes seven passes, each pass history is determined stochastically.
 - Channel at each pass was selected based on a discrete probability distribution that accounts for the difference of the volume fraction.
3. **ORIGAMI** used to simulate the 20,000 histories
 - 4.5 days of cooling time after the end of each pass.
 - Based on the fuel/reflector temperature of each axial zone of pass, **ORIGAMI** calls **ORIGEN** libraries to interpolate problem-dependent cross-sections.

* D. Hartanto, W. A. Wieselquist, S. E. Skutnik, P. W. Gibbs (2022), "[Uncertainty Quantification of Pebble's Discharge Burnup and Isotopic Inventory Using SCALE](#)," Proc. ANS Winter Meeting, Phoenix, AZ, November 13–17, 2022.

Decay heat of spent fuel tank

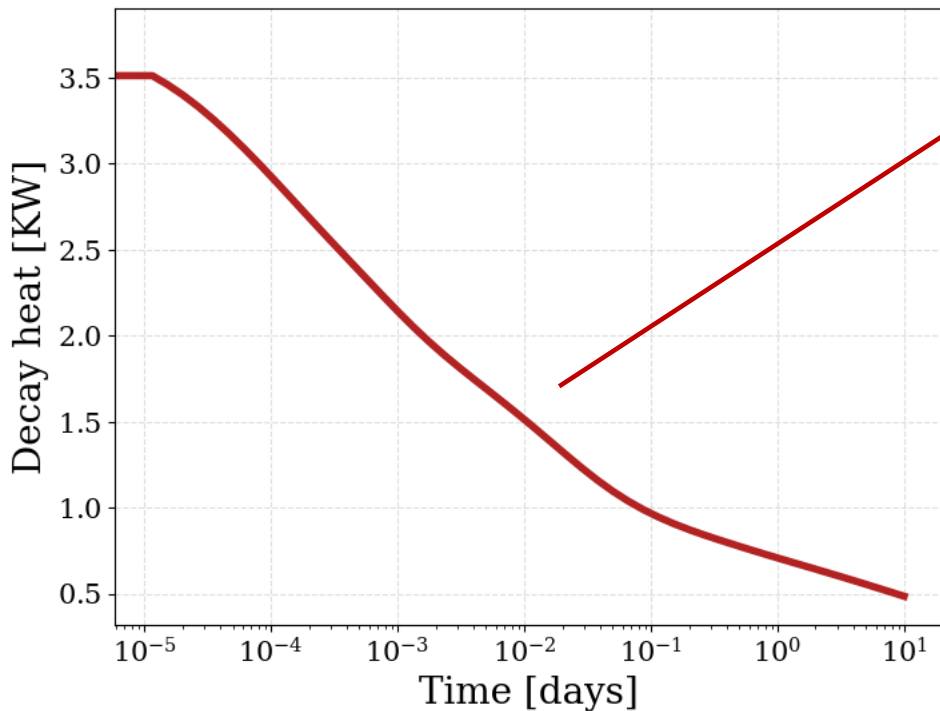

Decay heat of top slice

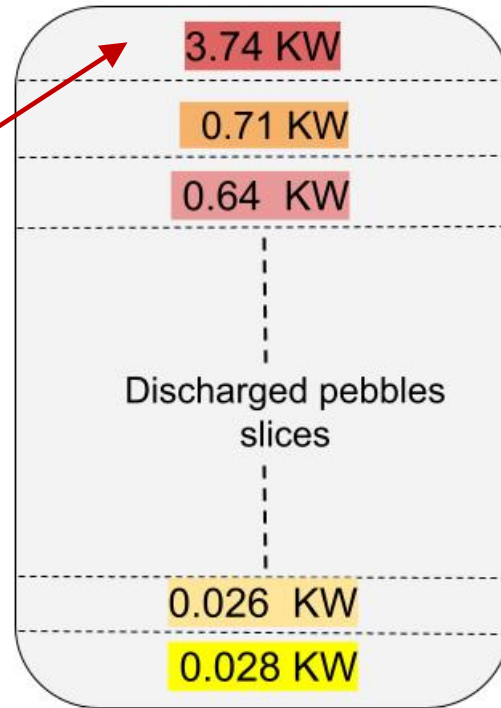

Decay heat of spent fuel tank that has just been fully filled

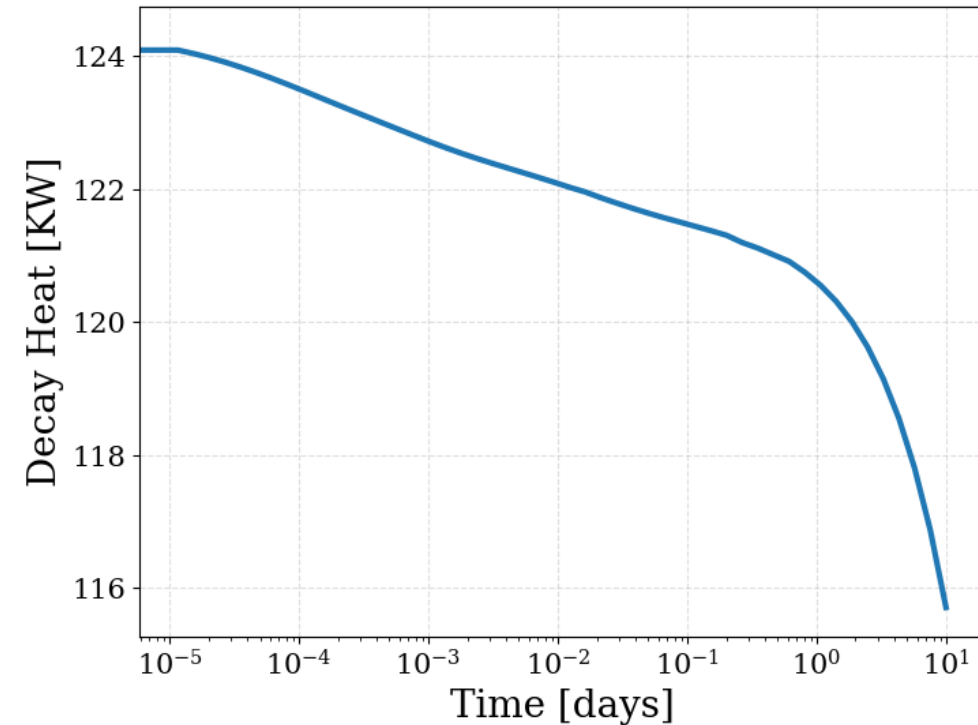

Total decay heat of SFT (sum of all slices; all 620,000 pebbles)

Top contributors to decay heat of spent fuel tank

Day of discharge

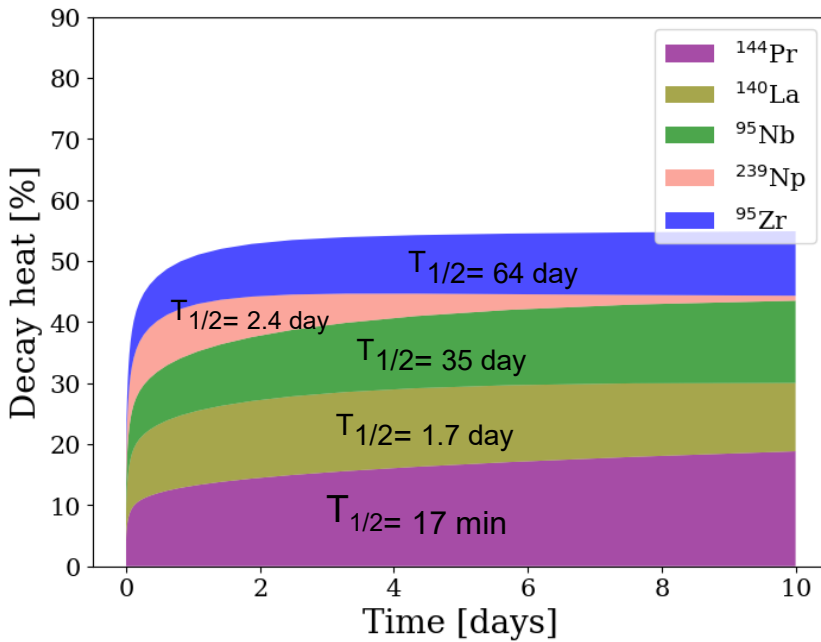

Top of tank (3.7 kW at t=0)

650 days after discharge

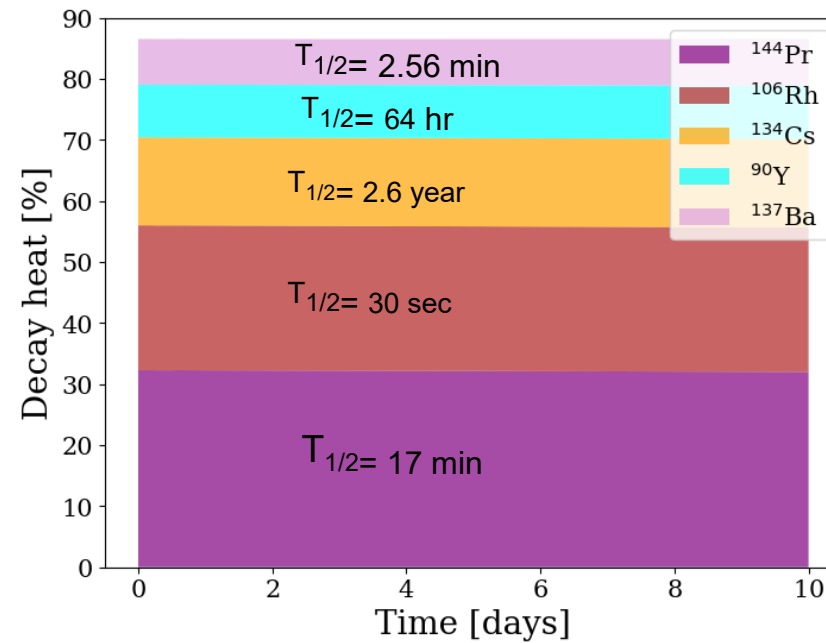

Middle of tank (0.06 kW at t=0)

1284 days after discharge

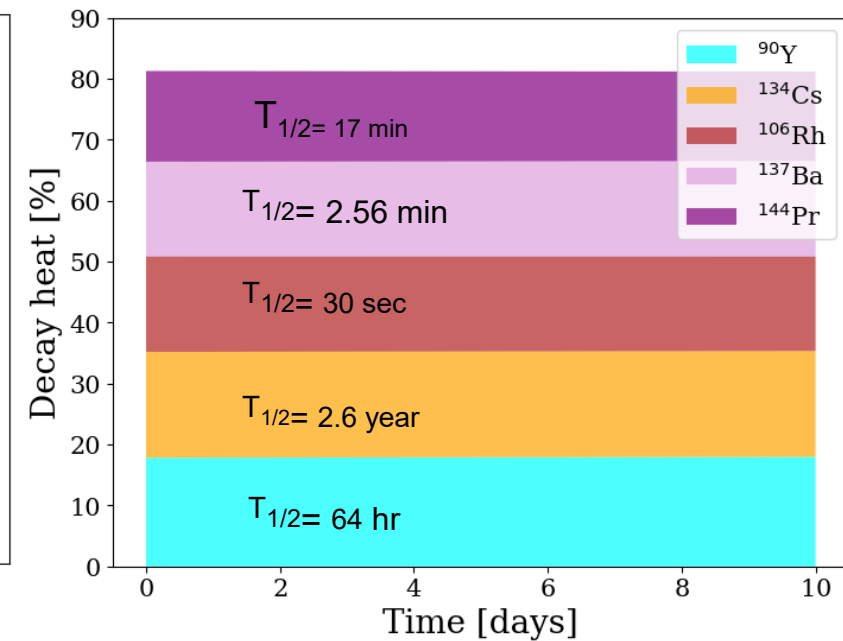

Bottom of tank (0.03 kW at t=0)

Spent fuel tank inventory calculation

1-Prepare discharge inventory

ORIGEN

Blend the inventory of 20,000 discharged pebbles



2-Compute Inventory of each slice

ORIGEN

Decay the discharge inventory using for 1284 days



3- Progress the accident for 10 days

ORIGEN

Decay resulting inventory at each time step for additional 10 days



4- Generate inventory file for MELCOR

OBIWAN

Convert the binary concentration file to **II.JSON** format

- The new **ORIGEN blend** block is used.
- Blended $9/10^6$ of each pebble's mass to compute average discharge inventory of one pebble.
- Discharge cutoff = 85 GWd/MTU.

- Time step=1 day, each day represents a slice in the tank
- t=0 day → last discharged (top of the tank)
- t =1284 day → First discharged (bottom of the tank).

- t=0 is the immediately after the accident

MELCOR Backup



U.S. NRC

 **OAK RIDGE**
National Laboratory



Sandia
National
Laboratories

HTGR Components

Pebble Bed Reactor Fuel/Matrix Components

- Fueled part of pebble
- Unfueled shell (matrix) is modeled as separate component
- Fuel radial temperature profile for sphere

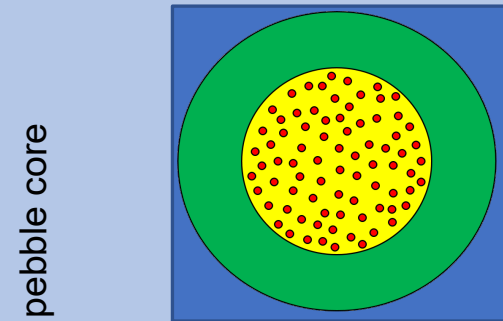

Fueled pebble core

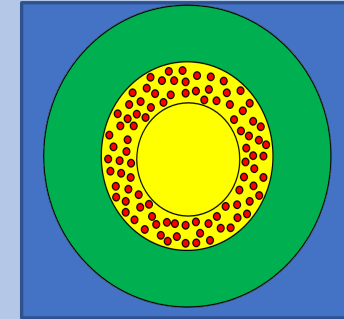
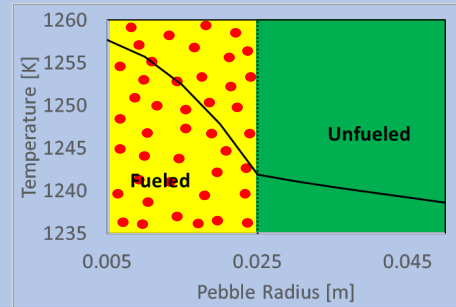

Unfueled pebble core

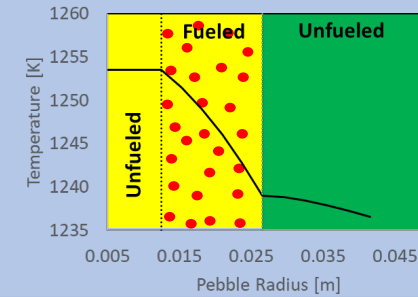

Legend

- TRISO } Fuel (FU)
- GRAPHITE } Fuel (FU)
- GRAPHITE Matrix (MX)
- Fluid B/C

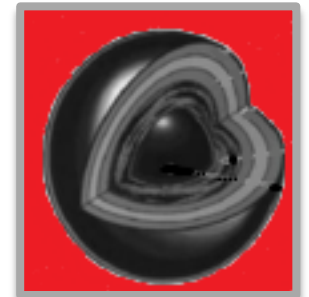

TRISO (FU)

TRISO Radionuclide Release Model

- Recent failures – particles failing within latest time-step (burst release, diffusion release in time-step)
- Previous failures – particles failing on a previous time-step (time history of diffusion release)
- Contamination and recoil

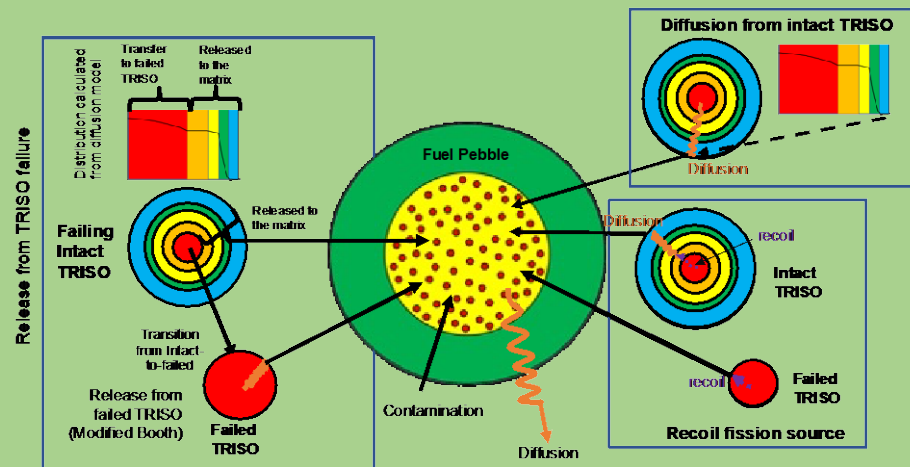

Sub-component model for zonal diffusion of radionuclides through TRISO particle

Transient/Accident Solution Methodology

Stage 0:
Normal Operation
Establish thermal state

Establish steady state temperatures and pressures throughout the problem domain

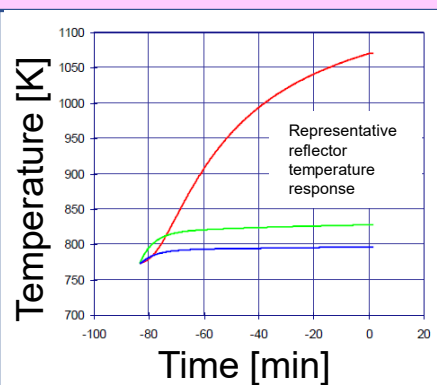

Stage 1:
Normal Operation
Diffusion Calculation

Establish steady state distribution of radionuclides in TRISO particles and matrix

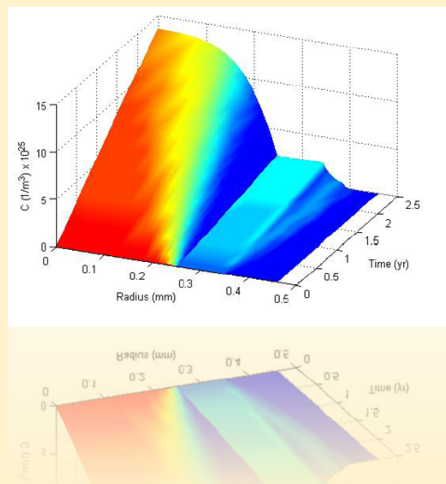

Stage 2:
Normal Operation
Transport Calculation

Calculate steady state distribution of radionuclides and graphite dust throughout system (deposition on surfaces, convection through flow paths)

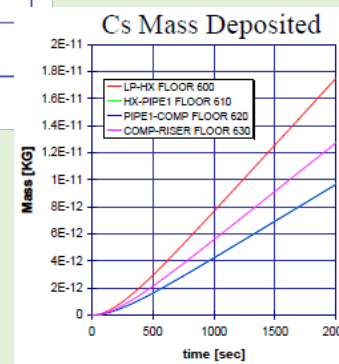
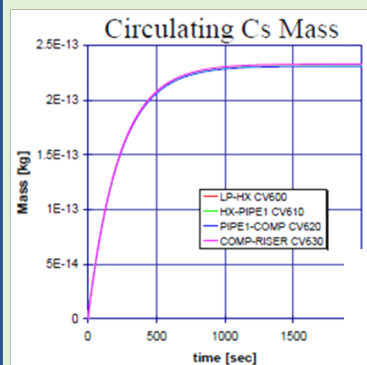

Example:
PBMR-400 Cs
Distribution in
Primary
System

Stage 3:
Accident
Diffusion & Transport calculation

Calculate accident progression and radionuclide release

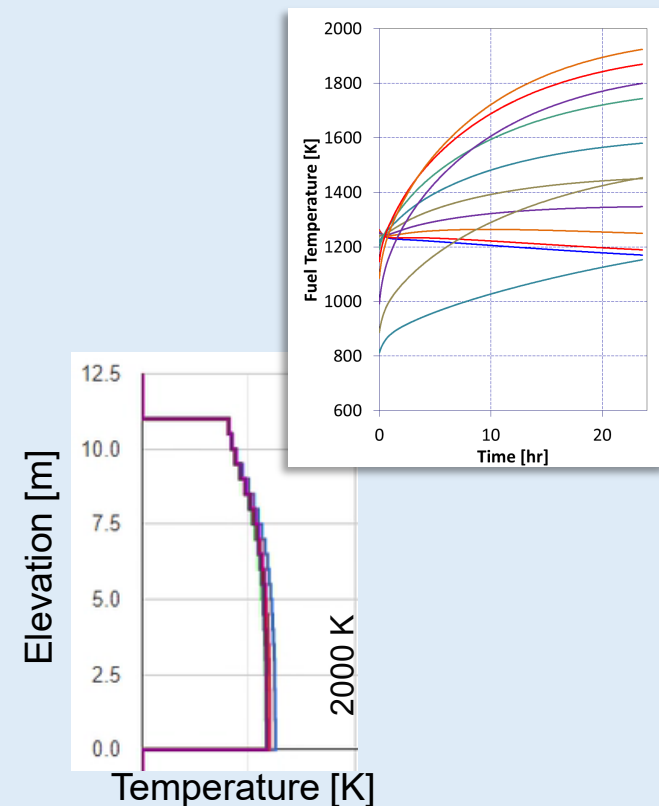

HTGR Radionuclide Diffusion Release Model

Intact TRISO Particles

- One-dimensional finite volume diffusion equation solver for multiple zones (materials)
- Temperature-dependent diffusion coefficients (Arrhenius form)

$$\frac{\partial C}{\partial t} = \frac{1}{r^n} \frac{\partial}{\partial r} \left(r^n D \frac{\partial C}{\partial r} \right) - \lambda C + \beta \quad D(T) = D_0 e^{-\frac{Q}{RT}}$$

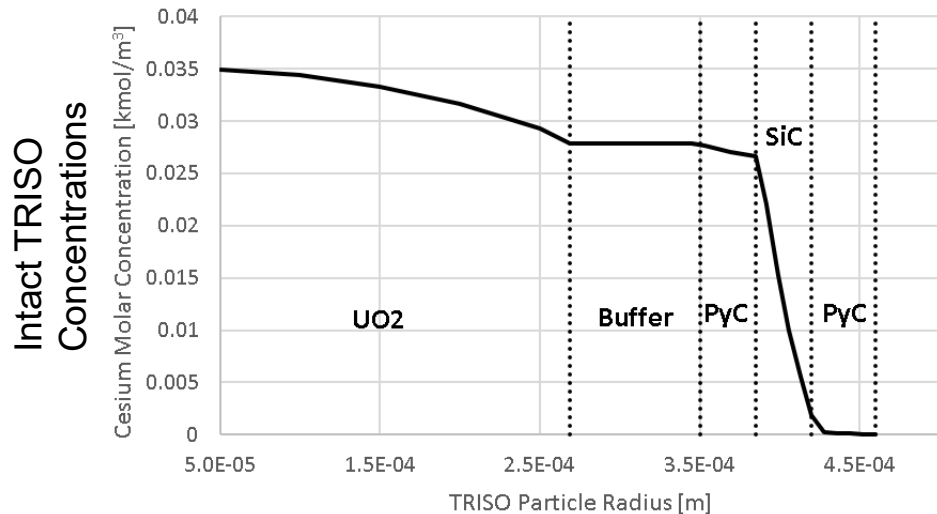
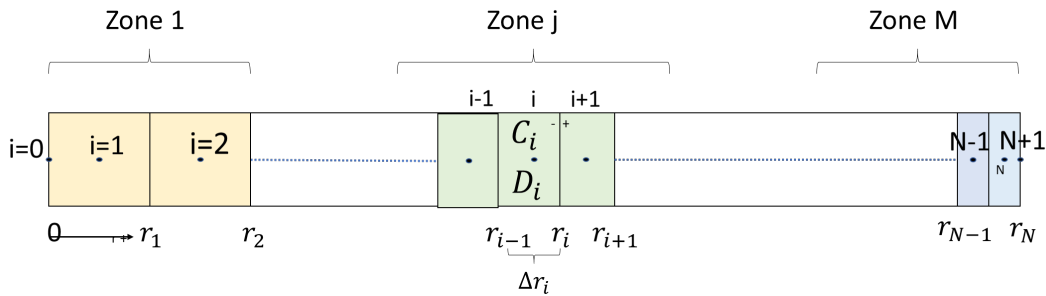

Diffusivity Data Availability

Radionuclide	UO ₂	UCO	PyC	Porous Carbon	SiC	Matrix Graphite	TRISO Overall	
Ag	Some	Not investigated	Some	Not found	Extensive	Some	Extensive	
Cs	Some		Some		Extensive	Some	Some	
I	Some		Some		Some	Not found	Not found	Not found
Kr	Some		Some		Not found	Some	Some	Some
Sr	Some		Some		Extensive	Some	Some	Some
Xe	Some		Some		Some	Some	Some	Not found

Data used in the demo calculation [IAEA TECDOC-0978]

Layer	FP Species							
	Kr		Cs		Sr		Ag	
	D (m ² /s)	Q (J/mole)	D (m ² /s)	Q (J/mole)	D (m ² /s)	Q (J/mole)	D (m ² /s)	Q (J/mole)
Kernel (normal)	1.3E-12	126000.0	5.6-8	209000.0	2.2E-3	488000.0	6.75E-9	165000.0
Buffer	1.0E-8	0.0	1.0E-8	0.0	1.0E-8	0.0	1.0E-8	0.0
PyC	2.9E-8	291000.0	6.3E-8	222000.0	2.3E-6	197000.0	5.3E-9	154000.0
SiC	3.7E+1	657000.0	7.2E-14	125000.0	1.25E-9	205000.0	3.6E-9	215000.0
Matrix Carbon	6.0E-6	0.0	3.6E-4	189000.0	1.0E-2	303000.0	1.6E00	258000.0
Str. Carbon	6.0E-6	0.0	1.7E-6	149000.0	1.7E-2	268000.0	1.6E00	258000.0

Iodine assumed to behave like Kr

CORSOR-Booth LWR scaling used to estimate other radionuclides

Graphite Oxidation

Steam oxidation

$$R_{OX,steam} = \frac{k_4 P_{H_2O}}{1 + k_5 P_{H_2}^{0.5} + k_6 P_{H_2O}}$$

Reactions

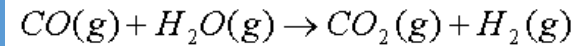
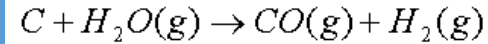

Air oxidation

$$R_{OX} = 1.7804 \times 10^4 \exp\left(-\frac{20129}{T}\right) \left(\frac{P}{0.21228 \times 10^5}\right)^{0.5}$$

Reactions

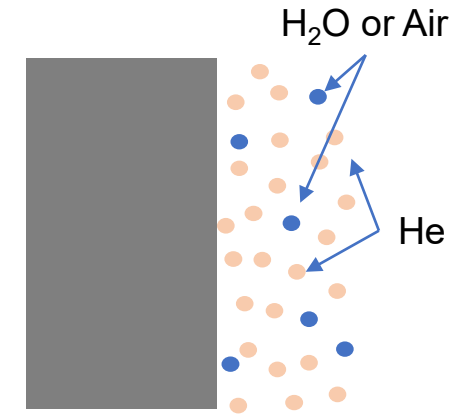
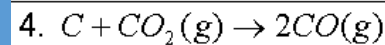
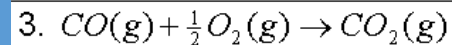
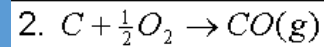
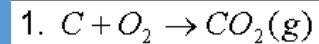

Both steam and air include rate limit due to steam/air diffusion towards active oxidation surface

R_{OX} is the rate term in the parabolic oxidation equation [1/s]

COR Intercell Conduction

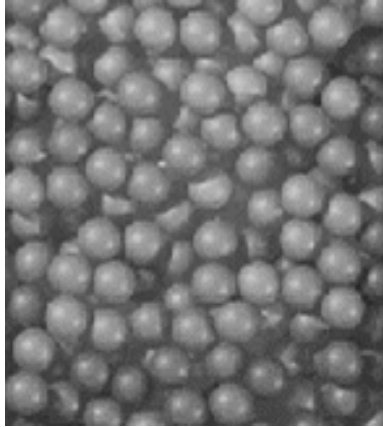

Effective conductivity prescription for pebble bed (bed conductance)

- Zehner-Schlunder-Bauer with Breitbach-Barthels modification to the radiation term

$$k_{eff} = (1 - \sqrt{1 - \epsilon}) \epsilon 4 \sigma T^3 D_p + (1 - \sqrt{1 - \epsilon}) k_f + \sqrt{1 - \epsilon} k_c(T, D_p, \epsilon, k_f, k_s, k_r)$$

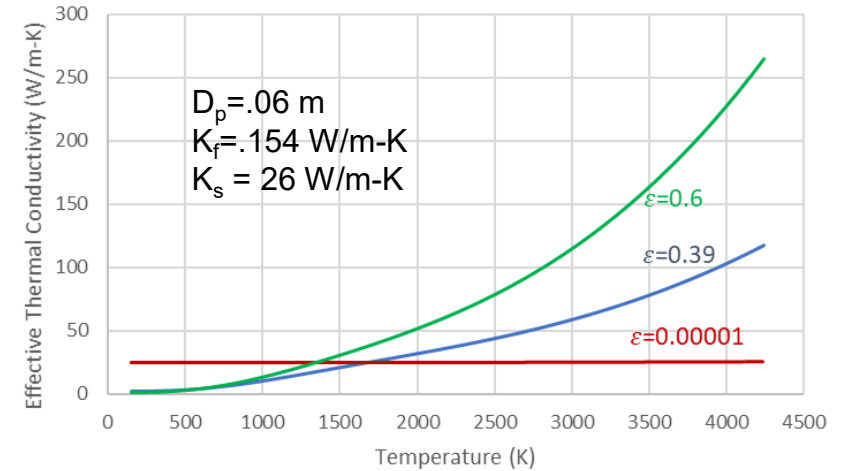

Effective conductivity prescription for prismatic (continuous solid with pores)

- Tanaka and Chisaka expression for effective radial conductivity (of a single PMR hex block)

$$k_{eff} = k_s \left[A + (1 - A) \frac{\ln(1 + 2B(k_{por} / k_s - 1))}{2B(1 - k_s / k_{por})} \right]$$

- A radiation term is incorporated in parallel with the pore conductivity
- Thermal resistance of helium gaps between hex block fuel elements is added in parallel via a gap conductance term

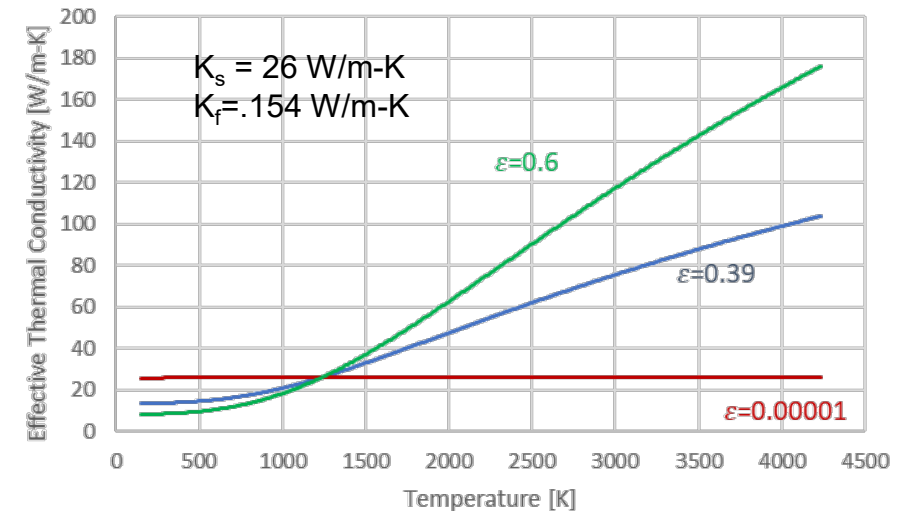
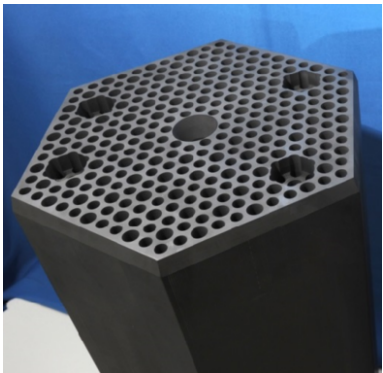

Interface Between Thermal-hydraulics and Pebble Bed Reactor Core Structures

Heat transfer coefficient (Nusselt number) correlations for pebble bed convection:

- Isolated, spherical particles
- Use T_{film} to evaluate non-dimensional numbers, use maximum of forced and free Nu

$$Nu_{Free} = 2.0 + 0.6 Gr_f^{1/4} Pr_f^{1/3} \qquad Nu_{Forced} = 2.0 + 0.6 Re_f^{1/2} Pr_f^{1/3}$$

- Constants and exponents accessible by sensitivity coefficient

Flow resistance

- Packed bed pressure drop

$$K_L(\epsilon, Re) = \left[C_1 + C_2 \frac{1-\epsilon}{Re} + C_3 \left(\frac{1-\epsilon}{Re} \right)^{C_4} \right] \frac{(1-\epsilon)L}{\epsilon D_p}$$

Correlation	C ₁	C ₂	C ₃	C ₄
Ergun (original)	3.5	300.	0.0	-
Modified Ergun (smooth)	3.6	360.	0.0	-
Modified Ergun (rough)	8.0	360.	0.0	-
Achenbach	1.75	320.	20.0	0.4

