

# Non-LWR Fuel Cycle Scenarios for SCALE and MELCOR Modeling Capability Demonstration



Friederike Bostelmann, ORNL  
Eva E. Davidson, ORNL  
William A. Wieselquist, ORNL

David Luxat, SNL  
Kenneth C. Wagner, SNL  
Lucas I. Albright, SNL

**Approved for public release.  
Distribution is unlimited.**

**December 15, 2023**



#### DOCUMENT AVAILABILITY

Reports produced after January 1, 1996, are generally available free via US Department of Energy (DOE) SciTech Connect.

**Website** [osti.gov](http://osti.gov)

Reports produced before January 1, 1996, may be purchased by members of the public from the following source:

National Technical Information Service  
5285 Port Royal Road  
Springfield, VA 22161  
**Telephone** 703-605-6000 (1-800-553-6847)  
**TDD** 703-487-4639  
**Fax** 703-605-6900  
**E-mail** [info@ntis.gov](mailto:info@ntis.gov)  
**Website** [classic.ntis.gov](http://classic.ntis.gov)

Reports are available to DOE employees, DOE contractors, Energy Technology Data Exchange representatives, and International Nuclear Information System representatives from the following source:

Office of Scientific and Technical Information  
PO Box 62  
Oak Ridge, TN 37831  
**Telephone** 865-576-8401  
**Fax** 865-576-5728  
**E-mail** [reports@osti.gov](mailto:reports@osti.gov)  
**Website** [osti.gov](http://osti.gov)

This report was prepared as an account of work sponsored by an agency of the United States Government. Neither the United States Government nor any agency thereof, nor any of their employees, makes any warranty, express or implied, or assumes any legal liability or responsibility for the accuracy, completeness, or usefulness of any information, apparatus, product, or process disclosed, or represents that its use would not infringe privately owned rights. Reference herein to any specific commercial product, process, or service by trade name, trademark, manufacturer, or otherwise, does not necessarily constitute or imply its endorsement, recommendation, or favoring by the United States Government or any agency thereof. The views and opinions of authors expressed herein do not necessarily state or reflect those of the United States Government or any agency thereof.

Nuclear Energy and Fuel Cycle Division

**NON-LWR FUEL CYCLE SCENARIOS  
FOR SCALE AND MELCOR MODELING  
CAPABILITY DEMONSTRATION**

Friederike Bostelmann, ORNL

Eva E. Davidson, ORNL

William A. Wieselquist, ORNL

David Luxat, SNL

Kenneth C. Wagner, SNL

Lucas I. Albright, SNL

Date Published: December 15, 2023

Prepared by  
OAK RIDGE NATIONAL LABORATORY  
Oak Ridge, TN 37831-6283  
managed by  
UT-Battelle, LLC  
for the  
US DEPARTMENT OF ENERGY  
under contract DE-AC05-00OR22725

# CONTENTS

ABBREVIATIONS . . . . .	viii
ABSTRACT . . . . .	1
1. INTRODUCTION . . . . .	3
1.1 References . . . . .	5
2. UF <sub>6</sub> CONVERSION AND ENRICHMENT . . . . .	7
2.1 Conversion . . . . .	7
2.1.1 Reduction . . . . .	7
2.1.2 Hydrofluorination . . . . .	8
2.1.3 Fluorination . . . . .	8
2.1.4 Distillation and Packaging . . . . .	9
2.1.5 Uranium Recovery . . . . .	9
2.1.6 Inventory of Hazardous Material . . . . .	10
2.2 Enrichment . . . . .	10
2.3 Conversion Accident Scenarios . . . . .	10
2.4 Enrichment Accident Scenarios . . . . .	12
2.5 References . . . . .	12
3. SPENT FUEL REPROCESSING . . . . .	13
3.1 Overview of Advanced Fuel Cycles and Reprocessing . . . . .	13
3.1.1 Advanced Fuel Cycles . . . . .	13
3.1.2 Reprocessing Operations . . . . .	15
3.2 Separation Processes . . . . .	15
3.2.1 Aqueous Separation Processes . . . . .	16
3.2.2 Nonaqueous Separation Processes . . . . .	17
3.3 Accident Scenarios . . . . .	17
3.4 References . . . . .	19
4. FUEL FABRICATION/SYNTHESIS . . . . .	20
4.1 TRISO Fuel Particle Fabrication . . . . .	20
4.2 Fuel Pebble Fabrication . . . . .	22
4.3 Fuel Salt Synthesis . . . . .	23
4.3.1 Fluoride Salt . . . . .	23
4.3.2 Chloride Salt . . . . .	25
4.3.3 Accident Scenarios for Production from Fresh Fuel . . . . .	26
4.3.4 Accident Scenarios for Production from Spent Fuel . . . . .	27
4.4 Metallic SFR/HPR Fuel Fabrication . . . . .	28
4.5 Metallic SFR Fuel Assembly Fabrication . . . . .	30
4.6 Metallic HPR Fuel Assembly Fabrication . . . . .	32
4.7 References . . . . .	33
5. TRANSPORTATION . . . . .	35
5.1 UF <sub>6</sub> Transportation . . . . .	35
5.2 Fuel Pebble Transportation . . . . .	36
5.3 Transportation of Fuel Salt . . . . .	37
5.4 SFR Fuel Assembly Transportation . . . . .	39
5.5 HPR Fuel Assembly Transportation . . . . .	40
5.6 References . . . . .	41
6. HIGH TEMPERATURE GAS-COOLED REACTOR . . . . .	44
6.1 Plant and Operation Description . . . . .	45



6.2	Accident Scenarios . . . . .	45
6.2.1	Fresh Fuel Pebble Staging and Loading . . . . .	45
6.2.2	Power Production . . . . .	46
6.2.3	On-Site Dry Cask Storage . . . . .	47
6.3	References . . . . .	50
7.	<b>MOLTEN SALT-FUELED REACTOR . . . . .</b>	<b>52</b>
7.1	Plant and Operation Description . . . . .	52
7.2	Fuel Salt Conditioning, Mixing, and Loading . . . . .	53
7.3	Power Production with Online Chemical Processing . . . . .	54
7.4	On-site Storage of Discharged Waste Forms . . . . .	56
7.5	Accident Scenarios . . . . .	56
7.5.1	Fuel Salt Conditioning, Mixing, and Loading . . . . .	56
7.5.2	Power Production with Online Chemical Processing . . . . .	57
7.5.3	On-Site Storage of Discharged Waste Forms . . . . .	59
7.6	References . . . . .	60
8.	<b>FLUORIDE-SALT COOLED HIGH TEMPERATURE REACTOR . . . . .</b>	<b>61</b>
8.1	Plant and Operation Description . . . . .	61
8.1.1	Pebble Handling and Storage System . . . . .	62
8.1.2	Tritium Management . . . . .	65
8.1.3	Beryllium Control and Salt Activation . . . . .	65
8.2	Accident Scenarios . . . . .	66
8.2.1	Fresh Fuel Pebble Staging and Loading . . . . .	66
8.2.2	Power Production . . . . .	67
8.2.3	On-Site Dry Cask Storage . . . . .	68
8.3	References . . . . .	69
9.	<b>SODIUM-COOLED FAST REACTOR . . . . .</b>	<b>70</b>
9.1	Plant and Operation Description . . . . .	70
9.2	Fuel Handling System . . . . .	74
9.3	Accident Scenarios . . . . .	77
9.3.1	Fuel Staging and Loading / Power Production / Shuffle Operations . . . . .	77
9.3.2	On-site Dry Cask Storage . . . . .	78
9.4	References . . . . .	78
10.	<b>HEAT PIPE REACTOR . . . . .</b>	<b>79</b>
10.1	Plant and Operation Description . . . . .	79
10.2	Accident Scenarios . . . . .	81
10.2.1	Fresh Fuel Staging and Loading . . . . .	81
10.2.2	Power Production . . . . .	81
10.2.3	On-Site Dry Cask Storage . . . . .	82
10.3	References . . . . .	82
11.	<b>CONCLUSIONS . . . . .</b>	<b>83</b>
A.	<b>METHODOLOGIES FOR HAZARD CONSEQUENCE ANALYSIS WITH MELCOR . . . . .</b>	<b>A-1</b>
A.1	Context for non-LWR Facility Safety Modeling . . . . .	A-2
A.2	Accident Scenario Classes . . . . .	A-2
A.2.1	Criticality Event . . . . .	A-3
A.2.2	Explosion . . . . .	A-3
A.2.3	Fire . . . . .	A-4
A.2.4	Spills or Material Drops . . . . .	A-4
A.3	MELCOR Application . . . . .	A-5

A.4	Relevant MELCOR Phenomenological Models . . . . .	A-7
A.4.1	Aerosol Modeling . . . . .	A-7
A.4.2	Counter-current Flow Model . . . . .	A-8
A.4.3	Filters . . . . .	A-9
A.4.4	Sprays . . . . .	A-9
A.4.5	Radiation Enclosure Model . . . . .	A-10
A.5	References . . . . .	A-10
B.	<b>SCALE METHODS FOR CRITICALITY, INVENTORY, AND SHIELDING . . . . .</b>	<b>B-1</b>
B.1	Criticality . . . . .	B-2
B.2	Inventory Generation . . . . .	B-2
B.2.1	TRITON . . . . .	B-2
B.2.2	ORIGEN . . . . .	B-3
B.2.3	ORIGAMI . . . . .	B-3
B.3	Shielding . . . . .	B-3
B.4	References . . . . .	B-4

## LIST OF FIGURES

1	Non-LWR nuclear fuel cycle. . . . .	4
2	Non-LWR nuclear fuel cycle based on reprocessed fuel. . . . .	5
3	Electrometallurgical treatment process used for metallic fuel from the EBR-II . . . . .	18
4	Schematic of the electrometallurgical treatment used for metallic fuel from the EBR-II . . . . .	18
5	Illustration of TRISO Fabrication Process . . . . .	20
6	Schematic of TRISO Pebble or Compact Fabrication Process . . . . .	22
7	Schematic of Fuel Salt Fabrication Process . . . . .	23
8	Illustration of UF <sub>4</sub> Reduction Process . . . . .	28
9	Illustration of UO <sub>2</sub> Reduction Process . . . . .	29
10	Schematic illustration of SFR metallic fuel fabrication process . . . . .	31
11	Schematic illustration of EBR-II metallic fuel assembly . . . . .	32
12	DN30 package for UF <sub>6</sub> transportation . . . . .	36
13	Versa-Pac transportation canister . . . . .	38
14	ES-3100 Type B shipping container . . . . .	40
15	NAC-LWT shipping container . . . . .	41
16	Schematic of the PBMR-400 reactor core . . . . .	44
17	PBMR-400 FHSS piping showing six ribs . . . . .	48
18	PBMR-400 spent fuel storage tanks as part of the fuel handling and storage system . . . . .	48
19	PBMR-400 spent fuel storage tank . . . . .	49
20	Thermal spectrum MSR . . . . .	53
21	Off-gas system in an MSR . . . . .	55
22	MSR waste salt processing and immobilization . . . . .	56
23	The UCB PB-FHR reactor vessel . . . . .	61
24	UCB PB-FHR flow schematic . . . . .	63
25	Simplified process flow diagram for the PHSS under normal operation . . . . .	63
26	Pebble injection channels schematic . . . . .	64
27	Schematic figure of hot-salt manifold pipe . . . . .	66
28	ABTR primary system . . . . .	72
29	ABTR core layout . . . . .	73
30	Fuel handling system in an ABTR . . . . .	73
31	Rotatable plug in the ABTR . . . . .	74
32	Pantograph fuel handling machine in the ABTR . . . . .	75
33	ABTR fuel storage rack . . . . .	75
34	ABTR fuel unloading machine . . . . .	76
35	INL Design A core . . . . .	80
36	INL Design A fuel element . . . . .	80
37	Fire scenario progression . . . . .	A-4
38	Fire scenario progression . . . . .	A-9

**LIST OF TABLES**

1 **Comparison of LWR and Non-LWR basic design characteristics . . . . . 3**

2 Versa-Pac maximum <sup>235</sup>U per package . . . . . 37

3 MELCOR modeling of relevant processes during facility accidents . . . . . A-6

## ABBREVIATIONS

ABTR	Advanced Burner Test Reactor
ANSI	American National Standards Institute
ARP	automated rapid processing
BUMS	burnup measurement and sorting system
BWR	boiling water reactor
CADIS	Consistent Adjoint Driven Importance Sampling
CCS	criticality control system
CE	continuous-energy
COEX	Co-Extraction of Uranium and Plutonium
CSAS	Criticality Safety Analysis Sequence
CTAH	coiled tube air heater
CUD	core unloading device
CVH/FL	control volume hydrodynamic and flow path model
DIAMEX	Diamide Extraction
DOE	US Department of Energy
DRACS	direct reactor auxiliary cooling system
EBR-I	Experimental Breeder Reactor I
EBR-II	Experimental Breeder Reactor II
EFPD	effective full-power day
EMT	Electrometallurgical Treatment
EXAm	Extraction of Americium
FHR	fluoride salt-cooled high-temperature reactor
FHSS	fuel handling and storage system
FUM	fuel unloading machine
FW-CADIS	Forward-Weighted-CADIS
GANEX	Grouped Actinide Extraction
HALEU	high-assay low-enriched uranium
HMTA	hexamethylenetetramine
HPR	heat pipe reactor
HTGR	high-temperature gas-cooled reactor
I&C	instrumentation & control
IBC	inter-building cask
IHX	intermediate heat exchangers
IMSR	Integral Molten Salt Reactor
LANL	Los Alamos National Laboratory
LEU	low-enriched uranium
LWR	light-water reactor
MAVRIC	Monaco with Automated Variance Reduction using Importance Calculations
MCFR	Molten Chloride Fast Reactor
MCRE	Molten Chloride Reactor Experiment
MG	multigroup
MOX	mixed oxide fuel
MSBR	Molten Salt Breeder Reactor
MSR	molten salt-fueled reactor

MSRE	Molten Salt Reactor Experiment
MTS	methyltrichlorosilane
NAAC	Nuclear Air - Brayton Cycle
NEF	National Enrichment Facility
NEXT	New Extraction System for TRU Recovery
NRC	US Nuclear Regulatory Commission
ORIGEN	Oak Ridge Isotope Generation code
ORNL	Oak Ridge National Laboratory
PBR	pebble-bed reactor
PCTS	pebble canister transfer system
PCUD	pebble canister unloading device
PFHM	pantograph fuel handling machine
PHSS	pebble handling and storage system
PRA	probabilistic risk assessment
PSP	protective structural packaging
PUREX	Plutonium Uranium Reduction Extraction
PWR	pressurized water reactor
RN	Radionuclide
SANEX	Selective Actinide Extraction
SER	safety evaluation report
SFR	sodium-cooled fast reactor
SNL	Sandia National Laboratories
SPR	spray
SSC	structure, system or component
TALSPEAK	Trivalent Actinide Lanthanide Separation with Phosphorus-Reagent Extraction from Aqueous Komplexes
TCE	trichloroethane
TRISO	tristructural isotropic
TRUEX	Transuranium Extraction
UREX	Uranium Recovery by Extraction



## **ACKNOWLEDGMENTS**

Support for this work was provided by the US Nuclear Regulatory Commission (NRC) under Contract IAA 31310022S0011 (Oak Ridge National Laboratory) and IAA 31310022F0014 (Sandia National Laboratories). The authors would like to thank Drew Barto, Shawn Campbell, and Lucas Kyriazidis of the NRC for their support and constructive feedback. The development of representative non-LWR fuel cycles greatly benefited from discussions with members of the NRC's Office of Nuclear Material Safety and Safeguards and the NRC's Office of Nuclear Regulatory Research.

## ABSTRACT

To assess the modeling and simulation capabilities for radionuclide characterization, criticality, and shielding in the nuclear fuel cycle of non-light-water reactor (LWR) technologies, the US Nuclear Regulatory Commission (NRC) initiated a collaborative project between the NRC, Sandia National Laboratories (SNL), and Oak Ridge National Laboratory (ORNL) with the goal to demonstrate capabilities of MELCOR and SCALE to calculate accident scenarios in all stages of the nuclear fuel cycle for relevant non-LWRs. The first project task was to develop representative nuclear fuel cycles and identify potential hazards and accident scenarios in the individual fuel cycle stages based on publicly available information. Because the nuclear fuel cycle is not established for any non-LWR concept, many assumptions were made, and it is anticipated that the details of the fuel cycles will eventually look different.

Representative nuclear fuel cycles were developed for the pebble-bed high-temperature gas-cooled reactor (HTGR), the molten salt-fueled reactor (MSR), the pebble-bed fluoride salt-cooled high temperature reactor (FHR), the sodium-cooled fast reactor (SFR), and the heat pipe reactor (HPR). Publicly available specifications of representative reactor concepts served as basis for these fuel cycles. The discussion of each fuel cycle stage includes major occurring hazards, and a list of developed potential accident scenarios that is independent of the probability of these accidents to occur. Many of the fuel cycles have overlapping hazards and accident scenarios based on their coolant materials, fuel types, their shared need of UF<sub>6</sub> enrichment, transportation of UF<sub>6</sub>, and specific fuel type.

The list of accident scenarios developed here is intended to be used in the next project phase. A number of scenarios from the developed lists will be selected for modeling and simulation with SCALE and MELCOR to assess computational models and capabilities as well as to demonstrate the analysis of these scenarios. The SNL team will further develop and apply MELCOR to perform severe accident progression and source term analyses for the selected accident scenarios. The ORNL team will use SCALE to provide MELCOR with data such as the nuclide inventories and decay heat and will conduct further analyses, including criticality and radiation shielding analyses.

## 1. INTRODUCTION

To assess modeling and simulation capabilities for accident progression, source term, and consequence analysis for non-light-water reactor (LWR) technologies, the US Nuclear Regulatory Commission (NRC) initiated a collaborative project between the NRC, Sandia National Laboratories (SNL), and Oak Ridge National Laboratory (ORNL) which is detailed in “Volume 5: Radionuclide Characterization, Criticality, Shielding and Transport in the Nuclear Fuel Cycle” [5]. This project is intended to demonstrate the capabilities of the MELCOR [2] and SCALE [7] codes to calculate accident scenarios in all stages of the nuclear fuel cycle for relevant non-LWRs. Within this project, the SNL team will continue to develop and use MELCOR to perform severe accident progression and source term analyses for selected accident scenarios in the nuclear fuel cycles of various non-LWRs. The ORNL team will use SCALE to provide MELCOR with data such as nuclide inventories and decay heat and will perform further analyses, including criticality and radiation shielding analyses. Volume 5 follows efforts recently concluded as described in “Volume 3: Computer Code Development Plans for Severe Accident Progression, Source Term, and Consequence Analysis” [4]. In the Volume 3 effort, the use of MELCOR and SCALE was demonstrated for calculation of accident scenarios during operation of various non-LWRs. The non-LWR fuel cycles analyzed in Volume 5 were selected based on recently renewed industry interest in the United States to develop and deploy various non-LWR concepts [6].

The first task for this Volume 5 project was to develop representative nuclear fuel cycles for five non-LWR designs and to identify potential hazards and accident scenarios in the individual fuel cycle stages. The non-LWR concepts for which representative nuclear fuel cycles were developed are (1) the pebble-bed high-temperature gas-cooled reactor (HTGR), (2) the molten salt–fueled reactor (MSR), (3) the pebble-bed fluoride salt–cooled high-temperature reactor (FHR), (4) the sodium-cooled fast reactor (SFR), and (5) the heat pipe reactor (HPR). Table 1 lists major design characteristics of these non-LWR in comparison with a pressurized water reactor (PWR), and the individual Sections in this report discuss further design details.

All information used to develop these representative nuclear fuel cycles was taken from publicly available information. Given that the nuclear fuel cycle is not yet established for any of the non-LWR concepts discussed here, many assumptions were made based on limited information. It is anticipated that the details of the fuel cycles will change. In the next project phase, specific scenarios will be selected for modeling and simulation efforts with SCALE and MELCOR to assess and demonstrate their capabilities for the analysis of these scenarios and to identify potential data gaps. Relevant MELCOR and SCALE methods are discussed briefly in Appendixes A and B, respectively.

**Table 1. Comparison of LWR and Non-LWR basic design characteristics**

	PWR	Pebble-bed HTGR	HPR	Pebble-bed FHR	MSR	SFR
Fuel Form	Fuel rod	TRISO particles <sup>a</sup>	Fuel rod	TRISO particles <sup>a</sup>	Salt	Fuel rod
Fuel Type	LEU	HALEU	HALEU	HALEU	HALEU	HALEU or U/TRU
Coolant	H <sub>2</sub> O	He (gas)	K or Na (liq.)	Flibe salt	Li or Cl salt	Na (liq.)
Primary Moderator	<sup>1</sup> H	Graphite	—	Graphite	Graphite/—	—
Neutron Energy Spectrum	thermal	thermal	fast	thermal	thermal/fast	fast
Discharge Burnup (GWd/MTU)	45-60	90-120	2	up to 180.0	continuous	100

*Note:* The above listed characteristics are based on concepts available in the public literature and serve here to highlight major differences between the reactor concepts. Characteristics of new advanced reactor designs may differ.

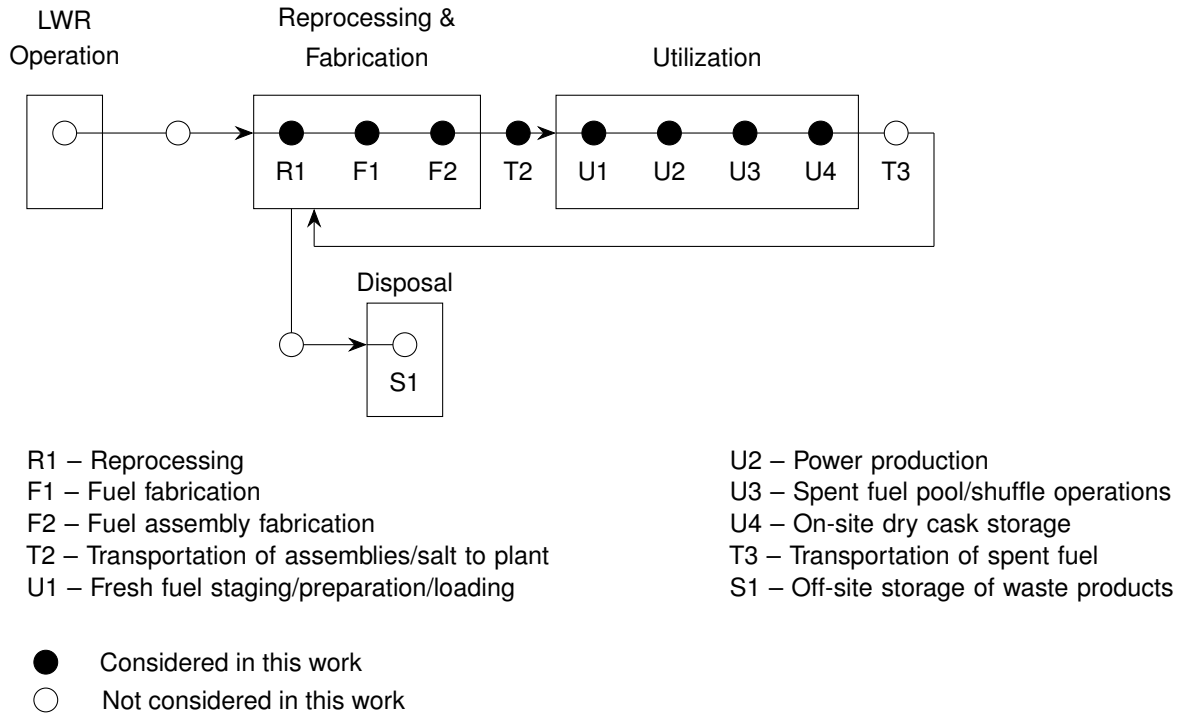
<sup>a</sup> TRISO particles in fuel pebbles

Nuclear fuel cycles can be defined in terms of the following classes with respect to the management of Pu [1]:

- An *open fuel cycle* in which Pu from spent fuel is intended to be sent to a geologic repository for permanent disposal



because of large uncertainties associated with this stage. Although the enrichment stage is in principle similar to that of the LWR fuel cycle, most of the non-LWRs that are pursued in the United States and intend to operate with uranium fuels have enrichments up to 19.75 wt% (high-assay low-enriched uranium (HALEU)) [3], whereas LWRs traditionally use low-enriched uranium (LEU) fuel with up to 5 wt% enrichment. A closed fuel cycle with the relevant stages for spent fuel reprocessing is displayed in Figure 2.



**Figure 2. Non-LWR nuclear fuel cycle based on reprocessed fuel.**

The representative nuclear fuel cycles were developed and accident scenarios were identified through a thorough literature study and discussions among the NRC and the ORNL and SNL teams. Along with research articles discussing reactor designs and hazards, some of the most useful resources were documents detailing phenomena identification and ranking tables for specific reactor concepts, articles detailing operating experience, safety analysis reports for specific containers or components, regulatory documents, and benchmark specifications.

This report presents the developed nuclear fuel cycles with all conceivable accident scenarios independently of their probability to occur. This includes beyond design basis accidents. Non-LWR concepts with overlapping stages are discussed together. All considered non-LWR designs rely on  $UF_6$  enrichment (Chapter 2). Reprocessing of spent LWR fuel for use in fast spectrum reactors is discussed in Chapter 3. Fuel fabrication (or synthesis in the case of MSR) is discussed in Chapter 4 because both the HTGR and the FHR rely on fabrication of TRISO fuel particles and fuel pebbles, and both the SFR and HPR rely on fabrication of metallic fuel rods. Some of the non-LWRs share similar fuel transportation conditions, so these are discussed in Chapter 5. The utilization stages are discussed in Chapters 6 through 10, with each of the five selected non-LWR designs being discussed in a separate chapter.

## 1.1 REFERENCES

- [1] *Advanced Nuclear Fuel Cycles - Main Challenges and Strategic Choices*. Technical Report 1020307, Electric Power Research Institute, Palo Alto, CA, 2010. URL: <https://www.epri.com/research/>

products/1020307.

- [2] L. L. Humphries, B. A. Beeny, F. Gelbard, D. L. Louie, J. Phillips, R. C. Schmidt, and N. E. Bixler. *MELCOR Computer Code Manuals Vol. 1: Primer and Users' Guide Version 2.2.18019*. Technical Report SAND2021-0726 O, Sandia National Laboratories, Albuquerque, NM, 2021. URL: <https://www.nrc.gov/docs/ML2104/ML21042B319.pdf>.
- [3] NEI. *Establishing a High Assay Low Enriched Uranium Infrastructure for Advanced Reactors* (White Paper). Technical report, Nuclear Energy Institute, Washington, D.C., 2022. URL: <https://www.nei.org/CorporateSite/media/filefolder/resources/reports-and-briefs/NEI-White-Paper-Establishing-a-High-Assay-Low-Enriched-Uranium-Infrastructure-for-Advanced-Reactors-Jan-2022.pdf>.
- [4] US NRC. *NRC Non-Light Water Reactor (Non-LWR) Vision and Strategy, Volume 3: Computer Code Development Plans for Severe Accident Progression, Source Term, and Consequence Analysis*. Technical Report ML20030A178, Rev. 1, US Nuclear Regulatory Commission, Rockville, MD, 2020. URL: <https://www.nrc.gov/docs/ML2003/ML20030A178.pdf>.
- [5] US NRC. *NRC Non-Light Water Reactor (Non-LWR) Vision and Strategy, Volume 5: Radionuclide Characterization, Criticality, Shielding and Transport in the Nuclear Fuel Cycle*. Technical Report ML21088A047, Rev. 1, US Nuclear Regulatory Commission, Rockville, MD, 2021. URL: <https://www.nrc.gov/docs/ML2108/ML21088A047.pdf>.
- [6] US NRC. Pre-Application Activities for Advanced Reactors. <https://www.nrc.gov/reactors/new-reactors/advanced/licensing-activities/pre-application-activities.html>, 2022. Accessed: 2022-09-07.
- [7] W. A. Wieselquist and R. A. Lefebvre (Eds.). *SCALE 6.3.1 User Manual*. Technical Report ORNL/TM-SCALE-6.3.1, Oak Ridge National Laboratory, Oak Ridge, TN, 2023.



## 2. UF<sub>6</sub> CONVERSION AND ENRICHMENT

The UF<sub>6</sub> enrichment phase (E1) of the non-LWR fuel cycle is treated as a common phase across all the different reactor concept fuel cycles. As with all phases of the non-LWR fuel cycle, this process phase is being defined to specify—at the appropriate level of generality—the key processes giving rise to hazards relevant to the evaluation of safety. There are two classes of scenarios relevant to the assessment of code capabilities:

- Scenarios defining measures that prevent the realization of a hazard
- Scenarios in which a hazard leads to release of material that, if not mitigated, could result in harm to workers, the public, or the environment

Scenarios identified to demonstrate prevention of a hazard may not require further evaluation to establish consequences should the hazard be realized. For example, evaluations for criticality accidents focus on establishing the effectiveness of measures and engineered or administrative controls to prevent unintended occurrence.

UF<sub>6</sub> enrichment (or conversion) facilities have been previously assessed in the United States and relevant analyses are documented in NUREG/CR-6410 [2]. However, these results relied on legacy tools which make it difficult to reproduce the results and that do not reflect the state-of-the-art capabilities in the SCALE and MELCOR codes available for neutronic and hazard consequence assessments. However, the overall scope of capability needs are well characterized in NUREG/CR-6410 and form the basis for accident scenario definition.

The overall UF<sub>6</sub> enrichment process has the following stages:

- Conversion that processes U<sub>3</sub>O<sub>8</sub> (“yellow cake”) into uranium hexafluoride (UF<sub>6</sub>)
- Enrichment in which UF<sub>6</sub> is enriched to higher concentrations of <sup>235</sup>U within UF<sub>6</sub>

For the purposes of this capability demonstration, it is assumed that UF<sub>6</sub> conversion and enrichment occur in a common facility. While alternate methods for uranium enrichment exist, such as gaseous diffusion and atomic vapor laser isotope separation (AVLIS), only gas centrifuges are considered here. After final enrichment, the enriched UF<sub>6</sub> is transported to the fuel fabrication facility. The transportation stage (T1) is discussed further in Chapter 5.

### 2.1 CONVERSION

The process of conversion from U<sub>3</sub>O<sub>8</sub> to UF<sub>6</sub> includes several steps as discussed in this subsection. This stage is defined based on information provided in NUREG/CR-6410 [2].

#### 2.1.1 REDUCTION

According to NUREG/CR-6410 [2], fluidized bed reactors are used to reduce triuranium octoxide (U<sub>3</sub>O<sub>8</sub>) to uranium dioxide (UO<sub>2</sub>). The fluidizing gas consists of hydrogen gas (H<sub>2</sub>) and nitrogen gas (N<sub>2</sub>) forms from the dissociation of ammonia (NH<sub>3</sub>) via the following process:

- A steam source is used to vaporize NH<sub>3</sub>.
- Vaporized NH<sub>3</sub> is fed to dissociators at high temperatures
- In the dissociators, high temperature and a catalyst are used to separate the NH<sub>3</sub> gas into its elemental components

U<sub>3</sub>O<sub>8</sub> is reduced using the stream of hydrogen from the dissociation process as shown in the following chemical reaction:



The off-gas stream produced at the reduction step consists of nitrogen, water vapor, hydrogen, and hydrogen sulfide. These off-gases are filtered to remove any particulate uranium.

### 2.1.2 HYDROFLUORINATION

The reduction step produces UO<sub>2</sub> that is fed into a hydrofluorination step that produces uranium tetrafluoride (UF<sub>4</sub>). This step has the following stages based on NUREG/CR-6410 [2]:

- Hydrofluoric acid (HF), which is stored on-site as a liquid, is transformed into a gaseous form through a system of vaporizers and heat exchangers at a temperature necessary to support the desired reaction
- The HF is then used as a fluidizing gas which is introduced as a counter-current flow into the reactor to interact with the input UO<sub>2</sub> from the reduction step

The hydrofluorination reaction occurring in the fluidized-bed reactor is



Off-gases from this reaction are filtered to remove particulate uranium. A water and potassium hydroxide (KOH) solution is used to remove HF. Further treatment of the scrubber liquids is performed to remove fluoride. Water fluoride can be treated to create calcium fluoride (CaF<sub>2</sub>). Remaining gases after this treatment can be vented to the environment.

### 2.1.3 FLUORINATION

The resulting UF<sub>4</sub> is subsequently passed into a fluidized-bed fluorinator to produce the desired UF<sub>6</sub> conversion product. The solid UF<sub>4</sub> is introduced into a fluidized-bed fluorinator that also consists of a bed of inert material. The fluidizing gas, elemental F<sub>2</sub>, reacts with solid UF<sub>4</sub> to produce gaseous UF<sub>6</sub> according to the following chemical reaction:



After the reaction, the bed material contains some residual uranium and nonvolatile uranium daughter products. It can be reused a number of times, until the build-up of these residual contaminants becomes too great. Upon retirement, the bed material is allowed to undergo radioactive decay and uranium content is recovered.

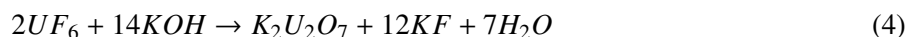
Gas containing UF<sub>6</sub> is further processed to collect a pure stream of UF<sub>6</sub>. The off-gas at this stage consists of UF<sub>6</sub>, as well as excess F<sub>2</sub> and HF. The gas is passed through a series of filters and cold traps to remove particulates and UF<sub>6</sub>.

The condensation of UF<sub>6</sub> is achieved through a series of cold traps:

- Primary cold traps are operated at approximately 266 K, removing the bulk of the UF<sub>6</sub>
- Remaining UF<sub>6</sub> is removed using secondary and tertiary cold traps operating at lower temperatures

The crude UF<sub>6</sub> is intermittently removed from the cold traps by liquefaction before being passed into the subsequent distillation step (see below).

The crude UF<sub>6</sub> collected in cold traps at the end of the fluorination step is accompanied by off-gases. These include fluorine, air, and traces of UF<sub>6</sub>. Scrubbers are used to remove fluorides and traces of uranium prior to any release to the environment. The scrubbing solution consists of KOH and follows the chemical reaction



The products of this chemical reaction are further treated:

- K<sub>2</sub>U<sub>2</sub>O<sub>7</sub> precipitated in the off-gas scrubbers is settled out of the KOH solution
- Soluble fluorides are washed out of the KOH solution

The processed KOH solution is then recycled.

#### 2.1.4 DISTILLATION AND PACKAGING

Cold traps in the fluorination stage collect *crude* UF<sub>6</sub> in solid form. It must be subsequently liquefied and distilled to remove impurities before ultimately being packaged. The distillation process follows the following steps:

- UF<sub>6</sub> is liquefied from the collection cold traps before being transported to a distillation column feed tank
- Liquid UF<sub>6</sub> is fed from the feed tank into a series of distillation columns
- A low boiler distillation column is used first to remove low-boiling-point impurities
- A high boiler distillation column then receives this stream of UF<sub>6</sub> to remove high-boiling-point impurities
- The high purity output from the high boiler distillation column is condensed and packaged into approved cylinders

#### 2.1.5 URANIUM RECOVERY

The following components/materials that are used in the overall process may become contaminated with uranium:

- Fluorinator filter lines
- Contaminated fluorinator bed material
- Recovered dust
- Scrap materials

In addition, UF<sub>6</sub> product cylinders may also accumulate uranium residues. Leaching liquids are used to recover residual uranium from packaging cylinders. This stream is also subject to uranium recovery.

These streams of material that contain uranium are recycled to a uranium mill for recovery.

### 2.1.6 INVENTORY OF HAZARDOUS MATERIAL

Hazardous material is used or produced in these processing operations. As specified in NUREG/CR-6410 [2], these materials can be categorized as hazardous chemical and radiological materials.

The inventory of hazardous chemical materials includes the following:

- Ammonia (NH<sub>3</sub>)
- Fluorine gas (F<sub>2</sub>)
- Hydrofluoric acid (HF)
- Potassium hydroxide (KOH)
- Uranium tetrafluoride (UF<sub>4</sub>)
- Uranium hexafluoride (UF<sub>6</sub>)
- Sulfuric acid (H<sub>2</sub>SO<sub>4</sub>)

Radiological materials include the following:

- Uranium dioxide (UO<sub>2</sub>)
- Uranium tetrafluoride (UF<sub>4</sub>)
- Uranium hexafluoride (UF<sub>6</sub>)

### 2.2 ENRICHMENT

Enrichment of UF<sub>6</sub> is achieved using a gas centrifuge process:

- Feed of UF<sub>6</sub> is volatilized
- Volatilized UF<sub>6</sub> is passed through a cascade of separation centrifuges
- Enriched UF<sub>6</sub> is condensed into product cylinders, and depleted UF<sub>6</sub> is stored in tails cylinders

The following hazardous materials are typically present during gas centrifuge enrichment:

- UF<sub>6</sub> present in the solid and liquid state
- Halogenated organic refrigerants
- Fuel oil stored for heating

For the traditional LWR fuel cycle, enrichments up to 5 wt% <sup>235</sup>U are considered. The non-LWR fuel cycles require enrichments up to 19.75 wt% <sup>235</sup>U (HALEU).

### 2.3 CONVERSION ACCIDENT SCENARIOS

In liquid and gaseous forms, UF<sub>6</sub> is the only source of *dispersible* radiological material throughout the conversion stage of enrichment. It accumulates or is stored in a number of process vessels:

- UF<sub>6</sub> vaporizer
- UF<sub>6</sub> cylinder fill
- Fluorinator
- Condenser

- Fluorination filter
- Still feed tank
- Cold trap

Scenarios that could result in a release of radioactive material are those associated with UF<sub>6</sub> processing or storage. These scenarios are identified in NUREG/CR-6410 [2].

- E1.1: UF<sub>6</sub> cylinder overfilled and heated → UF<sub>6</sub> release upon rupture of storage cylinder
- E1.2: UF<sub>6</sub> cylinder dropped → UF<sub>6</sub> liquid and vapor leakage from damaged cylinder

In the cylinder rupture scenarios in E1.1 and E1.2, the release of UF<sub>6</sub> vapor from the cylinder is determined by the nature of the rupture. For catastrophic rupture events, a very fast rate of depressurization occurs. This leads to vaporization of a significant fraction of the UF<sub>6</sub>, as well as the potential for entrainment of solid UF<sub>6</sub> particulates in the released gas stream. For smaller ruptures, the vaporization and release of UF<sub>6</sub> will occur more slowly, governed by the much slower rate of depressurization of the system.

In addition to the radiological material release scenarios identified in NUREG/CR-6410, the National Enrichment Facility (NEF) safety evaluation report (SER) [1] identifies additional scenarios associated with both criticality and radiological release:

- E1.3: Earthquake causing pipe rupture → UF<sub>6</sub> release
- E1.4: Fire in the UF<sub>6</sub> handling hall → UF<sub>6</sub> release
- E1.5: Unintended accumulation of enriched U → inadvertent nuclear criticality

Scenarios could also arise when hazardous chemicals are released. These scenarios are summarized below for completeness, but they will not likely be the main focus of MELCOR and SCALE capability demonstration activities:

- HF release: hazards arise typically during the recovery and storage of this chemical. A failure of the recovery system has the potential to lead to an atmospheric release of HF. Failure of the storage system can also lead to release of HF.
- NH<sub>3</sub> release: hazards are associated with the use of NH<sub>3</sub> in reduction processes when it is dissociated into its elemental components. NH<sub>3</sub> exposure can lead to death or injury to skin, lungs, and eyes.
- Fluorine release: hazards arise as a result of the defluorination process. Fluorine is a skin irritant and is corrosive to all living tissue. It has effects similar to those of HF to the eyes. Overall, it can lead to death, severe burning, and destruction of human tissue. Because fluorine is usually stored under pressure, it can be released upon storage tank failure.

The nature of a chemical release varies, but it can typically be categorized into one of the following types of release scenarios:

- Catastrophic rupture of a storage cylinder leading to discharge of the stored inventory over a relatively short period of time.
- Rupture of a tank at elevated temperatures such that the material vapor pressure is above atmospheric, leading to flashing and discharge of the material. At high enough storage temperatures, flashing may lead to formation of liquid HF droplets that become airborne and are carried with the discharging vapor.
- Rupture of a tank at low temperatures such that the material vapor pressure is below atmospheric pressure, leading to the potential for hazardous liquid spilling to the ground to form a pool from which evaporation occurs. The rate of evaporation is typically governed by the pool surface area.

- When holes or cracks form in a storage tank wall, contained fluids can emerge in the form of a jet. The material release can be liquid, vapor, or a combination of liquid and vapor, depending on the location of the failure.

Because hydrogen enters during the UF<sub>6</sub> conversion process, a potential hydrogen hazard could arise if excess hydrogen is not burned off (e.g., with a pilot flame system). Accumulation of excess hydrogen inside vessels or enclosures can lead to fires, deflagrations, or detonations.

## 2.4 ENRICHMENT ACCIDENT SCENARIOS

Release of UF<sub>6</sub> to the facility's atmosphere or the environment is the primary hazard during the enrichment process. Material inventories passing through the centrifuge process are usually quite small. The primary source of appreciable UF<sub>6</sub> material release would be from failure of storage cylinders located in storage areas or process buildings. There could also be a release resulting from failure of piping that connects cylinders to various process operations. The types of release scenarios that could occur are captured by the scenarios defined in discussions of the conversion stage in Section 2.3. For criticality scenario E1.5, a UF<sub>6</sub> enrichment of up to 19.75% must be considered.

## 2.5 REFERENCES

- [1] *Safety Evaluation Report for the National Enrichment Facility in Lea County, New Mexico*. Technical Report NUREG-1827, US NRC, Washington, DC, 2005. URL: <https://www.nrc.gov/docs/ML0517/ML051780290.pdf>.
- [2] J. E. Ayer, A. T. Clark, P. Loysen, M. Y. Ballinger, J. Mishima, P. C. Owczarski, W. S. Gregory, and B. D. Nichols. *Nuclear Fuel Cycle Facility Accident Analysis Handbook*. Technical Report NUREG/CR-6410, Science Applications International Corporation, Washington, DC, 1998. URL: <https://www.nrc.gov/docs/ML0720/ML072000468.pdf>.



### 3. SPENT FUEL REPROCESSING

This chapter focuses on operations for reprocessing of spent fuel and the hazards relevant to safety that can arise. Reprocessing introduces new types of processing operations, resulting in separate streams of reusable fuel material and waste. An extensive review and evaluation of advanced fuel cycles that involve reprocessing of fuel was recently developed by the US National Academy of Sciences [1]. The subsequent discussion summarizes the salient points raised in this extensive report.

Although reprocessing of nuclear fuel is not currently implemented in the United States, it is covered in this work to allow demonstration of code readiness to evaluate operations required to realize closed fuel cycles. For the purposes of capability demonstration in this project, it is assumed that spent fuel reprocessing is used to supply fuel to an SFR. However, this assumption does not introduce any notable limitations in the overall code capability evaluation.

#### 3.1 OVERVIEW OF ADVANCED FUEL CYCLES AND REPROCESSING

##### 3.1.1 ADVANCED FUEL CYCLES

Reprocessing systems are required to support advances to the once-through fuel cycle. In the case of LWRs, these include:

- **Monorecycling of uranium and plutonium generated in LWRs.** This fuel cycle utilizes the Plutonium Uranium Reduction Extraction (PUREX) process for separation and is the only fuel cycle besides the once-through fuel cycle that has been commercially deployed for LWR operations (e.g., in France). The stream of uranium and plutonium generated by the PUREX process is recycled to fabricate reprocessed uranium and mixed oxide (UOX and MOX) fuel. Note that re-enrichment of reprocessed uranium is required, and some over-enrichment is often required to counteract the presence of neutron-absorbing uranium isotopes  $^{232}\text{U}$ ,  $^{234}\text{U}$ , and  $^{236}\text{U}$ . The plutonium can be mixed with depleted uranium to make MOX fuel that can be re-used in an LWR. MOX fuel generated from spent LWR fuel contains about 7–10 percent Pu which varies according to the Pu isotopic vector.
- **Multi-recycling of plutonium in LWRs.** This fuel cycle attempts to create a closed loop for plutonium. The plutonium extracted from spent fuel is in concept continually recycled in UOX and MOX fuels. The ultimate goal of this fuel cycle is to prevent any plutonium being sent to permanent geological storage.

Although these types of fuel cycles attempt to reduce the amount of uranium and plutonium sent to a long-term geological repository, they only partially address the need of long-term storage of spent nuclear fuel. If LWR fuel is directly deposited in a final repository after being discharged from a LWR, it takes more than 100,000 years until the radiotoxicity level drops below the reference value for uranium ore. The nuclides providing the largest contribution to the long-term radiological hazard are nuclides with atomic numbers higher than 92, the so called transuranic nuclides. In contrast, fission and activation products have shorter half-lives such that their radiotoxicity level is small already after a few hundred years. Studies have been conducted to identify the potential for transuranic radionuclides to be partitioned and transmuted as a means of significantly reducing the inventory requiring long-term disposition. The key element to achieve this is the *transmutation technology*. The US National Academy of Sciences [1] advanced fuel cycles study identifies the following examples of technology considered for transmutation of the minor actinides:

- Fast reactors (e.g., SFRs)

Fast neutrons predominant in fast spectrum reactors will promote fission and neutron production from all plutonium isotopes and other minor actinides. This typically results in a reduction of the inventory of minor actinides generated in a fast reactor. This is distinct from thermal reactors, in which minor actinides accumulate during operation.

- Thermal reactors (e.g., PWRs)

In a thermal reactor such as an LWR, the neutron capture reaction results in the buildup of large inventories of higher actinides including curium isotopes. These isotopes are strong neutron emitters. This has a negative effect on fuel reprocessing and fabrication operations (i.e., the neutron source term is about 2,000 times larger than for fuel discharged from a fast reactor). Thermal reactors are thus not practical technologies to achieve transmutation of the transuranics.

- Accelerator-driven systems

These systems consist of an accelerator and reactor. The accelerator generates a particle beam that is then focused on a subcritical target, resulting in generation of high-energy neutrons through the process of spallation. These high-energy neutrons are then directed to interact with a subcritical blanket assembly in which isotopes undergo fission promoting transmutation.

- Fusion/fission hybrids

This type of hybrid system is similar to an accelerator-driven system, with the exception that the high-energy beam of neutrons is generated by a fusion reactor.

Studies of accelerator-driven systems and fusion/fission hybrids are still largely conceptual; these systems will require much more significant technology maturation than a fast reactor. Because fast neutrons are important to achieve advanced fuel cycles that significantly reduce the inventory of transuranics requiring long-term disposal, as noted above, the scope of reprocessing operations are limited to those intended to use a fast reactor such as an SFR. These objectives are considered within the scope of this capability demonstration initiative.

Fast reactor technology in an advanced fuel cycle can be used in either of the following processes:

- **Multi-recycle with coupled LWRs and fast reactors:** a multi-stage fuel cycle in which plutonium and minor actinides in thermal reactor spent fuel are *burned* in a fast reactor
- **Multi-recycle with fast reactors:** a single-stage fuel cycle in which a fleet of fast reactors is used to breed fissile plutonium in blanket fuel surrounding the reactor so that fuel used in the central core can burn both plutonium and minor actinides

There are different proposals for dispersing minor actinides throughout a reactor core being used to promote their transmutation:

- **Homogeneous.** Minor actinides extracted by reprocessing operations are mixed with uranium and plutonium in fuel. The amount that can be mixed into this fuel is limited because of the impact on reactor core characteristics (i.e., reactivity). Note that this type of dispersal is similar to the use of MOX fuel, which already exists.
- **Heterogeneous.** Minor actinides are loaded into targets distinct and physically separate from the fuel used in the main reactor core. Excess neutrons from the reactor core are used to transmute the minor actinides placed in the targets. To achieve this type of dispersal of minor actinides, it is necessary to separate the minor actinides on an element-specific basis to ensure that targets contain the preferred minor actinides for transmutation. The technical development is more significant for this type of minor actinide dispersal because of the special processes needed to fabricate, reprocess, and recycling these targets.

### 3.1.2 REPROCESSING OPERATIONS

Within this context, reprocessing operations can be divided into distinct operational components [1]:

- The head-end process involves the processes needed to
  - separate the fuel matrix from structural materials associated with the fuel assembly
  - modify the chemical nature of the fuel to be compatible with downstream chemical separation processes
- Separation and conversion involves processes to
  - separate elements that can be recycled into fuel
  - convert the fuel into a chemical form usable in downstream fuel fabrication
- Waste management involves processes to support
  - Treatment of off-gases
  - Vitrification of fission products
  - Compaction of metallic wastes
- Auxiliary plant processes support a range of chemical process needs, as well as process control, maintenance, and accountability

A range of different methods for separation processes exist that can be divided into aqueous and nonaqueous methods. Nonaqueous methods typically rely on pyrochemical or pyroelectrochemical processes.

In addition to waste material generated during fuel separation processes, reprocessing operations will generate another stream of waste associated with material from the fuel and fuel assemblies (i.e., cladding and structural materials). In French operations, this waste stream of solid metallic material is usually compacted for storage in steel containers [1].

Finally, additional wastes are generated across the range of separation processes available for reprocessing operations:

- Solid wastes, including residues, structural materials and equipment, resins, filters, and personal protective equipment
- Organic or aqueous liquid wastes
- Gaseous wastes resulting from off-gases generated in different processes

### 3.2 SEPARATION PROCESSES

As noted above, separation processes can generally be categorized into aqueous and nonaqueous classes. A brief description of different processes in these two classes is provided below. The nonaqueous separation processes present some additional, unique hazards relevant to safety evaluations compared with aqueous processes. These additional hazards are relevant for this capability demonstration initiative, because demonstration of code capabilities for aqueous reprocessing has already been performed ([4]).

### 3.2.1 AQUEOUS SEPARATION PROCESSES

A range of aqueous separation processes has been developed. The recent US National Academy of Sciences study on advanced fuel cycles [1] identified the following processes:

- Uranium-only separation

This type of separation process is intended to extract remaining fissile uranium from spent fuel. Its primary output stream for recycling contains recovered uranium that must undergo re-enrichment. A range of processes has been developed to support this type of separation: Grouped Actinide Extraction (GANEX), New Extraction System for TRU Recovery (NEXT), Uranium Recovery by Extraction (UREX).

- Major actinide co-recovery

This process class is intended to extract uranium and plutonium, as well as neptunium, for fuel recycling. The PUREX process generates separate streams of uranium and plutonium. The Co-Extraction of Uranium and Plutonium (COEX), UREX and UREX+ processes are intended to support MOX fuel fabrication and recycling and to recover separated uranium and plutonium, or plutonium and neptunium as a group. The NEXT process removes uranium, plutonium, and neptunium together as a group in the recovered stream. This enables isolation of americium and curium, lanthanides, and other fission products for waste processing.

The only industrial and commercial reprocessing process that has been deployed is the PUREX process. This is an aqueous process that has approximately 60 years of operational experience [1]. The PUREX process generates two distinct output streams

- A stream of uranium and plutonium
- A nitric acid solution in which minor actinides are contained

Because the stream with minor actinides is high-level waste, it is further processed into a vitrified glass matrix that immobilizes minor actinides and nonvolatile fission products. This vitrified high-level waste is ultimately stored in solid form in a steel container.

- Transuranic actinide separation

This process class is intended to isolate transuranic elements. The GANEX process produces a recovery stream of plutonium, neptunium, americium, and curium that can be used in homogeneous transmutation in fast reactors. The Diamide Extraction (DIAMEX) and Transuranium Extraction (TRUEX) processes produce a recovery stream of lanthanides and actinides together as a group and are primarily used to remove trivalent lanthanides and actinides from PUREX liquid streams. The DIAMEX process can be combined with the Selective Actinide Extraction (SANEX) process to selectively extract certain actinides. The combination of the TRUEX process with Trivalent Actinide Lanthanide Separation with Phosphorus-Reagent Extraction from Aqueous Komplexes (TALSPEAK) has a similar objective. The goal of the DIAMEX-SANEX and TRUEX-TALSPEAK processes is to remove strong neutron absorbers from fuel so that americium and curium can be more effectively recycled using a heterogeneous dispersal process. An additional process called Extraction of Americium (EXAm) is used to separate americium from curium to limit the negative effects of the high neutron source term from curium when fabricating targets, thus addressing americium in a heterogeneous dispersal transmutation strategy.

- Cesium/strontium separation

This type of process is intended to facilitate management of short-term decay heat generators outside of a long-term geologic repository.

### 3.2.2 NONAQUEOUS SEPARATION PROCESSES

Nonaqueous separation processes are also referred to as *pyroelectrochemical processes*. They are primarily applied in spent fuel processing to reduce impurities in a metallic fuel (i.e., refining methods). The refining processes all rely on operations conducted in a molten salt (either a molten chloride or fluoride) at high temperatures ranging from 500°C to 900°C. The US National Academy of Sciences [1] study on advanced fuel cycles classifies types of processing methods as follows:

- **Electrorefining:** electrical currents are used to separate elements in a molten salt by anodic dissolution and metal deposition at the cathode. This is generally considered more appropriate for application to metallic fuels.
- **Liquid-liquid reductive extraction:** selective reduction and extraction of a metal from a molten salt into an immiscible liquid metal phase comprised of the reductant. This approach is most readily applied for oxide fuels, but it could also be applied to metallic fuels if they were suitably pretreated (i.e., oxide fuels must first be reduced to the metallic state).
- **Fluoride/chloride volatility:** Different volatilities of fluoride- or chloride-based compounds can promote the differential extraction of materials.

As a result of the development and application of electrorefining to Experimental Breeder Reactor II (EBR-II) spent fuel reprocessing, Argonne's method, called *Electrometallurgical Treatment (EMT)*, is the primary focus in this capability demonstration initiative. The overall process is illustrated in Figure 3.

The process involves the following primary stages, as schematically illustrated in Figure 4:

- The fuel is chopped and loaded into an anode basket. Fuel chopping is typically performed in a hot cell. Because metallic fuel, including metallic uranium and plutonium, is pyrophoric—that is, capable of self-ignition in air in the case of favorable conditions—this process must be performed with an inert atmosphere to prevent a pyrophoric hazard from developing.
- The anode basket is placed within a steel vessel containing a cadmium layer and an electrolyte salt (in this case LiCl and KCl) maintained at 500°C.
- An electric current is applied that promotes the transport of elements within the salt. Uranium primarily flows on to a solid cathode. Transuranics and uranium flow into a liquid cadmium cathode. Alkali metal, alkaline earth, and rare earth fission products tend to remain stable within the molten salt. Noble metal and some rare earth fission products are unstable in the salt and deposit out on the cadmium layer in the steel vessel. Zr from the fuel alloy also tends to deposit out on to the cadmium layer in the steel vessel.
- Deposits on the cathodes are consolidated through a melting process to be used in downstream fuel fabrication.

### 3.3 ACCIDENT SCENARIOS

The following key hazards arise during pyroelectrochemical processing:

- Pyrophoricity hazard
- Criticality hazard
- Radiation hazard

For each of these hazards, key accident scenarios have been selected based on the description of the overall processes as presented above.

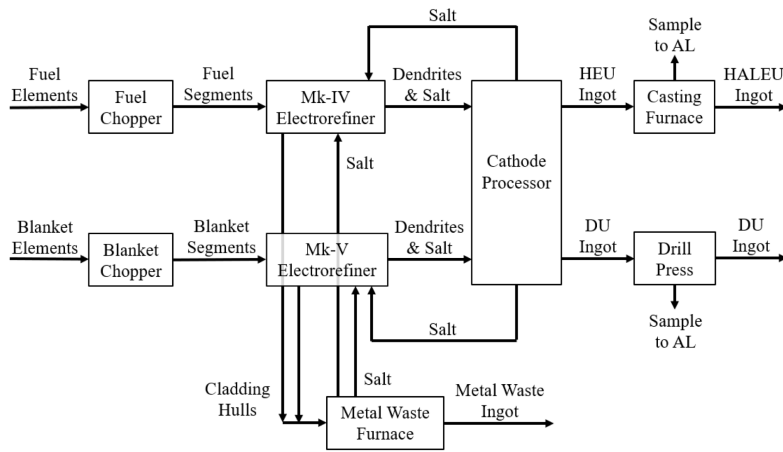


Figure 3. Electrometallurgical treatment process used for metallic fuel from the EBR-II [2].

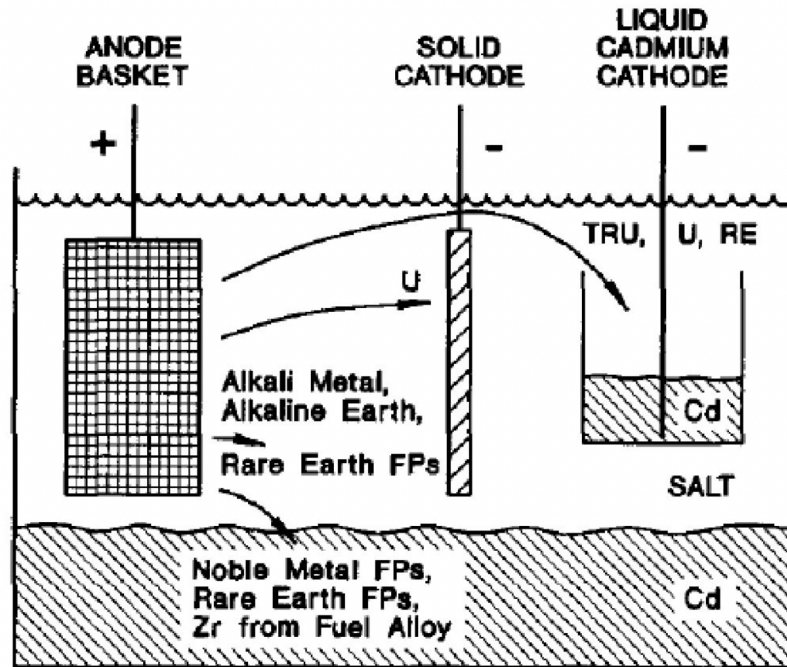


Figure 4. Schematic of the electrometallurgical treatment used for metallic fuel from the EBR-II [3].



## Pyrophoricity

- R1.1: An inert atmosphere in hot cells is lost, leading to ingress of O<sub>2</sub> and H<sub>2</sub>O. Metal combustion of uranium, plutonium, and other actinides, in this deinerted atmosphere can occur, leading to a release of volatile fission products and fuel particulates from the fuel being disassembled. Fission products will subsequently be able to escape from the hot cell through any pre-existing leakage paths.

## Criticality

- R1.2: Hygroscopic water uptake by salt with precipitation, leading to criticality
- R1.3: Misfeed of material into the anode basket, leading to an immediate criticality
- R1.4: Misfeed of materials into the electroprocessing batch, leading to criticality as materials collect on the cathode

## Radiological Material Release

- R1.5: Loss of adequate cooling promotes eutectic interaction of the TRU/U ingot with the storage containment, leading to a release of radioactive materials
- R1.6: Leak in the waste stream storage, allowing for release of fission products
- R1.7: Failure of the contaminated argon off-gas treatment system caused by a build-up of hydrogen with air ingress, causing a release of fission products
- R1.8: Failure of containment and/or heat removal during fuel rod disassembly
- R1.9: Off-gas leaks during the salt purification phase, leading to fission product release
- R1.10: Electrorefiner crucible overflow, splashing, or leak, leading to a hazardous collection of radioactive material
- R1.11: Noble metal processing heat malfunction, leading to vaporization of radioactive salt

## 3.4 REFERENCES

- [1] *Merits and Viability of Different Nuclear Fuel Cycles and Technology Options and the Waste Aspects of Advanced Nuclear Reactors*. Technical report, National Academies of Sciences, Engineering and Medicine, Washington, DC, 2022. URL: <https://doi.org/10.17226/26500>.
- [2] G. L. Fredrickson, M. N. Patterson, D. Vaden, G. G. Galbreth, T.-S. Yoo, J. C. Price, E. J. Flynn, and R. N. Searle. *History and Status of Spent Fuel Treatment at the INL Fuel Conditioning Facility*. Technical Report INL/JOU-21-62982, Idaho National Laboratory, Idaho Falls, ID, 2002. URL: <https://www.osti.gov/servlets/purl/1836040>.
- [3] J.J. Laidler, J.E. Battles, W.E. Miller, J.P. Ackerman, and E.L. Carls. Development of pyroprocessing technology. *Progress in Nuclear Energy*, 31(1):131–140, 1997. doi:10.1016/0149-1970(96)00007-8.
- [4] K. C. Wagner and D. L. Y. Louie. *MELCOR Modeling of Accident Scenarios at a Facility for Aqueous Reprocessing of Spent Nuclear Fuel*. Technical Report NUREG/CR-7266, US NRC, Washington, DC. URL: <https://www.nrc.gov/docs/ML2003/ML20030B798.pdf>.

## 4. FUEL FABRICATION/SYNTHESIS

This chapter summarizes the range of processes used to fabricate the types of fuels being considered for advanced non-LWR concepts. These include:

- Fabrication of TRISO fuel kernels and particles (see Figure 5)
- Fabrication of fuel pebbles or compacts containing TRISO fuel particles for HTGRs and FHRs (see Figure 6 for a schematic of the overall process)
- Fabrication of fuel salts to be used in fluid-fueled MSR (see Figure 7)
- Fabrication of metallic fuel slugs from either fresh or reprocessed fuel (see Figure 8), and Figure 9 for illustrations of some of these key processes)
- Fabrication of metallic fuel assemblies to be used in SFRs (see Figure 10 and Figure 11)
- Fabrication of metallic fuel assemblies to be used in HPRs

### 4.1 TRISO FUEL PARTICLE FABRICATION

In the United States, the TRISO fuel kernels for use in HTGR or FHR fuel pebbles will contain uranium oxycarbide (UCO) fuel. The production of these fuel kernels uses an internal sol-gel process with the following stages [9]:

- A solution of  $U_3O_8$  and nitric acid (uranyl solution) is dripped through a nozzle into a heated organic diluent (silicone oil)
- This solution is then mixed with urea, hexamethylenetetramine (HMTA), water, and carbon
- Under heat, the HMTA decomposes in such a manner that a gelation reaction occurs to eventually form the fuel kernel

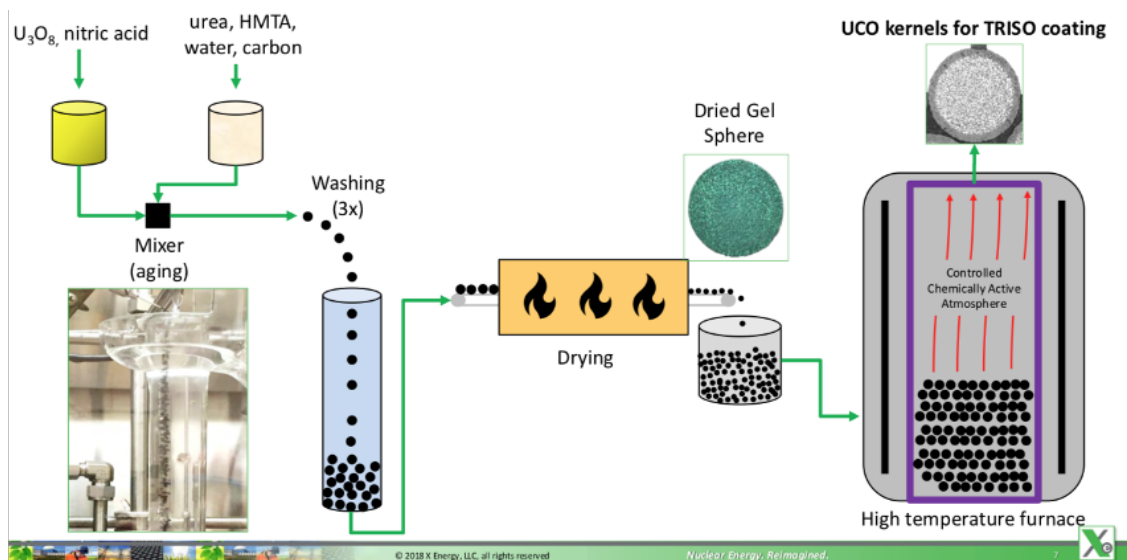


Figure 5. Illustration of TRISO Fabrication Process [5].

The fuel kernel formed through this sol-gel process is passed through subsequent stages that include washing, drying, and heating in a high-temperature furnace. After the kernels are released from the furnace, multiple

coatings are applied and prepared by passing the evolving fuel particle through different gas mixtures, as detailed below:

- The buffer layer is applied by passing the fuel kernel through a gas mixture of Ar and C<sub>2</sub>H<sub>2</sub> maintained at a temperature ranging from 1,400°C to 1,500°C.
- After the buffer layer is applied, the evolving particle is passed through a gas stream consisting of Ar, C<sub>2</sub>H<sub>2</sub>, and C<sub>3</sub>H<sub>6</sub> to apply the inner pyrolytic carbon layer (IPyC). The gas stream is maintained at a temperature ranging from 1,250°C to 1,350°C.
- After application of the IPyC layer, the SiC layer is applied by passing the evolving particle through a gas stream consisting of Ar, H<sub>2</sub>, and methyltrichlorosilane (MTS). The gas stream is maintained at a temperature ranging from 1,400°C to 1,500°C.
- Finally, the outer pyrolytic carbon (OPyC) layer is applied by passing the evolving particle through a gas stream comprised of Ar, C<sub>2</sub>H<sub>2</sub>, and C<sub>3</sub>H<sub>6</sub> maintained at a temperature ranging from 1,250° to 1,350°C.

Fabrication of the final fuel particles may lead to fire hazards, release of hazardous chemicals, and the occurrence of criticality.

### **Fire Hazard Scenarios**

- F1.1: Presence of a spark → HMTA explodes
- F1.2: Presence of a spark → HMTA ignites, causing a fire (but does not explode)
- F1.3: Presence of a heat/ignition source → Uranyl nitrate solution ignites in a fire
- F1.4: Presence of a heat/ignition source → Trichloroethane (TCE) explodes
- F1.5: Presence of a heat/ignition source → Acetylene explodes during the coating process
- F1.6: Presence of a heat/ignition source → Propylene explodes during the coating process
- F1.7: Presence of a heat/ignition source → MTS explodes during the coating process

### **Hazardous Chemical Release Scenarios**

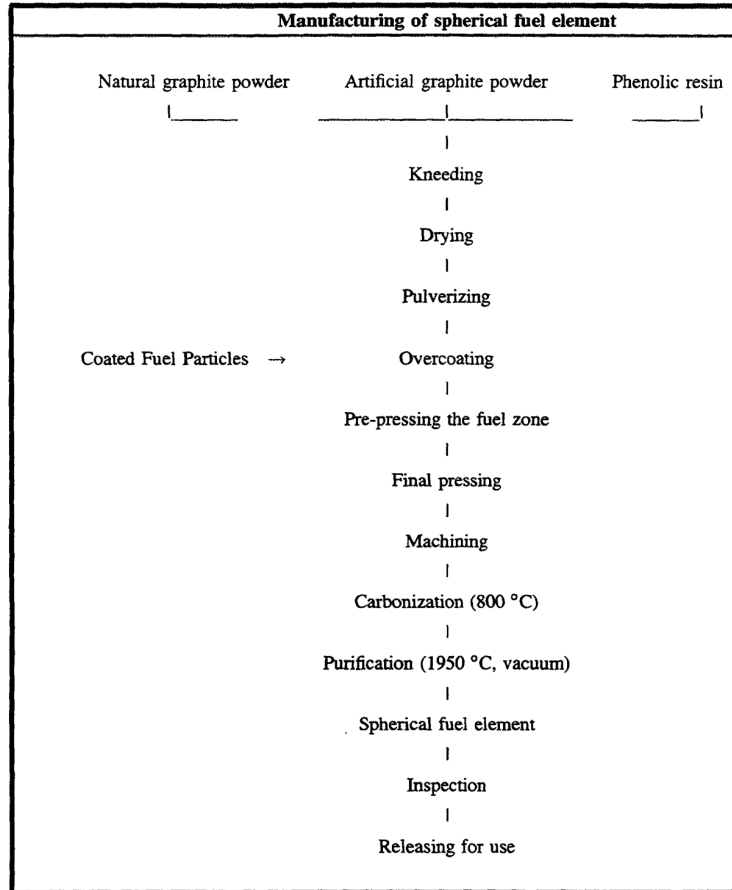
- F1.8: System leak → Thermal decomposition of uranyl nitrate solution causes toxic nitrogen oxides to form and escape into an unventilated room
- F1.9: System leak → Uranyl nitrate solution spill
- F1.10: System leak → Silicone oil spill
- F1.11: System leak → Thermal decomposition of trichloroethane (TCE) leading to formation of toxic gases and vapors
- F1.12: System leak → TCE spill
- F1.13: System leak → Decomposition of ammonium hydroxide
- F1.14: System leak → Ammonium hydroxide spill
- F1.15: System leak → MTS reaction with water
- F1.16: System leak → MTS leak into an unventilated room

### **Criticality Scenarios**

- F1.17: Improper handling of uranium nitrate hexahydrate solution leading to criticality
- F1.18: Flooding or water ingress into oxide fuel storage leading to criticality
- F1.19: Buildup of material, moderator or fissile material, in ducts or process stages leading to criticality

## 4.2 FUEL PEBBLE FABRICATION

The fabrication of fuel pebbles is an example to illustrate the type of hazards that could emerge during fuel pebble or compact fabrication. While multiple fuel design concepts using TRISO particles exist, for the purposes of capability demonstration, only the fuel pebble fabrication is considered as suitable exemplar covering the range of potential hazards that could emerge.



**Figure 6. Schematic of TRISO Pebble or Compact Fabrication Process [4].**

The fabrication of fuel pebbles is assumed to comprise the following stages:

- Graphite powder is dried and pulverized to be used to overcoat the TRISO particles. The temperature at which this occurs is assumed to be controlled.
- The overcoated TRISO particles in the fuel zone of the pebble are then pre-pressed, followed by machining.
- Carbonization of the fuel pebble is performed at a temperature of 800°C.
- Purification under vacuum conditions is then performed at a temperature of 1,950°C.
- The spherical fuel pebble is then released for inspection and ultimate use.

A number of scenarios can arise because of the distinct hazards encountered during pebble fabrication.

## Fire Scenarios

- F2.1: Abrasion and formation of graphite dust can result in a fire if a suitable ignition source and reactant are available.
- F2.2: Air ingress during heat treatment could lead to a fire.

## Chemical Interaction Hazard

- F2.3: Water ingress could result in fuel pebble corrosion.

## Criticality Scenarios

- F2.4: Improper storage of fuel pebbles with unexpectedly large enrichment → criticality.
- F2.5: Improper storage of fuel pebbles with addition of moderator fuel pebbles → criticality.
- F2.6: Storage of fuel pebbles with water ingress → criticality.
- F2.7: Storage of fuel pebbles with water flooding the storage area → criticality.
- F2.8: Improper handling of TRISO particles → criticality.

## 4.3 FUEL SALT SYNTHESIS

MSR design choices under current discussion vary widely and include exploration of their fuel salt composition. Besides the utilization of different fuel salt compositions and their operation with a thermal spectrum or a fast neutron spectrum, some MSRs could use spent fuel, and some MSRs could implement actinide recovery from the fuel salt. To demonstrate code capability, the most relevant fuel salts are considered here. In general, the fuel salt is a mixture of *fissile* and *carrier* salts. Additionally, some fast spectrum MSRs use blanket salts that can serve for breeding. Two major classes of fissile salt—fluoride salt and chloride salt—are discussed in the following sections.

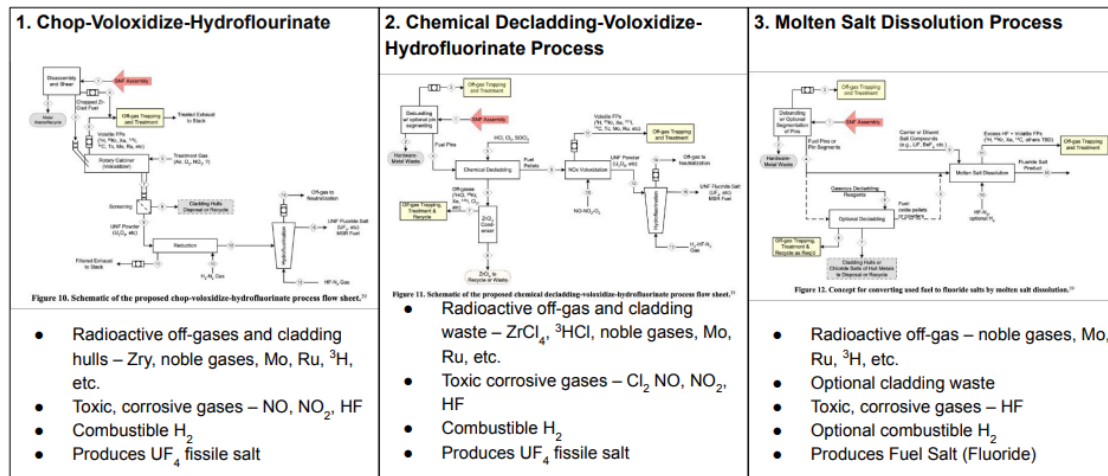


Figure 7. Schematic of Fuel Salt Fabrication Process [8].

### 4.3.1 FLUORIDE SALT

Different fluoride salts have been proposed for thermal spectrum MSR designs. Fissile fluoride salt is typically formed from (U/Pu/TRU)F<sub>4</sub>. This pure fissile salt has a melting temperature of 1,036°C and a boiling point of 1,417°C. It is dissolved in carrier salts formed from LiF, BeF<sub>2</sub>, ZrF<sub>4</sub>, and NaF. Different MSR test facilities or concepts have proposed different compositions for the molten fluoride salt mixture:

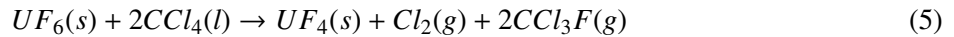
- The Molten Salt Reactor Experiment (MSRE) used a molten salt formed with a carrier and fuel salt, as follows [10]
  - LiF-BeF<sub>2</sub> carrier salt with composition 66-34 mol%
  - LiF-BeF<sub>2</sub>-ZrF<sub>4</sub>-UF<sub>4</sub> fuel salt with composition 65.0-29.1-5.0-0.9 mol%

The fuel was enriched to 34.5 wt% <sup>235</sup>U.

- The Integral Molten Salt Reactor (IMSR)-400 proposes a fluoride molten salt with UF<sub>4</sub> in a diluent fluoride mixture. The enrichment of fuel is proposed to be 2-3% at start-up with 5-19% for the makeup fuel [6].
- The Molten Salt Breeder Reactor (MSBR) concept uses a salt LiF-BeF<sub>2</sub>-ThF<sub>4</sub>-UF<sub>4</sub> with composition 71.7-16.0-12.0-0.3 mol% [11].

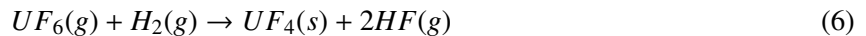
The fabrication of fissile salt UF<sub>4</sub> can be performed using a number of different processes [8].

The **carbon tetrachloride process** follows the chemical reaction given below:



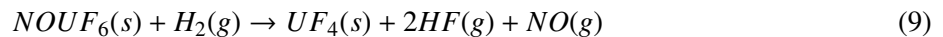
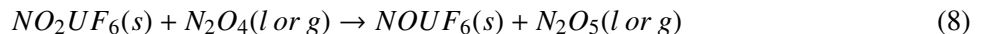
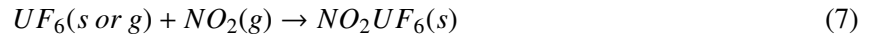
This process produces Cl<sub>2</sub> and CCl<sub>3</sub>F (freon), which are toxic, corrosive off-gases. In addition, CCl<sub>4</sub> is a suspected carcinogen.

The **hydrogen process** follows the chemical reaction given below:



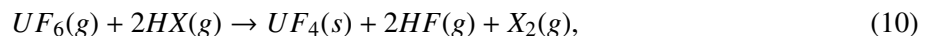
A byproduct of this process is HF, which is a toxic and highly corrosive off-gas. The reactant H<sub>2</sub> is a combustible gas.

The **NO<sub>x</sub> process** is a multi-step process that progresses according to the chemical reactions presented below:



The byproducts of this process—NO, NO<sub>2</sub>, and HF—are toxic and corrosive off-gases.

The **HBr, HCl, or HI process** follows the chemical reaction given below:



where X corresponds to either Br, Cl, or I.

The halide (Br<sub>2</sub>, Cl<sub>2</sub>, or I<sub>2</sub>) and hydrogen halide (HBr, HCl, or HI) off-gases from this process are toxic and corrosive.

Additional chemical processes can be used to produce fissile UF<sub>4</sub> salt from spent fuel. Some methods include the following:

- **Chop-Voloxidize-Hydrofluorinate.** This process produces radioactive off-gases and cladding waste. Toxic and corrosive off-gases are also byproducts (NO, NO<sub>2</sub>, and HF). Combustible H<sub>2</sub> is used in a reduction step of this process.
- **Chemical Decladding-Voloxidize-Hydrofluorinate.** This process generates radioactive off-gases and cladding waste. Toxic and corrosive off-gases (Cl<sub>2</sub>, NO, NO<sub>2</sub>, and HF) are produced during the process. In the hydrofluorination step, combustible H<sub>2</sub> gas is required.
- **Molten Salt Dissolution.** Radioactive off-gases are generated as a result of this process. If decladding is performed optionally in this process, then cladding waste will be generated. HF is produced, which is a toxic and corrosive off-gas. As part of the optional decladding process, combustion H<sub>2</sub> is used.

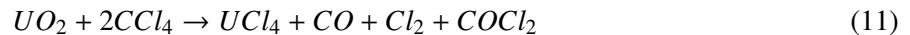
### 4.3.2 CHLORIDE SALT

The chloride salts proposed for fast spectrum MSR designs typically rely on UCl<sub>3</sub>, a fissile salt with a melting point of 837°C and a boiling point of 1,657°C. The fissile salt will often be a mixture of (U/Pu/TRU)Cl<sub>3</sub>. Carrier salts used are NaCl, CaCl<sub>2</sub>, and MgCl<sub>2</sub>. The Fast spectrum MSRs discussed in the open literature propose the use of UCl<sub>3</sub>-NaCl fuel salt:

- The Molten Chloride Fast Reactor (MCFR) proposes a fuel salt composition of UCl<sub>3</sub>-NaCl (0.333-0.667 mol%) with 12.5 (MCFR-C) and 19.75 (MCFR-D) wt% <sup>235</sup>U enrichment, respectively [2].
- The Molten Chloride Reactor Experiment (MCRE) proposed using UCl<sub>3</sub>-NaCl fuel salt with composition 0.333-0.667 mol% and with an enrichment of 93.2 wt% <sup>235</sup>U [12].

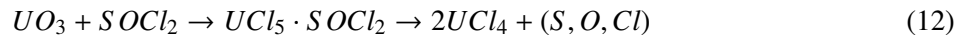
UCl<sub>3</sub> can be produced using a number of different chemical processes. The following chemical processes form UCl<sub>4</sub>, from which UCl<sub>3</sub> is ultimately produced [8].

The **carbochlorination** process follows the chemical reaction given below:



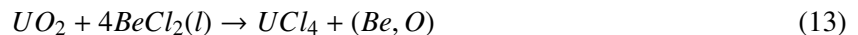
This process often relies on the production of UO<sub>2</sub> from UF<sub>6</sub>. The chemical reactions required to perform this can produce significant quantities of HF. Off-gases, Cl<sub>2</sub>, and COCl<sub>2</sub> (phosgene), are toxic and corrosive. In addition, CCl<sub>4</sub> is a suspected carcinogen.

The **Reflux Methods** process follows the chemical reaction presented below:



Off-gases formed from this process are toxic and corrosive.

The **Metathesis Reactions** process follows the chemical reaction given below:



Off-gases from this process are toxic and corrosive.

### 4.3.3 ACCIDENT SCENARIOS FOR PRODUCTION FROM FRESH FUEL

#### Loss of Process Confinement / Release

- Reactant supply line breach leading to a release of toxic and corrosive material
  - F1.1: Carbon tetrachloride process leading to a  $\text{CCl}_4(\text{l})$  release
  - F1.2:  $\text{NO}_x$  process leading to a release of  $\text{NO}(\text{g})$ ,  $\text{NO}_2(\text{g})$ , and  $\text{UF}_6$
  - F1.3: For the Hydrogen process,  $\text{H}_2(\text{g})$  release has the potential lead to a subsequent combustion
  - F1.4: For the hydrogen halide process, this will lead to a release of  $\text{HBr}(\text{g})$ ,  $\text{HCl}(\text{g})$ , or  $\text{HI}(\text{g})$
  - F1.5: For the carbochlorination process, a  $\text{CCl}_4(\text{l})$  release will occur
  - F1.6: For reflux methods, a  $\text{CCl}_4(\text{l})$  release will occur
  - F1.7: For the metathesis reactions, there will be a Be release (e.g.,  $\text{Be}_2$ ,  $\text{BeO}$ )
- Product exhaust line breach leading to a release of toxic and corrosive material
  - F1.8: For the carbon tetrachloride process, a  $\text{Cl}_2$  and  $\text{CCl}_3\text{F}$  release will occur
  - F1.9: For the  $\text{NO}_x$  process, release of  $\text{NO}(\text{g})$ ,  $\text{NO}_2(\text{g})$ , and  $\text{HF}(\text{g})$  will occur
  - F1.10: For the hydrogen process, there will be a  $\text{HF}(\text{g})$  release
  - F1.11: For the hydrogen halide processes, a release of  $\text{Br}_2$ ,  $\text{Cl}_2$ ,  $\text{I}_2$ ,  $\text{HBr}(\text{g})$ ,  $\text{HCl}(\text{g})$ , or  $\text{HI}(\text{g})$  will occur
  - F1.12: For the carbochlorination process, a release of  $\text{Cl}_2$  and  $\text{COCl}_2$  will occur
  - F1.13: For the reflux Methods, a release of  $\text{Cl}_2$  and  $\text{COCl}_2$  will occur
  - F1.14: For the metathesis reactions, Be compounds (such as  $\text{Be}_2$  and  $\text{BeO}$ ) will be released
- Mixing with air causing the formation of combustible mixtures and corrosive materials.
  - F1.15: The hydrogen process has the potential for  $\text{H}_2(\text{g})$  release and subsequent combustion.
  - F1.16: In the  $\text{UCl}_3$  production methods,  $\text{UCl}_4$  interacts with air (if air ingress occurs) to form hydrochloric acid.

#### Criticality

- F1.17: Accumulation of uranium source material in the reaction vessel or off-gas system leading to a critical configuration
- F1.18: Accumulation of final uranium product material in the reaction vessel or off-gas system leading to a critical configuration
- F1.19: Over-addition of fissile salt during fuel salt synthesis leading to a critical configuration



#### 4.3.4 ACCIDENT SCENARIOS FOR PRODUCTION FROM SPENT FUEL

##### Loss of Process Confinement

- Reactant supply line breach leading to a release of toxic and corrosive material
  - F1.20: For all methods, there is a risk of HF release
  - F1.21: For the Chemical decladding-voloxidize-hydrofluorinate and molten salt dissolution processes, there is a risk of HCl, Cl<sub>2</sub>, and other chloride compounds being released
  - F1.22: For the Chop-voloxidize-jydrofluorinate and chemical decladding-voloxidize-hydrofluorinate processes, there is a risk of NO and NO<sub>2</sub> release
  - F1.23: For all methods, there is a risk of combustible H<sub>2</sub> gas release leading to the possibility of a combustible atmosphere developing
- Product exhaust line breach leading to a release of toxic and corrosive material
  - F1.24: For all methods, there is a risk of HF release
  - F1.25: For the chemical decladding-voloxidize-hydrofluorinate and molten salt dissolution processes, there is a risk of HCl, Cl<sub>2</sub>, and other chloride compounds being released
  - F1.26: For the chop-voloxidize-hydrofluorinate and chemical decladding-voloxidize-hydrofluorinate processes, there is a risk of NO and NO<sub>2</sub> release
  - F1.27: For all methods, there is a risk of combustible H<sub>2</sub> gas release leading to possible development of a combustible atmosphere
  - F1.28: For all methods, there is a risk of fissile salt release
- Mixing with air causing the formation of combustible mixtures and corrosive materials
  - F1.29: For all methods, there is a risk of combustible mixtures forming, leading the potential for a combustion event within an enclosure

##### Criticality

- F1.30: Over-addition of fissile salt during fuel salt synthesis leading to a criticality configuration

##### Loss of Off-Gas System Confinement / Release

- F1.31: For all candidate methods, a loss of off-gas system confinement will result in fission product release
- F1.32: For the chemical decladding-voloxidize-hydrofluorinate process, an additional release of <sup>3</sup>HCl and Cl<sub>2</sub> will occur

##### Loss of Decay Heat Removal Function

- F1.33: Increased filter temperatures causing a degradation of filter efficiency leading to a release of fission products from the filters

#### 4.4 METALLIC SFR/HPR FUEL FABRICATION

Although SFR concepts with both oxide and metallic fuel have been proposed, only metallic fuel is considered in this project because of current SFR activities by industry and researchers in the United States. The SFR fuel fabrication stages were developed based on the extensive experience of metallic fuel fabrication for the Experimental Breeder Reactor I (EBR-I) (production of approximately 100,000 Mark-I fuel elements) and EBR-II (fabrication of approximately 1,000 fuel assemblies and 120,000 fuel rods) programs.

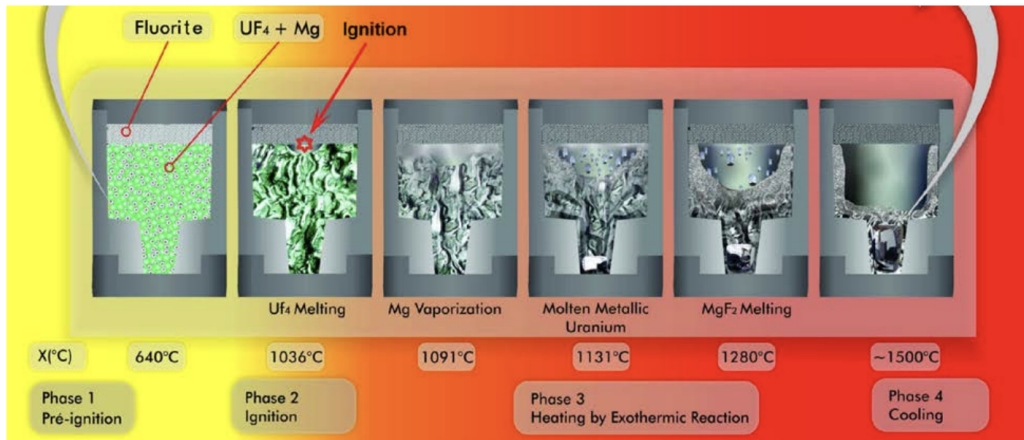
The process to fabricate metallic fuel has three major steps [7].

In the first step, enriched uranium is processed into a metallic form. This typically involves a reduction process. Several processes can be used, depending on the nature of the input uranium.

For  $UF_4$ , a reduction reaction such as the following could be used:



This reaction typically requires a mixing process that also adds heat, and slab byproducts from the reaction must be removed. Note that Ca or Al could be used to reduce metal instead of the Mg shown in the above reaction.

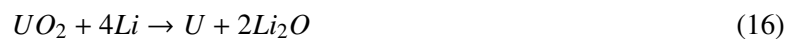


**Figure 8. Illustration of  $UF_4$  Reduction Process [7].**

For  $UO_2$ , there are other candidate reactions. A metal reduction reaction such as the following could be used:

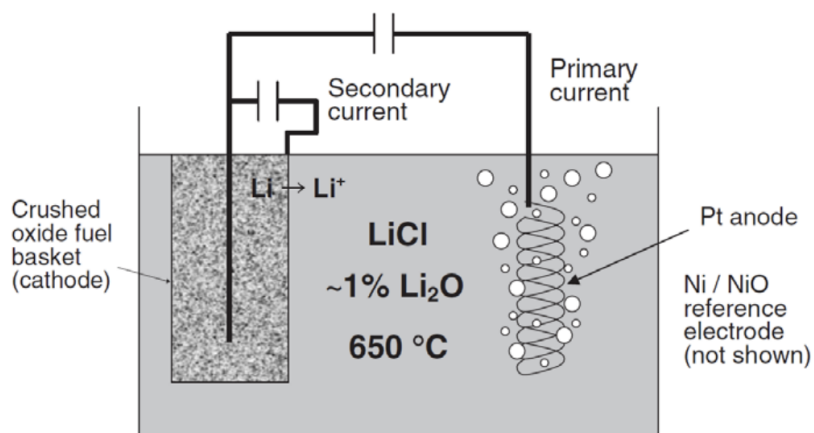


This reaction typically requires very high temperatures. Alternatively, an electrolytic reaction could be used. Note that Ca or Al could be used to reduce metal instead of the Mg shown in the above reaction.



The metallic uranium is retained on the cathode for subsequent extraction.

In the second step, a metallic slug is formed through an alloying and casting process. Vacuum induction melting is the most widely used method.



**Figure 9. Illustration of UO<sub>2</sub> Reduction Process [3].**

In the third major step, after the formation of fuel slugs, machining and thermal-mechanical processing are used to form the metallic fuel pellet.

Note that input streams of fissile material could use reprocessed material from spent fuel as discussed in Section 3. This introduces additional radiation hazards. Additional considerations are introduced for a reactor concept such as the Advanced Burner Test Reactor (ABTR), which uses weapons-grade Pu and transuranics in the fuel fabrication process.

These operations result in the following accident scenarios and initiating events that result from pyrophoric and other chemical substance hazards, criticality hazards, and electrical hazards.

### Pyrophoricity Hazard

- F1.1: Rupture or ignition of the calcium or magnesium supply container used in vacuum induction melting could lead to fire damage of other containers. Ultimately, the fire could result in volatilization of toxic chemicals. Inhalation of calcium presents a toxicity risk.
- F1.2: Air ingress occurring during the cold and hot rolling stages could result from a failure of the uranium metal mold during vacuum induction melting or post-handling. Because uranium is highly pyrophoric, this could result in release of uranium that could ultimately present an inhalation risk.
- F1.3: In-leakage of oxygen during furnace annealing would lead to ignition of a uranium slug, thus causing gaseous releases.
- F1.4: Vacuum induction melting chamber could leak while an exothermic reaction is occurring (bomb phase), thus leading to a release of gaseous Mg and uranium.
- F1.5: Residual uranium metal could be retained in the casting mold and could thus ignite in the waste storage area.

### Hazardous Chemical Release

- F1.5: Hazardous chemicals such as TCE, NaOH, nitric acid, or HF could vaporize and be spilled or could leak into the process chamber.
- F1.6: The UF<sub>4</sub> supply to the vacuum induction melting tank could leak, presenting a risk of fluorine release. Fluorine is highly corrosive to most metals.

- F1.7: Gaseous HF acid byproduct could leak during the fabrication process, thus presenting a toxicity risk.

### **Criticality**

- F1.8: Weapons-grade Pu could be misfed or mishandled in the transition from T2 to F1, thus causing the crucible supply chamber to overfill and reach a critical configuration.
- F1.9: The storage area for fuel slugs could be flooded, thus leading to a critical configuration.
- F1.10: A crucible crack in the hot cell could cause molten fuel to leak and collect in a configuration that achieves criticality.

### **Radiological Material Release**

- F1.11: Leak of supply containers for the weapons grade Pu and transuranics.
- F1.12: Volatile transuranic element leak during hot cell casting involving leakage of americium or plutonium.
- F1.13: Plutonium leak during casting activities. Previous experience indicates that plutonium leaks when casting is performed with plutonium-containing alloys.

### **Electrical Hazard**

- F1.14: Arcing from induction coils short circuits could result in a fire of the residual fuel dust.

## **4.5 METALLIC SFR FUEL ASSEMBLY FABRICATION**

The fabrication of metallic SFR fuel assumed for the development of accident scenarios is based on the discussion provided by D. E. Burkes et al. [1]. Additionally, the cladding material must satisfy some performance requirements, including satisfactory mechanical performance (e.g., creep and yield strength), satisfactory ductility at refueling temperatures following irradiation, low void swelling when subject to high fast neutron doses, and compatibility with the fuel and reactor coolant. Additional beneficial characteristics of the fuel cladding include performance at higher burnups (ranging from 10 at.% to 20 at.%) under high linear power, heat rates, and surface heat fluxes. Cladding must furthermore not impede future reprocessing operations.

The overall process for fabricating metallic SFR fuel assemblies is depicted in Figure 10. This process diagram includes the stages involved in fuel slug fabrication. The explicit steps involved to fabricate a fuel assembly are highlighted in Figure 10. Following fabrication of the fuel slugs, fuel rod fabrication is performed according to the following stages:

1. A fuel cladding tube is fabricated and cleaned
2. The cladding tube is loaded with sodium to facilitate bonding
3. Fuel slugs are loaded into the cladding tube
4. The fuel cladding tube is closure welded to achieve sealing

The sealed fuel rod is tested to ensure that its dimensions adhere to specifications. Helium leak testing is finally performed to ensure that the fuel rod is appropriately sealed.

Following fabrication of fuel rods, a fuel assembly is manufactured. The EBR-II fuel assemblies included 91 fuel rods arranged in a hexagonal array. The EBR-II fuel assembly consisted of a lower adaptor, lower blanket section, core section, and upper blanket section. Fuel assemblies used in the EBR-II Core I fuel

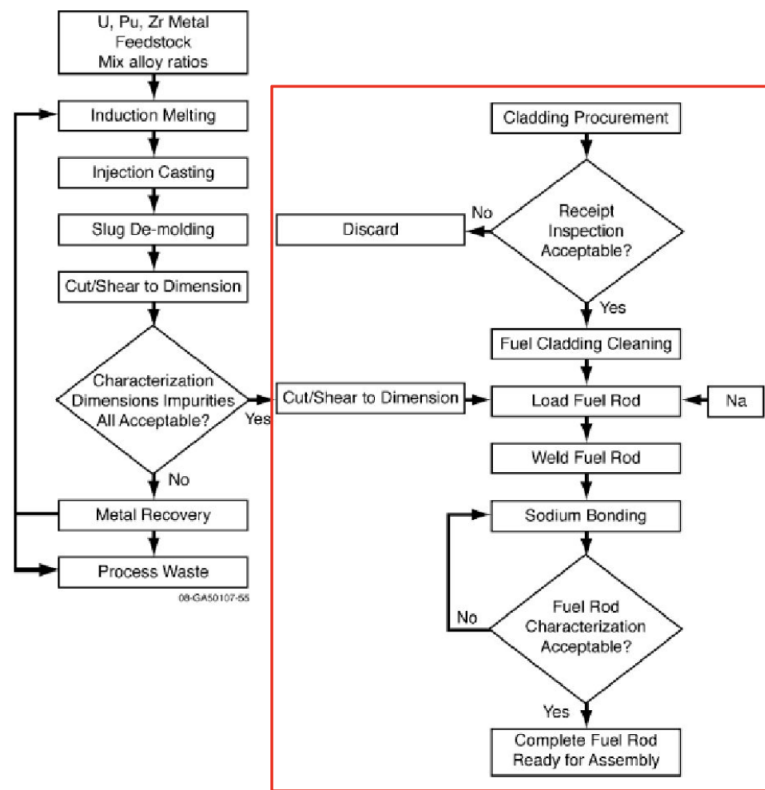
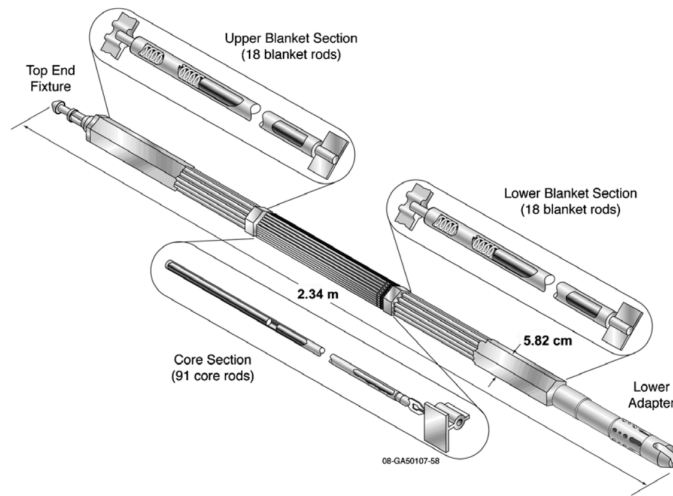


Figure 10. Schematic illustration of SFR metallic fuel fabrication process [1].

loading were manufactured in a hot cell in a vertical position. Because the fuel was processed using melt refining, there was a large content of fission products remaining in the fuel that caused fuel temperatures to exceed sodium melting. While much of the fuel assembly fabrication process involves arranging the fuel rods into a hexagonal configuration, the fixture of the fuel rod assembly to the lower adaptor requires a series of arc welds. This ensures that each assembly could withstand 13.3 kN of tensile load. Figure 11 provides an illustration of the fuel assembly used for the EBR-II.



**Figure 11. Schematic illustration of EBR-II metallic fuel assembly [1].**

The following introduces the pyrophoricity hazard. There are additional hazards, such as criticality, that are introduced under the discussion of the HPR hazard discussion. Most of these criticality hazards can be considered relevant to the SFR. However, it is important to note that the realization of a criticality hazard is very specific to the details of the process under consideration.

### **Pyrophoricity Hazard**

- F2.1: Sodium bond wiring is exposed to water and reacts to form  $H_2$ . This is an exothermic reaction. The hydrogen released could combust in an enclosure atmosphere.
- F2.2: Cold rolling, which is used to straighten fuel rods, uses kerosene as a lubricating agent. A spill of kerosene could lead to a fire if it ignites.
- F2.3: Air ingress into the hot cell during end cap welding could cause sodium to ignite, resulting in release of fission gases from fuel rods.

## **4.6 METALLIC HPR FUEL ASSEMBLY FABRICATION**

The fabrication of metallic HPR fuel is assumed to be similar to the fabrication of metallic SFR fuel. It is also assumed that the fabrication of a fuel block in an HPR is similar to the fabrication of a fuel rod in a metallic SFR as described in more detail in [1]. The differences relative to SFR metallic fuel are due to the unique aspects of an HPR assembly. For each fuel rod, it is assumed that it has a central region occupied by a heat pipe that removes heat from the fuel (Figure 35).

Due to the presence of a heat pipe in the center of the overall assembly, the manufacturing of this fuel-heat pipe assembly is subject to the following assumptions relative to fabrication of traditional metallic fuel:

- Each fuel pellet can be loaded at the fuel rod and fabrication facility.
- Each heat pipe and clad fuel element can be individually fabricated, tested, inspected, and qualified prior to installation in the reactor core.
- Defective fuel elements can be easily detected and replaced.
- Heat pipes can be fabricated in a separate factory with material testing and inspection of the stainless steel heat pipe, potassium metal, and wick.
- Heat pipe components can be assembled and filled with liquid metal potassium in a temperature- and pressure-controlled environment.

### Criticality

- F2.1: Inspection failures promoting conditions for a criticality event
- F2.2: Water ingress with fuel elements in storage, thus leading to a critical configuration
- F2.3: Realization of critical configuration during the overcoating and uranium recovery processes

### Radiological Material Release

- F2.4: Inspection failures resulting in the potential for radiological release under operating conditions
- F2.5: Fire at fuel loading when the core is being manufactured (assumed to be in a factory), thus promoting radiological release
- F2.6: Weld failures that promote failure of heat pipes under operating conditions
- F2.7: Water ingress into a heat pipe with liquid metal potassium causing a fire because of the potassium-water interaction to promote a radiological release from overheated fuel

## 4.7 REFERENCES

- [1] D. E. Burkes, R. S. Fielding, D. L. Porter, D. C. Crawford, and M. K. Meyer. A US Perspective on Fast Reactor Fuel Fabrication Technology and Experience Part 1: Metal Fuels and Assembly Design. *Journal of Nuclear Materials*, 389:458–469, 2009. doi:10.1016/j.jnucmat.2009.02.035.
- [2] T. Cisneros, M. Wargon, and J. Latkowski. *Representative Neutronics Models of MCFR Reactors*. Technical Report MCFR-ENG-PRSNT-0021, TerraPower, Bellevue, WA, 2023.
- [3] S. Herrmann, S. Li, and M. Simpson. Electrolytic Reduction of Spent Light Water Reactor Fuel Bench-Scale Experiment Results. *Journal of Nuclear Science and Technology*, 44:361–367, 2007. doi:10.1080/18811248.2007.9711295.
- [4] IAEA. *Fuel performance and fission product behavior*. Technical Report IAEA-TECDOC-978, International Atomic Energy Agency, 1997. URL: [https://www-pub.iaea.org/MTCD/Publications/PDF/te\\_978\\_prn.pdf](https://www-pub.iaea.org/MTCD/Publications/PDF/te_978_prn.pdf).
- [5] IAEA. *Evaluation of High Temperature Gas Cooled Reactor Performance: Benchmark Analysis Related to the PBMR-400, PBMM, GT-MHR, HTR-10 and the ASTRA Critical Facility*. Technical Report IAEA-TECDOC-1694, International Atomic Energy Agency, 2013. URL: [https://www-pub.iaea.org/MTCD/Publications/PDF/TE-1694\\_{\\_}web.pdf](https://www-pub.iaea.org/MTCD/Publications/PDF/TE-1694_{_}web.pdf).
- [6] IAEA. *Status Report – IMSR-400*. <https://aris.iaea.org/PDF/IMSR400.pdf>, 2023. Accessed: 2023-01-04.

- [7] N.L. LaHaye and D.E. Burke. *Metal Fuel Fabrication Safety and Hazards: TO NRC-HQ-25-17-T-005, Non-LWR LTD2*. Technical Report PNNL-28622, Pacific Northwest National Laboratory, Richland, WA, 2019. URL: <https://www.nrc.gov/docs/ML1919/ML19193A057.pdf>.
- [8] J. McFarlane, P. Taylor, D. Holcomb, and W. P. Poore. *Review of Hazards Associated with Molten Salt Reactor Fuel Processing Operations*. Technical Report ORNL/TM-2019/1195, Oak Ridge National Laboratory, Oak Ridge, TN, 2019. URL: <https://info.ornl.gov/sites/publications/Files/Pub126864.pdf>.
- [9] P. Pappano. TRISO-X Fuel Fabrication Facility Overview, Introductory Meeting with the NRC. <https://www.nrc.gov/docs/ML1825/ML18254A086.pdf>, 2016. Accessed: 2017-03-04.
- [10] R. C. Robertson. *MSRE Design & Operations Report Part 1 Description of Reactor Design*. Technical Report ORNL-TM-728, Oak Ridge National Laboratory, Oak Ridge, TN, 1965. doi: [10.2172/4654707](https://doi.org/10.2172/4654707).
- [11] R. C. Robertson. *Conceptual Design Study of a Single-Fluid Molten-Salt Breeder Reactor*. Technical Report ORNL-4541, Oak Ridge National Laboratory, Oak Ridge, TN, 1971. URL: <https://www.osti.gov/servlets/purl/4030941>.
- [12] D. Walter, T. Cisneros, D. Wardle, J. Walter, and S. Findlay. *MCRE Design Description in Support of External Model Development*. Technical Report MCRE-ENG-PRSNT-0029, TerraPower, Bellevue, WA, 2022. URL: [https://www.researchgate.net/publication/369261248\\_MCRE\\_Design\\_Description\\_in\\_Support\\_of\\_External\\_Model\\_Development](https://www.researchgate.net/publication/369261248_MCRE_Design_Description_in_Support_of_External_Model_Development).



## 5. TRANSPORTATION

This chapter presents the transportation stages T1 and T2 for the non-LWR fuel cycles. The transportation of enriched UF<sub>6</sub> is applicable to all non-LWR fuel cycles, although different enrichments may apply. The HTGR and the FHR fuel cycles both require transportation of fuel pebbles. Transportation of fissile salt is discussed for the MSR fuel cycle, and for the SFR and HPR fuel cycle, transportation of the metallic fuel assemblies is discussed. Specifically, this section identifies current packaging designs that can accommodate these new fuel types and may be used in various scoping analyses. For the context of the identified accident scenarios, it is noted again here that the listed scenarios include all conceivable scenarios, independently of their probability to occur, and including beyond design basis accidents. For example, beyond-design basis criticality events are considered, such as misloading events where the package contents would exceed permitted quantities of fissile or heterogeneous material. However, many listed criticality scenarios have been analyzed in the respective transportation canister's Safety Analysis Report in which it was demonstrated that the package remains subcritical under the conditions specified in 10 CFR 71.

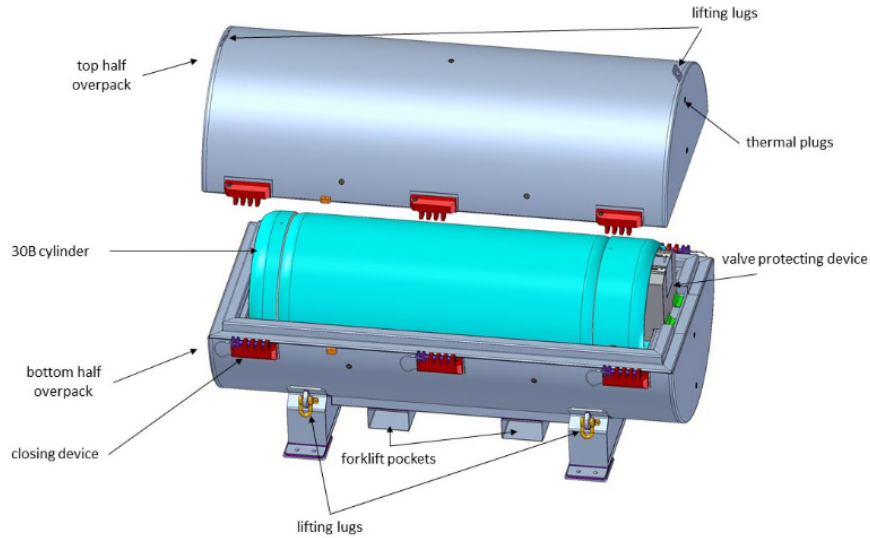
### 5.1 UF<sub>6</sub> TRANSPORTATION

Containers used to transport UF<sub>6</sub> are listed in American National Standards Institute (ANSI) document ANSI N14.1 [2]. For UF<sub>6</sub> with uranium enrichment of up to 5 wt%, the 30B cylinder and the associated DN30 protective structural packaging (PSP) overpack are the most commonly used cylinders for commercial transportation (Figure 12). Cylinder 8A is licensed for an enrichment of up to 12.5 wt%, which could cover the enrichment needed for certain non-LWRs. However, many non-LWRs rely on HALEU with enrichments of just below 20 wt%, which would require the use of cylinders 5A and 5B that permit UF<sub>6</sub> enrichments up to 100 wt%. Using cylinders 5A, 5B, or 8A for commercial levels of production and transportation is economically less attractive and introduces a challenge for material accountancy because many more cylinders would be required than if the 30B cylinder could be used [5]. The 30B cylinder limits the content of UF<sub>6</sub> to 2,277 kg (5,020 lb), which is 90% of the 30B cylinder volume at a liquid state. In contrast, the capacity of an 8A cylinder is approximately 115 kg (~5.1% the capacity of the 30B), and the capacity of a 5B cylinder is approximately 25 kg (~1.1% the capacity of the 30B).

To address this limitation, the DN30-X package was developed, which consists of the 30B-X cylinder and the same DN30 PSP that is used for the DN30 package [13]. The outer PSP acts as a shock absorber during drop tests and provides thermal protection in fire tests. The 30B-X cylinder has the same dimensions as the established 30B cylinders, but it also incorporates a criticality control system (CCS). The CCS consists of seamless criticality control rods filled with the neutron poison boron carbide (B<sub>4</sub>C). Three lattice holders ensure the placement of the rods, and longitudinal stiffeners between the lattice holders help keep the lattice holders separated from each other. The license application for this package has been recently approved by the NRC [19].

The DN30-X package with details according to the nonproprietary safety analysis report [13] is used for UF<sub>6</sub> transportation for this project. DN30 packages filled with UF<sub>6</sub> are usually transported on a flat rack with four DN30 packages, and the same configuration can be assumed for this work.

To determine comprehensive lists of potential accident scenarios for the transportation of the DN30-X package, IAEA safety standard TS-R-1 "Regulations for the Safe Transport of Radioactive Materials" [6], 10 CFR Part 71, "Packaging and Transportation of Radioactive Materials" [11], and several criticality safety studies [4, 14, 15] were reviewed.



**Figure 12. DN30 package for UF<sub>6</sub> transportation [12].**

### Criticality

- T1.1: Water surrounding the array of canisters at optimal moderator-to-fuel ratio and optimal canister → criticality
- T1.2: Water surrounding the array of canisters (water reflection around canisters) with fully flooded canisters at optimal moderator-to-fuel ratio → criticality
- T1.3: Low ambient temperatures → criticality at low temperatures
- T1.4: Water ingress into the array of canisters at optimal moderator-to-fuel ratio, considering hydrogenated uranium residue (HUR) spheres of UO<sub>3</sub>F<sub>2</sub>·3 H<sub>2</sub>O [15] → criticality
- T1.5: Damage to container resulting from drop → reduced container array spacing → criticality
- T1.6: Loss of overpack resulting from vehicle accident → reduced container array spacing → criticality

### Release

- T1.7: Fire resulting from vehicle accident → melt/burn/combustion of overpack (foam insulation)
- T1.8: Fire resulting from vehicle accident → combustion of melting of plugs → venting of gases
- T1.9: Impact resulting from vehicle accident → rupture of container or valve → release of UF<sub>6</sub> gas

## 5.2 FUEL PEBBLE TRANSPORTATION

At this writing, there are few transportation canisters specifically designated to transport fresh HTGR or FHR fuel pebbles. The Versa-Pac transportation canister (Figure 13) is licensed to transport components including fuel pebbles with enrichments of up to 100% [3, 18] and has been considered in other studies as potential transportation canister for fuel pebbles [8]. The principal design of the Versa-Pac packaging maintains the use of an inner container positioned inside a 55-gallon (VP-55) or 110-gallon drum (VP-110). The maximum allowed <sup>235</sup>U mass in both the VP-55 and the VP-110 is determined by <sup>235</sup>U enrichment (Table 2). Depending on the dimensions, uranium content, and <sup>235</sup>U enrichment of the fuel pebbles, a maximum number of fuel pebbles permitted to be transported within one container can be determined which results in the use of a

**Table 2. Versa-Pac maximum  $^{235}\text{U}$  per package (ground transportation) [18]**

Enrichment [wt%]	$^{235}\text{U}$ mass limit [g]
$\leq 100$	360
$\leq 20$	445
$\leq 10$	505
$\leq 5$	610
$\leq 1.25$	1650

VP-55 or a VP-110 canister. Details of dimensions and materials of the VP-55 container can be found in the safety analysis report [3].

To determine comprehensive lists of potential accident scenarios for the transportation of the VP-55 package, IAEA safety standard TS-R-1 “Regulations for the Safe Transport of Radioactive Materials” [6], 10 CFR Part 71 “Packaging and Transportation of Radioactive Materials” [11], and several criticality safety studies [4, 14, 15] were reviewed. The scenarios are similar those identified for the DN30-X cylinder, with additional consideration of the graphite material in the fuel pebbles.

### Criticality

- T2.1: Water surrounding the array of canisters at optimal moderator-to-fuel ratio and optimal canister → criticality
- T2.2: Water ingress into the array of canisters at optimal moderator-to-fuel ratio → criticality
- T2.3: Water surrounding the array of canisters with simultaneous water ingress at optimal moderator-to-fuel ratio → criticality
- T2.4: Ambient temperatures varying between  $-40^{\circ}\text{C}$  and  $38^{\circ}\text{C}$  → criticality at low temperatures
- T2.5: Container drop → damage to container → reduced container array spacing → criticality
- T2.6: Vehicle accident → damage to container with release of fuel pebbles → rearrangement of fuel pebbles from all containers on vehicle → criticality

### Release

- T2.7: Vehicle accident → fire → fire of fuel pebble graphite
- T2.8: Vehicle accident → fire → extinguishing water contacts graphite at high temperature → graphite corrosion and development of graphite dust

## 5.3 TRANSPORTATION OF FUEL SALT

Because no specific transportation container has been identified for fissile salts  $\text{UF}_4$  or  $\text{UCl}_3$ , it is reasonable to use transportation package DN30-X as used for the  $\text{UF}_6$  transportation (see Section 5.1). The accident scenarios and hazards related to the release of the container contents are similar.

McFarlane et al. [10] describe similar transportation hazards for  $\text{UF}_4$  as for  $\text{UO}_2$ , except that  $\text{UF}_4$  can have a very slow reaction with water to produce uranyl fluoride ( $\text{UO}_2\text{F}_2$ ) and HF. The CHT-OP-TU container is certified for a variety of uranium bearing materials, including powders or crystalline forms, with enrichments up to 5 wt%  $^{235}\text{U}$  [16]. Although enrichment is currently limited to 5 wt%, it is considered to be a suitable packaging for fuel salts, while the limiting characteristics of the fuel salts for transportation must be determined from safety analyses.

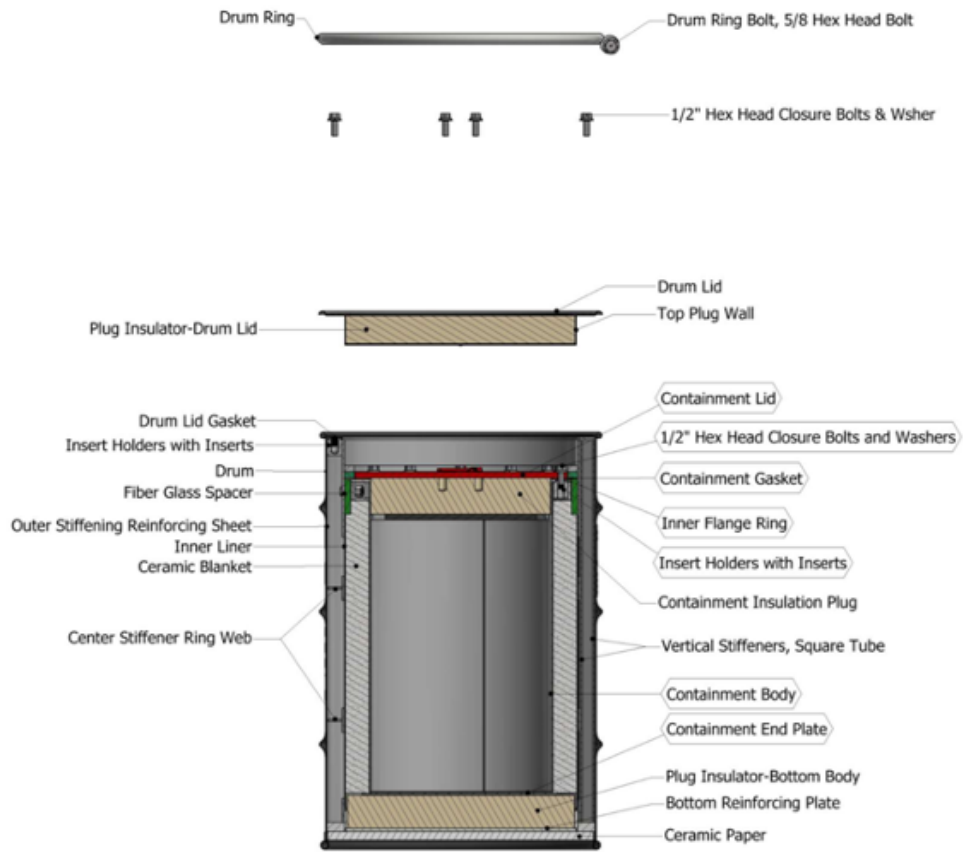


Figure 13. Versa-Pac transportation canister [3].

## Criticality

- T2.1: Water surrounding the transportation container → criticality
- T2.2: Water ingress into container → criticality
- T2.3: Damage to container resulting from drop → reduced container array spacing → criticality
- T2.4: Loss of overpack resulting from vehicle accident → reduced container array spacing → criticality

## Release

- T2.5: Fire resulting from vehicle accident → melt/burn/combustion of overpack (foam insulation)
- T2.6: Fire resulting from vehicle accident → build-up of vapors and pressurization in cylinder → combustion or melting of plugs → venting of gases
- T2.7: Moisture and oxygen contamination → corrosion of container resulting from high corrosivity of fuel salt and buildup of HF/HCl/UF<sub>6</sub>
- Fluoride salt-specific:
  - T2.8: Water ingress → very slow reaction of UF<sub>4</sub> with water to produce uranyl fluoride (UO<sub>2</sub>F<sub>2</sub>, toxic, health and environmental hazard) and HF (toxic, corrosive)
  - T2.9: Damage to container → Be release resulting from leak of salt
- Chloride salt-specific:
  - T2.10: Release of oxides/hydroxides (CCl<sub>4</sub>, Cl<sub>2</sub>, COCl<sub>2</sub>, HCl)

## 5.4 SFR FUEL ASSEMBLY TRANSPORTATION

A cask for commercial transportation of newly fabricated metallic SFR fuel has not yet been identified. A possible candidate for transporting this type of fuel is a cask similar to the ES-3100 [17] or another Type-B shipping container [1, 7] (Figure 14). The ES-3100 package is a Type-B shipping container that is approximately 110 cm in overall height and 49 cm in overall diameter and is composed of an outer drum assembly and an inner containment vessel. The containment vessel is placed inside the drum and surrounded by a cement based borated neutron absorber. The purpose of the ES-3100 is to transport bulk high enriched uranium in various forms. It is certified for a variety of uranium bearing materials, including alloys, metals, uranium oxides, uranyl nitrate crystals, with enrichments up to 100 wt% <sup>235</sup>U. Loading limits are determined from the enrichment, the material form, and the presence of spacers.

## Criticality

- T1.1: Water surrounding the array of canisters at optimal moderator-to-fuel ratio and optimal canister → criticality
- T1.2: Water ingress into the array of canisters at optimal moderator-to-fuel ratio (consider homogeneous sphere of UF<sub>6</sub> and water, surrounded by water; potentially multiple layers) → criticality
- T1.3: Water surrounding the array of canisters, with simultaneous water ingress at optimal moderator-to-fuel ratio → criticality
- T1.4: Low ambient temperatures → criticality at low temperatures
- T1.5: Damage to container resulting from drop → reduced container array spacing → criticality
- T1.6: Loss of overpack resulting from vehicle accident → reduced container array spacing → criticality



Figure 14. ES-3100 Type B shipping container [7].

### Release/Shielding

- T2.7: Corrosion of sodium bond
- T2.8: Water ingress in canister → violent reaction with sodium bond in the fuel element
- T2.9: Fire resulting from vehicle accident and bonded sodium release (from fuel element) → respiratory burns caused by sodium release in atmosphere after fire
- T2.10: Incorrect closure of cask → increased source/dose to worker or public during transport

### 5.5 HPR FUEL ASSEMBLY TRANSPORTATION

A transportation cask has not been identified to carry the HPR fuel, but there are two possible alternatives. One is the ES-3100, as discussed in Section 5.4. The other option would be in a cask similar to the NAC-LWT, which is much larger and can accommodate the HPR fuel elements.

The NAC-LWT is a steel-encased, lead-shielded shipping cask (see Figure 15). The cask is designed to transport various radioactive contents and includes a neutron shield. The overall dimensions of the package, with aluminum honeycomb impact limiters, are 589 cm long by 165 cm in diameter. The volume of the cavity is approximately 410 liters. The NAC-LWT is certified for transportation of a variety of fuel rods and assemblies, including spent boiling water reactor (BWR) and PWR fuel, and metallic fuel rods containing natural enrichment uranium pellets with aluminum cladding. The loading and enrichment level is dependent on the individual certified fuel types.

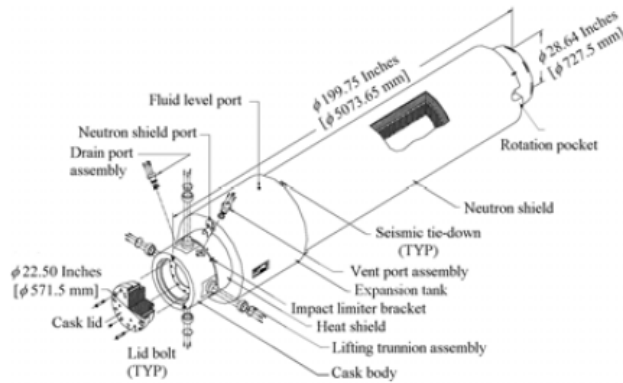


Figure 15. NAC-LWT shipping container [9].

### Criticality

- T1.1: Water surrounding array of canisters at optimal moderator-to-fuel ratio and optimal canister → criticality
- T1.2: Water ingress into array of canisters at optimal moderator-to-fuel ratio (consider homogeneous sphere of  $UF_6$  and water, surrounded by water; potentially multiple layers) → criticality
- T1.3: Water surrounding the array of canisters with simultaneous water ingress at optimal moderator-to-fuel ratio → criticality
- T1.4: Low ambient temperatures → criticality at low temperatures
- T1.5: Damage to container resulting from drop → reduced container array spacing → criticality
- T1.6: Loss of overpack resulting from vehicle accident → reduced container array spacing → criticality

### Release

- T2.7: Fire resulting from vehicle accident → fire of fuel elements

### 5.6 REFERENCES

- [1] J. Anderson, M. Goins, P. Paul, A. Wilkinson, and D. Wilson. *Safety Analysis Report for Packaging, Y-12 National Security Complex, Model ES-3100 Package with Bulk HEU Contents*. Technical Report SP-PKG-801940-A001, Rev. 1, Docket No. 14-18-9315; TRN: US1900659, Consolidated Nuclear Security, Y-12 National Security Complex and Pantex Plant, 2015. URL: <https://www.osti.gov/servlets/purl/1412793>.
- [2] ANSI. *Uranium Hexafluoride—Packaging for Transport*. Technical Report N14.1-2001, ANSI, 2001. URL: <https://law.resource.org/pub/us/cfr/ibr/002/ansi.n14.1.2001.pdf>.
- [3] Daher-TLI. *Versa-Pac Safety Analysis Report*. Technical Report Docket No. 71-9342, Daher-TLI, Oak Ridge, TN, 2018. URL: <https://www.nrc.gov/docs/ML1833/ML18330A093.pdf>.
- [4] R. A. Hall, W. J. Marshall, E. Eidelpes, and B. M. Hom. *Assessment of Critical Experiment Benchmark Applicability to a Large-Capacity HALEU Transportation Package Concept*. *Nuclear Science and Engineering*, 195(3):310–319, 2021. doi:10.1080/00295639.2020.1801319.



- [5] P. Honnold, L. Crabtree, M. Higgins, A. Williams, B. Finch, B. Cipiti, D. Ammerman, C. Farnum, and E. Kalinina. *PRO-X Fuel Cycle Transportation and Crosscutting Progress Report*. Technical Report SAND2022-13387R, Sandia National Laboratories, Albuquerque, NM, 2022. URL: <https://www.osti.gov/servlets/purl/1890069>.
- [6] IAEA. *Regulations for the Safe Transport of Radioactive Material*. Technical Report SSR-6 (Rev. 1), International Atomic Energy Agency, Vienna, Austria, 2018. URL: <https://www.iaea.org/publications/12288/regulations-for-the-safe-transport-of-radioactive-material>.
- [7] J. Jarrell. *A Proposed Path Forward for Transportation of High-Assay Low-Enriched Uranium*. Technical Report INL/EXT-18-51518, Idaho National Laboratory, Idaho Falls, ID, 2018. URL: [https://inldigitallibrary.inl.gov/sites/sti/sti/Sort\\_19856.pdf](https://inldigitallibrary.inl.gov/sites/sti/sti/Sort_19856.pdf).
- [8] D. Kovacic, P. Gibbs, L. Worrall, R. Hunneke, J. Harp, and J. Hu. *Advanced Reactor Safeguards: Nuclear Material Control and Accounting for Pebble Bed Reactors*. Technical Report ORNL/SPR-2020/1849, Oak Ridge National Laboratory, Oak Ridge, TN, 2021. URL: [https://gain.inl.gov/SiteAssets/2021-April\\_SafeguardsAndSecurityWorkshop/Reading/Advanced%20Reactor%20Safeguards%20-%20Nuclear%20Material%20Control%20and%20Accounting%20for%20Pebble%20Bed%20Reactors.pdf](https://gain.inl.gov/SiteAssets/2021-April_SafeguardsAndSecurityWorkshop/Reading/Advanced%20Reactor%20Safeguards%20-%20Nuclear%20Material%20Control%20and%20Accounting%20for%20Pebble%20Bed%20Reactors.pdf).
- [9] Y. Liu, V. Shah, R. Fabian, and J. Shuler. Certification of the NAC-LWT Cask for Shipment of Sodium Debris Bed Experiments. In *2008 ASME Pressure Vessels and Piping Division Conference*. American Society of Mechanical Engineers, 2008. URL: <https://asmedigitalcollection.asme.org/PVP/proceedings/PVP2008/48302/623/330686>.
- [10] J. McFarlane, P. Taylor, D. Holcomb, and W. P. Poore. *Review of Hazards Associated with Molten Salt Reactor Fuel Processing Operations*. Technical Report ORNL/TM-2019/1195, Oak Ridge National Laboratory, Oak Ridge, TN, 2019. URL: <https://info.ornl.gov/sites/publications/Files/Pub126864.pdf>.
- [11] US NRC. *10 CFR Part 71, Packaging and Transportation of Radioactive Materials*. <https://www.nrc.gov/reading-rm/doc-collections/cfr/part071/index.html>, 2023. Accessed: 2023-01-06.
- [12] Orano. *DN30 Package*. <https://orano-ncs.com/en/dn30-package/>. Accessed: 2023-01-05.
- [13] Orano. *Safety Analysis Report for the DN30-X Package*. Technical Report 0045-BSH-2020-001 Rev. 3, Orano, Hanau, Germany, 2022. URL: <https://www.nrc.gov/docs/ML2232/ML22327A183.pdf>.
- [14] D. A. Reed. *Application Areas of Potential Challenge to Nuclear Criticality Safety Margins for Future High Temperature Gas Reactor Fuel Cycle Activities*. Technical Report ORNL/LTR-2011/79, Oak Ridge National Laboratory, Oak Ridge, TN, 2011. URL: <https://www.osti.gov/biblio/1969839>.
- [15] E. Saylor, A. Lang, B.J. Marshall, and B. Hall. *Analysis of the 30B UF6 Container for Use with Increased Enrichment*. Technical Report ORNL/TM-2021/2043, Oak Ridge National Laboratory, Oak Ridge, TN, 2021. URL: <https://www.osti.gov/servlets/purl/1797631/>.
- [16] US NRC. *Certificate of Compliance for Radioactive Material Packages*. Technical Report NRC FORM 618, Certificate number 9288, US Nuclear Regulatory Commission, Rockville, MD. URL: <https://rampac.energy.gov/docs/default-source/certificates/1019288.pdf>.
- [17] US NRC. *Certificate of Compliance for Radioactive Material Packages*. Technical Report NRC FORM 618, Certificate number 9315, US Nuclear Regulatory Commission, Rockville, MD. URL: <https://www.nrc.gov/docs/ML0913/ML091310143.pdf>.



- [18] US NRC. *Certificate of Compliance for Radioactive Material Packages*. Technical Report NRC FORM 618, Certificate number 9342, US Nuclear Regulatory Commission, Rockville, MD, 2018. URL: <https://rampac.energy.gov/docs/default-source/certificates/1019342.pdf>.
- [19] US NRC. *Certificate of Compliance for Radioactive Material Packages*. Technical Report NRC FORM 618, Certificate number 9388, US Nuclear Regulatory Commission, Rockville, MD, 2023. URL: <https://rampac.energy.gov/docs/default-source/certificates/1019388.pdf>.

## 6. HIGH TEMPERATURE GAS-COOLED REACTOR

The pebble-bed HTGR fuel cycle poses unique issues compared to the traditional LWR fuel cycle and other fuel cycles studied for the Volume 5 task. With respect to the fuel, these issues include the fuel components in the form of TRISO particles in fuel pebbles, higher enrichment of the uranium dioxide or uranium oxycarbide, and fuel pebbles at high burnup. These issues are especially relevant and differ from other fuel cycles with respect to transportation and storage of fresh and spent fuel pebbles. For fuel utilization stages, the continuous operation of HTGRs involving the continuous removal of depleted fuel pebbles and the addition of fresh fuel pebbles bring new challenges. Furthermore, the high pressure and temperature of the helium coolant must be considered.

The PBMR-400 international reactor physics benchmark [4, 7] was chosen as basis for development of the HTGR fuel cycle (Figure 16). Information about spent fuel storage is included in other resources [3, 10]. Further HTGR references, including documentation of the limited operating experience with HTGRs, were studied to develop comprehensive lists of potential accident scenarios for the different utilization stages [1, 2, 5, 6, 8, 9, 11]. Fuel enrichment, TRISO particle fabrication, fuel pebble fabrication, and transportation of enriched  $UF_6$  and fuel pebbles are considered in previous sections (Sections 2, 4, and 5).

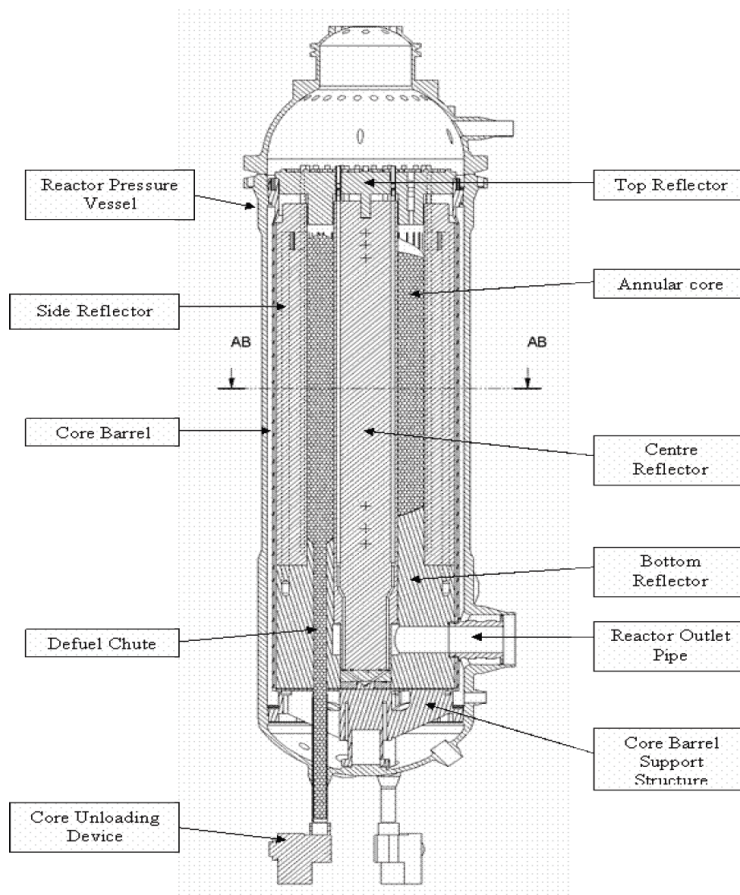


Figure 16. Schematic of the PBMR-400 reactor core [7].

## 6.1 PLANT AND OPERATION DESCRIPTION

The PBMR-400 is a modular helium-cooled 400 MWth HTGR that was originally considered for development by the South African utility ESKOM as part of a larger industrial consortium, PBMR Ltd., which also included the South African Government and British Nuclear Fuel [4]. Its annular core is filled with approximately 452,000 fuel pebbles, and the core is contained in graphite reflector structures. Gravity-driven, the pebbles travel from the top of the core to the bottom. On average, a fuel pebble completes 6 passes through the core before reaching its final discharge burnup of 90 GWd/tHM. A fuel pebble contains a fuel zone in which TRISO particles are distributed in a graphite matrix; the fuel zone is surrounded by a graphite shell. The PBMR-400 pebbles contain an average of 15,000 TRISO particles, which corresponds to ~9 g U per pebble. The fuel zone is a sphere of 5 cm diameter covered by 0.5 cm thick graphite shell to yield a total diameter of 6 cm. The fuel material is UO<sub>2</sub>, with an enrichment of 9.6 wt% <sup>235</sup>U. The helium coolant is circulated at a rate of 192.7 kg/s with an outlet pressure of 9 MPa. Core inlet and outlet temperatures are approximately 500°C and 900°C, respectively, and the fuel temperature is approximately 840°C. Reactivity control is achieved using control rods and blades containing boron carbide. Heat removal is performed through a high-efficiency Brayton cycle.

For most of the plant's lifetime, it is being operated at a state of equilibrium during which fuel pebbles are continuously added and removed from the core such that the average fuel inventory in each core region remains approximately the same. At each point in time during operation at equilibrium, a mixture of fuel pebbles at different passes (passes 1 through 6) are contained in the core. Depending on the accumulated burnup, a fuel pebble is either reinserted into the core for another pass, or it is discharged. A pebble accumulates approximately 2.6 years of residence time at full power operation before reaching the final burnup of 90 GWd/tHM.

The PBMR-400 start-up core consists of 2/3 graphite pebbles and 1/3 fuel pebbles at a lower enrichment of 5.768 wt% <sup>235</sup>U. During equilibrium operation, it is assumed that the core consists of a mixture of fuel pebbles at different burnups but that there are no graphite pebbles in the core. Because the running-in phase, during which the core slowly reaches equilibrium, can take years, graphite pebbles are considered in the listed accident scenarios. For the purpose of this fuel cycle and the efforts in this project, it is assumed that the graphite pebbles are continuously circulated and not replaced, although in the actual reactor operation, the graphite pebbles would be replaced if they are damaged.

Note that different reports show slightly different values for the number of pebbles in the reactor core, the number of circulated pebbles per day, and so on. Because of these discrepancies and differences in various HTGR designs, a range of enrichments and different target burnups are considered in the actual calculations in this report.

## 6.2 ACCIDENT SCENARIOS

### 6.2.1 FRESH FUEL PEBBLE STAGING AND LOADING

Because no other information is available, it is assumed that the fresh fuel pebbles are stored in their Versa-Pac transportation canisters (see Section 5.2). The pebbles are fed into the system via hoppers so that they enter one-by-one the fuel handling and storage system (FHSS). During the start-up phase, additional graphite pebbles are stored in fuel handling areas.

The potential scenarios for the U1 stage are limited to criticality accidents related to the storage and handling of fresh fuel pebbles.

## Criticality

- U1.1: Water surrounding array of canisters at optimal moderator-to-fuel ratio and optimal canister → criticality
- U1.2: Water ingress into array of canisters at optimal moderator-to-fuel ratio → criticality
- U1.3: Water surrounding into array of canisters with simultaneous water ingress at optimal moderator-to-fuel ratio → criticality
- U1.4: Misplacement of array of graphite pebble and fuel pebble containers → additional moderation caused by graphite moderator → criticality
- U1.5: Damage to container resulting from drop of container → reduced container array spacing → criticality
- U1.6: Fire in pebble handling chamber → fire of fuel pebble graphite
- U1.7: Fire in pebble handling chamber → extinguishing water contacts graphite at high temperature → graphite corrosion and development of graphite dust
- U1.8: Dropped pebbles while filling into hopper → damaged pebbles → generation of graphite dust

## 6.2.2 POWER PRODUCTION

The FHSS performs all the required fuel manipulations during the entire life cycle of the PBMR-400, loading and unloading pebbles into and from the reactor core while the reactor is operating at power. During startup, the FHSS is loading the core with graphite and fuel pebbles, and during the running-in phase, it gradually changes the core content from the graphite/fuel pebble mixture to fuel pebbles only. The FHSS is a closed system which operates at 1–9 MPa pressure and at 20–260°C. The pebbles are removed from the core via a core unloading device (CUD). The pebbles then travel through pipes (Figure 17) and are lifted to the top of the reactor through pneumatic pressure and other means. Approximately 2,900 pebbles are removed from the core per day, and approximately 483 pebbles are consumed and discharged per day and are not reinserted. Over the course of the plant's 40-year lifetime, with a 30-day overhaul every 6 years, approximately 7 million fuel pebbles are consumed.

Each pebble that leaves the reactor is checked for its integrity, and then broken or damaged spheres are separated. For intact pebbles, the fuel pebble burnup is measured in the burnup measurement and sorting system (BUMS) via high-purity germanium detector to perform gamma spectroscopy to measure  $^{137}\text{Cs}$  inventory. The challenge for the gamma spectroscopy is the presence of gamma peaks neighboring the prominent 661.6 keV  $^{137}\text{Cs}$  peak and the Compton scattering background. This can be mitigated by letting short-lived isotopes sufficiently decay before measurement. The accuracy of the BUMS depends on how long short-lived isotopes were able to decay to reduce background noise and how long the actual measurement is performed.

Potential scenarios for the U2 stage cover criticality, heat removal, and release scenarios during fuel pebble loading into the FHSS, circulation of pebbles in the pipes, insertion into and removal of pebbles from the core, fuel pebble burnup measurement, and other scenarios during operation.

## Criticality

- U2.1: Failure in FHSS system → additional pebbles enter core → criticality
- U2.2: Failure in BUMS → pebbles with low burnup replaced by fresh pebbles → too many fresh fuel pebbles enter the core → criticality

- U2.3: Failure in CUD → pebbles are not removed from reactor but are still added on top → criticality
- U2.4: Seismic events → reorientation of pebbles (consider pebble cone in upper core) → criticality
- U2.5: Water steam ingress into core without CR insertion → criticality

### **Release**

- U2.6: FHSS pipe rupture → Pebbles come out of the reactor at high temperature and pressure → oxidation of graphite in contact with air → pebble damage with fission product release
- U2.6: Fission products escaped from pebbles adsorb into graphite dust (dust generated by pebble wear, fracture, irradiation sputtering, and corrosion) → graphite dust flows in the primary circuit with the helium and deposits on the surface of the reactor components → loss of coolant causes release of dust-gas mixture, leading to fission product release
- U2.7: Air ingress into core
- U2.8: Chemical attack of TRISO layers and graphite (by steam) → graphite oxidation
- U2.9: Graphite dust catches fire from sparks or heat
- U2.10: Broken pebble gets stuck in reactor → fission product release into He coolant

### **Heat removal**

- U2.11: Accumulation of hot pebbles in FHSS pipes at high temperatures and pressure (“pebble jam”) caused by error in FHSS or stuck pebbles resulting from a damaged or swollen pebble → temperature increase
- U2.12: Depressurized loss of forced circulation (covered in Vol.3)
- U2.13: Blockage of fuel element coolant channel resulting from graphite failure/spalling (channel distortion) → temperature increase → fuel pebble failure

## **6.2.3 ON-SITE DRY CASK STORAGE**

If the BUMS determines that a fuel pebble has reached its maximum burnup, then the FHSS is moving the pebble into spent fuel container. The PBMR-400 concept plans for 10 spent fuel containers that each can take 620,000 pebbles (Figure 18 and Figure 19). These 10 spent fuel containers can contain the spent fuel pebbles from the reactor’s entire lifetime. These containers are planned to serve as interim storage for up to 80 years (40 years of reactor operation + 40 years of additional onsite storage).

Additionally, there is one graphite storage tank that is used to store the graphite pebbles from the startup core, and there is one used fuel tank that can store all fuel pebbles from the core during maintenance, reflector replacement, and so on. The used fuel tank has, on average, less burnup than the spent fuel container because the latter only contains fuel pebbles with burnup levels around the target discharge burnup.

The potential scenarios for the U4 stage cover criticality, heat removal and release scenarios during loading of pebbles into spent fuel containers and during handling and storage of spent fuel tanks.

### **Criticality**

- U4.1: Graphite pebbles are misloaded into fuel pebble storage → criticality
- U4.2: BUMS malfunction → pebbles with lower burnup than discharge burnup are misloaded into fuel pebble storage → criticality
- U4.3: Water ingress into used fuel tank → criticality

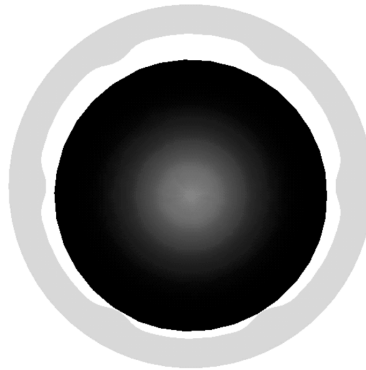


Figure 17. PBMR-400 fuel pebble within a pipe for pebble transfer within the fuel handling and storage system [9].

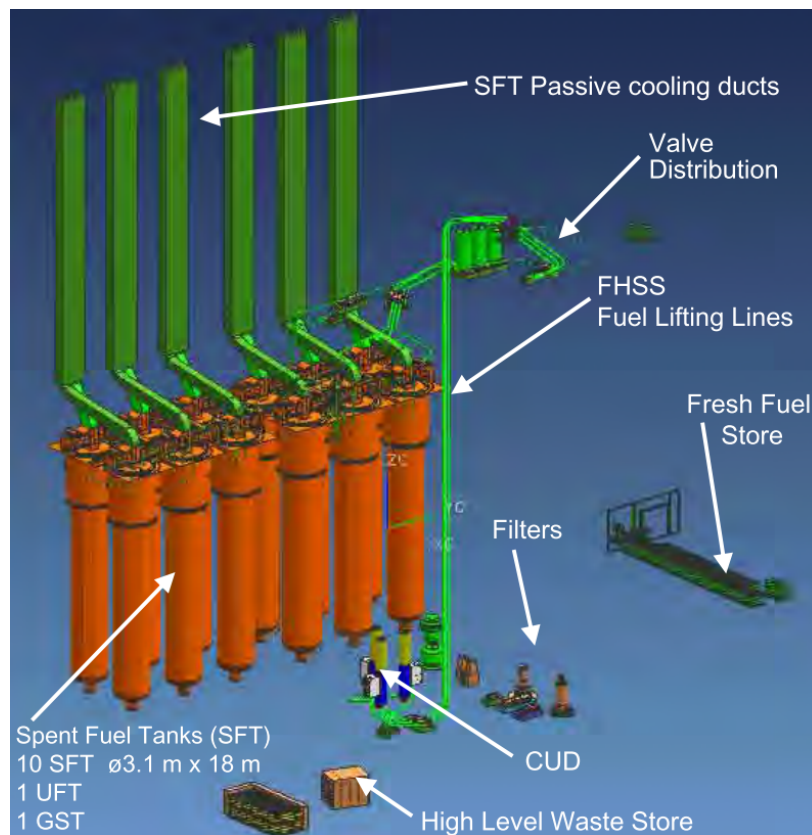
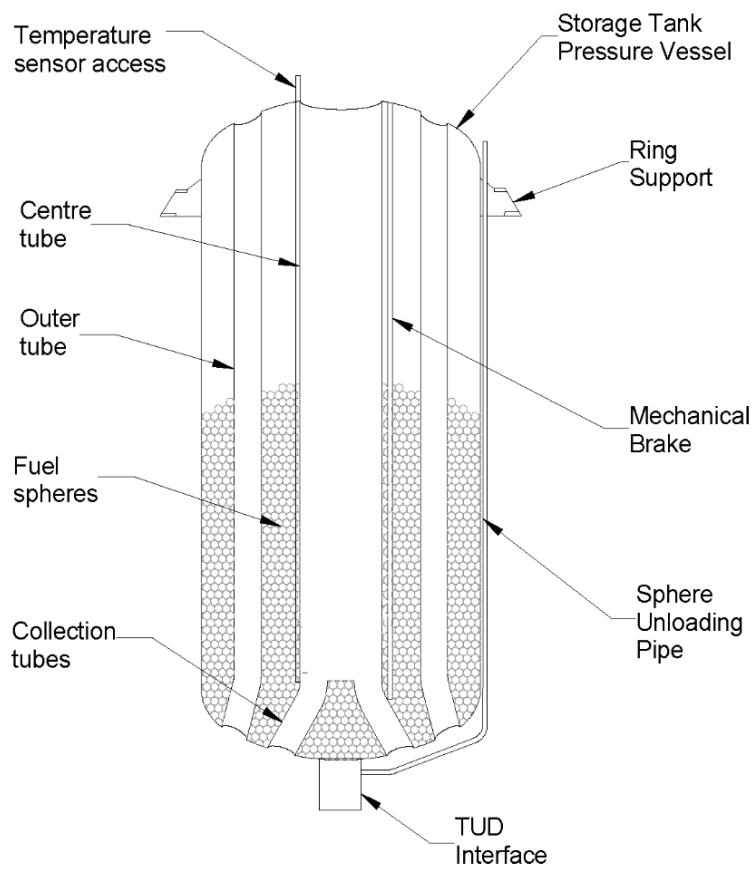


Figure 18. PBMR-400 spent fuel storage tanks as part of the FHSS [9].



**Figure 19. PBMR-400 spent fuel storage tank [10].**



- U4.4: Tank rupture with no tube collapse → reorientation of pebbles → criticality
- U4.5: Tank rupture with central tube collapse → reorientation of pebbles → criticality

### Heat removal

- U4.6: BUMS malfunction → pebbles with higher burnup than discharge burnup are misloaded into fuel pebble storage → increased temperature from decay heat
- U4.7: Failure of the active cooling system → passive cooling system takes over through natural convection → slightly higher fuel and structure temperatures
- U4.8: Failure of the passive cooling system because of blockage of the natural convection paths → high temperature increase of fuel and structure
- U4.9: Dropping of pebbles within the FHSS → damage of fuel pebbles → pebble jammed → insufficient cooling

### Release

- U4.10: Manufacturing defects of fuel pebbles → release of fission products from defective pebbles
- U4.11: Dropping of pebbles within the FHSS → damage of fuel pebbles → fission product release and graphite dust
- U4.12: Dropping of pebbles inside the storage tank → damage of fuel pebbles → fission product release and graphite dust
- U4.13: Tank rupture with no tube collapse → damage of fuel pebbles → fission product release and graphite dust
- U4.14: Tank rupture with central tube collapse → damage of fuel pebbles → fission product release and graphite dust
- U4.15: Gamma radiation from fuel pebbles causing radiolysis of the air → extremely corrosive elements such as nitric acid and ozone in the air → graphite corrosion → fuel pebble failure → fission product release
- U4.16: Sparks from machinery, equipment, electrical circuits, or human activities → fire
- U4.17: Radiolysis of the coolant air → evolution of explosive gas mixtures → explosion
- U4.18: Off-gassing or volatilization → evolution of explosive gas mixtures → explosion
- U4.19: Collision of vehicles or suspended loads with FHSS pipes → pipe rupture → pebble drop → fission product release and graphite dust
- U4.22: Collision of vehicles or suspended loads with storage tank → damage to tank → damage to pebbles inside tank → fission product release and graphite dust

## 6.3 REFERENCES

- [1] S. J. Ball and S. E. Fisher. *Next Generation Nuclear Plant Phenomena Identification and Ranking Tables (PIRTs) Volume 1: Main Report*. Technical Report NUREG/CR-6944, Vol. 1, ORNL/TM-2007/147, Vol. 1, Oak Ridge National Laboratory, Oak Ridge, TN, 2008. URL: <https://www.nrc.gov/docs/ML0811/ML081140459.pdf>.



- [2] P. C. Durst, D. L. Moses, D. Beddingfield, B. Boyer, R. Bean, and M. Collins. *Nuclear Safeguards Considerations for the Pebble Bed Modular Reactor ( PBMR ) Bed Modular Reactor (PBMR)*. Technical Report INL/EXT-09-16782, Idaho National Laboratory, Idaho Falls, ID, 2009. URL: <https://inldigitalibrary.inl.gov/sites/sti/sti/4374060.pdf>.
- [3] W. F. Fuls, C. Viljoen, C. Stoker, C. Koch, and M. Kleingeld. The Interim Fuel Storage Facility of the PBMR. *Annals of Nuclear Energy*, 32(17):1854–1866, 2005. doi:10.1016/j.anucene.2005.05.006.
- [4] IAEA. *Evaluation of High Temperature Gas Cooled Reactor Performance: Benchmark Analysis Related to the PBMR-400, PBMM, GT-MHR, HTR-10 and the ASTRA Critical Facility*. Technical Report IAEA-TECDOC-1694, International Atomic Energy Agency, 2013. URL: [https://www-pub.iaea.org/MTCD/Publications/PDF/TE-1694\\_{\\_}web.pdf](https://www-pub.iaea.org/MTCD/Publications/PDF/TE-1694_{_}web.pdf).
- [5] IAEA. *Storage of Spent Nuclear Fuel*. Technical Report Specific Safety Guide No. SSG-15 (Rev. 1), International Atomic Energy Agency, Vienna, Austria, 2020. URL: [https://www-pub.iaea.org/MTCD/Publications/PDF/P1882\\_web.pdf](https://www-pub.iaea.org/MTCD/Publications/PDF/P1882_web.pdf).
- [6] X. Luo, X. Wang, L. Shi, X. Yu, and S. Yu. Nuclear Graphite Wear Properties and Estimation of Graphite Dust Production in HTR-10. *Nuclear Engineering and Design*, 315:35–41, 2017. doi:10.1016/j.nucengdes.2017.02.016.
- [7] NEA. *PBMR Coupled Neutronics/Thermal-hydraulics Transient Benchmark, The PBMR-400 Core Design - Volume 1: The Benchmark Definition*. Technical Report NEA/NSC/DOC(2013)10, OECD/NEA, 2013. URL: [https://www.oecd-nea.org/jcms/pl\\_{\\_}19318/pbmr-coupled-neutronics/thermal-hydraulics-transient-benchmark-the-pbmr-400-core-design-volume-1-the-benchmark-definition](https://www.oecd-nea.org/jcms/pl_{_}19318/pbmr-coupled-neutronics/thermal-hydraulics-transient-benchmark-the-pbmr-400-core-design-volume-1-the-benchmark-definition).
- [8] D. A. Reed. *Application Areas of Potential Challenge to Nuclear Criticality Safety Margins for Future High Temperature Gas Reactor Fuel Cycle Activities*. Technical Report ORNL/LTR-2011/79, Oak Ridge National Laboratory, Oak Ridge, TN, 2011. URL: <https://www.osti.gov/biblio/1969839>.
- [9] J. Slabber. *Reactor Unit and Main Support Systems*. <https://www.nrc.gov/docs/ML0606/ML060680079.pdf>, 2006.
- [10] C. C. Stoker and F. Reitsma. *PBMR Used Fuel Storage Criticality for Most Reactive Core Loading*. In *8th International Conference on Nuclear Criticality Safety (ICNC), St. Petersburg, Russia, 28 May–1 June*, pages 8–14, 2007.
- [11] P. Venter. *HTGR Technology Course for the Nuclear Regulatory Commission, Module 6d*. <https://art.inl.gov/NGNP/Training%20Modules%20%20HTGR%20Fundamentals/Module%206d%20-%20Pebble%20Bed%20HTGR%20Refueling%20Design.pdf>, 2010.

## 7. MOLTEN SALT-FUELED REACTOR

The MSR fuel cycle poses unique issues beyond those posed by the traditional LWR fuel cycle and other fuel cycles studied for the Volume 5 task. With respect to the fuel, these issues include the synthesis, transportation, and storage in the form of fuel salt. For the fuel utilization stages, the continuous operation of MSRs involving the online refueling, the fission and decay products generated and contained in the fuel salt, and online fission product removal introduce new challenges. The use molten coolant salt also introduces issues because of the generation of tritium from the common salt component Li and because of the salt's reactivity with water, air, and concrete in case of salt spills. Finally, storage of various waste products from the salt analysis, filtering, off-gas system, and so on, requires additional consideration.

The thermal-spectrum MSRE [8] was chosen as the basis for development of the MSR fuel cycle because it provides one of the limited experimental data sets. However, other salts and more recent developments for topics such as fission product removal through the off-gas system are also considered. Two reports serve as major resources when identifying accident scenarios for the MSR fuel cycle. These reports address phenomena and hazards associated with MSRs prepared by ORNL [5,6]. Other relevant references inform the general MSR fuel cycle and address potential issues [3,4,9]. Major information on the preparation and handling of salt and on spent fuel salt was obtained from the literature [7,10], and considerations about the off-gas system are described in detail in Andrews et al. [1]. Fuel enrichment, fuel salt synthesis, and transportation of enriched UF<sub>6</sub> and fuel salt are considered in previous sections (Sections 2, 4, and 5).

### 7.1 PLANT AND OPERATION DESCRIPTION

MSR design choices under current discussion vary widely. Besides the utilization of different fuel salt compositions and the operation with a thermal spectrum vs. a fast neutron spectrum, some MSRs have the potential to use spent fuel, and some MSRs could allow for actinide recovery from the fuel salt. In general, the fuel salt is a mixture of fissile and carrier salt (see Section 4.3). Additionally, some fast spectrum MSRs use blanket salts that can serve for breeding. For the fissile salt, two major classes can be distinguished: fluoride salts that are mostly proposed for thermal spectrum MSRs, and chloride salts that are mostly proposed for fast spectrum MSRs.

#### Thermal-spectrum MSR

Figure 20 shows a general flowchart of a thermal-spectrum MSR system. The fuel salt is circulated through the primary salt pump through the loop and the reactor vessel. The vessel contains a large graphite structure for neutron moderation. While passing through the reactor core, fission causes the addition of fission products to the fuel salt and leads to salt temperature increase. Outside the reactor, fission and activation products in the fuel salt decay. A fraction of gaseous fission products—mostly noble gases—are removed through the off-gas system. Noble metals plate out over time at structural surfaces. A freeze valve or plug allows for the intentional or unintentional (e.g., a power loss leading to loss of salt cooling in the valve) draining of the salt into tanks. Refueling is performed by adding fuel salt to the salt in the loop. Chemistry control of the fuel salt plays a major role in MSRs for managing the salt's redox potential and avoiding corrosion.

#### Fast-spectrum MSR

Many components in the loop of a fast spectrum MSR are similar to those in the thermal spectrum MSR. The makeup fuel that is used for refueling is different because fast spectrum systems can use depleted or natural uranium which is transmuted to fissile plutonium during operation. Fast spectrum MSRs naturally do not contain a moderator.

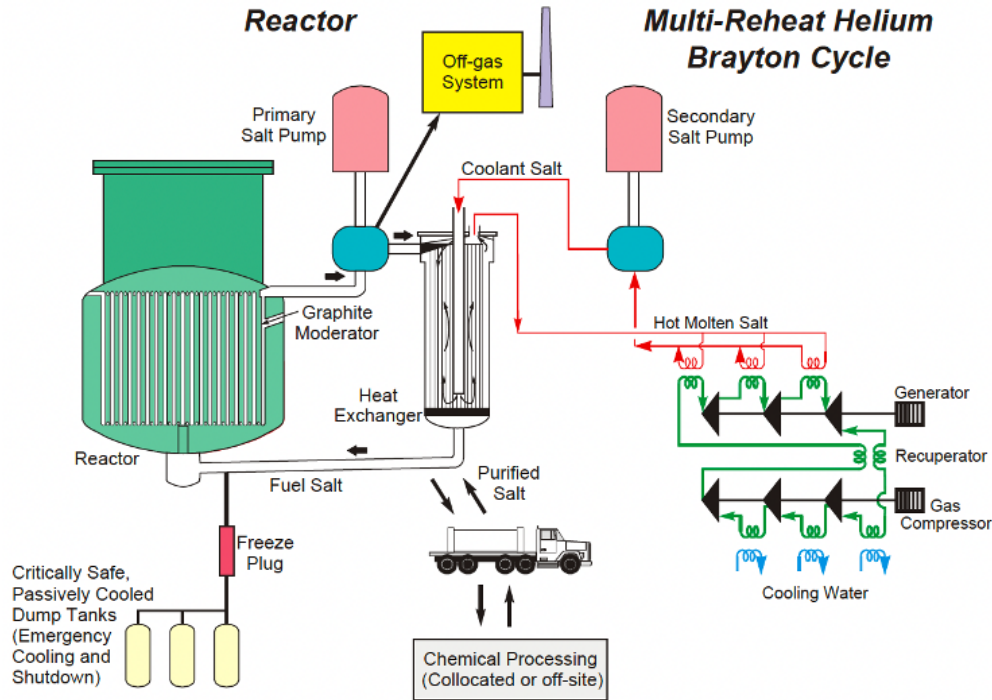


Figure 20. Thermal spectrum MSR [2].

## MSRE

The MSRE was the first large-scale, long-term, high-temperature experiment performed using a fluid fuel salt, a graphite moderator, and new nickel-based alloys in a reactor environment [8]. The circulating fuel was a mixture of lithium, beryllium, and zirconium fluoride salts containing uranium fluorides. Reactor heat was transferred from the fuel salt to a coolant salt and was then dissipated to the atmosphere. The MSRE was designed to provide a thermal output of 10 MWth. The reactor reached criticality for the first time in June of 1965 and was operated until 1969. The MSRE was initially operated using  $^{235}\text{U}$  and was later switched to  $^{233}\text{U}$ .

Designed as an experiment, the MSRE used a small core with a volume of less than  $2\text{ m}^3$  that was not made for continuous operation or power generation. It contained 2,067 liters of operational fuel salt and employed a fuel salt pump with a flow rate of 1,200 gpm. The temperature of the fuel salt temperature as it exited the core was approximately  $660^\circ\text{C}$ .

The starting core contained fuel salt that was separately synthesized and incrementally dissolved into carrier salt to start and maintain nuclear operation. Later, during operation, a sampler-enricher mechanism was used: solid salt contained in Ni capsules was inserted into the bulk salt from which the salt dissolved into the bulk salt for enrichment (148 g salt per capsule, up to 90 g  $^{235}\text{U}$  per capsule). The fuel salt was processed off line in batches. The MSRE used a Brayton power cycle.

## 7.2 FUEL SALT CONDITIONING, MIXING, AND LOADING

Current literature does not specify whether the fissile and carrier salts are mixed at the reactor site or at the facility that synthesizes the salt. Given the greater challenges posed by transporting fissile material, it is reasonable to assume that there is interest in minimizing the volume of fissile material to be transported.

Therefore, it is assumed here that the fissile and carrier salts would be transported separately and mixed at the reactor site. Therefore, storage will be required for containers of these two salts.

In the MSRE, the carrier salt was first mixed with the depleted fuel salt mixture, after which enriched fuel salt was added in batches to increase the fissile salt fraction [8]. A similar approach that involves the gradual addition of fissile salt to the carrier salt is assumed here.

Before being introduced into the fuel salt circuit, the salt will be melted. At the start of the MSR, a large amount of salt will be melted. In contrast, during operation, only small amounts of additional fuel salt will require conditioning and melting for refueling. The salt does not have an energetic chemical reaction with water or air, but it is hygroscopic and readily contaminated when exposed to air.

The conditioning of the fuel salt will involve removal of residual oxygen, sulfur, and metal impurities [10]:

- Oxygen in salt is mainly the result of incomplete evaporation of absorbed water. It can be removed via gas sparging of the molten fluoride melt with anhydrous hydrogen fluoride (oxygen removed as water vapor). The removal of oxygen avoids the buildup of  $\text{UO}_2$  which is relevant because  $\text{UO}_2$  clusters would cause poor heat transfer, and the deposition of  $\text{UO}_2$  in the loop would lead to localized heat sources.
- Sulfur impurities can be found mainly as sulfates. There are a number of alternate HF- $\text{H}_2$  sparge treatments in which sulfates are reduced to sulfide ion which reacts with HF to form volatile  $\text{H}_2\text{S}$  which is then removed. Sulfur must be removed to avoid corrosion of Ni-based alloys that are used for structural components at elevated temperatures.
- Structural-metal impurities are present in the raw materials or are introduced by corrosion of the process equipment during production operations. The removal of these impurities is necessary to avoid excessive corrosion of Ni-based alloys if structural-metal fluorides at nonequilibrium concentration are contained in the molten salt.

### 7.3 POWER PRODUCTION WITH ONLINE CHEMICAL PROCESSING

MSRs operate at just above atmospheric pressure and at temperatures above the salt's melting points, typically  $\leq 650^\circ\text{C}$ . Off-normal events can have higher temperatures of  $\leq 800^\circ\text{C}$ , for example. Unlike reactors with static fuel, MSRs do not consider excess reactivity at the beginning of operation, but they operate with the reactivity necessary for current operation with (semi)continuous refueling. In burner reactors, makeup fuel salt is added during operation. In breeder reactors, fertile blanket salt is processed, and plutonium is added into the fissile salt. For structural materials, mainly Ni-based alloys such as Alloy N/Hastelloy N/INOR-8 have been considered for the reactor vessel and pipes. Other materials such as continuous fiber ceramic composites (e.g., SiC) are also under discussion. Given the high operating temperatures, thermally activated processes such as corrosion and creep must be considered for material selection.

Relevant components for the operation of an MSR are as follows:

- Cover-gas system (He, Ar): salt vapors, mists, and aerosols released from the fuel  $\rightarrow$  substantial thermal energy, requiring heat removal
- Off-gas system: noble gas fission products escape fuel and are removed (Figure 21)
- Emergency systems drain tank with freeze valve
- Fuel salt storage tank for intermediate storage during maintenance
- Fuel salt chemistry monitoring: maintain the appropriate fluorine or chlorine (redox) potential to prevent material corrosion (e.g., keep correct ratio of  $\text{UF}_4/\text{UF}_3$  or  $\text{UCl}_4/\text{UCl}_3$ )

Besides the generation of fission products that are transported together with the salt and from which some gaseous fission products are removed in the off-gas system, other relevant phenomena occurring in the salt are the plating out of noble metal and tritium generation. Noble metal fission products plate out over time onto structures (in particular, the heat exchanger) or precipitate from the fuel salt. This can impact heat removal and local activity.

In the case of thermal spectrum MSR that use Flibe salt, using F, Li, and Be in the coolant causes MSR to produce considerable quantities of tritium. While the reduction of the  $^6\text{Li}$  concentration, i.e. the enrichment of Li to high amounts of  $^7\text{Li}$ , can reduce the tritium generation, tritium generation cannot be completely avoided since it is produced through  $^6\text{Li}$ ,  $^7\text{Li}$ , and  $^{19}\text{F}$  (see Section 8.1.2 for additional details). As a low-energy beta emitter, tritium is a health hazard when ingested or absorbed through the skin (e.g., via tritiated water HTO). Therefore, the generation and release paths of tritium must be understood and avoided. Tritium generated in the salt can be carried along and is transported to different surfaces in the reactor (core structures, heat exchangers, pipes, etc.). Different reactions of tritium (corrosion, adsorption, permeation, etc.) may occur at these surfaces, thus requiring management of tritium by providing sufficient tritium absorption and preventing tritium released via permeation through surfaces such as the thin surfaces of the heat exchanger.

In the case of fast spectrum MSR that use chloride salt, the generation of  $^{36}\text{Cl}$  through neutron absorption in  $^{35}\text{Cl}$  should be avoided because  $^{36}\text{Cl}$  has a long half-life and significantly increases radiotoxicity of the fuel salt. Chlorine has two naturally occurring isotopes,  $^{35}\text{Cl}$  and  $^{37}\text{Cl}$  at 76% and 24% abundances, respectively. Proposed MSR that use chloride salt therefore consider enriching the chlorine to  $^{37}\text{Cl}$  to remove  $^{35}\text{Cl}$ .

Leaks or breaks in the reactor vessel or pipes are especially relevant, because if salt is reaching the concrete floor, then a hot liquid fuel salt – concrete reaction can occur that leads to the release of bound water and production of hydrogen from the concrete. In concrete with fine pores, which is already  $200^\circ\text{C}$  or greater, water locked up in the concrete rapidly moves away from the source of heat and vaporizes, causing an explosion. In the case of only very small breaches, the salt will ooze through the crack and solidify (no spray of aerosolized particles and gases). In MSR with Rankine steam cycles, slow reactions of salt with the steam must be considered.

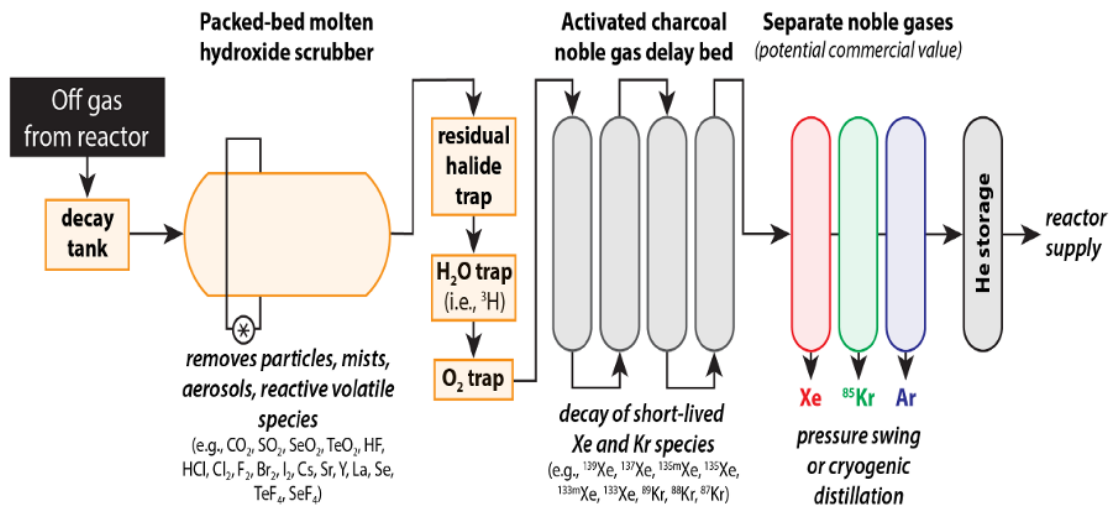


Figure 21. Off-gas system in an MSR [1].

## 7.4 ON-SITE STORAGE OF DISCHARGED WASTE FORMS

The solubility of stored spent fuel salt in water must be considered because the salt or salt components could migrate into the groundwater. The immobilization of salt in a waste form that is chemically resistant to dissolution and transportation from a repository to groundwater or other release to the environment is therefore crucial. Examples of immobilized waste forms are glasses, ceramics, glass ceramics, glass-bonded ceramics, and ceramic-metal composites (cermets)—waste forms that are mineral-based, glass-based, or a metal composite. Figure 22 shows different salt stream separation technologies, along with suggested processing routes and action and/or disposal pathways for both chloride and fluoride salts.

Besides the fuel salt, other relevant sources of waste are as follows:

- Off-gas system: particulates, aerosols, reactive gases,  $^3\text{H}$ , water, residual halides,  $\text{N}_2$ ,  $\text{O}_2$ , noble gases (e.g., Kr, Xe)
- Separated salt streams: following processes such as  $^7\text{Li}$  recovery,  $^{37}\text{Cl}$  recovery, fission product removal
- Metal waste streams: reactor components, plenums
- Salt separation and actinide recovery for reuse in a reactor or for segregated disposal

Many of the other waste forms are dependent on the details of the MSR operation. For example, there are concepts under discussion that assume continuous operation of the reactor for a specific time, after which the entire fuel salt is drained. No fission product removal or actinide recovery is considered in this design, so related waste streams would not be generated. Considerations in this project are therefore focused on storage of the spent fuel salt only.

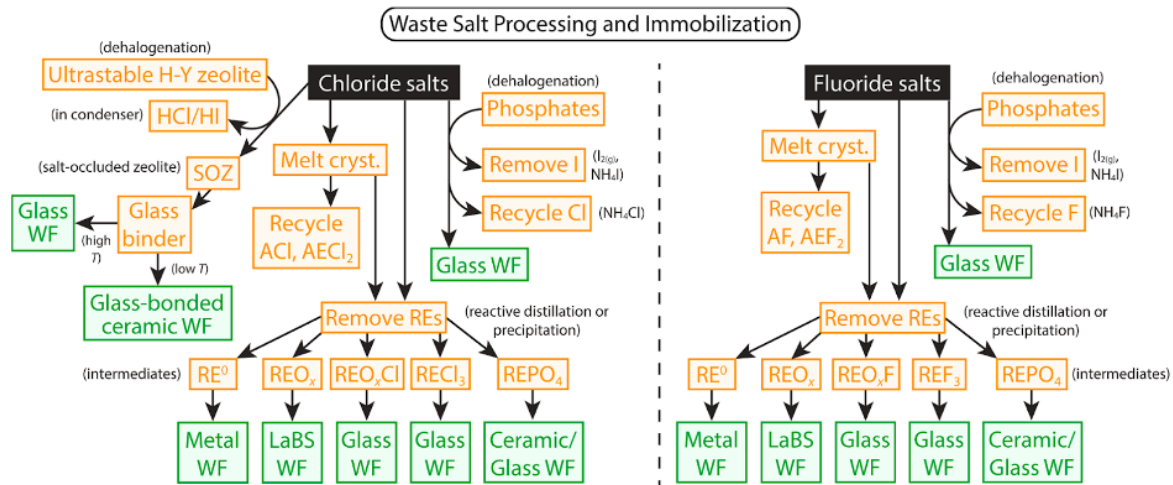


Figure 22. MSR waste salt processing and immobilization [7].

## 7.5 ACCIDENT SCENARIOS

### 7.5.1 FUEL SALT CONDITIONING, MIXING, AND LOADING

Potential scenarios for the U1 stage include criticality accidents related to storage of fissile salt, preparation of fuel salt, and reactions caused by salt spills and suboptimal redox potentials.

#### Criticality

- U1.1: Water surrounding the transportation container → criticality



- U1.2: Water ingress into container → criticality
- U1.3: Damage to container resulting from drop → reduced container array spacing → criticality
- U1.4: Fire → melting of salt → rearrangement of fuel (from multiple cylinders) → criticality
- U1.5: Insufficient mixing of the fissile and carrier salt → batches with high fissile materials → criticality

### Release

- U1.6: Fire → build up of vapors and pressurization in cylinder → combustion or melting of plugs → venting of gases
- U1.7: Moisture and oxygen contamination → corrosion of container because of high corrosivity of fuel salt
- U1.8: Fissile salt, carrier salt, mixture of fissile/carrier salt spill
- U1.9: Incorrect ratios of fissile and carrier salt during mixing → incorrect redox potential → corrosion
- U1.10: Failure in chemistry control → suboptimal redox potential → corrosion
- U1.11: Failure to sufficiently remove impurities/contaminants in molten salt during preparation → corrosion of structural components
- Fluoride salt-specific:
  - U1.12: Water ingress → very slow reaction of  $UF_4$  with water to produce uranyl fluoride ( $UO_2F_2$ , toxic, health and environmental hazard) and HF (RT boiling point, toxic, corrosive)
  - U1.13: Damage of container → Be release caused by salt leak
- Chloride salt specific:
  - U1.14: Release of oxides/hydroxides ( $CCl_4$ ,  $Cl_2$ ,  $COCl_2$ ,  $HCl$ )

## 7.5.2 POWER PRODUCTION WITH ONLINE CHEMICAL PROCESSING

The potential scenarios for the U2 stage address criticality, heat removal, and release scenarios considering the various components during operation. Accidents in the off-gas system related to the salt's high melting point and salt reactions with concrete, water, and air all play important roles.

### Reactivity

- U2.1: Vessel/loop break → core on the floor → criticality outside the reactor core
- U2.2: Inadvertent loading of too much fissile salt into the core → reactivity insertion
- U2.3: Control rod misalignment during primary fuel salt fill → premature criticality
- U2.4: Injection of fuel salt of incorrect concentration → reactivity impact (and potential impact on salt chemistry)
- U2.5: Injection of fuel salt at incorrect temperature → reactivity impact
- U2.6: Unrecognized accumulation of fissile material (depending on the flow rate) → reactivity fluctuations
- U2.7: Changes in gas volume in the fuel loop → occasional release of some gas that collected in the core → reactivity fluctuations

- U2.8: Over cooling leading to precipitation and accumulation → reactivity (concern of possibly precipitating out fissile salt, which would form a higher fissile concentration than the bulk liquid that flows back into the core, thus creating a transient power spike)
- U2.9: Error in assessment of off-gas performance → incorrect assessment of salt composition, especially Xe content
- U2.10: Flow restrictions in helium sparge → insufficient Xe removal
- U2.11: Loss of blanket fuel salt in breeder system → loss of absorption → unexpected reactivity insertion

### **Release**

- U2.12: Flooding → water–salt interactions, including hydrolysis in salt → steam generation
- U2.13: Vessel/loop leak → hot liquid fuel salt – concrete reaction → release of bound water and production of hydrogen
- U2.14: Breach in the off-gas system → release of fission products
- U2.15: Breach in the cover-gas system → release of salt vapors, mists, and aerosols
- U2.16: Water ingress → buildup up HF/HCl/UF<sub>6</sub> → corrosion
- U2.17: Air ingress → buildup up HF/HCl/UF<sub>6</sub> → corrosion
- U2.18: Break/leak/rupture in steam generator, releasing steam into the associate secondary/tertiary heat transfer salt
- U2.19: Tritium release
- U2.20: Drain tank breach
- U2.21: Activation of Argon-41 (110 min half life) in reactor vessel auxiliary cooling system (RVACS)
- U2.22: Failure in chemistry control → suboptimal redox potential → corrosion

### **Heat removal**

- U2.23: Reduced salt pump speed or pump trip → higher build-up of fission products, insufficient heat removal
- U2.24: Failure in the decay heat removal in the off-gas system → plating out of fission products
- U2.25: Failure in the decay heat removal in the off-gas system → increased temperature, higher pressure
- U2.26: Failure in the decay heat removal in the off-gas system: if system cooled with water → break of water tank
- U2.27: Primary fuel salt heat exchanger failure → increase of fuel salt temperature
- U2.28: Failure in heat removal of drain tank
- U2.29: Plating out in heat exchanger → reduced heat removal
- U2.30: Over cooling → solidifying fissile materials at the coldest part of the heat transfer loop (consider that some fuels melt incongruently, and some fuel salts operate near fissile material solubility limits) → loop blockage → reduced heat removal



- U2.31: Core flow blockage resulting from deformation of components (loop, side-arms) → reduced heat removal
- U2.32: Uncontrolled CR insertion → power decrease → overcooling → freezing → reduced heat removal
- U2.33: Core flow channel deformation caused by nonuniform graphite swelling (radiation effect and thermal expansion) → reduced heat removal
- U2.34: Flow restrictions/pressure caused by plate-out, freezing, loose reactor components (e.g., filters, plug systems, etc.) → reduced heat removal

#### **Other**

- U2.35: Inadvertent freeze valve opening

### **7.5.3 ON-SITE STORAGE OF DISCHARGED WASTE FORMS**

The potential scenarios for the U4 stage cover criticality, heat removal, and release scenarios during storage of spent fuel salt and the various waste products.

#### **Criticality**

- U4.1: Water surrounding the storage container/tank → criticality
- U4.2: Water ingress into storage container/tank → criticality
- U4.3: Damage to container resulting from drop → reduced container array spacing → criticality
- U4.4: Radiolysis of moisture-contaminated salt during the long-term storage of salt → precipitation of a uranium species → formation of zones with high fractions of fissile material (U) → criticality (salt slowly freezes/thaws and causes U to migrate, with uneven distribution of U in the salt) [5]

#### **Decay heat**

- U4.5: Failure of active cooling → increase in temperature
- U4.6: Failure of passive cooling → increase in temperature

#### **Release**

- U4.7: Fire → buildup of vapors and pressurization in storage cylinder/tank → combustion or melting of plugs → venting of gases
- U4.8: Water ingress into storage container/tank → buildup up HF/HCl/UF<sub>6</sub> → corrosion
- U4.9: Water ingress into storage container/tank → water-salt interactions, including hydrolysis in salt → steam generation
- U4.10: Air ingress into storage container/tank → buildup up HF/HCl/UF<sub>6</sub> → corrosion
- Fluoride salt:
  - U4.11: Storage of solid fluoride fuel salt at a temperature significantly below its melting point for a significant amount of time (years) → radiation can cause the partial decomposition of the salt, release free fluorine, and result in the formation and partial transport of UF<sub>6</sub> (highly toxic, reacts with water, corrosive to most metals)
  - U4.12: Damage of container/tank → Be release caused by salt leak

## 7.6 REFERENCES

- [1] H. B. Andrews, J. McFarlane, A. S. Chapel, N. D. Bull, D. E. Holcomb, D. D. Wet, M. S. Greenwood, K. G. Myhre, S. A. Bryan, A. Lines, B. J. Riley, H. M. Felmy, and P. W. Humrickhouse. Review of Molten Salt Reactor Off-Gas Management Considerations. *Nuclear Engineering and Design*, 385:111529, 2021. doi:10.1016/j.nucengdes.2021.111529.
- [2] C. Forsberg, P. Peterson, and H. Zhao. *An Advanced Molten Salt Reactor Using High-Temperature Reactor Technology*. <https://technicalreports.ornl.gov/cpppr/y2001/pres/120481.pdf>, 2004. Accessed: 2023-01-04.
- [3] D. E. Holcomb, G. F. Flanagan, B. W. Patton, J. C. Gehin, R. L. Howard, and T. J. Harrison. *Fast Spectrum Molten Salt Reactor Options*. Technical Report ORNL/TM-2011/105, Oak Ridge National Laboratory, Oak Ridge, TN, 2011. URL: <https://info.ornl.gov/sites/publications/files/Pub29596.pdf>.
- [4] D. E. Holcomb, A. J. Huning, A. Guler Yigitoglu, M. D. Muhlheim, W. P. Poore, and G. F. Flanagan. Molten Salt Reactor Initiating Event and Licensing Basis Event Workshop Summary. Technical Report ORNL/TM-2019/1246, Oak Ridge National Laboratory, Oak Ridge, TN, 2019. URL: <https://www.osti.gov/biblio/1561637-molten-salt-reactor-initiating-event-licensing-basis-event-workshop-summary>.
- [5] D. E. Holcomb, A. J. Huning, M. D. Muhlheim, R. S. Denning, and G. F. Flanagan. *Molten Salt Reactor Fundamental Safety Function PIRT*. Technical Report ORNL/TM-2021/2176, Oak Ridge National Laboratory, Oak Ridge, TN, 2021. URL: <https://info.ornl.gov/sites/publications/Files/Pub165504.pdf>.
- [6] J. McFarlane, P. Taylor, D. Holcomb, and W. P. Poore. *Review of Hazards Associated with Molten Salt Reactor Fuel Processing Operations*. Technical Report ORNL/TM-2019/1195, Oak Ridge National Laboratory, Oak Ridge, TN, 2019. URL: <https://info.ornl.gov/sites/publications/Files/Pub126864.pdf>.
- [7] B. J. Riley, J. McFarlane, G. D. DelCul, J. D. Vienna, C. I. Contescu, and C. W. Forsberg. Molten Salt Reactor Waste and Effluent Management Strategies: A Review. *Nuclear Engineering and Design*, 345:94–109, 2019. doi:10.1016/j.nucengdes.2019.02.002.
- [8] R. C. Robertson. *MSRE Design & Operations Report Part 1 Description of Reactor Design*. Technical Report ORNL-TM-728, Oak Ridge National Laboratory, Oak Ridge, TN, 1965. doi:10.2172/4654707.
- [9] J. Serp, M. Allibert, O. Beneš, S. Delpech, O. Feynberg, V. Ghetta, D. Heuer, D. Holcomb, V. Ignatiev, J. L. Kloosterman, L. Luzzi, E. Merle-Lucotte, J. Uhlřf, R. Yoshioka, and D. Zhimin. The Molten Salt Reactor (MSR) in Generation IV: Overview and Perspectives. *Progress in Nuclear Energy*, 77:308–319, 2014. doi:10.1016/j.pnucene.2014.02.014.
- [10] J. H. Shaffer. *Preparation and Handling of Salt Mixtures for the Molten Salt Reactor Experiment*. Technical Report ORNL-4616, Oak Ridge National Laboratory, Oak Ridge, TN, 1971. URL: <https://www.osti.gov/servlets/purl/4074869>.

## 8. FLUORIDE-SALT COOLED HIGH TEMPERATURE REACTOR

The FHR fuel cycle poses unique issues compared to the traditional LWR fuel cycle and other fuel cycles studied for the Volume 5 task. With respect to the fuel, these issues include the fuel components in the form of TRISO particles in fuel pebbles, higher enrichment of the uranium dioxide or uranium oxycarbide, and fuel pebbles at very high burnup. These issues are especially relevant and highlight differences from other fuel cycles with respect to transportation and storage of fresh and spent fuel pebbles. In the fuel utilization stages, the continuous operation of FHRs involving the continuous removal of depleted fuel pebbles and the addition of fresh fuel pebbles introduce new challenges. Furthermore, the molten coolant salt introduces issues as a result of the generation of tritium in the salt and caused by the salt's reactivity with water, air, and concrete in case of salt spills.

The fabrication, transportation, and storage of the coolant salt is not discussed in this work. Considerations of hazards associated with the molten coolant salt are limited to scenarios during fuel utilization.

The “Mark 1” Pebble-Bed Fluoride-Salt-Cooled High-Temperature Reactor (PB-FHR) Power Plant [1] was chosen as the basis for the development of the FHR fuel cycle. Resources FHR were studied to determine comprehensive lists of potential accident scenarios for the different utilization stages [2–4, 6]. The fuel enrichment, TRISO particle fabrication, fuel pebble fabrication, and transportation of enriched UF<sub>6</sub> and fuel pebbles are considered in previous chapters (see Chapters 2, 4, and 5).

### 8.1 PLANT AND OPERATION DESCRIPTION

The “Mark 1” PB-FHR, which was used as the reference for the FHR fuel cycle, is the preconceptual design for a small modular 236 MWth reactor developed by the University of California, Berkeley (UCB) (Figure 23). The Mark-1 (Mk1) PB-FHR design was developed within the scope of a US Department of Energy project to establish the technical basis to design, license, and commercially deploy FHRs [1].

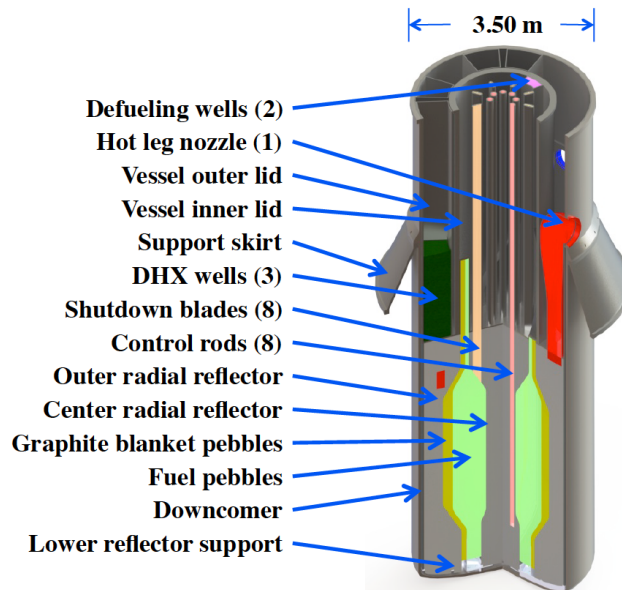


Figure 23. The UCB PB-FHR reactor vessel [1].

The PB-FHR Mark-1 design combines the HTGR fuel form with liquid fluoride salt coolant in a graphite-moderated environment. The annular core, together with the fueling and defueling chutes, is filled with

470,000 fuel pebbles surrounded by 218,000 graphite moderator pebbles, and the core is contained in graphite reflector structures. The pebbles travel from the bottom of the core to the top. On average, a fuel pebble completes 8 passes through the core before reaching its final discharge burnup of 180 GWd/tHM. As in an HTGR, the fuel pebbles contain TRISO particles distributed in a graphite matrix. The FHR pebbles contains an average of 4,730 TRISO particles, which corresponds to ~1.5 gU per pebble. However, the fuel pebbles in the FHR are significantly smaller (3 cm diameter compared with the 6 cm diameter in a typical HTGR). The fuel particles within the FHR pebble are distributed in a shell-like fuel region instead of a spherical fuel region in a typical HTGR.

The fuel material is UCO with an enrichment of 19.9 wt%  $^{235}\text{U}$ . The coolant salt Flibe, a mixture of LiF and  $\text{BeF}_2$ , is circulated at a rate of 976 kg/s. Core inlet and outlet temperatures are approximately 600 and 700°C, respectively, and the fuel temperature ranges between 700 and 800°C. Reactivity control is achieved using control rods and blades containing boron carbide. Heat removal is performed through coiled tube air heaters (CTAHs) in a Nuclear Air - Brayton Cycle (NAAC) (Figure 24).

For most of its lifetime, the plant is operated at a state of equilibrium during which fuel pebbles are continuously added and removed from the core so that the average fuel inventory in each core region remains approximately the same. At each point in time during operation at equilibrium, a mixture of fuel pebbles at different passes (passes 1 through 8) are contained in the core. A fuel pebble has an average residence time of 60 days in the core, followed by 4 days of cooling in the defueling chute. Depending on the accumulated burnup, a fuel pebble is either reinserted into the core for another pass, or it is or discharged. A pebble accumulates approximately 1.4 years of residence time at full power operation before reaching the final burnup of 180 GWd/tHM. Approximately 10,800 pebbles are removed from the core per day, and approximately 920 pebbles are consumed/discharged per day and are not re-inserted. Over the course of the plant's 60-year lifetime, approximately 20 million fuel pebbles are consumed.

For the purpose of this fuel cycle and the efforts in this project, it is assumed that the graphite pebbles are continuously circulated and not replaced, although in actual reactor operation, the graphite pebbles would be replaced if they reached a certain tritium absorption rate or were damaged.

### **8.1.1 PEBBLE HANDLING AND STORAGE SYSTEM**

The key system in the FHR is the pebble handling and storage system (PHSS). This system manages pebble insertion and removal, including initial pebble loading and approach to criticality; it monitors and tracks pebble inventories; it manages damaged pebbles and pebble fragments so that they do not inhibit the reactor operation; and it manages pebble surface contamination with gas/moisture/salt while minimizing pebble wear and graphite dust generation. Redundant components are included to avoid the need for unplanned outages during continuous operation.

Figure 25 provides a simplified flow diagram of the PHSS during normal operation. The pebbles enter the core through injection channels: four injection channels for the active fuel pebble region, and four injection channels for the inert graphite pebble outer reflector region (Figure 26). The pebbles are removed from the top of the defueling chute through two CUDs. They enter the pebble fragment sorting system, where damaged pebbles are sorted out, before they reach the BUMS, where it is determined whether the pebbles are to be reinserted into the core or if they are discharged. The circulation rate of pebbles in the PHSS is 450 pebbles/hour during normal operation. During core unloading, a maximum rate of 3,600 pebbles/hour is achieved, resulting in complete core defueling in 8 days. The pebbles are transported in the different pipes of the PHSS via buoyancy and fluid drag forces in the primary coolant. The conditions match that of the core inlet at 600°C and near atmospheric pressure.

The PHSS includes the pebble canister transfer system (PCTS) to manage pebble transfer into and out of the primary coolant. It uses two active fuel pebble storage canisters and two canisters for graphite pebbles.

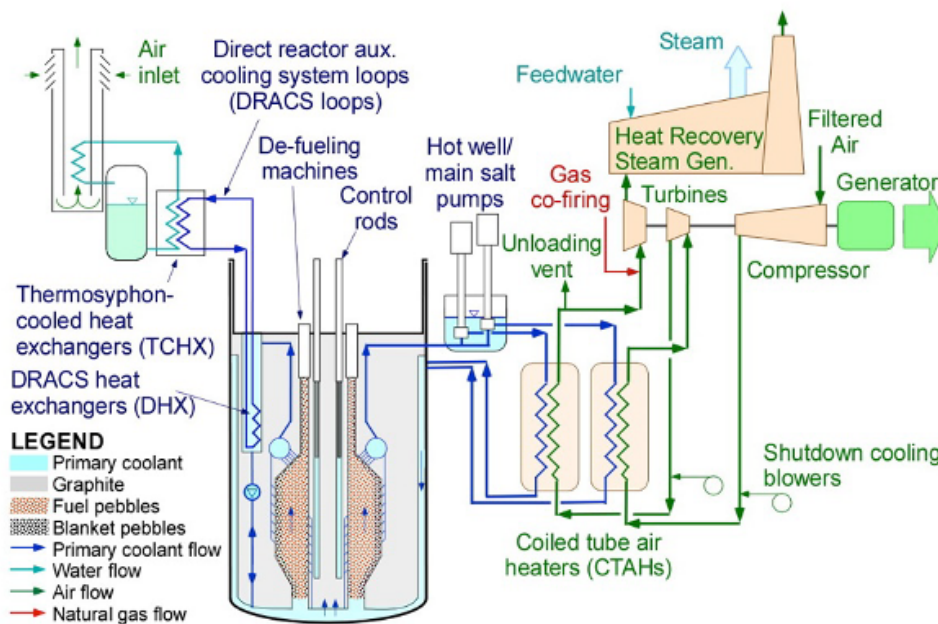


Figure 24. UCB PB-FHR flow schematic [1].

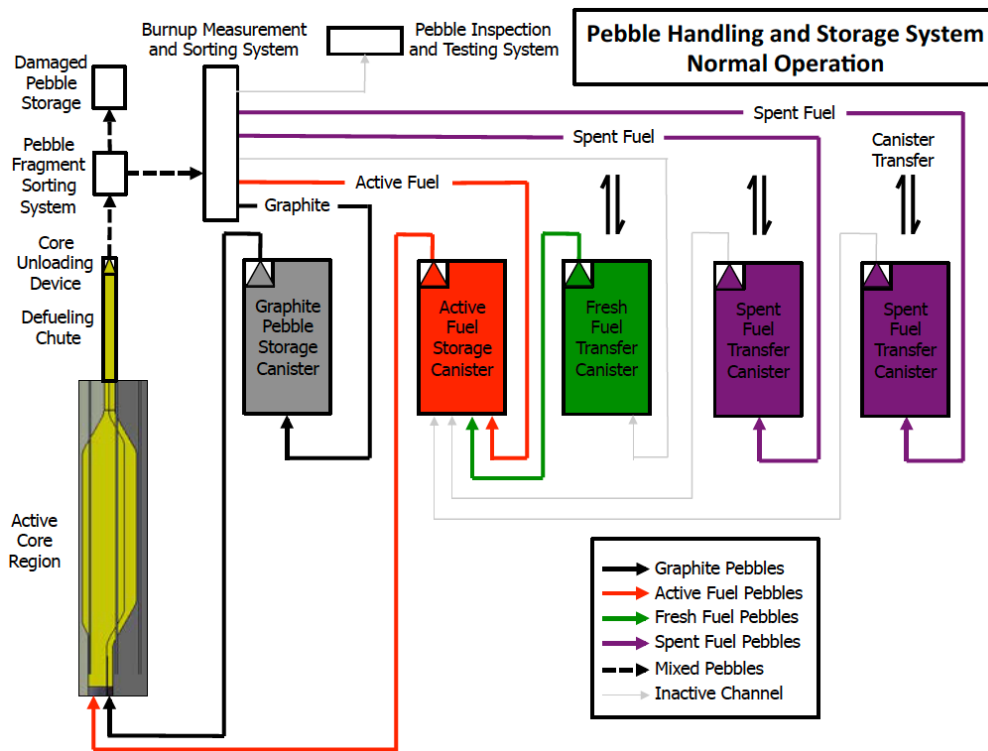


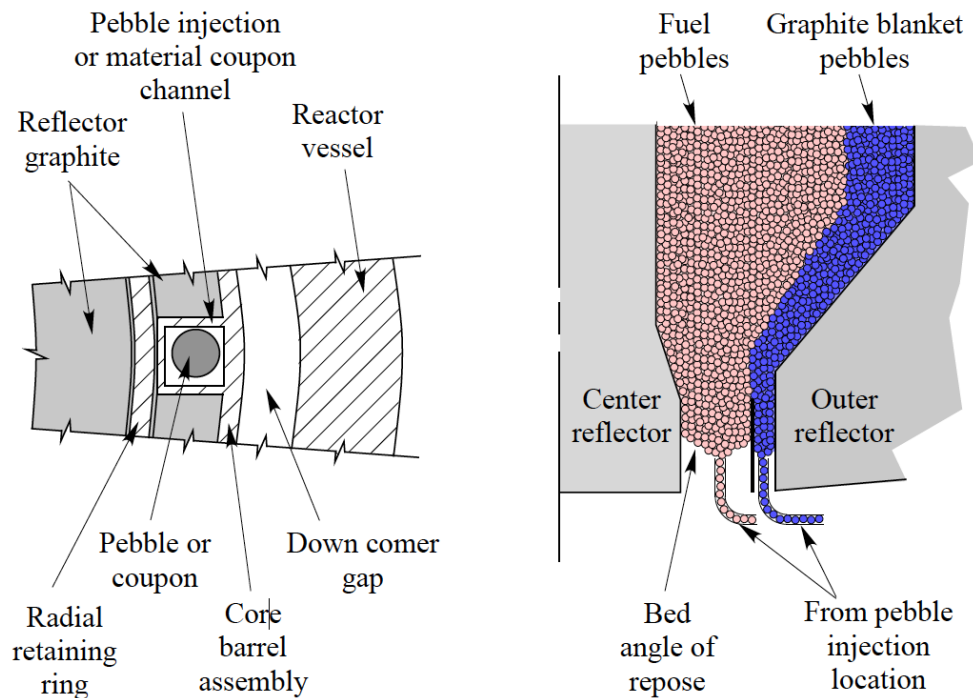
Figure 25. Simplified process flow diagram for the PHSS under normal operation [1].

Fresh fuel pebbles are stored in two transfer canisters. Before they enter the PHSS, they are preconditioned to remove moisture and oxygen residuals. Four transfer canisters are dedicated to collecting the spent fuel pebbles that have been cleaned of salt residuals before they are transported from the pebble handling chamber via a gas-lock system with an inert gas atmosphere to the spent fuel storage area. The canisters described for the UCB PB-FHR can contain up to 29,440 pebbles, which equals the amount of fuel pebbles discharged within 32 effective full-power day (EFPD). Each transfer canister has a heat load of 25 kW under normal operation and up to 41 kW during defueling for maintenance or for other reasons.

Besides the two CUDs that extract the pebbles from the core, there is a pebble canister unloading device (PCUD) for each canister. The major function of these devices is to transfer pebbles from large diameter volume pebble-beds to small diameter piping that is used to hydraulically transfer pebbles. The major challenge is the jamming of pebbles, which is prevented through pneumatic or hydraulic jets that agitate pebbles near the small diameter orifice.

In the BUMS, the fuel pebble burnup is measured using a high-purity germanium detector to perform gamma spectroscopy to measure  $^{137}\text{Cs}$  inventory. The challenge in the gamma spectroscopy is the presence of gamma peaks neighboring the prominent 661.6 keV  $^{137}\text{Cs}$  peak and the Compton scattering background. This can be mitigated by allowing short-lived isotopes to decay sufficiently before being measured. Short-lived isotopes are more abundant in an FHR compared to HTGRs and other systems because of the high power density. The accuracy of the BUMS depends on how long short-lived isotopes were able to decay to reduce background noise and how long the actual measurement is performed.

Although the UCB PB-FHR assumed storage of spent fuel pebbles in containers in a dry storage, this FHR fuel cycle assumes that the spent fuel containers are stored for an amount of time in a spent fuel pool as planned for another prototype FHR [5] before they are moved to dry storage.

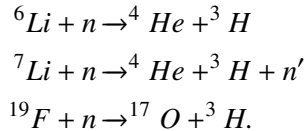


**Figure 26. Pebble injection channels schematic [1].**

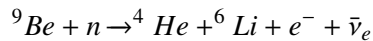


### 8.1.2 TRITIUM MANAGEMENT

Using Flibe as a coolant leads FHRs to produce considerable quantities of tritium. As a low-energy beta emitter, tritium presents a health hazard when ingested or absorbed through the skin (e.g., via tritiated water HTO), so the generation and release paths of tritium need to be understood and avoided. The tritium production rate in an FHR is hundreds of times higher than the same rate in an LWR [7]. The bulk of tritium production in an FHR is from neutron interactions with lithium and fluorine in the coolant through the following reactions:



Given the large tritium generation cross section (n,t) of  ${}^6\text{Li}$ , the lithium used in the UCB PB-FHR's Flibe is enriched to 99.995%  ${}^7\text{Li}$ . Other reactor concepts use Flibe target even higher Li enrichment levels. Even when using enriched Li, the tritium production through  ${}^6\text{Li}$  provides the most significant production channel for tritium when using fresh coolant salt, for example at the beginning of reactor operation. The tritium production through this channel is continuously depleting the small amount of  ${}^6\text{Li}$  in Flibe until the tritium production rate reaches an equilibrium. An equilibrium tritium production rate is established because of the continuous tritium production from  ${}^7\text{Li}$  and  ${}^{19}\text{F}$  listed above and because neutron interactions with beryllium in the coolant produce  ${}^6\text{Li}$ , which is partially or completely replenishing the initial  ${}^6\text{Li}$  inventory [7]:



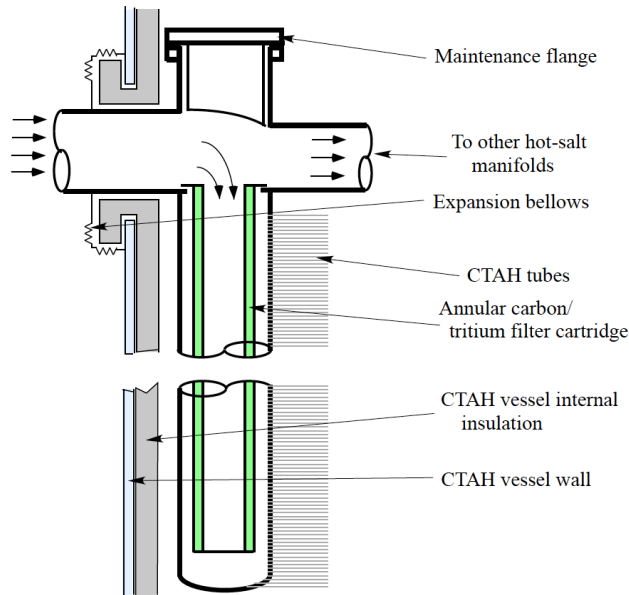
At equilibrium, the UCB PB-FHR produces 0.023 mol/EFPD tritium corresponding to 670 Ci/EFPD. The generated tritium can be carried along in the coolant and is transported to different surfaces in the reactor (moderator and reflector graphite, fuel pebbles, pipes, heat exchangers, etc.). Different reactions of tritium (corrosion, adsorption, permeation, etc.) may occur at these surfaces, requiring the management of tritium by providing sufficient tritium absorption and preventing tritium released via permeation through surfaces such as the thin surfaces of the heat exchanger.

The UCB PB-FHR design mainly relies on tritium absorption in graphite and permeation barriers in the heat exchanger. The UCB PB-FHR design includes a tritium filtering system in the form of cartridges containing carbon balls measuring 2 mm in diameter located in the hot salt manifold of the heat exchanger (Figure 27). Salt flows through these cartridges, depositing tritium in graphite before reaching the heat exchanger. This filtering system doubles the graphite surface area in the system and approximately halves the tritium content of the salt in the primary loop. Additionally, fuel and reflector pebbles, as well as structural graphite, provide a large carbon surface area to absorb tritium. To prevent the remaining tritium from permeating through the CTAH tubes, the air sides of the tubes are coated with  $\text{Al}_2\text{O}_3$  [1].

### 8.1.3 BERYLLIUM CONTROL AND SALT ACTIVATION

Along with tritium generation, the presence of beryllium in the coolant and coolant activation during reactor operation must be considered.

The primary hazard of beryllium is the risk of inhaling aerosol particles containing beryllium and the consequent accumulation of toxic beryllium in the body. Aerosols can be produced through Flibe salt spills.



**Figure 27. Schematic figure of hot-salt manifold pipe showing inspection and maintenance flange and annular tritium and particulate filter cartridge [1].**

The UCB PB-FHR's mitigation strategy is based on a thorough monitoring and decontamination procedure similar the process used for radiation protection and control. The ventilation system is zoned with air flow from zones with low beryllium (or radioactive) contamination to zones with potentially higher contamination. To prevent beryllium release through leaks in the CTAHs, the air pressure exceeds the salt pressure, so that air would ingress into the salt loop, but not vice versa.

The hazards of the salt activation mainly concern the gamma dose through the decay of activation products  $^{19}\text{O}$  ( $t_{1/2}=26.9\text{s}$ , 1.4 MeV gamma),  $^{16}\text{N}$  ( $t_{1/2}=7.1\text{s}$ , 6.1 MeV gamma), and  $^{20}\text{F}$  ( $t_{1/2}=20\text{s}$ , 1.633 MeV and 3.333 MeV gammas). The gamma dose during power operation is dominated by  $^{20}\text{F}$  decay, whereas the gamma dose after shutdown is dominated by decay of Flibe impurities, corrosion products, and fission products released from defective particles. The activation of salt components requires shielding of external piping and needs to be considered in case of salt spills.

## 8.2 ACCIDENT SCENARIOS

### 8.2.1 FRESH FUEL PEBBLE STAGING AND LOADING

The potential scenarios for the U1 stage are limited to criticality accidents related to the storage and handling of fresh fuel pebbles in the pebble handling chamber.

#### Criticality

- U1.1: Water surrounding the array of canisters at an optimal moderator-to-fuel ratio and optimal canister → criticality
- U1.2: Water ingress into the array of canisters at an optimal moderator-to-fuel ratio → criticality
- U1.3: Water surrounding the array of canisters with simultaneous water ingress at optimal moderator-to-fuel ratio → criticality
- U1.4: Misplacement of array of graphite pebble and fuel pebble containers → additional moderation caused by graphite moderator → criticality



- U1.5: Damage to container resulting from dropping → reduced container array spacing → criticality
- U1.6: Fire in pebble handling chamber → fire of fuel pebble graphite
- U1.7: Fire in pebble handling chamber → extinguishing water contacts graphite at high temperature → graphite corrosion and development of graphite dust

## 8.2.2 POWER PRODUCTION

The potential scenarios for the U2 stage include criticality, heat removal, and release scenarios during fuel pebble loading into the PHSS, pebble in the pipes, insertion into and removal of pebbles from the core, fuel pebble burnup measurement, and other scenarios during operation.

### Criticality

- U2.1: Failure in PHSS system → additional pebbles enter core → criticality
- U2.2: Failure in BUMS → pebbles with low burnup replaced by fresh pebbles → too many fresh fuel pebbles enter the core → criticality
- U2.3: Pebble jamming in CUD → pebbles not removed from reactor, but more pebbles are added → criticality
- U2.4: Seismic events → reorientation of pebbles → criticality
- U2.5: Water steam ingress into core without control rod insertion → criticality

### Heat removal

- U2.6: Blockage of coolant flow paths at the bottom of the core or central reflector caused by large quantities of debris from pebble fragments → temperature increase
- U2.7: Salt freezing within PHSS in the pebble handling chamber → flow blockage → temperature increase
- U2.8: Failure of the PCTS while a pebble is being transferred out of the primary coolant → insufficient cooling of fuel pebbles → temperature increase
- U2.9: Loss of forced cooling in the pebble handling chamber → temperature increase
- U2.10: Accumulation of hot pebbles in PHSS pipes at high temperatures (“pebble jam”) caused by an error in PHSS or stuck pebbles caused by a damaged or swollen pebble → temperature increase

### Release

- U2.11: Failure of the PCTS while a pebble canister is being transferred out of the primary system → air ingress into the pebble transfer canister → graphite oxidation → pebble damage
- U2.12: Thermal shock of the CTAH tubes causes the  $\text{Al}_2\text{O}_3$  layer to fail → increased tritium permeation through the tube → tritium release
- U2.13: Salt spill or salt contamination of canisters → Be release
- U2.14: Graphite dust catches fire from sparks or heat
- U2.15: Broken pebble gets stuck in reactor → fission product release into salt coolant
- U2.16: Salt spill at high temperatures → hot liquid fuel salt – concrete reaction → release of bound water and production of hydrogen

- U2.17: Salt spill at high temperatures during flooding in pebble handling chamber → water–salt interactions, including hydrolysis in salt → steam generation
- U2.18: Salt spill at high temperatures during flooding in pebble handling chamber → build up of HF → corrosion
- U2.19: Salt spill → release of fission products from the salt (noble metals, gases, etc.) and activated corrosion products
- U2.20: Break in the cover-gas system → release of fission products that were released from salt as a result of defective pebbles
- U2.20: Insufficient oxygen/water (contamination) removal of fuel pebbles before they meet the hot primary coolant → reaction of oxygen with carbon → pebble damage
- U2.21: Vibrations and rapid pebble handling in pipes without salt → mechanical damage to pebbles → fission product release into salt

### 8.2.3 ON-SITE DRY CASK STORAGE

The potential scenarios for the U4 stage include criticality, heat removal, and release scenarios during the loading of pebbles into spent fuel containers and the handling and storage of spent fuel containers. Unless specified differently, the listed accident scenarios apply to the spent fuel pool storage and dry storage.

#### Criticality

- U4.1: Graphite pebbles are misloaded into spent fuel pebble container → criticality event
- U4.2: BUMS malfunction → pebbles with lower burnup than discharge burnup are misloaded into fuel pebble storage → criticality event (spent fuel pool and dry storage)
- U4.3: Water ingress and water surrounding spent fuel container → criticality event in dry storage
- U4.4: Spent fuel container damage → reorientation of fuel pebbles → criticality event

#### Heat removal

- U4.5: BUMS malfunction → pebbles with higher burnup than that of discharge burnup are misloaded into fuel pebble storage → increased temperature from decay heat
- U4.6: Failure of the active or passive cooling system → temperature increase

#### Release

- U4.7: Residuals of coolant salt on spent fuel pebbles → radiolysis of solid fluoride salt at low temperatures → generation of fluorine gas  $F_2$  and potentially HF (both toxic, corrosive) and metallic atoms (Li and Be) → release into coolant water or circulating air (assuming defective container seal)
- U4.8: Residuals of coolant salt on spent fuel pebbles → release of activation products of salt components and release of fission products from defective pebbles resolved in the salt into coolant water or circulating air (assuming defective container seal)
- U4.9: Manufacturing defects of fuel pebbles and migration of fission products in graphite matrix → release of fission products from defective pebbles from a defective container into coolant water or circulating air
- U4.10: Accident during transportation of spent fuel containers to storage area → damage to container and pebbles → fission product release to surrounding air

- U4.11: Gamma radiation from fuel pebbles causes radiolysis of the air → extremely corrosive elements such as nitric acid and ozone are released in the air → graphite corrosion → fuel pebble failure
- U4.12: Sparks from machinery, equipment, electrical circuits, or human activities → fire
- U4.13: Radiolysis of the coolant air → evolution of explosive gas mixtures → explosion

### 8.3 REFERENCES

- [1] C. Andreades, A. T. Cisneros, J. K. Choi, A. Y. K. Chong, M. Fratoni, S. Hong, L. R. Huddar, K. D. Huff, D. L. Krumwiede, M. R. Laufer, M. Munk, R. O. Scarlat, N. Zweibaum, E. Greenspan, and P. F. Peterson. *Technical Description of the “Mark 1” Pebble-Bed Fluoride-Salt-Cooled High-Temperature Reactor (PB-FHR) Power Plant*. Technical Report UCBTH-14-002, University of California, Berkeley, CA, 2014. URL: <https://web.mit.edu/nse/pdf/researchstaff/forsberg/FHRPointDesign14-002UCB.pdf>.
- [2] C. Forsberg and P. F. Peterson. Spent Nuclear Fuel and Graphite Management for Salt-Cooled Reactors: Storage, Safeguards, and Repository Disposal. *Nuclear Technology*, 191(2):113–121, 2015. doi:10.13182/NT14-88.
- [3] D. E. Holcomb, G. F. Flanagan, G. T. Mays, W. D. Pointer, K. R. Robb, and G. L. Yoder Jr. *Fluoride Salt-Cooled High-Temperature Reactor Technology Development and Demonstration Roadmap*. Technical Report ORNL/TM-2013/401, Oak Ridge National Laboratory, Oak Ridge, TN, 2013. URL: <http://www.osti.gov/servlets/purl/1107839/>.
- [4] Kairos Power LLC. *KP-FHR Mechanistic Source Term Methodology*. Technical Report KP-TR-012-NP, Kairos Power LLC, Alameda, CA, 2020. URL: <https://www.nrc.gov/docs/ML2018/ML20182A785.pdf>.
- [5] Kairos Power LLC. *Hermes Non-Power Reactor Preliminary Safety Analysis Report*. Technical Report HER-PSAR-001, Kairos Power LLC, Alameda, CA, 2021. URL: <https://www.nrc.gov/docs/ML2127/ML21272A378.pdf>.
- [6] R. O. Scarlat, M. R. Laufer, E. D. Blandford, N. Zweibaum, D. L. Krumwiede, A. T. Cisneros, C. Andreades, C. W. Forsberg, E. Greenspan, L. W. Hu, and P. F. Peterson. Design and Licensing Strategies for the Fluoride-Salt-Cooled, High-Temperature Reactor (FHR) Technology. *Progress in Nuclear Energy*, 77:406–420, 2014. doi:10.1016/j.pnucene.2014.07.002.
- [7] J. D. Stempien, R. G. Ballinger, and C. W. Forsberg. An Integrated Model of Tritium Transport and Corrosion in Fluoride Salt-Cooled High-Temperature Reactors (FHRs) – Part I: Theory and Benchmarking. *Nuclear Engineering and Design*, 310:258–272, 2016. doi:10.1016/j.nucengdes.2016.10.051.

## 9. SODIUM-COOLED FAST REACTOR

The SFR fuel cycle poses unique issues compared to the traditional LWR fuel cycle and other fuel cycles studied for the Volume 5 task. These issues include consideration of higher enrichment impact on criticality during storage and transportation. New chemicals and processes used for fuel fabrication must be analyzed and considered during accident scenario identification [1–6]. Sodium is reactive with water, air, and concrete, so inert rooms and cells are common throughout the reactor system. Sodium is also opaque, leading to a high reliance on instrumentation & control (I&C) for maintenance and operations because visual inspection is challenging [3,6]. This high reliance on I&C and remote fuel handling systems introduces new challenges and accident scenarios. Another issue of concern is that the sodium bond in SFR fuel can corrode. Although fuel without sodium bond is currently being considered for SFRs, this work considers sodium-bonded SFR fuel.

There is also the potential implementation of a closed-fuel cycle with SFRs by reprocessing the spent fuel for subsequent fuel fabrication and use in the SFR. While it is possible to maintain a once-through fuel cycle for SFRs with HALEU, it is also possible to consider a fuel cycle with HALEU and recycled spent LWR fuel in an SFR. The calculations resulting in an ABTR equilibrium core as described in [2] initially started with weapons-grade Pu (Pu containing more than 93 wt%  $^{239}\text{Pu}$ ) in the driver assemblies and recycled LWR spent fuel in the fuel test assembly locations. The weapons-grade Pu and the recycled LWR spent fuel can be substituted with HALEU. In addition, reprocessing of spent SFR fuel can also be considered to include recycling of U and Pu or TRU in the SFR fuel assemblies to close the fuel cycle. The hazards that arise during the operation and storage of fuel during the utilization stages are assumed to stay the same, regardless of which fuel type used. However, these hazards are expected to differ based on whether the fuel is reprocessed during the fuel fabrication and transport stages, as mentioned above, as a result of the additional security measures, shielding, and chemical processing of fuel required during reprocessing.

For this work, the ABTR was chosen as basis for the development of the SFR fuel cycle as described in more detail in Section 9.1. The major resources used to identify accident scenarios for the SFR fuel cycle were the ABTR design report [2], the Preapplication Safety Evaluation Report for a SFR [5], and US DOE’s “Technology and Safety Overview” of SFRs [3].

The following sections discuss the various stages of an SFR, which are all handled by remote fuel handling machines. The fuel enrichment, spent fuel re-processing, fuel assembly fabrication, and transportation of enriched  $\text{UF}_6$  and fuel assemblies are considered in previous chapters (see Chapters 2, 3, 4, and 5).

### 9.1 PLANT AND OPERATION DESCRIPTION

The ABTR is a 250 MWt core design with ternary metal alloy fuel (U-TRU-Zr) with 199 assemblies in total (Figure 29) [2]. The primary reactor system is a pool-type system with a reactor core, primary pumps, intermediate heat exchangers (IHX), and direct reactor auxiliary cooling system (DRACS) heat exchangers, all contained within a pool of sodium coolant in a reactor vessel (Figure 28). The primary coolant piping is located within the sodium pool which reduces the possibility of a loss of coolant accident. The reactor vessel has no penetrations, thereby reducing the likelihood of leaking sodium. The hot sodium at the core outlet is separated from the cold sodium at the core inlet by a structure called a redan so that the reactor vessel is exposed to only the cold sodium outside the redan. Two primary pumps pull sodium from the lower regions of the cold pool and discharge the cool sodium evenly into the inlet plenum, which distributes the primary sodium to the inlet of the core assemblies. As the sodium flows through the core, it heats up and exits through the outlet plenum and into the redan, and then it enters the inlet of the IHX. After the primary sodium transfers its heat to the intermediate sodium in the IHX, the primary sodium exits the IHX into the

lower regions of the cold pool. The intermediate sodium exits the IHX and flows into a Na-to-CO<sub>2</sub> heat exchanger located below the nuclear island. This heat exchanger is a Brayton cycle power conversion system. Here the intermediate sodium heats up the supercritical CO<sub>2</sub>, which flows into a turbine-generator that will produce electricity. The DRACS is used in the ABTR to provide forced flow and natural convection cooling. It removes decay heat from the pool and also provides forced flow if required, and in cases of emergency, it can remove decay heat through natural convection.

There are 54 driver assemblies divided into 2 enrichment zones. The inner core is composed of 24 assemblies with 16.5 wt% enrichment (TRU fraction), and the outer core is composed of 30 driver assemblies with 20.7 wt% enrichment (TRU fraction). There are 78 reflector assemblies, 48 shield assemblies, 10 control rod assemblies, and 9 test assemblies. In the development of the ABTR equilibrium fuel compositions, Chang et al. [2] state that REBUS-3 equilibrium cycle calculations assumed that there was no recycling of spent fuel. However, it is possible to reprocess the spent fuel from a fast reactor and refabricate fuel for reinsertion into an SFR. However, this would be a closed fuel cycle. It is assumed for the ABTR that weapons-grade Pu was used for calculations for TRU in driver assemblies, whereas recycled spent fuel from LWRs, denoted by LWR-SF TRU in Chang et al. [2], was used in fuel test assemblies.

ABTR refueling can take about 10 hours per assembly, and the fuel cycle length is four months. The inner core, outer core, and test assembly batches are 12, 15 and 12 respectively. Therefore, the outer core and test assemblies have a fuel residence time of 60 months, whereas the inner core assemblies have a fuel residence time of 48 months. During every refueling, a maximum of seven components can be replaced. The following assemblies/components are expected to be replaced:

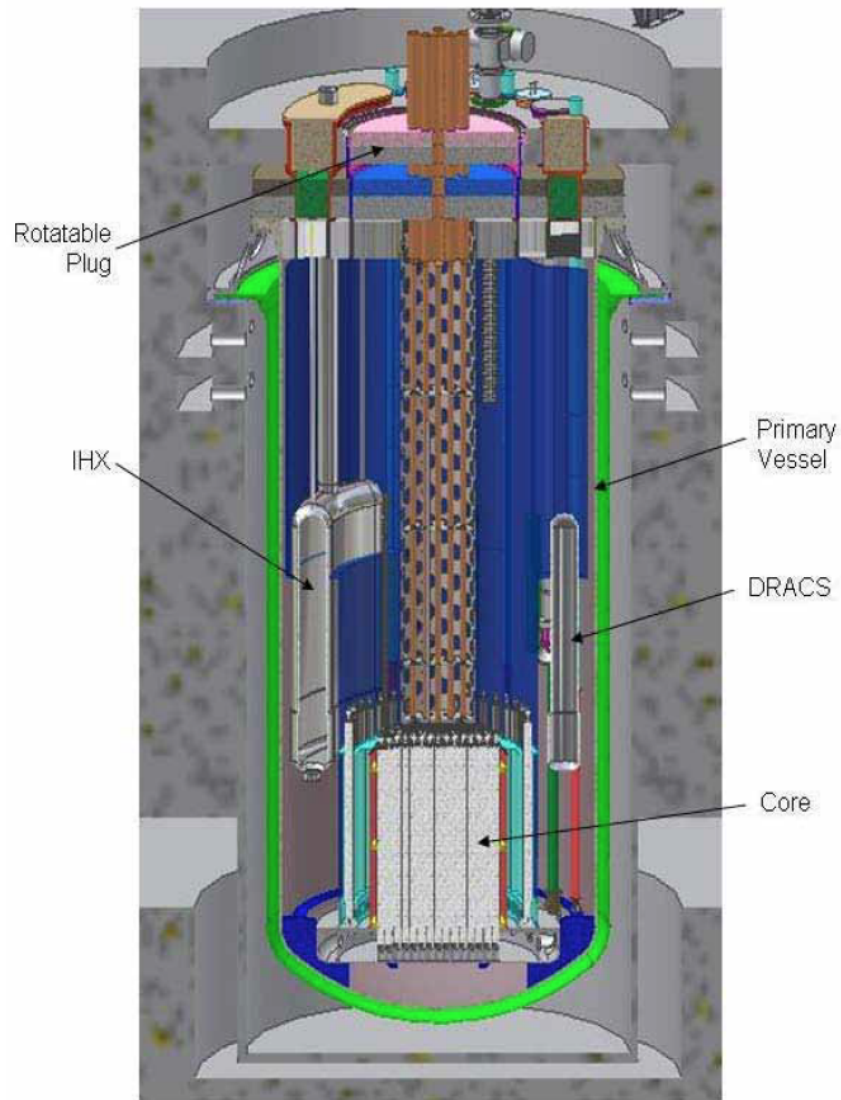
- 2 inner core assemblies
- 2 outer core assemblies
- 0 or 1 test fuel assembly
- 0 or 1 test material assembly
- 0 or 1 control rods

The fuel handling system for an ABTR (Figure 30) is responsible for removing core assemblies (fuel, reflector, shield) out of the reactor at the end of life. This system is also responsible for transferring assemblies out of the reactor and reloading the core with fresh assemblies. It rearranges core assemblies and also performs minor loading adjustments and refinements. The fuel handling system moves fuel assemblies from the storage rack positions to unloading positions.

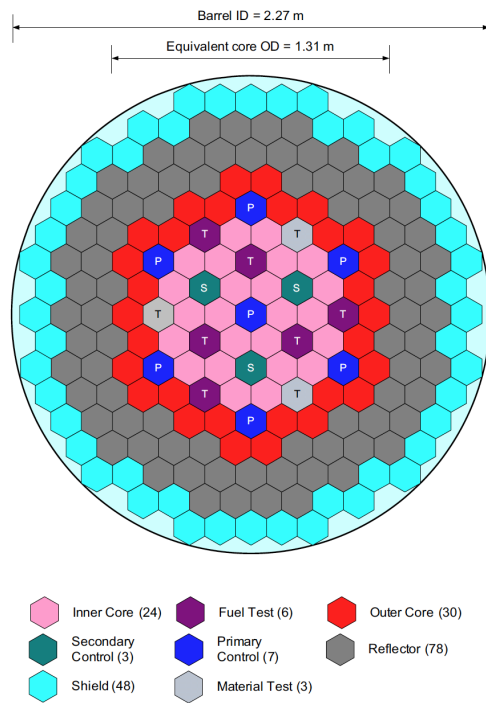
The entire fuel handling system is composed of multiple components; the major components are as follows [2,5]:

- Rotatable plug
- pantograph fuel handling machine (PFHM)
- Storage rack
- fuel unloading machine (FUM)
- inter-building cask (IBC)
- Intra-building transfer tunnel

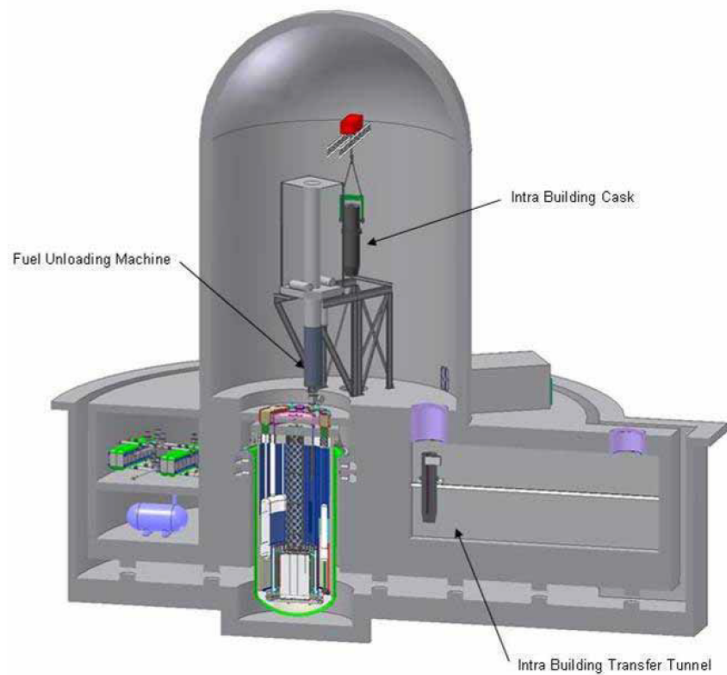
These major components are described in more detail in Section 9.2.



**Figure 28. ABTR primary system [2].**



**Figure 29. ABTR core layout [2].**

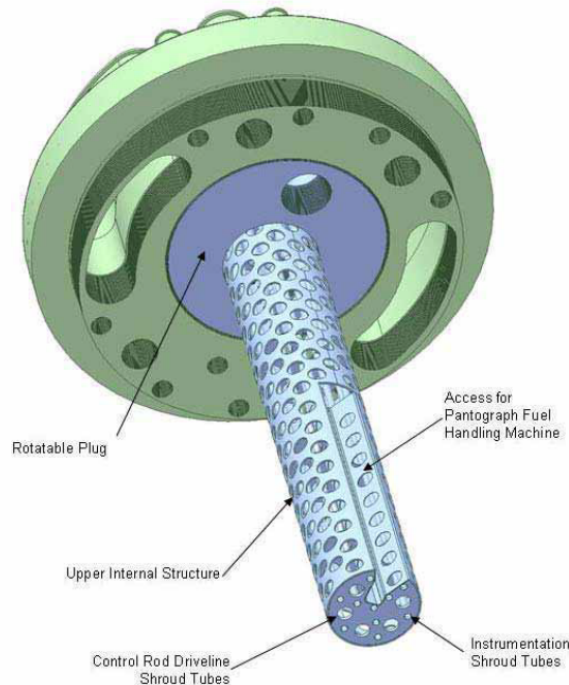


**Figure 30. Fuel handling system in an ABTR [2].**



## 9.2 FUEL HANDLING SYSTEM

The rotatable plug (Figure 31) above the core supports the control rod drives and provides the PFHM access to all the core subassembly positions. It is slotted to give PFHM access to all core positions. The rotatable plug is mounted on a motor-driven bearing and has an elastomer seal to provide a gas-tight seal with the cover, and it is only rotated during fuel handling operations when the reactor is shutdown. The control rod drive lines are disconnected from the rods, and only then is the plug rotated and the PFHM operated for fuel handling operations.



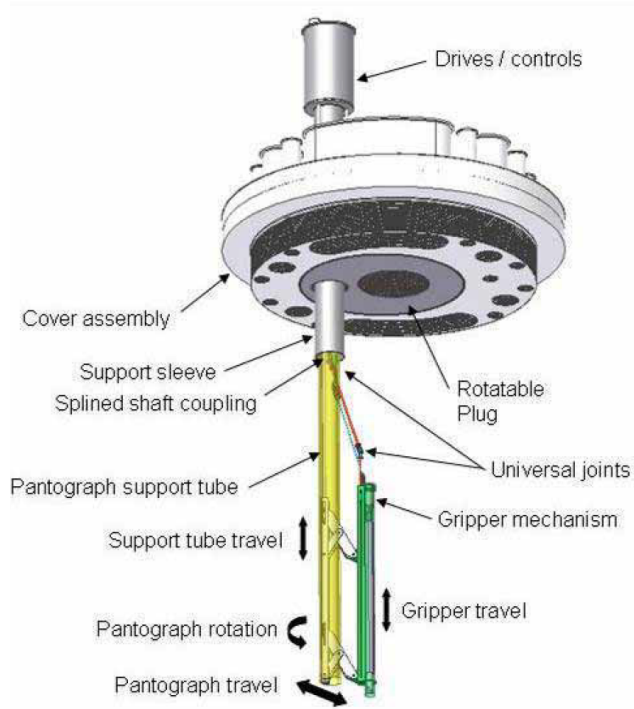
**Figure 31. Rotatable plug in the ABTR [2].**

The PFHM transfers fresh assemblies into the core and removes spent core assemblies from the core barrel (Figure 32). It places assemblies in a storage rack within the core and retrieves core assemblies from the transfer position inside the redan within the storage rack. It is located and supported on the rotatable plug. The PFHM can be positioned over any core assembly in the core by rotating the PFHM, extending or retracting the pantograph arm, and/or rotating the rotatable plug.

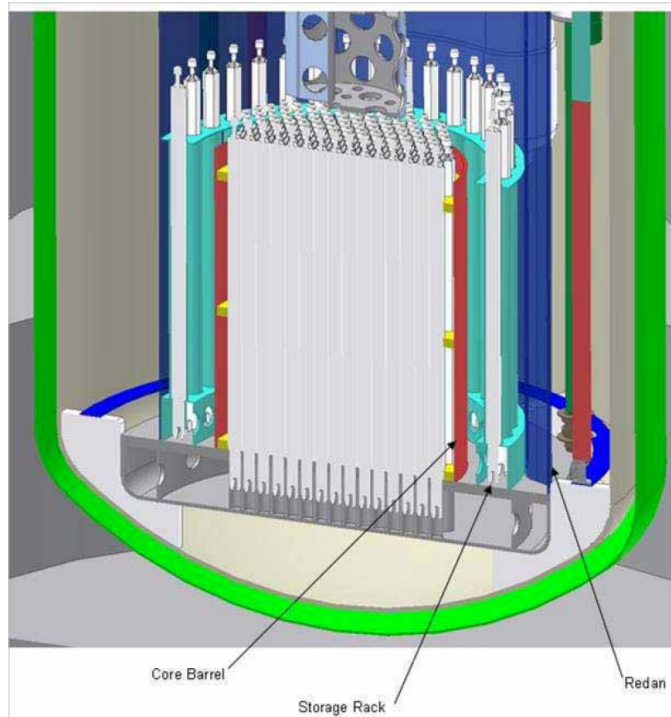
The fuel storage rack (Figure 33) located within the core is also an integral part of the fuel handling system. The storage rack is located outside the core barrel but inside the redan wall. The redan wall separates the hot salt within the core from the cool salt on the other side of the wall. Fresh fuel assemblies are to be preloaded into the reactor vessel on the fuel storage rack. The storage rack is also meant to store spent core assemblies that are removed from the core where they are allowed to decay before being removed from the reactor. The rack's open construction and its proximity to the cold sodium pool near the redan induces natural convection of sodium to cool the spent fuel. There are 36 positions on the storage rack. One position located below the FUM, which is located on the cover of the reactor, is used to cue the FUM that core assemblies on the storage rack below are ready for removal from the reactor by the FUM.

The FUM/transfer port (Figure 34) uses a shielded cask mounted on a self-propelled frame. The frame moves on rails between the transfer port and the IBC pit area. The FUM has a gripper for inserting and retrieving



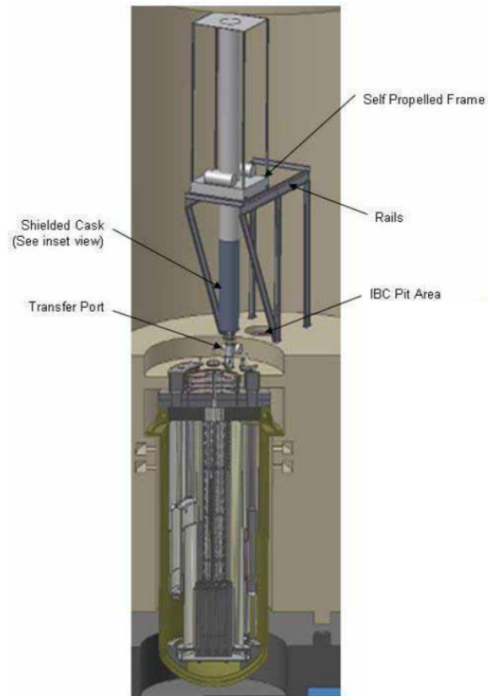


**Figure 32. Pantograph Fuel Handling Machine (PFHM) in the ABTR [2]**



**Figure 33. ABTR fuel storage rack [2].**

core assemblies from the cue position on the storage rack. A shielded door maintains an inert atmosphere in the FUM and shields the surrounding area from radiation from the core assemblies during transport. The FUM provides heating, cooling, and an inert gas atmosphere for transferring fuel assemblies between the core and an IBC. Heated inert argon gas is used to blow off residual sodium during spent fuel assembly removal operations and to return the salt back into the primary vessel.



**Figure 34. ABTR fuel unloading machine [2].**

The IBCs are also a part of the fuel handling system. There are two types of lead shielded inter-building casks. The first type is used for fuel assembly transfers that have had time to decay in the storage rack in the reactor so that no active cooling is required to remove decay heat. The second type of IBC has all the features of the first IBC type and also provides active cooling to maintain core assemblies below a certain temperature for cases in which there would be fuel cladding interaction.

Finally, the intra-building transfer tunnel is the location of the last stage (also the first stage) in the fuel transfer process. The intra-building transfer tunnel is sealed to maintain containment of the reactor facility while transporting IBCs to the fuel cycle facility. The tunnel atmospheric pressure is slightly below the pressure of the reactor building. Each end of the tunnel is sealed with interlocked doors. The tunnel door in the reactor facility is opened to allow an IBC to be brought through from the IBC pit area and placed on the tunnel carriage system. Once the carriage reaches the other end of the tunnel, the door is opened and the IBC is removed. Another empty IBC is transferred to the reactor for reloading, or the door is closed and sealed while the empty carriage returns.

## 9.3 ACCIDENT SCENARIOS

### 9.3.1 FUEL STAGING AND LOADING / POWER PRODUCTION / SHUFFLE OPERATIONS

#### Criticality

- U.1: Incorrect pickup and drop off locations of assemblies by the PFHM → affects criticality/burnup
  - opaqueness of sodium coolant makes inspection and maintenance challenging

#### Heat Removal

- U.2: Assembly decay heat not low enough before PFHM transfer to the transfer position on the rack below FUM (extra shielding/cooling required while transfer out of the core)
- U.3: Shielding doors in the FUM/transfer port cannot close and fuel assembly is stuck in the gaps between doors → inadequate cooling of fuel assembly and high dose in surrounding area behind doors
- U.4: Cask not cooling spent fuel assembly sufficiently while transporting through the intra-building tunnel → inadequate decay heat removal leading to failed assembly
- U.5: Cask stuck on rails in the intra-building tunnel → inadequate decay heat removal of spent fuel assembly

#### Release

- U.6: Accidental water or air ingress through the rotatable plug → release of fission products
- U.7: Loss of inert gas between reactor vessel cover and bulk sodium-free surface → release of fission products
- U.8: PFHM accidentally damages fuel assembly by bumping against adjacent assembly while in motion → release of fission products
- U.9: PFHM accidentally releases fuel assembly prematurely and drops it in the core → release of fission products
- U.10: Corrosion leading to sodium bond breaking in fuel → release of fission products
- U.11: Sodium fire → release of fission products
  - Provide adequate cooling
- U.12: Sodium/concrete reaction in case of spills (when the sodium is being blown off with Ar before being transferred into the IBC) → generation of aerosols and hydrogen leading to concrete ablation
- U.13: Na reaction with H<sub>2</sub>O creates hydrogen gas and NaOH while refueling → extremely corrosive product (NaOH) and H<sub>2</sub> gas is explosive
- U.14: Loss of inert gas while refueling if tight seal not obtained when FUM is lowered through the transfer port → Na reaction with air from residual Na on fuel assembly during transfer
- U.15: Gap between shielding door loses inert gas in the FUM/transfer port → Na reaction with air from residual Na on fuel assembly during transfer
- U.16: Accidental drop of assembly by the FUM in the core → damages assembly in the storage rack while picking up/dropping off the assembly → release of fission products
- U.17: Accidental drop of intra-building cask → damaged assembly and fission product release
- U.18: Inert atmosphere lost in cask during intra-building tunnel transfer → air ingress leading to fire as a result of any residual sodium on the fuel assembly → release
- U.19: Water ingress in cask during intra-building tunnel transfer → leading to Na reaction with water creating hydrogen gas and NaOH

### 9.3.2 ON-SITE DRY CASK STORAGE

- U4.1: Residual sodium not fully removed before IBC containing washed core assembly is moved to the air cell with storage racks awaiting disposition → Na/air reaction
- U4.2: Water ingress into storage container/tank → criticality
- U4.3: Water ingress → production of NaOH and hydrogen gas with any residual Na
- U4.4: Damage to assembly resulting from drop → reduced container array spacing → criticality
- U4.5: Fire → build-up of vapors and pressurization in storage racks → combustion or melting of plugs → venting of gases
- U4.6: Failure of active cooling → increase in temperature which could compromise Na bond in fuel
- U4.7: Failure of passive cooling → increase in temperature which could compromise Na bond in fuel

### 9.4 REFERENCES

- [1] D. E. Burkes, R. S. Fielding, D. L. Porter, D. C. Crawford, and M. K. Meyer. A US Perspective on Fast Reactor Fuel Fabrication Technology and Experience Part 1: Metal Fuels and Assembly Design. *Journal of Nuclear Materials*, 389:458–469, 2009. doi:10.1016/j.jnucmat.2009.02.035.
- [2] Y. I. Chang, P. J. Finch, C. Grandy, J. Cahalan, L. Dietrich, F. Dunn, D. Fallin, M. Farmer, T. Fanning, T. Kim, L. Krajtl, S. Lomperski, A. Moisseytsev, Y. Momozaki, J. Sienicki, Y. Park, Y. Tang, C. Reed, C. Tzanos, S. Wiedmeyer, W. Yang, and Y. Chikazawa. *Advanced Burner Test Reactor Preconceptual Design Report*. Technical Report ANL-ABR-1/ANL-AFCI-173, Argonne National Laboratory, Argonne, IL, 2006. URL: <https://publications.anl.gov/anlpubs/2008/12/63007.pdf>.
- [3] G. Flanagan, T. Fanning, and T. Sofu. *Sodium-cooled Fast Reactor (SFR) Technology and Safety Overview*. <https://www.nrc.gov/docs/ML1504/ML15043A307.pdf>, 2015. Accessed: 2022-12-28.
- [4] N. Hall, X. He, Y-M. Pan, and P. LaPlante. *Storage Experience With Spent (Irradiated) Advanced Reactor Fuel Types*. Technical Report ML20211L885, Center for Nuclear Waste Regulatory Analyses, San Antonio, TX, 2019. URL: <https://adamswebsearch2.nrc.gov/webSearch2/main.jsp?AccessionNumber=ML20211L885>.
- [5] T. L. King, R. R. Landry, E. D. Throm, and J. N. Wilson. *Preapplication Safety Evaluation Report for the Sodium Advanced Fast Reactor (SAFR) Liquid-Metal Reactor*. Technical Report NUREG-1369, U.S. Nuclear Regulatory Commission, 2019. URL: <https://www.nrc.gov/docs/ML0634/ML063410547.pdf>.
- [6] J.-M. Ruggieri, Ren L., J-P. Glatz, I. Ashurko, H. Hayafune, Y. Kim, and R. Hill. *Sodium-Cooled Fast Reactor (SFR) System Safety Assessment, Revision 1*. Technical report, GEN-IV International Forum, 2017. URL: [https://www.gen-4.org/gif/upload/docs/application/pdf/2017-11/gif-sfr-safetyassessment-20170427\\_final.pdf](https://www.gen-4.org/gif/upload/docs/application/pdf/2017-11/gif-sfr-safetyassessment-20170427_final.pdf).

## 10. HEAT PIPE REACTOR

Recent emergence in microreactor concepts have increased because of their ability to provide power to remote areas or military operating bases. There are many different microreactor concepts, but for this work, the HPR was investigated. HPR concepts that have been developed or are currently under development include: (1) the Los Alamos National Laboratory (LANL) Mega-Power reactor which is designed to produce 2 MWe (5 MWth) [2], (2) the INL Design A concept, designed to produce 2 MWe (5 MWth) [2], (3) INL Design B, designed to produce 2 MWe (5 MWth) [2], (4) Westinghouse's eVinci, designed to produce 1 to 4 MWe [3], and (5) OKLO's Aurora, designed to produce 1.5 MWe (4 MWth) [1].

The INL Design A HPR [2] was chosen as the basis for the development of the HPR fuel cycle and served as a major resource to identify potential accident scenarios. Furthermore, because of its use of metallic fuel and metallic coolants, many associated hazards are similar to those found in SFRs (see Chapter 9). Since HPR reactor concepts are very small and modular, higher enriched fuel is required to operate these reactor types, which can impact criticality during storage and transportation of the fuel elements or the core itself. There are new chemicals and processes required to fabricate fuel, all of which introduce unique hazard scenarios. In addition, there is a potential to use reprocessed spent fuel in these types of reactor concepts.

INL Design A introduces unique hazards that may not exist in other microreactor types. The original INL Design A [2] indicates that potassium is used as a coolant in the heat pipes. However, sodium as an alternate coolant in the heat pipes is under consideration for this work. Many of the hazards that arise result from the use of sodium and/or potassium as coolant. Both of these elements being reactive with air, water, and concrete, necessitates the need to handle these materials in inert an environment, where loss of inert gas is a fire/explosion hazard. As a result, inert rooms and cells are expected to be common throughout the reactor system. Remote fuel handling systems have the potential to introduce new challenges and hazard scenarios. And finally, if a sodium bond exists between the metal fuel and the cladding, then this bond could corrode, thus introducing additional hazard scenarios that must be evaluated.

The fuel enrichment, fuel assembly fabrication, and transportation of enriched  $UF_6$  and fuel assemblies is considered in previous chapters (see Chapters 2, 4, and 5).

### 10.1 PLANT AND OPERATION DESCRIPTION

INL Design A is a 5 MWth or 2 MWe reactor concept that is operated for 5 years using HALEU fuel [2]. It has a vertical orientation and contains 1134 fuel elements in the active core (Figure 35 and Figure 36). Open fuel element positions are situated on the periphery of the core. The average fuel element power is 4.41 kW, and the working fluid is potassium in both vapor or liquid phase within the heat pipes. The potassium mass is about 100 g/pipe, and the potassium temperature is expected to reach 675°C. BeO (beryllium oxide) is the material used in the upper and lower reflector regions above and below the fuel elements. The side reflector material is  $Al_2O_3$ .  $B_4C$  is used as a neutron poison in the control drums and as shutdown rods. Stainless steel (SS316) is used to form the heat pipe tubes, inner clad tubes, outer hexagonal clad tubes, and the core barrel.

Although INL Design A has  $UO_2$  fuel, it is assumed that designs licensed in the future will use metallic fuel. Metallic fuel fabrication is covered previously in Section 4.4. As mentioned above, each fuel element contains a solid hexagonal fuel pellet with a central hole (Figure 36). There is stainless steel cladding (SS316) on both sides of the pellet. The fuel elements themselves are independent and unrestrained in the core, which means that they are free to move axially which lowers the thermomechanical stress. The fuel element has azimuthal symmetry about the central steel heat pipe tube and the inner steel cladding, which simplifies the radial stress patterns and results in lower stress levels.

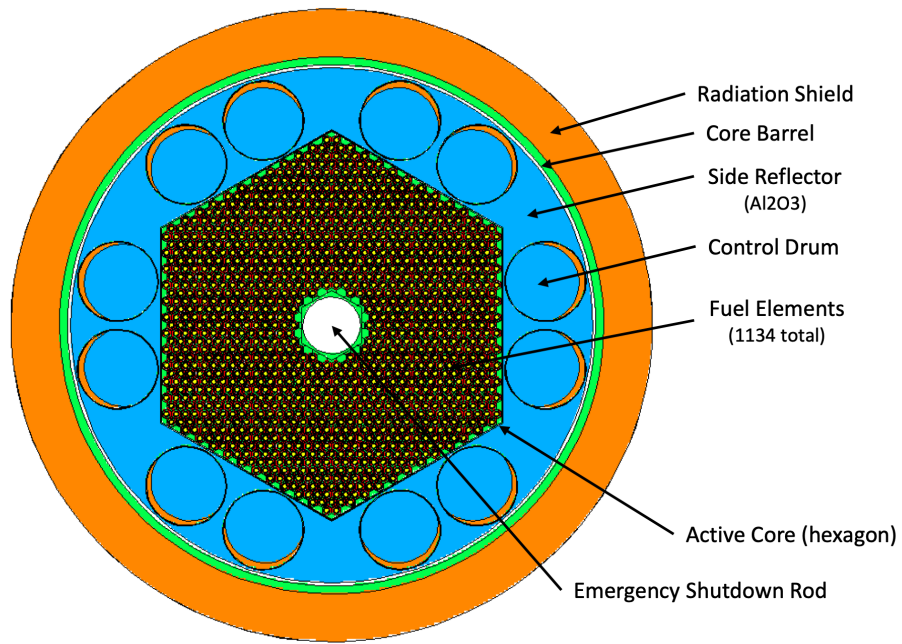


Figure 35. INL Design A core [2].

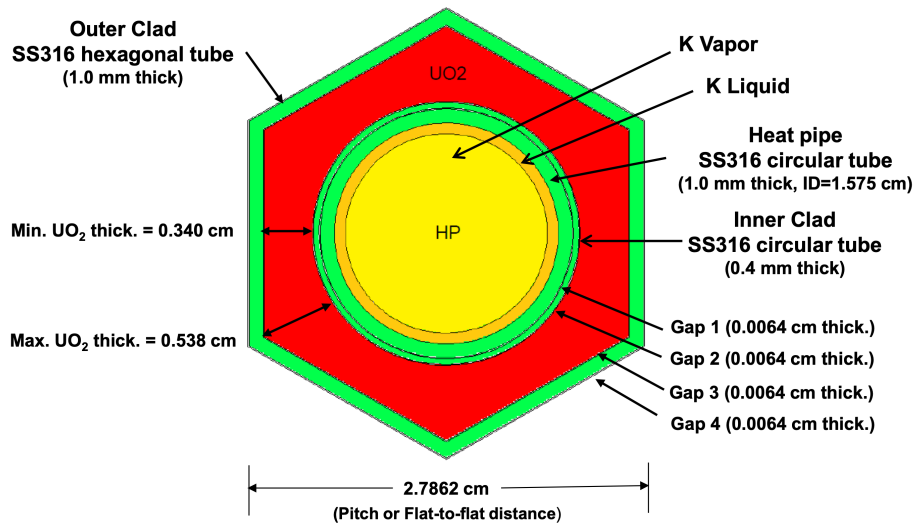


Figure 36. INL Design A fuel element [2].

As shown in Figure 36, four gas gaps are located (1) between the heat pipe and the inner clad, (2) between the inner clad and the fuel pellet, (3) between the fuel pellet and the outer clad, and (4) outside the outer clad. Because of their locations, these gaps have the potential to elevate core temperatures as a result of thermal resistance induced by these gaps. Sterbentz et al. [2] state that the first gap could be eliminated by co-extrusion of the heat pipe and inner clad or by thermally bonding the pipe and clad with a liquid metal like sodium. The second and third gaps will be thermally bonded by using pressurized helium gas or by minimizing the gap widths so that they close by thermal expansion during operating temperatures. The fourth gap can be designed to close by thermal expansion at operating temperatures or through thermal bonding with a liquid metal such as sodium.

Sterbentz et al. [2] state that the heat pipes and associated components can be filled with liquid metal potassium in temperature- and pressure-controlled environments, and they also note that SS316 loses physical strength above 575°C. The HPR is expected to operate between 650 and 750°C. The time-dependent allowable stresses for 316SS are provided by ASME to ensure that operating limits are bounded by these time-dependent allowable stresses. It is also expected that a large number of welds will be required that must meet stringent reliability standards, as “hot cracking” with Type 316 fusion welds is a known issue. In addition, the steel heat pipe and the inner clad walls separate the hot fuel from the heat sink (potassium vapor), and the largest thermal gradient occurs within these heat walls.

## **10.2 ACCIDENT SCENARIOS**

### **10.2.1 FRESH FUEL STAGING AND LOADING**

- U1.1: Fire at the core manufacturing facility → release
- U1.2: Water ingress into critical configuration of fuel rods at the facility → criticality event
- U1.3: Weld failure → inspection does not find weld failure, leading to fuel rod failure.
- U1.4: Temperature- and pressure-controlled environment fails → fire event → release
- U1.5: Beryllium exposure (demonstration purposes only)
- U1.6: Beryllium reflector catches fire during core loading → release (demonstration purposes only)
- U1.7: Water ingress into the heat pipe → potassium/water reaction → release event

### **10.2.2 POWER PRODUCTION**

- U2.1: High operating temperature leading to stainless steel clad failure → fuel rod failure → release event
  - Inner metallic interacts with fuel and cladding and subsequently interacts with vessel wall → confinement structure is challenged
- U2.2: Weld failure at operating temperature → fuel rod failure → release event
- U2.3: Axial expansion too large → fuel rod failure → release event
- U2.4: Inefficient heat transfer between the gaps (blockage) → fuel rod failure → release event
- U2.5: Accidental water ingress into heat pipe → potassium/water reaction → fire → release event
- U2.6: Seismic events → weld failure → reorientation of fuel elements → fuel failure → criticality event
- U2.7: Water/steam ingress into core with weld failures → criticality



- U2.8: Beryllium reflector catches fire → release
- U2.9: Cascading heat pipe failure → heat removal
- U2.10: Leaking of potassium into non-inert atmosphere near the condenser → fire
  - Consider leak paths for non-inert atmosphere scenarios that may occur
- U2.11: Inner heat pipe tubes in the condenser region do not cool because there is not enough natural circulation

### 10.2.3 ON-SITE DRY CASK STORAGE

- U4.1: Water ingress into used core (weld failure) → criticality event
- U4.2: Failed fuel elements → release in storage
- U4.3: Sparks from machinery, equipment or electrical circuits → fire
- U4.4: Sparks from human activities such as welding or smoking → fire
- U4.5: Explosions from potassium/water reactions → fire
- U4.6: Damage to storage tank/cask → fission product release
- U4.7: Collision of storage tank with vehicles or suspended loads → fission product release
- U4.8: Fire resulting from vehicle accident → fuel element fire after shutdown, during reactor transport
- U4.9: Air ingress resulting from weld failure → fire event
- U4.10: Beryllium reflector catches fire → release

### 10.3 REFERENCES

- [1] OKLO. *Part II: Final Safety Analysis Report*. <https://www.nrc.gov/docs/ML2007/ML20075A003.pdf>, 2020. Accessed: 2022-12-28.
- [2] J. W. Sterbentz, J. E. Werner, A. J. Hummel, J. C. Kennedy, R. C. O'Brien, A. M. Dion, R. N. Wright, and K. P. Ananth. *Preliminary Assessment of Two Alternative Core Design Concepts for the Special Purpose Reactor*. Technical Report INL/EXT-17-43212, Idaho National Laboratory, Idaho Falls, ID, 2018. URL: [https://inldigitallibrary.inl.gov/sites/sti/sti/Sort\\_3220.pdf](https://inldigitallibrary.inl.gov/sites/sti/sti/Sort_3220.pdf).
- [3] T. Tweedle. Westinghouse eVinci Micro Reactor, GAIN Workshop. [https://gain.inl.gov/GAINEPRINEI\\_MicroreactorProgramVirtualWorkshopPres/Day-2%20Presentations/Day-2-pm.03-Tweedle-Westinghouse\\_eVinciMRx,18Aug2020.pdf](https://gain.inl.gov/GAINEPRINEI_MicroreactorProgramVirtualWorkshopPres/Day-2%20Presentations/Day-2-pm.03-Tweedle-Westinghouse_eVinciMRx,18Aug2020.pdf), 2020. Accessed: 2022-12-28.



## 11. CONCLUSIONS

Representative nuclear fuel cycles for a HTGR, MSR, pebble-bed FHR, SFR, and HPR were developed based on publicly available information, and potential accident scenarios were identified. Given that the nuclear fuel cycle is not yet established for any of the non-LWR concepts discussed in this report, many assumptions were made based on limited public information. It is anticipated that the details of the fuel cycles will change. It was found that many of the fuel cycles have overlapping hazards and accident scenarios based on their coolant material, fuel component, and their shared need of UF<sub>6</sub> enrichment, transportation of UF<sub>6</sub>, and fuel components.

During UF<sub>6</sub> enrichment and fabrication of the different fuel components (TRISO fuel, fuel pebbles, fissile salt, metallic fuel assemblies), many chemicals are used that have not previously been used in the fabrication for conventional LWR fuel. The main hazards caused by fire and explosions could result in the release of toxic gases. Furthermore, undetected fabrication errors such as large fuel impurities or missing integrity in the TRISO layers will cause problems during utilization stages.

During transportation and storage of containers used to transport enriched UF<sub>6</sub> and fuel components, criticality scenarios with water surrounding the canisters and water ingress into the canisters are considered the major hazards. Furthermore, accidents that cause damage to the containers can cause a release of the transported material followed by potential reactions with air and/or water (for example, UF<sub>6</sub>, fissile salt, and graphite reactions with air/water).

Molten salt spills are a major hazard in reactors that are molten salt-cooled and/or molten salt-fueled, which can cause reactions with concrete (resulting in an explosion from the rapid release of bound water and the production of hydrogen), graphite, water, and air and can also result in generation of toxic and corrosive materials such as HF, F<sub>2</sub>, etc. Depending on the composition of the salt, the release of its beryllium component could be a hazard. In addition to the release of fission, decay, and activation products, the release of tritium, which is generated through reactions in the salt components (Li, F, Be), also can be considered a hazard, especially via tritium diffusion through surfaces in the heat exchanger. Chemistry management of the salt can be implemented to control the redox potential to avoid corrosion of structural components. Breaks in the cover gas or off-gas system can cause fission product release. The high melting point of salt can result in the salt freezing, which can prevent cooling and decay heat removal in the core or in the loop. For the long-term storage of the salt (especially the fuel salt) or other waste products, long-term salt immobilization in waste forms that are mineral-based, glass-based, or a metal-composite is crucial to avoid partial salt decomposition or precipitation of a uranium species over time.

In reactors that use TRISO-fueled pebbles, a major hazard is caused by mechanical failure of pebbles resulting in fission product release. Pebble wear and damage can also generate graphite dust, which is a fire hazard. Graphite reactions with air and water cause graphite oxidation, thus compromising the integrity of the pebbles and retention of the fission product. Because fuel pebbles in HTGRs and FHRs are not individually tracked, accurate measurement of the pebble burnup is required to avoid core misloadings with fresh pebbles or pebbles above the target burnups. Uncertainties in burnup measurements must be assumed for scenarios concerning the reactor's inventory, criticality, and decay heat estimates in the spent fuel storage.

For the metallic-fueled SFR and HPR, major hazards were found to be reactions of sodium and potassium coolants with air, water, and concrete. In SFRs, the use of sodium bond in the fuel rods is a major concern because its corrosion in storage could compromise the containment of fission products within the cladding. Also, if the inert gas atmosphere is lost during the handling of fuel assemblies onsite, residual coolants can cause a strong reaction with air/water that can cause corruption of the fuel rod integrity followed by fission

product release or fire. A major challenge in the operation of SFRs and HPRs is the reliance on I&C when using opaque coolants such as liquid sodium and potassium. This could lead to accidental drop of assemblies or incorrect drop off or pick up locations of assemblies.

Regarding the storage of spent fuel onsite, major hazards are associated with failure of the active or passive cooling and damage to the spent fuel containers causing a release of fission products from damaged spent fuel components.

Based on the comprehensive list of scenarios developed and described in this report, individual scenarios will be selected for the next phase of this project in which code capabilities of SCALE and MELCOR for the modeling and simulation of these scenarios will be demonstrated. The SNL team will continue to develop and use the computer code MELCOR to perform severe accident progression and source term analyses for the selected accident scenarios. The ORNL team will use SCALE to provide MELCOR with the data required to perform the calculation, such as the nuclide inventories and decay heat. The team will also perform further analyses, including criticality and radiation shielding analyses.

**APPENDIX A. METHODOLOGIES FOR HAZARD CONSEQUENCE ANALYSIS WITH  
MELCOR**

## **APPENDIX A. METHODOLOGIES FOR HAZARD CONSEQUENCE ANALYSIS WITH MELCOR**

### **A.1 CONTEXT FOR NON-LWR FACILITY SAFETY MODELING**

MELCOR is a fully integrated, engineering-level computer code with the primary purpose of modeling the progression of accidents in nuclear facilities. It has been broadly applied to the analysis of severe accidents in LWRs, and has been an important analytical capability used by the NRC in a range of rule-making activities. A broad spectrum of accident phenomena in all nuclear reactor concepts and nuclear facilities is treated by MELCOR in a unified framework. Current uses of MELCOR include the following:

- Evaluation of the progression of accidents, and the response of structures, system and components (SSCs) under accident conditions,
- Estimation of fission product and hazardous material release and transport within facility confinements/containments,
- Evaluation of success criteria and fission product source terms for application to risk-informed decision-making, and
- Evaluation of the impact of sensitivities and uncertainties on key metrics relevant to risk-informed decision-making.

MELCOR is applied in the context of facility safety modeling to assess the impact of accidents that have the potential to breach fission product barriers. These types of accidents result in the release of radiological material that could affect the health of on-site personnel or off-site public. In addition to the release of harmful radiological material, accidents at fuel cycle facilities could also result in the release of harmful chemical materials. MELCOR can be utilized to assess the transport of both harmful radiological and chemical materials within facility enclosures.

This section discusses the important models and methodological approaches for applying the MELCOR computer code [3] to facility safety analysis. MELCOR has been applied to a range of analyses to assess safety in nuclear facilities. This has led to the development of a document to describe best practices for modeling nuclear facilities and accidents using MELCOR [5]. This section describes the types of accident scenario classes to which MELCOR is typically applied, the overall manner in which MELCOR is utilized, and the key phenomenological models incorporated into MELCOR that are utilized for facility safety analyses.

It is important to note that the extensive range of phenomenological models already incorporated into MELCOR lead to its being naturally applied to not only traditional facility safety analyses, but also to safety assessment of non-LWR fuel cycle facilities and operations. However, some specific models introduced for non-LWR modeling are relevant to the assessment of facility safety. These include the TRISO fission product release model and the generalized formulation for representing the thermodynamic properties of working fluids different from water (i.e., the generalized equation of state modeling in MELCOR).

### **A.2 ACCIDENT SCENARIO CLASSES**

Several accident scenarios are typically considered for the assessment of safety at facilities processing radiological material. The following scenario classes are commonly considered in developing facility safety bases:

- Criticality event
- Explosion
- Fire

- Material liquid spill / drop of powder material

These scenario classes encompass a broad range of hazards that can occur during operations across the nuclear fuel cycle. They are broadly relevant to the assessment of safety in non-LWR fuel cycle operations. It is important to note, however, that not all of these classes are explicitly considered from the perspective of assessing event consequences. The consequences of a criticality event are not considered when performing hazard consequence assessments.

### **A.2.1 CRITICALITY EVENT**

This event scenario is typically not considered from the perspective of hazard consequence assessment for commercial regulatory evaluation. MELCOR has been applied to assessing the consequences of a criticality event from the perspective of transport and release of a fission product from a facility enclosure [5]. This typically requires a separate characterization of the mass and energy released during such an event, with MELCOR utilized to assess the response of the facility enclosure atmosphere and associated transport of hazardous material (i.e., radionuclides) within the facility enclosure.

In other application areas, such as in DOE facilities, the assessment of consequences arising from a criticality event may be evaluated. The following discussion provides an outline of relevant phenomena for hazard consequence assessment from the perspective of completeness.

However, some aspects of this type of scenario are shared by other event scenario classes. These areas of common phenomenology are identified in the discussions of other scenario classes presented below.

The SCALE package is the tool required to identify whether a configuration of radioactive material can become critical. This package can determine the amount of energy generated as a result of criticality and the available inventory of radionuclides to be released into the compartment atmosphere following the criticality.

From the perspective of subsequent transport of radionuclides through the facility, a nuclear criticality event can be considered primarily as a source of energy addition to a compartment atmosphere. Unlike events involving chemical reactions, gases are typically not released into the compartment atmosphere as a result of a criticality event. However, the inventory of fission products released from the radioactive material into the compartment atmosphere will be altered by the criticality event. Thus, MELCOR must use an inventory generated by SCALE that is appropriate to the specific criticality event.

Both energy and radionuclides can be introduced as MELCOR energy and radionuclide source terms. The MELCOR thermal hydraulic and radionuclide transport packages will then perform transport calculations to determine the radionuclide distribution through the facility and release to the environment.

### **A.2.2 EXPLOSION**

At nuclear facilities, postulated explosions are typically chemical explosions arising from the following:

- Solid explosives
- Combustible liquids (e.g., gasoline)
- Combustible gases (e.g., natural gas or hydrogen)

The impact of an explosion inside an enclosure will depend on explosion type, as described below.

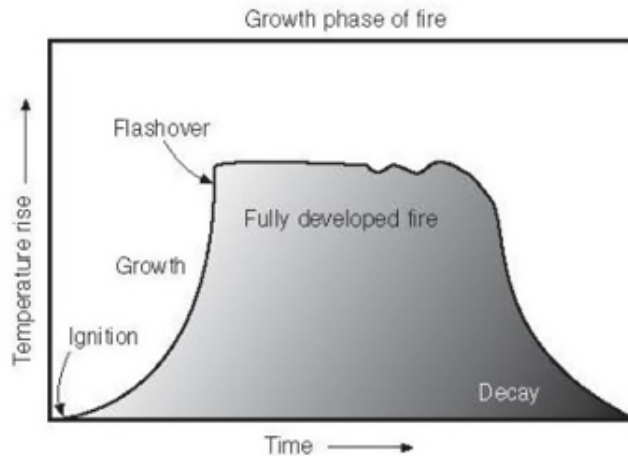
- A deflagration occurs when a combustion front propagates at subsonic speeds. The front propagates at a rate determined by heat transfer from the hot front to the neighboring cold layer: heat transfer from the front to the cold layer is required to heat the cold layer to a temperature that supports combustion.

- A detonation occurs when an exothermic combustion front propagates through a medium at supersonic speeds. This leads to formation of shock front ahead of the combustion front. This type of explosion is often associated with solid or liquid explosives, although there are unique enclosure configurations that can promote detonation of combustible gases. The combustion front associated with a solid or liquid explosive typically propagates at a greater speed than that associated with a gaseous combustion front.

The degree of overpressure generated by an explosive event is a primary consideration when evaluating the impact of the explosion on the enclosure.

### A.2.3 FIRE

Figure 37 shows the typical progression of a fire, thus illustrating the temporal variation of the temperature of the fire. This gives an overall profile of the power being generated by the fire.



**Figure 37. Fire scenario progression.**

As indicated in Figure 37, a fire has the following phases:

- Ignition: the point at which energy is supplied either deliberately or spontaneously to initiate the combustion reaction. Ignition can be evaluated through built-in or input MELCOR models for combustible solid, liquid, or gaseous materials.
- Fire growth: during this phase, the fire spreads across the entire mass of reactants, and the heat release from the fire into the compartment atmosphere typically follows a power law form.
- Steady burning: after the fire is established following the fire growth phase, the fire is sustained through either continued supply of reactants or oxygen. The heat release rate from the fire to the compartment atmosphere and walls during this period can be represented as a radiative heat source.
- Fire decay: as the available combustible material or oxygen becomes limited, the fire decays. Fire suppression systems can also initiate decay of the fire. Generally, fire decay rates of  $10^{\circ}\text{C}/\text{min}$  or  $7^{\circ}\text{C}/\text{min}$  are used when fire duration is less 60 minutes or greater than 60 minutes, respectively.

### A.2.4 SPILLS OR MATERIAL DROPS

A spill of powder or liquid, or a drop of solid radioactive material can result in the dispersal of radioactive material into the atmosphere. In MELCOR, these events can be treated as radionuclide aerosol sources in the radionuclide transport package. The coupled thermal hydraulic and radionuclide packages will determine the distribution of radionuclides throughout the facility and released into the atmosphere.

### A.3 MELCOR APPLICATION

MELCOR was originally developed to support the development of probabilistic risk assessments (PRAs) for nuclear power installations; however, its flexible approach soon led to its use in applications such as in spent fuel pool analyses and package accident analyses. The primary goal of these PRAs is to assess public health and safety risk arising from the release of radioactive material to the environment. This requires assessment of accident progression at a nuclear power plant to characterize the radiological release to the environment in terms of the following factors:

- Timing
- Magnitude
- Composition
- Energy
- Aerosol size distribution

Determination of these characteristics using MELCOR models for radionuclide aerosol and vapor transport within a facility enclosure requires the following processes to be modeled:

- Radionuclide transport
- Radionuclide agglomeration
- Radionuclide deposition

Adequately capturing these processes is essential to determining the above characteristics of release to the environment—the environmental source term from a nuclear power plant accident.

More generally, nuclear facility analysis also considers public health and safety risk arising from release of a broader range of hazardous materials into the environment (i.e., both radioactive and nonradioactive material that can cause harm to humans). The models for treating transport of radionuclides within the enclosure of a facility naturally apply to representation of nonradioactive hazardous material transport. As noted above, transport physics for aerosols and vapors implemented in the MELCOR models is independent of whether or not the material is radioactive or nonradioactive.

The MELCOR code has been applied to safety assessment of US Department of Energy (DOE) facilities in which a concern is the release of airborne hazardous materials. For DOE facilities, this can include both radioactive and nonradioactive materials. However, for DOE facility safety basis analyses, MELCOR's primary application is to develop attenuation factors that represent the degree to which barriers at a facility prevent continued radionuclide transport through the facility into the environment. This analysis is known as a *leak path factor analysis* and is commonly performed for DOE facilities. MELCOR modeling enables an analyst to quantify the leak path factor through its models for transport of radionuclides through a facility and ultimately into the environment. As noted above, the generic nature of MELCOR's modeling of particulate transport does not restrict its use solely to radionuclides: it can also be used to evaluate transport of other types of hazardous material that can pose harm to human health.

The leak path factor enters into the overall algebraic equation for evaluating a source term ( $ST$ ) for a DOE facility [3]:

$$ST = MAR \times DR \times ARF \times RF \times LPF, \quad (A.1)$$

where

- *MAR* = material-at-risk: the amount of material available to be released in an event
- *DR* = damage ratio: the fraction of the material-at-risk actually affected by an accident
- *ARF* = airborne release fraction: the amount of radioactive material that becomes suspended in the atmosphere as an aerosol and thus is available to be transported through the facility and potentially into the environment
- *RF* = respirable fraction: the fraction of airborne radionuclides that can ultimately be inhaled into the human respiratory system
- *LPF* = leak path factor: the fraction of materials released into an enclosure that can ultimately migrate into the environment

The MELCOR models relevant to evaluation of the leak path factor are summarized in Louie and Humphries [5]. MELCOR models are organized into different packages that encapsulate related physical and chemical processes. The principal packages relevant to aerosol and vapor transport within a facility are as follows:

- RN (radionuclide) is the package responsible for characterizing the release and transport of aerosol and vapor species.
- CVH/FL (control volume hydrodynamics - flow path) performs calculations that represent hydrodynamic processes for a range of ambient fluids in liquid, vapor, or gaseous states.

**Table 3. MELCOR modeling of relevant processes during facility accidents**

Package/model	Description/comments
NCG control volume hydrodynamic and flow path model (CVH/FL)	(noncondensable gas package) used to define the gases in control volumes Represents hydrodynamic processes for a range of ambient fluids in liquid, vapor, or gaseous states
HS	(heat structure) Represents heat structures to capture (a) heat transfer between fluids and surfaces in facilities, (b) condensation of condensable gases, and (c) deposition of aerosols
Radionuclide (RN) Counter-current flow model	Tracks aerosols and vapors Performs modeling in MELCOR's CVH/FL package to capture stratified counter-current flow of gases through a flow path between two control volumes
Turbulent aerosol deposition	Modeling in the RN package that represents turbulent deposition of aerosols in a pipe or duct with turbulent gas flow
Filter models	RN package filter modeling that allows representation of a range of different filtration media that can capture aerosol/vapor removal from fluids flowing through the filter
Spray models	The spray (SPR) package was originally developed to represent the effect of sprays within a reactor containment, but its generality supports application to a range of accident scenarios at a facility where sprays may be activated (e.g., sprays emerging from a fire sprinkler system). Sprays have the effect of condensing steam and removing energy from the atmosphere in a facility, and they also scrub aerosols from the atmosphere



## A.4 RELEVANT MELCOR PHENOMENOLOGICAL MODELS

### A.4.1 AEROSOL MODELING

MELCOR was originally developed as a tool to support development of nuclear power plant PRAs. As such, it must account for release of fission products from damaged nuclear fuel, as well as subsequent transport of radioactive fission products within the nuclear power plant. If any of these radioactive fission products were to ultimately be evaluated to be released to the environment in a MELCOR simulation, then the release becomes the source term. This is one major product of the overall accident calculation performed by MELCOR. Source terms are then used to calculate consequences (e.g., consequence to public health and safety in the form of either prompt or latent cancer fatalities), an important component of the PRA. Such processes as thermal hydraulics and core degradation are quantitatively evaluated in a MELCOR simulation to support calculation of the source term.

The RN package in MELCOR calculates the release and transport behavior of fission product vapors and aerosols. As discussed further below, this generic model can capture the transport of nonradioactive vapors and aerosols inside enclosures. It is thus appropriate for use in determining transport of chemically toxic vapors and aerosols that can evolve into the atmosphere of a fuel cycle facility under different accident conditions.

The following discussion focuses on the manner in which MELCOR models the transport of particulates in the form of vapors and aerosols within a facility enclosure. This includes the manner in which these particulates:

- Interact with hydrodynamic fluids inside each of the control volumes defined to represent the facility,
- Deposit or revaporize from heat structures through a range of settling, phoretic, and revaporization processes,
- Condense out of the vapor phase to form aerosols in the enclosure atmosphere, or
- Agglomerate to form increasingly larger aerosols.

Aerosol dynamic processes and the condensation and evaporation of vapors are considered within each MELCOR control volume. The aerosol dynamics models are based on MAEROS [2], a multi-section, multi-component aerosol dynamics code, but without calculation of condensation. Aerosols can deposit directly on surfaces such as heat structures and water pools, or they can agglomerate and eventually fall out once they exceed the largest size specified by the user for the aerosol size distribution. Aerosols deposited on surfaces can be vaporized if they are volatile, but they can only be resuspended if the resuspension model is enabled.

The condensation and evaporation of radionuclide vapors at the aerosol surfaces, pool surfaces, and heat structure surfaces are decoupled from MAEROS. These processes are evaluated by the rate equations from the TRAP-MELT2 code [4], which are based on the surface area, mass transfer coefficients, and the difference between the present surface concentration and the saturation surface concentration.

The steam condensation/evaporation is also decoupled from the MAEROS solution for agglomeration and deposition to reduce the stiffness of the differential equation set. The amount of steam condensed or aerosol water evaporated is calculated by thermodynamics routines called by the CVH/FL package.

Water droplets are transported as fog by the CVH/FL package and are treated as water-class aerosol by the RN package. (Water in pools or condensed on surfaces is not treated by the RN package.) Other radionuclide aerosols and vapors are transported between control volumes by bulk fluid flow of the atmosphere and the pool, assuming zero slip between the radionuclides and the host medium (steam, water, etc.). In addition,

in the absence of bulk flow, aerosols may move by Brownian motion or by gravitational settling through openings between control volumes.

The difference between CVH/FL fog and RN water-class masses in a control volume at the end of the CVH/FL advancement represents net condensation of water onto or evaporation from the aerosols in that volume. The net change in water mass is imposed on the water-class inventory in the RN package, which then uses the Mason equation [6] to distribute the mass change over the aerosol size distribution in the control volume.

Models are available for the removal of radionuclides by pool scrubbing, filter trapping, and containment spray scrubbing. The pool scrubbing model is based on the SPARC code [7], and it treats both spherical and elliptical bubbles. The model includes condensation at the pool entrance, Brownian diffusion, gravitational settling, inertial impaction, and evaporative forces for the rising bubble. Currently, only aerosols are removed by pool scrubbing in the RN package. Water condensation and evaporation are calculated within the CVH/FL package using its own implementation of SPARC modeling. The filter model can remove aerosols and fission product vapors with a specified maximum mass loading. The containment spray model is based on the model in HECTR 1.5 [1], and it removes both vapors and aerosols from the atmosphere.

Chemistry effects can be simulated in MELCOR through the class reaction and class transfer models which are controlled entirely by user-specified parameters. The class reaction process uses a first-order reaction equation to simulate reversible chemical reactions. The class transfer process, which can instantly change the material class or location of a radionuclide mass, can be used to simulate fast, irreversible chemical reactions. With these two processes, phenomena such as adsorption, chemisorption, and other important chemical reactions can be simulated. Only fission product vapors are currently treated with these mechanisms. In addition, chemisorption of radionuclides on surfaces can be simulated with the chemisorption model.

Most intra-volume processes involving radionuclides are calculated first in the RN package, including fission product release, aerosol agglomeration and deposition, fission product condensation and evaporation, distribution of decay heat, and chemical interactions. The effects of these processes are included in the hydrodynamic transport and thermodynamic calculations performed in the CVH/FL package and are executed subsequently.

The transport of fission products is inferred from the transport of hydrodynamic materials, but the CVH/FL package may subcycle during a MELCOR time step. Because radionuclide advection must also abide by the Courant limit, the transport calculations are performed by RN package utility routines called from within the CVH/FL subcycle loop. Part of this transport process includes removal of fission product aerosols and vapors by filters, for example.

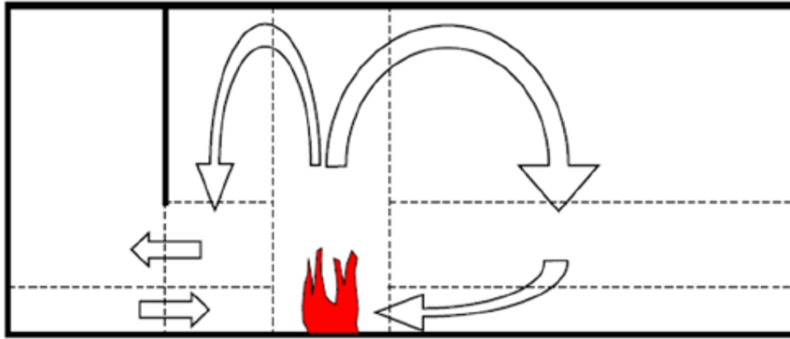
After CVH/FL has advanced through the full MELCOR system time step, the additional intervolumetric process of pool scrubbing is calculated. Although water condensation/evaporation is an intra-volume process, it also is calculated after the CVH/FL package thermodynamics calculations have been performed so that the mass of water condensed in a control volume during the time step is known.

#### **A.4.2 COUNTER-CURRENT FLOW MODEL**

Figure 38 shows the influence of counter-current flows on the overall hydrodynamic response of a facility enclosure in the event of a fire accident scenario. This modeling capability is essential for capturing stratified gas flows between control volumes. As shown in Figure 38, a horizontal flow path between a control volume with a fire and a neighboring control volume exhibits counter-current flow in which the following occur:

- Hot gas from the control volume with the fire flows out through the upper portion of the opening.
- Cooler gas flows into the control volume with the fire through the lower portion of the opening.

This type of flow—in which heat sources in one control volume lead to thermal (i.e., density) gradients between compartments—is essential.



**Figure 38. Counter-current Flows in Fire Scenarios.**

### A.4.3 FILTERS

The MELCOR aerosol transport modeling (RN package) includes models for filter media. These are introduced into a model of a facility as a special flow path between two control volumes. The model allows for a representation of aerosol and vapor removal from the flow passing between two control volumes. To represent a filter in a MELCOR facility analysis, a user typically provides the following information to the input model:

- Flow path where filter is present
- Aerosol/vapor removal efficiency either via
  - Removal efficiency (decontamination factor) that applies uniformly to the aerosols or vapors being tracked <sup>1</sup>
  - Removal efficiencies (decontamination factors) applying uniformly to the different aerosols or vapors being tracked but unique for each discrete particle size bin represented
  - Removal efficiencies (decontamination factors) specific to each aerosol or vapor being tracked
  - Removal efficiencies (decontamination factors) unique to the different aerosols or vapors being tracked and discrete particle size bin represented
- Pre-existing contamination on the filter
- Data to represent thermal desorption (relevant to charcoal filters used to remove vapors)
- Data to represent radiolytic desorption (relevant to charcoal filters used to remove vapors)
- Data to represent charcoal combustion (relevant to charcoal filters used to remove vapors)

### A.4.4 SPRAYS

The objective of the MELCOR spray model has evolved from capturing the impact of engineered spray systems on containment response under reactor accident conditions. Spray action will serve to condense steam, which reduces pressure and temperature in an atmosphere. Sprays will also promote removal of aerosols from the atmosphere.

<sup>1</sup>The different aerosols and vapors being tracked by the particulate transport modeling in MELCOR (RN package) can be specified through user input. The chemical form of the particulate matter being tracked is not specific to fission product aerosols and vapors typically represented for LWR severe accident analyses.

A user can use the MELCOR spray model to represent fire spray systems in a facility. To introduce a spray into an input model for a facility accident, the following parameters can be used to represent a range of configurations:

- Source of water feeding the spray system (i.e., a control volume in MELCOR containing water)
- Sump from which the spray system can draw water to recirculate to the spray headers
- Spray droplet temperature
- Spray droplet flow data
- Spray droplet size distribution
- Flow paths through which spray droplets can fall to other control volumes represented the overall facility

#### A.4.5 RADIATION ENCLOSURE MODEL

MELCOR modeling of heat structures (i.e., structural walls in a facility) is critical to capture:

- Heat sinks that can remove energy from the atmosphere
- Surfaces on which condensable gases or aerosols can condense out of the atmosphere

In addition to a heat structure's interaction with the atmosphere, heat structures can also exchange energy radiatively. As a result, a "hot" heat structure that has a non-zero view factor with a "cold" heat structure can radiatively lose energy. MELCOR supports the definition of networks of heat structures that are coupled to each other radiatively:

- Each network defined by the user can have multiple heat structures.
- All surfaces in a network that exchange radiative heat require specification of view factors between surfaces.
- The beam length between surfaces is user-specified.
- Atmosphere separating surfaces can interact with radiation passing between surfaces such that a gas transmissivity must be specified.

#### A.5 REFERENCES

- [1] S. E. Dingman, A. L. Camp, C. C. Wong, D. B. King, and R. D. Gasser. *HECTR Version 1.5 User's Manual*. Technical Report NUREG/CR-4507, US NRC, Washington, DC, 1986. URL: <https://www.osti.gov/biblio/5736937>.
- [2] F. Gelbard. *MAEROS User Manual*. Technical Report NUREG/CR-1391, US NRC, Washington, DC, 1982. URL: <https://www.osti.gov/servlets/purl/6459120>.
- [3] L. L. Humphries, B. A. Beeny, F. Gelbard, D. L. Louie, J. Phillips, R. C. Schmidt, and N. E. Bixler. *MELCOR Computer Code Manuals Vol. 1: Primer and Users' Guide Version 2.2.18019*. Technical Report SAND2021-0726 O, Sandia National Laboratories, Albuquerque, NM, 2021. URL: <https://www.nrc.gov/docs/ML2104/ML21042B319.pdf>.
- [4] H. Jordan and M. R. Kuhlman. *TRAP-MELT2 User's Manual*. Technical Report NUREG/CR-4205, US NRC, Washington, DC, 1985. URL: <https://www.osti.gov/biblio/5680459>.

- [5] D. Louie and L. L. Humphries. *NSRD-10: Leak Path Factor Guidance Using MELCOR*. Technical Report SAND2017-3200, Sandia National Laboratories, Albuquerque, NM, 2017. URL: <https://www.osti.gov/servlets/purl/1365667>.
- [6] B.J. Mason. *The Physics of Clouds*. Clarendon, Oxford, United Kingdom, 1971.
- [7] P. C. Owczarski and K. W. Burk. *SPARC-90: A Code for Calculating Fission Product Capture in Suppression Pools*. Technical Report NUREG/CR-5765, US NRC, Washington, DC, 1991. URL: <https://www.osti.gov/biblio/6120360>.

**APPENDIX B. SCALE METHODS FOR CRITICALITY, INVENTORY, AND SHIELDING**

## **APPENDIX B. SCALE METHODS FOR CRITICALITY, INVENTORY, AND SHIELDING**

This section briefly introduces the major modules of the SCALE code system [11] to be used for criticality, nuclide inventory, and shielding calculations for selected accident scenarios in the non-LWR fuel cycles.

### **B.1 CRITICALITY**

Multiple neutron transport kernels are available in SCALE for criticality calculations in multigroup (MG) and continuous-energy (CE) calculations. Among those kernels, there are three Monte Carlo codes that can be used in MG and CE mode: KENO-V.a, KENO-VI, and Shift. Shift is a new Monte Carlo code that has been made available with the SCALE 6.3 release [7]. Shift has additional capabilities compared to KENO. It has the capability to automatically place TRISO particles at random locations, for example, within a HTGR or FHR pebble [6]. Furthermore, Shift has an excellent performance when used with massive parallelization, which can reduce runtime. SCALE's other unique capability for double-heterogeneous systems (such as for TRISO particles distributed in fuel pebbles) is a special cross section self-shielding treatment implemented in SCALE's cross section processing code XSProc for MG calculations which allows for rapid neutron transport calculations that are up to a factor of 25 faster than fully detailed CE calculations for these complex systems [2].

The calculations performed for this project will be performed with Shift or KENO-VI, invoked by SCALE's Criticality Safety Analysis Sequence (CSAS). CSAS automatically performs the required nuclear data processing (including the self-shielding for MG calculations), calls the requested neutron transport kernel, and collects the results.

### **B.2 INVENTORY GENERATION**

Radionuclide inventory can be obtained with SCALE in various ways. ORIGEN is the depletion and decay solver in SCALE which can be used standalone. For inventory calculations based on explicitly defined 1D, 2D, or 3D models, the reactor physics sequence TRITON can be used. Rapid inventory calculations based on pregenerated ORIGEN cross section libraries can also be obtained through the ORIGAMI code.

It is noted that a second reactor physics sequence, Polaris, is optimized for LWR assembly depletion calculations. Because of the focus on LWR assemblies, this sequence is not applied in this project.

#### **B.2.1 TRITON**

The time-dependent transmutation of various materials in 1D, 2D, or 3D models can be calculated with the reactor physics sequence TRITON [3, 11]. TRITON coordinates the nuclear data processing, the neutron transport calculations for 1D, 2D, and 3D configurations, and the depletion and decay to estimate the isotopic concentrations of depleted mixtures, mixture-wise power and burnup, neutron flux, and other quantities as a function of burnup. The cross-section processing prepares MG or CE cross sections for the neutron transport calculation. The neutron transport calculation results in material-wise collapsed 1-group fission and removal cross sections and energy-dependent flux which are transferred together with the material compositions to the depletion solver for the depletion or decay calculation. The material compositions are then updated, and the next neutron transport calculation is run. For the cross-section processing, TRITON invokes the XSProc module; for depletion and decay, TRITON invokes ORIGEN; and for the neutron transport calculations, TRITON can be used in combination with SCALE's deterministic 1D XSDRN and 2D NEWT solvers and the 3D Monte Carlo codes KENO-V.a, KENO-VI, and Shift.

## B.2.2 ORIGEN

Oak Ridge Isotope Generation code (ORIGEN) solves the Bateman equations to calculate time-dependent concentrations, activities, and radiation source terms for a large number of isotopes considering generation or depletion by neutron transmutation, fission, and radioactive decay [5, 11]. ORIGEN is used within TRITON and Polaris to perform depletion and decay, or it can be used as a stand-alone SCALE module to (1) simulate continuous nuclide feed and chemical removal, which can be used to model reprocessing or liquid fuel systems, and (2) to generate alpha, beta, neutron and gamma decay emission spectra. A standard decay library is available for decay calculations. ORIGEN can also be used to perform neutron activation calculations by using problem-dependent neutron spectrum-dependent ORIGEN libraries created from (1) user-defined spectrum and self-shielded cross sections using the COUPLE module in SCALE, or (2) interpolation of existing ORIGEN reactor libraries (precalculated by TRITON) using the automated rapid processing (ARP) module.

## B.2.3 ORIGAMI

ORIGAMI is another module available within SCALE that can be used to perform interpolation of 1-group cross section libraries that are pre-generated at varying burnup intervals, fuel enrichment, moderator densities, and so on, for performing rapid depletion calculations [10, 11]. The ORIGAMI workflow allows users to compute detailed isotopic compositions for LWR assemblies (PWR and BWR in SCALE 6.3), and more recently, flowing pebble-bed systems (in SCALE 7.0) can be computed very rapidly by avoiding detailed transport calculations for each step.

In the case of LWRs, the fuel can be modeled using either lumped or pin-wise representations with the option of including axial zones. ORIGEN burnup calculations are then performed for each of the specified power regions to obtain the spatial distribution of isotopes in the burned fuel. ORIGAMI also allows for depletion calculations involving multiple cycles with varying burn times and down times. Recent work included the extension of ORIGAMI for pebble-bed reactors (PBRs) [9]. For PBRs, ORIGAMI models the depletion of a pebble via a series of transits through in the core. Axial transit zones are defined to be comprised of multiple radial zones, and multiple transit zones are stacked to represent full core. The relative probability of a pebble being located within one of the radial zones within an axial zone is provided through an input parameter. Once a pebble enters the core, it is assumed that it remains within the radial zone. ORIGAMI calculates the time-dependent inventory of pebbles by following their transit through the stacked axial zones given their radial distribution. Multiple passes through the core can be simulated to model the complete lifetime of fuel pebbles in a given core.

## B.3 SHIELDING

Monaco with Automated Variance Reduction using Importance Calculations (MAVRIC) is a shielding sequence in SCALE designed to enable 3D automated variance reduction for deep-penetration/shielding problems [8, 11]. The automated variance reduction is based on Consistent Adjoint Driven Importance Sampling (CADIS) and Forward-Weighted-CADIS (FW-CADIS) methodologies.

CADIS is used to optimize a tally of user interest in a Monte Carlo calculation. In this workflow, Denovo [4], a 3D deterministic code, is used to create a particle importance map to determine the areas of a problem that are most important for tallying particles in a region of user interest. This importance map is established by using weight windows and a biased source distribution to ensure that tracking is optimized for particles of importance to the user-specified tally. MAVRIC automates the generation of the importance map and biased source by executing Denovo, and then MAVRIC subsequently runs the fixed-source Monte Carlo code Monaco. The CADIS methodology is extended to FW-CADIS to allow users to optimize for multiple tallies or mesh tallies (instead of one tally in the case of CADIS) so that large areas of a problem can be



optimized for particle transport and tallying in Monte Carlo simulations. MAVRIC-Shift is a new radiation shielding sequence that supports parallel execution of the Monte Carlo calculation with Shift instead of the serial execution enabled in Monaco [1].

## B.4 REFERENCES

- [1] K. Banerjee, C. Celik, G. G. Davidson, T. M. Evans, B. T. Rearden, and W. A. Wieselquist. *The MAVRIC-Shift Sequence in SCALE for Radiation Transport and Shielding Calculations with Automated Variance Reduction and Parallel Computing*. Technical Report ORNL/TM-2019/1358, Oak Ridge National Laboratory, Oak Ridge, TN, 2019. URL: <https://info.ornl.gov/sites/publications/Files/Pub133239.pdf>.
- [2] F. Bostelmann, C. Celik, M. L. Williams, R. J. Ellis, G. Ilas, and W. A. Wieselquist. SCALE Capabilities for High Temperature Gas-Cooled Reactor Analysis. *Annals of Nuclear Energy*, 147:107673, 2020. doi:10.1016/j.anucene.2020.107673.
- [3] M. D. De Hart and Stephen M. Bowman. Reactor Physics Methods and Analysis Capabilities in SCALE. *Nuclear Technology*, 174(2):196–213, 2011. doi:10.13182/NT174-196.
- [4] T. M. Evans, A. S. Stafford, R. N. Slaybaugh, and K. T. Clarno. Denovo: A New Three-Dimensional Parallel Discrete Ordinates Code in SCALE. *Nuclear Technology*, 171(2):171–200, 2010. doi:10.13182/NT171-171.
- [5] I. C. Gauld, G. Radulescu, G. Ilas, B. D. Murphy, M. L. Williams, and Dorothea Wiarda. Isotopic Depletion and Decay Methods and Analysis Capabilities in SCALE. *Nuclear Technology*, 174(2):169–195, 2011. doi:10.13182/NT11-3.
- [6] T. M. Pandya, F. Bostelmann, M. A. Jessee, T. Ghaddar, P. Britt, and S. Johnson. *Modeling, Performance Assessment, and Nodal Data Analysis of TRISO Fueled Systems with Shift*. Technical Report ORNL/TM-2022/2601, Oak Ridge National Laboratory, Oak Ridge, TN, 2022. URL: <https://info.ornl.gov/sites/publications/Files/Pub183158.pdf>.
- [7] T. M. Pandya, S. R. Johnson, T. M. Evans, G. G. Davidson, S. P. Hamilton, and A. T. Godfrey. Implementation, Capabilities, and Benchmarking of Shift, a Massively Parallel Monte Carlo Radiation Transport Code. *Journal of Computational Physics*, 308:239–272, 2016. doi:10.1016/j.jcp.2015.12.037.
- [8] G. Radulescu, C. Celik, and P. Stefanovic. Overview of ORNL SCALE Shielding Analyses for Spent Nuclear Fuel Transportation and Storage Applications. In *Proceedings of the 14<sup>th</sup> International Conference on Radiation Shielding and 21st Topical Meeting of the Radiation Projection and Shielding Division*, 2022. URL: [doi.org/10.13182/ICRSRPSD22-39456](https://doi.org/10.13182/ICRSRPSD22-39456).
- [9] S. E. Skutnik, F. Bostelmann, and W. A. Wieselquist. Rapid Depletion Analysis of Flowing-Pebble Reactor Systems at Equilibrium using SCALE. In *International Conference on Physics of Reactors 2022 (PHYSOR 2022)*, 2022. URL: <https://www.osti.gov/servlets/purl/1871117>.
- [10] S. E. Skutnik, M. L. Williams, and R.A. Lefebvre. ORIGAMI: A New Interface for Fuel Assembly Characterization with ORIGIN. In *IHLRWM 2015, Charleston, SC, April 12–16*, 2015.
- [11] W. A. Wieselquist and R. A. Lefebvre (Eds.). *SCALE 6.3.1 User Manual*. Technical Report ORNL/TM-SCALE-6.3.1, Oak Ridge National Laboratory, Oak Ridge, TN, 2023.

